

Accessories and Suspension

CATALOGUE AND PRICE LIST

Effective 1 December 2022



RETAIL

VOLUME 22



Warranty Periods

Full warranty terms and conditions are located on page 482 of this Catalogue

PLEASE NOTE:

No Warranty Claims or Goods Returned will be accepted unless accompanied by a completed WARRANTY CLAIM / GOODS RETURN FORM.

| Category | Product Group | Warranty - 1 Dec. 2022 Onwards | Notes |
|---|---------------------------------|--|--------------------------------|
| Front, Rear, Underbody, and Side Protection Products | Bullbars | 3 Year | Excl Third Party Colour Coding |
| | Side Steps /Rails | 3 Year | Excl Third Party Colour Coding |
| | Underbody Protection | 3 Year | |
| | Rated Recovery Points | 3 Year | |
| | Monster Winches | 5 Year - Mechanical 1 Year - Electrical | |
| | Towbars | 3 Year | |
| Electrical | Vehicle Lighting | 3 Year | |
| | Vehicle Power | 3 Year | |
| Alu-Cab Products | Alu-Cab | 1 Year - Moving Parts | 3 Years Structural |
| Roof Racks | Steel and Alloy Mesh Roof Racks | 3 Year | |
| | Atlas Roof Racks | 5 Year | |
| Ute Tub | Slide-Away | 3 Year | |
| | Canopies | 3 Year | Excl Third Party Colour Coding |
| | Drawer Systems | 2 Year | |
| Other Products | Camping Furniture | 1 Year | |
| | Fender Flares | 1 Year | |
| | Ice-Cube Fridges | 3 Year - Components 5 Year - Compressor | |
| | Maxi Cases / Storage | 2 Year | |
| | Outdoor Lifestyle Products | 1 Year | |
| | Portable LED Lighting | 1 Year | |
| | Portable Power Products | 2 Year | |
| | Reco-Traks | Limited Lifetime | |
| | Recovery Equipment | 2 Year | |
| | Roof Bags | 1 Year | |
| | Seat Covers / Interior | 1 Year | |
| | Snorkels | 5 Year | |
| | Tents, Awnings and Swags | 2 Year | |
| | Tyre Repair | 3 Year | |
| | Water Tanks and Accessories | 2 Year - Tanks 1 Year - Pumps and Accessories | |
| Suspension | Suspension | 4 Year | Unlimited km |
| | GVM Upgrades | 2 Year | up to 40,000km |
| | Load Plus | 2 Year | Unlimited km |

All suspension products must undergo a safety check at 500km after fitment. Fitment should be performed by an authorised or licensed mechanic, competent with suspension installations. Special tools may be required when fitting some parts including struts. Damage to products through fitment error is not covered under warranty. Warranty may become void when product is installed in conjunction with anything other than genuine manufacturer or Ironman 4x4 components.

Where required, Ironman 4x4 recommend wheel alignment after fitment of any new suspension component. Obtaining wheel alignments is the responsibility of the buyer.

FREIGHT CONDITIONS: Freight of all products is the buyer's responsibility. Where Ironman 4x4 have arranged freight, costs involved will be invoiced to the buyer. Ironman 4x4 is not responsible for damage or loss during freight.

FITTING: All prices listed may be subject to fitting costs. The price of fitting is determined by the individual fitting agent.

Pricing subject to change without notice.

For further information please contact us on 1300 731 137 or email info@ironman4x4.com.

The names and reference numbers of manufacturers and suppliers other than Ironman 4x4 Pty Ltd used in this product catalogue are shown only to assist our customers in identifying replacement parts. Under no circumstances does Ironman 4x4 Pty Ltd imply that the parts sold by Ironman 4x4 are those of the OE manufacturers. Although care has been taken to ensure accuracy of data contained in this publication, Ironman 4x4 Pty Ltd does not assume any liability for errors or omissions.

©Copyright 2022 Ironman 4x4 Pty Ltd. No part of this publication may be reproduced or replicated without the prior written consent of Ironman 4x4 Pty Ltd.



| | |
|--|---|
| 4WD AND TOURING GEAR PRODUCT |  |
| ACCESSORIES AND SUSPENSION PRODUCT BY VEHICLE |  |
| ACCESSORY AND SUSPENSION SPARE PARTS |  |
| PRODUCT INSTALL TIMES GUIDE |  |
| GVM UPGRADES |  |
| SUSPENSION SELECTION INFORMATION |  |
| SUSPENSION TECHNICAL SPECIFICATIONS |  |
| ACCESSORY SELECTION INFORMATION |  |
| ACCESSORY TECHNICAL SPECIFICATIONS |  |
| PRODUCT CODE QUICK REFERENCE |  |

Contents - Accessories to Suit

4WD AND TOURING GEAR

RECOVERY EQUIPMENT

| | |
|---|-------|
| Electric Winches and Accessories | 10 |
| Recovery Kits, Straps and Accessories | 10-11 |
| Compressors | 12 |
| Tyre Accessories and Lifting Jacks | 12 |
| Recovery Boards | 13 |
| Multi-Purpose Rear Wheel Bag | 13 |
| Seat Covers | 13 |
| Anchor Track | 13 |

CAMPING ACCESSORIES

| | |
|---------------------------|----|
| Camp Chairs | 14 |
| Camp Tables | 14 |
| Swags and Stretches | 15 |
| Sleeping Bags | 15 |
| Toilets and Showers | 16 |
| Camp Steps | 16 |
| Camp Kitchen | 17 |
| Camp Tools | 17 |
| Cleaning | 17 |
| Torches and Fans | 18 |
| Camp Lighting | 18 |
| Camp Power | 19 |
| Solar | 19 |

FRIDGE / FREEZERS

| | |
|--------------------------|----|
| Fridge / Freezers | 20 |
| Fridge Slides | 21 |
| Fridge Accessories | 21 |

CAMPING

| | |
|---|-------|
| Rooftop Tents | 22-23 |
| Rooftop Tent Accessories | 22-23 |
| DeltaWing 270° Awnings | 24-25 |
| DeltaWing 270° Awning Accessories | 25 |
| Instant Awnings | 26 |
| Awning Xtra Weathershield | 26 |
| Awning Quick Release | 26 |
| Room Enclosures | 26 |
| Instant Ensuite | 26 |

DRIVING LIGHTS

| | |
|---------------------------------|-------|
| LED Driving Lights | 27 |
| LED Lightbars | 28-29 |
| Driving Light Accessories | 29 |
| Universal LED Work Lights | 30 |
| Bull Bar Cube Lights | 30 |
| Light Wiring Looms | 31 |

AUTO ELECTRICAL

| | |
|----------------------------|----|
| Auto Electrical | 31 |
| Dual Battery Systems | 31 |

STORAGE

| | |
|--|----|
| Single Drawer Systems | 32 |
| Twin Drawer Systems | 32 |
| Wing Kits | 32 |
| Fridge Slides | 21 |
| Water Tanks | 33 |
| Maxi Cases | 34 |
| Aluminium Tool Box | 34 |
| Steel Truck Boxes | 34 |
| Rooftop Bags | 36 |
| Rooftop Tent Hanging Bags / General Camping Bags | 35 |

ROOF RACKS

| | |
|--|-------|
| Atlas Roof Racks and Accessories | 36-37 |
| Alloy Roof Racks | 38 |
| Steel Roof Racks | 38 |
| Universal Roof Rail Extrusions | 38 |
| Mounting Kits | 38 |

FLEET AND MINING

| | |
|------------------------------------|----|
| Fleet and Mining Accessories | 39 |
|------------------------------------|----|

APPAREL

| | |
|---------------------|----|
| T-Shirts | 40 |
| Baseball Caps | 40 |

MERCHANDISE

| | |
|-------------------------------|----|
| Ironman 4x4 Merchandise | 41 |
|-------------------------------|----|

ACCESSORIES TO SUIT (BY VEHICLE)

FIAT

| | |
|----------------------|----|
| Fullback 2016+ | 45 |
|----------------------|----|

FORD

| | | |
|----------|---|-----|
| Everest | UAII 7/2018+ | 67 |
| | 9/2015 to 6/2018 | 69 |
| F150 | 2015 to 2020 | 48 |
| Maverick | 1988 to 1994 (See Nissan Patrol Page 228) | 228 |
| Ranger | Raptor 9/2018+ | 49 |
| | Next-Gen 2022+ | 50 |
| | PX Mk III 8/2018+ | 52 |
| | PX Mk II 2015 to 7/2018 | 56 |
| | PX 7/2011 to 2015 | 60 |
| | PJ / PK 2006 to 2011 | 64 |

GM / CHEVROLET / HOLDEN

| | | |
|------------|----------------------------|----|
| Colorado | RG 11/2016 to 2020 | 80 |
| | RG 2012 to 10/2016 | 83 |
| | RC 7/2008 to 12/2012 | 87 |
| Colorado 7 | RG 2012+ | 78 |
| Rodeo | RA7 2007 to 7/2008 | 89 |
| | RA 2002 to 2006 | 91 |
| Silverado | 1500 2019+ | 71 |
| Traiblazer | LT / LTZ 2017+ | 76 |

GREAT WALL UTE

| | | |
|--------|---------------|----|
| Cannon | 9/2020+ | 94 |
|--------|---------------|----|

HYUNDAI

| | | |
|-------|-------------|----|
| iLoad | 2016+ | 97 |
|-------|-------------|----|

ISUZU

| | | |
|-------|------------------------|-----|
| D-Max | 8/2019+ | 98 |
| | 2/2017 to 7/2019 | 101 |
| | 6/2012 to 1/2017 | 104 |
| | 2007 to 6/2012 | 108 |
| MU-X | 8/2021+ | 110 |
| | 2013 to 7/2021 | 110 |
| | 2014 to 7/2021 | 110 |

JEEP

| | | |
|----------------|-------------------|-----|
| Gladiator | JT 4/2019+ | 118 |
| Grand Cherokee | WK2 8/2013+ | 120 |
| Wrangler | JL 2018+ | 124 |
| | JK 2007+ | 126 |

LAND ROVER

| | | |
|-----------|-------------------------|-----|
| Defender | 2007-2016 | 133 |
| Discovery | Series 2, 3 and 4 | 138 |

LDV

| | | |
|-----|-------------------------------|-----|
| T60 | 2.8L Turbo Diesel 2017+ | 142 |
|-----|-------------------------------|-----|

MAZDA

| | | |
|-------|-------------------------|-----|
| BT-50 | 6/2020+ | 147 |
| | 2012 to 5/2020 | 150 |
| | J97M 2006 to 2012 | 154 |



Contents - Accessories to Suit

MITSUBISHI

| | | |
|--------------|-------------------------------------|-----|
| Pajero | NW-NX 2011 | 166 |
| | NM, NP, NS, NT 5/2000 to 2011 | 167 |
| Pajero Sport | 7/2019+ | 162 |
| | 11/2016 to 6/2019 | 164 |
| Triton | MR 11/2018+ | 178 |
| | MQ 2015 to 10/2018 | 182 |
| | MN 2009 to 2015 | 187 |
| | ML 2006 to 2009 | 190 |

NISSAN

| | | |
|------------|---|-----|
| Navara | NP300 Series 5 2021+ | 197 |
| | NP300 2015 to 2020 | 200 |
| | D40 2005+ | 203 |
| | D22 2002+ | 206 |
| Pathfinder | R51 2005 to 2013 | 210 |
| Patrol | Y62 2020+ | 216 |
| | Y62 2010 to 2019 | 216 |
| | Y61 GU Series 4 2005+ | 218 |
| | Y61 GU Series 1-3 1998 to 2004 | 219 |
| | Y60 GQ Station Wagon 1987 to 1997 | 228 |
| | Y60 GQ Coil Cab 1987 to 1997 | 228 |

RAM

| | | |
|------|------------------|-----|
| 1500 | DT 6/2018+ | 238 |
| | DS 2014+ | 239 |

RENAULT

| | | |
|---------|-----------------------------|-----|
| Alaskan | Thai-Built Only 2017+ | 240 |
|---------|-----------------------------|-----|

SSANGYONG

| | | |
|--------|---------------------|-----|
| Musso | Q200 10/2018+ | 243 |
| | Q201 10/2018+ | 243 |
| | Q205 10/2018+ | 243 |
| | Q215 10/2018+ | 243 |
| Rexton | Y400 10/2018+ | 248 |

SUZUKI

| | | |
|--------------|----------------------|-----|
| Jimny | GJ 2018+ | 254 |
| | 2012 to 1/2019 | 256 |
| Grand Vitara | 8/2005 to 2015 | 260 |

TOYOTA

| | | |
|-------------|--|-----|
| 4Runner | Gen 5, N280 2009+ | 264 |
| FJ Cruiser | 2006+ | 270 |
| Fortuner | 2015+ | 272 |
| Hilux | 8/2020+ | 278 |
| | Revo 5/2018 to 7/2020 | 282 |
| | Revo 2015 to 4/2018 | 282 |
| | Vigo 2011 to 2015 | 286 |
| | Vigo 2005 to 2011 | 286 |
| | Tiger 1997 to 2004 | 290 |
| Landcruiser | 300 Series 2022+ | 294 |
| | 200 Series (Facelift) 11/2015+ | 296 |
| | 200 Series 2/2012 to 10/2015 | 298 |
| | 200 Series 11/2007 to 1/2012 | 298 |
| | 105 Series HZJ105, FZJ105 | |
| | Live Axle Front Suspension 3/1998 to 10/2007 | 300 |
| | 100 Series HDJ100, UZJ100 | |
| | Independent Front Suspension 3/1998 to 10/2007 | 303 |
| | 80 Series HZJ80, FZJ80 1990 to 1998 | 305 |
| | 79 Series (V8 TD) Single Cab 9/2016+ | 308 |
| | 79 Series (V8 TD) Single Cab 2007 to 8/2016 | 308 |
| | 79 Series Single Cab 1999 to 2007 | 308 |
| | 79 Series Dual Cab 11/2012+ | 311 |
| | 78 Series Troop Carrier 2007+ | 315 |
| | 78 Series 1999 to 2007 | 319 |
| | 76 Series 2007+ | 323 |
| | 75 Series 1984 to 1999 | 326 |
| | 60 Series 11/1980 to 11/1989 | 332 |

TOYOTA - Continued

| | | |
|--------|--------------------------------------|-----|
| Prado | 150 Series (Facelift) 11/2017+ | 340 |
| | 150 Series 11/2013 to 10/2017 | 343 |
| | 150 Series 11/2009 to 10/2013 | 343 |
| | 120 Series 4/2003 to 10/2009 | 346 |
| | 95 Series 1996 to 10/2002 | 348 |
| | 90 Series 1996 to 10/2002 | 348 |
| Tacoma | 2005+ | 350 |
| Tundra | 2013 to 2020 | 352 |
| Amarok | V6 11/2016+ | 358 |
| | 2011 to 10/2016 | 360 |

SPARE PARTS

| | | |
|---------------------------|-------|-----|
| Bull Bars | | 364 |
| Canopies | | 365 |
| Canopy / Roof Racks | | 368 |
| Driving Lights | | 368 |
| Fridges | | 368 |
| Instant Awnings | | 368 |
| Miscellaneous | | 372 |
| Rooftop Tents | | 369 |
| Slide-Away Tonneau Covers | | 369 |
| Snorkels | | 370 |
| Suspension | | 370 |
| Swags | | 371 |
| Tow Bars | | 371 |
| Underbody Protection | | 371 |
| Winches | | 371 |

ACCESSORY INSTALLATION FITTING TIMES

| | |
|---|-----|
| Approximate Accessory Fitting Times | 373 |
|---|-----|

ACCESSORIES PRODUCT INFORMATION

| | |
|-----------------------------|-----|
| Features and Benefits | 434 |
|-----------------------------|-----|

ACCESSORIES TECHNICAL SPECIFICATIONS

| | |
|---|-----|
| Monster Winches | 440 |
| Bull Bars | 440 |
| Rear Tow Bars | 442 |
| Side Steps / Rails | 442 |
| Rated Recovery Points | 442 |
| Snorkels | 444 |
| Underbody Protection | 445 |
| Roof Racks and Accessories | 446 |
| Canopies | 447 |
| Driving Lights | 448 |
| LED Worklights | 449 |
| LED Lightbars | 450 |
| Wire Looms | 451 |
| Fridge / Freezers | 452 |
| Fridge / Freezer Troubleshooting | 452 |
| Locksafe Drawer Systems | 454 |
| DeltaWing 270° Awnings | 455 |
| Rooftop Tents | 456 |
| Rooftop Tent and Awning Accessories | 458 |
| Swags | 459 |
| Water Tanks | 460 |

QUICK REFERENCE INDEX

| | |
|------------------------------|-----|
| Product Code Reference | 461 |
|------------------------------|-----|

TERMS AND CONDITIONS

| | |
|-------------------------------------|-----|
| Terms and Conditions of Trade | 482 |
|-------------------------------------|-----|

Contents - Suspension to Suit

SUSPENSION TO SUIT (BY VEHICLE)

| | |
|--------------------------------------|---|
| DACIA | |
| Duster | 2010+ 44 |
| FIAT | |
| Fullback | 2016+ 46 |
| FORD | |
| Courier | Ranger (not USA model) 1985 to 2006 66 |
| Everest | UA11 7/2018+ 68 |
| | 3.2L 2015 TO 6/2018 70 |
| Maverick | 1988 to 1994 (See Nissan Patrol Page 229) 229 |
| Ranger | Raptor 9/2018+ 49 |
| | Next-Gen 2022+ 51 |
| | PX Mk III (not USA model) 7/2018+ 54 |
| | PX Mk II (not USA model) 2015 to 6/2018 58 |
| | T6 PX (not USA model) 2011 to 2015 62 |
| | PJ / PK (not USA model) 3/2006 to 2011 65 |
| GM / Holden | |
| Colorado | RG 2016 to 2020 81 |
| | RG 2012 to 2016 84 |
| | RG Low Ride 2WD 2012+ 86 |
| | RC 2003 to 2012 88 |
| Colorado 7 | Trailblazer 2012+ 79 |
| Frontera | 1995 to 1/1999 75 |
| Jackaroo | Bighorn / Monterey 1992+ 72 |
| | 11/1986 to 1991 73 |
| | Pre 1996 74 |
| Rodeo | RA 2003 to 2012 90 |
| | RA7 2003 to 2012 90 |
| | KB - TFS 1988 to 3/2003 92 |
| | KB - TF 1983 to 1988 93 |
| Trailblazer | LT / LTZ 2017+ 77 |
| GREAT WALL UTE | |
| Cannon | 9/2020+ 94 |
| HAVAL | |
| H9 | Wagon 2.0L Petrol 8/2017+ 95 |
| HYUNDAI | |
| Terracan | 2001+ 97 |
| ISUZU | |
| D-Max | 8/2019+ 99 |
| | 2016 to 7/2019 102 |
| | 6/2012 to 1/2017 105 |
| | Low Ride 2WD 2012+ 107 |
| | 2003 to 2012 109 |
| MU-X | 8/2021+ 111 |
| | 2013 to 7/2021 111 |
| Trooper | 1992+ 112 |
| | 11/1986 to 1991 113 |
| | Pre 1986 114 |
| JEEP | |
| Cherokee | Liberty KK 2007 to 2012 115 |
| | Liberty KJ 2001 to 2006 116 |
| | XJ 1984+ 117 |
| Gladiator | JT 2019+ 119 |
| Grand Cherokee | WK2 (4x4) 2011+ 121 |
| | WJ / WG 1999 to 6/2005 122 |
| | ZJ / ZG 1993 to 1998 123 |
| JEEP - Continued | |
| Wrangler | JL 2018+ 125 |
| | JK 2006+ 127 |
| | TJ 1996 to 2/2007 128 |
| JMC | |
| Vigus | 2014+ 129 |
| KIA | |
| Sorento | BL 2003 to 2008 130 |
| LADA | |
| Niva | 1978+ 131 |
| LAND ROVER | |
| Defender | 110 Series County / Dual Cab 134 |
| | 130 Series County / Dual Cab 134 |
| | 110 Series Trayback 135 |
| | 90 Series 136 |
| Discovery | Series 3 LR3 (Coil Springs) 2004 to 2009 139 |
| | Series 2 (Coil Springs) 1999 to 2005 140 |
| | Series 1 1989 to 2005 141 |
| Range Rover | (Coil Springs) 1971 to 1995 137 |
| LDV | |
| T60 | 2.8L Turbo Diesel 2017+ 142 |
| MAHINDRA | |
| Scorpio | Getaway Pik-Up 2002 to 2016 144 |
| | Wagon 2002 to 2014 145 |
| MAZDA | |
| BT50 | 6/2020+ 148 |
| | 2011 to 5/2020 152 |
| | 2006 to 2011 155 |
| B Series Bravo | 1987 to 2006 158 |
| MERCEDES BENZ | |
| G-Wagen | W460, W461 W463 1979+ 158 |
| | G55 AMG 159 |
| Unimog | UL1700, 2450, U5000, 1300, 1550, U4000 160 |
| X-Class | 4 Cyl Models 2017 to 5/2020 161 |
| MITSUBISHI | |
| Challenger Montero Sport | PA (Coil) 1998 to 2008 175 |
| | PA (Leaf) 1998 to 2006 176 |
| Delica | L400 1994+ 177 |
| Pajero | Montero NM - NX 2000+ 168 |
| | iO Pinin 1999+ 169 |
| | Montero NH - NL (Coil) 6/1991 to 2000 170 |
| | Montero NH - NL (Leaf) 1991 to 1999 171 |
| | Montero NA - NG (Coil) 1988 to 1991 172 |
| | Montero NA - NG (Leaf) Pre 1991 173 |
| Pajero Sport | 7/2019+ 163 |
| | 2.4L Mivec 2015 to 6/2019 165 |
| Pajero Sport / Montero Sport / Dakar | PB 2009 to 2015 174 |
| Triton | MR 11/2018+ 180 |
| | MQ L200 2015 to 10/2018 184 |
| | MN L200 2009 to 2015 188 |
| | ML L200 2006 to 2009 191 |
| | MK L200 1996 to 2006 193 |
| | ME-MJ 1993 to 1996 194 |
| | L200 Pre 1983 195 |



Contents - Suspension to Suit

NISSAN

| | | |
|-----------------|---|-----|
| Navara | NP300 (Coil Springs) 2021+ Series 5..... | 198 |
| | NP300 (Leaf Springs) 2021+ Series 5..... | 199 |
| | NP300 (Coil Springs) 2015 to 2020 Series 1 to 4 | 198 |
| | NP300 (Leaf Springs) 2014 to 2020 Series 1 to 4 | 198 |
| | D40 (V6 Diesel) 2005+ | 204 |
| | D40 (4cyl Diesel and V6 Petrol) 2005+..... | 205 |
| | D22 / NP300 (Torsion Bar) 1997+..... | 207 |
| | D21 1985 to 1996 | 208 |
| Paladin | Pre 2005 | 209 |
| Pathfinder | R51 (V6 Diesel) 7/2005+ | 211 |
| | R51 (4cyl Diesel and V6 Petrol) 7/2005+..... | 213 |
| | R50 1995 to 7/2005 | 214 |
| | R20 Pre 1995 | 215 |
| Patrol | Y62 2010+ | 217 |
| | Y61 GU LWB Wagon..... | 220 |
| | Y60 GQ Cab Chassis (Coil / Coil) | 224 |
| | Y61 GU Cab Chassis (Coil / Coil)..... | 224 |
| | Y60 GQ Cab Chassis (Coil / Leaf) | 227 |
| | Y61 GU Cab Chassis (Coil / Leaf)..... | 227 |
| | Y60 GQ Cab Chassis (Leaf / Leaf) 1988+ | 229 |
| | Y60 GQ LWB Wagon 1988 to 1998 | 230 |
| | Y60 GQ SWB Wagon 1988 to 1998 | 232 |
| | MK G160 (Rectangle Headlights) 1984+ | 234 |
| | MQ G160 (Round Headlights) Pre 1984..... | 235 |
| Terrano/II WD21 | Pre 1995 | 215 |
| Xterra | 2005+..... | 236 |
| Xtrail | T30 2001 to 9/2007 | 237 |

RAM

| | | |
|------|------------------|-----|
| 1500 | DT 6/2018+ | 238 |
| | DS 2014+ | 240 |

RENAULT

| | | |
|---------|---|-----|
| Alaskan | 2017+ (See Nissan Navara NP300 Page 198)..... | 198 |
| Duster | 2010+..... | 242 |

SSANGYONG

| | | |
|---------|--------------------------------|-----|
| Korando | 1996 to 2006 | 247 |
| Musso | Q200 SWB 10/2018+ | 244 |
| | Q201 LWB (Coil) 10/2018+ | 245 |
| | Q215 LWB (Coil) 10/2018+ | 245 |
| | Q201 LWB (Leaf) 10/2018+ | 246 |
| | Q205 LWB (Leaf) 10/2018+ | 246 |
| | Q215 LWB (Leaf) 10/2018+ | 246 |
| | 1996 to 2006 | 247 |
| Rexton | Y400 2018+ | 249 |
| | Y450 2018+ | 249 |

SUBARU

| | | |
|----------|------------------------------------|-----|
| Forester | 2019+ | 250 |
| | SF5, GX, RX, GT 1997 to 2013 | 251 |
| Outback | 2015+..... | 252 |
| XV | 2018+..... | 253 |

SUZUKI

| | | |
|--------------|-----------------------------------|-----|
| Grand Vitara | 8/2005 to 2015 | 261 |
| | 1988 to 7/2005 | 262 |
| Jimny | GJ 2018+ | 255 |
| | SN413 1998 to 2018 | 257 |
| Sierra | SJ80 (Coil) 1997+ | 258 |
| | Samurai LJ, SJ (Leaf) 1981+ | 259 |
| Vitara | 1988+..... | 263 |

TOYOTA

| | | |
|-------------------|---|-----|
| 4Runner | Gen 4 and 5, N210 - N280 2003+ | 265 |
| | Gen 3 N180 - N185 1996 to 2002 | 266 |
| | Gen 2 Surf N130 V6 (Coil) 1990 to 1997 | 267 |
| | Gen 1 N60 (Leaf) 1988 to 1997 | 268 |
| Bundera | 1984 to 1989 | 329 |
| FJ Cruiser | 2006+..... | 271 |
| Fortuner | 2015+..... | 272 |
| | 2004 to 2015 | 275 |
| Hiace | Series 300 2019+ | 276 |
| | Series 200 2005 to 2019..... | 277 |
| Highlander | 2020+..... | 293 |
| Hilux | 8/2020+..... | 280 |
| | Revo 2015 to 7/2020..... | 284 |
| | Vigo 3/2005 to 9/2015 | 287 |
| | Low Ride 2WD 2005+ | 289 |
| | Tiger 107, 108, 110, 111 167 1997 to 2005 | 290 |
| | Solid Front Axle 11/1983 to 11/1997 | 291 |
| | Solid Front Axle 1979 to 10/1983 | 292 |
| Kluger | 2020+..... | 293 |
| Landcruiser | 300 Series 2020+ | 295 |
| | 200 Series (Facelift) 11/2015+ | 297 |
| | 200 Series 11/2007 to 10/2015+ | 299 |
| | 105 Series 1998+ | 301 |
| | 100 Series, IFS 1998+..... | 304 |
| | 80 Series 1990+ | 306 |
| | 79 Series Single Cab 1999+ | 309 |
| | 79 Series Dual Cab 2013+ | 312 |
| | 78 Series 2007+ | 316 |
| | 78 Series 1999 to 2007 | 320 |
| | 76 Series 2007+ | 324 |
| | 75 Series 1984 to 1999..... | 327 |
| | 71 Series (Coil / Leaf) 1999+..... | 330 |
| | 70, 73, 74 Series (Leaf / Leaf) 1984 to 1988..... | 331 |
| | 60 Series 1986+ | 332 |
| | 60 Series Pre 1986..... | 334 |
| | 45, 47 Series 8/1980 to 1985..... | 336 |
| | 45 Series 1960 to 1980..... | 337 |
| | 40, 42, 46 Series 1980 to 1984 | 338 |
| | 40 Series 1960 to 1980..... | 339 |
| Prado | 150 Series (Coil) 12/2017+ | 341 |
| | 150 Series (Coil) 2009 to 11/2017 | 344 |
| | 120 Series 4/2003 to 10/2009 | 346 |
| | 90, 95 Series 1996 to 10/2002..... | 349 |
| | II Prado 70, 73, 78 Series 1990 to 1996..... | 328 |
| Rav4 | 2019 to 2021 | 269 |
| Tacoma | 2005+..... | 351 |
| Tundra | 2006 to 2021 | 353 |
| TROLLER | | |
| T4 | 7/2014+..... | 354 |
| | 1997 to 6/2014 | 355 |
| UAZ | | |
| Hunter | All Models | 356 |
| Patriot | 1997+..... | 357 |
| VOLKSWAGEN | | |
| Amarok | V6 / 4 Cyl 11/2016+ | 359 |
| | 1997 to 10/2016 | 361 |

Contents - Suspension to Suit

SPARE PARTS

| | |
|------------------|-----|
| Suspension | 370 |
|------------------|-----|

ACCESSORY INSTALLATION FITTING TIMES

| | |
|---|-----|
| Approximate Accessory Fitting Times | 373 |
|---|-----|

GVM UPGRADES TO SUIT (BY VEHICLE)

| | | |
|-------------|---|-----|
| Ranger | PX Mk III (not USA model) 7/2018+ | 378 |
| | PX Mk II (not USA model) 2015 to 6/2018 | 379 |
| | T6 PX (not USA model) 2011 to 2015 | 379 |
| Colorado | RG 2016 to 2020 | 380 |
| | RG 2012 to 2016 | 380 |
| D-Max | MY20+ | 381 |
| | 6/2012 to 7/2019 | 382 |
| BT50 | 6/2020+ | 383 |
| Jimny | GJ 2018+ | 384 |
| Hilux | 8/2020+ | 385 |
| | Revo 2015 to 4/2018 | 385 |
| | Vigo 3/2005 to 2015 | 386 |
| Landcruiser | 200 Series MC NA 2007+ | 387 |
| | 79 Series Single Cab 2007+ | 388 |
| | 79 Series Dual Cab 2012+ | 389 |
| | 78 Series Troop Carrier 2007+ | 390 |

SUSPENSION PART SELECTION

| | |
|--|-----|
| Understanding Load | 392 |
| Determining Load | 393 |
| Understanding Terrain | 394 |
| Understanding Valving | 395 |
| Understanding GVM Upgrades | 396 |
| Suspension Kit Selection | 397 |
| Shock Absorber Application Guide | 398 |
| Features and Benefits | 402 |
| Load Plus Helper Springs Application Guide | 406 |

SUSPENSION TECHNICAL SPECIFICATIONS

| | |
|--|-----|
| Installation Times | 410 |
| Installation Form | 411 |
| Coil Springs Technical Specifications | 412 |
| Leaf Springs Technical Specifications | 415 |
| Torsion and Sway Bars Technical Specifications | 417 |
| Shock Absorbers - Nitro Gas Technical Specifications | 418 |
| Shock Absorbers - Foam Cell Technical Specifications | 420 |
| Shock Absorbers - Foam Cell Pro Technical Specifications | 421 |
| Steering Dampers Technical Specifications | 424 |
| Shock Absorber Mount Types Technical Specifications | 425 |
| Trim Packers Technical Specifications | 426 |
| U-Bolts Technical Specifications | 427 |
| Load Plus Helper Springs Technical Specifications | 427 |
| Suspension Rubber Arm Bush Kits Technical Specifications | 428 |
| Strut Compressor | 429 |
| FAQ / Troubleshooting | 430 |

QUICK REFERENCE INDEX

| | |
|------------------------------|-----|
| Product Code Reference | 461 |
|------------------------------|-----|

TERMS AND CONDITIONS

| | |
|-------------------------------------|-----|
| Terms and Conditions of Trade | 482 |
|-------------------------------------|-----|

4WD and Touring Gear

CATALOGUE AND PRICE LIST

Effective 1 December 2022

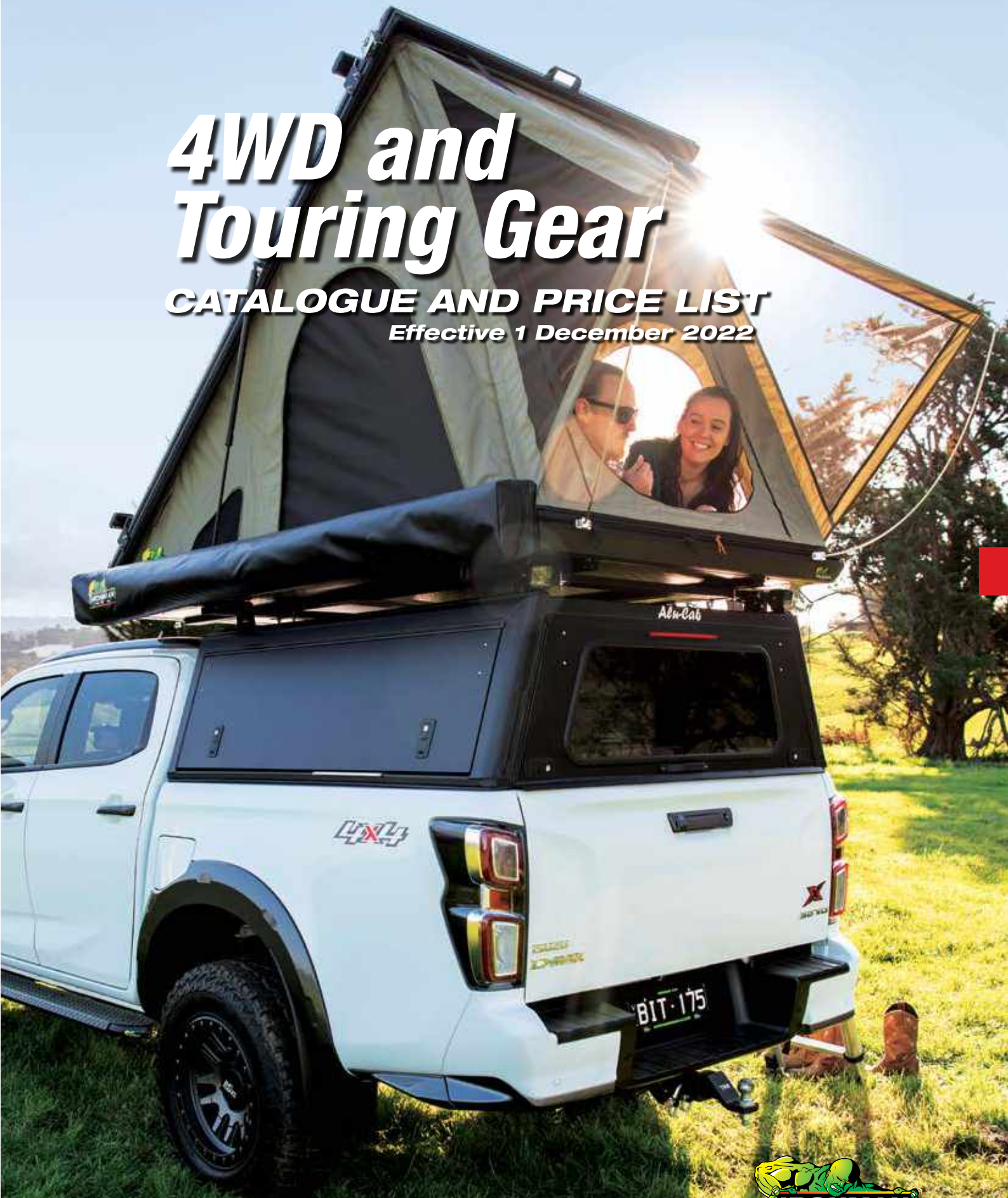

Recovery

Product Description

Part No.

Retail
ea Inc GST

ELECTRIC WINCHES

| | | |
|---|-------------------|-----------|
| A Monster Winch 9500lb - 12V (With Steel Cable) - <i>See below for Extension Plugs</i> | WWB9500 | \$885.00 |
| B Monster Winch 12000lb - 12V (With Steel Cable) - <i>See below for Extension Plugs</i> | WWB12000 | \$997.00 |
| C Monster Winch 9500lb - 12V (With Synthetic Rope) - <i>See below for Extension Plugs</i> | WWB9500SR | \$1112.00 |
| D Monster Winch 12000lb - 12V (With synthetic rope) - <i>See below for Extension Plugs</i> | WWB12000SR | \$1223.00 |

WINCH ACCESSORIES

| | | |
|---|----------------------|----------|
| E Winch Control Extension Plug - 500mm Length | WWB030 | \$27.00 |
| E Winch Control Extension Plug - 1000mm Length | WWB031 | \$32.00 |
| E Winch Control Extension Plug - 1500mm Length | WWB032 | \$37.00 |
| F Synthetic Winch Rope - 9.5mm x 27m (8100kg) | WWWROPE001 | \$514.00 |
| G Winch Damper Blanket | WINCH BLANKET | \$41.00 |
| H Alloy Hawse Fairlead | WWWHAWSE | \$89.00 |

RECOVERY KITS

| | | |
|--|-------------------|----------|
| I Small Recovery Kit - <i>While Stocks Last</i> | IRECKIT004 | \$181.00 |
| J Large Recovery Kit - <i>While Stocks Last</i> | IRECKIT003 | \$376.00 |

**TECHNICAL DIMENSIONS AND SPECIFICATIONS
SEE PAGE 440**



Recovery

Product Description

Part No.

Retail
ea Inc GST

RECOVERY STRAPS AND ACCESSORIES

| | | |
|--|-----------------------|----------|
| K Universal Recovery Hook - 4500kg Rating - <i>While Stocks Last</i> | ITOW | \$26.00 |
| L Recovery Hitch - 4.75t Rating (With bow shackle) - <i>While Stocks Last</i> | IHOOK BOW | \$67.00 |
| M Bow Shackle - 4.75t Rating | IBOW | \$18.00 |
| N Snatch Block - 8000kg Rating | IBLOCK | \$67.00 |
| O Heavy Duty Drag Chain (5m x 8mm) - <i>While Stocks Last</i> | IDRAG | \$101.00 |
| P Leather Recovery Gloves - <i>While Stocks Last</i> | IGLOVES | \$15.00 |
| Q Soft Shackle - 14000kg (500mm x 12mm) - <i>While Stocks Last</i> | ISOFSHA001 | \$52.00 |
| R Soft Shackle- 17500kg (500mm x 12mm) - <i>While Stocks Last</i> | ISOFSHA002 | \$63.00 |
| S Recovery Rope - 9500kg (9m x 22mm) | ISNATCHROPE | \$188.00 |
| T Snatch Strap - 8000kg (9m x 75mm) | ISNATCH005 | \$90.00 |
| U Snatch Strap - 11000kg (9m x 100mm) - <i>While Stocks Last</i> | ISNATCH006 | \$120.00 |
| V Tree Trunk Protector - 12000kg (3m x 75mm) | ITREE | \$55.00 |
| W Winch Extension Strap - 4500kg (20m x 50mm) - <i>While Stocks Last</i> | IWINCHEXT | \$79.00 |
| Large Recovery / Accessory Bag - <i>While Stocks Last</i> | IRECKIT001 BAG | \$34.00 |
| Small Recovery / Accessory Bag - <i>While Stocks Last</i> | IRECKIT002 BAG | \$21.00 |



Recovery

Product Description

Part No.

Retail
ea Inc GST

COMPRESSORS

| | | |
|--|-----------------------|----------|
| A Air Champ Compressor - 12V (90L/min) | ICOMPRESSOR003 | \$165.00 |
| B Air Champ Pro Compressor - 12V (160L/min) | ICOMPRESSOR004 | \$220.00 |

TYRE ACCESSORIES

| | | |
|--|---|---------------------|
| C Air Champ Dual Inflator Air Champ Extension Hose to suit Dual Inflator | ITYRE007 ITYRE008 | \$97.00 \$34.00 |
| D Air Champ Smart Deflator with Gauge - <i>While Stocks Last</i> | ITYRE005 | \$68.00 |
| E Air Champ Compact Deflator - <i>While Stocks Last</i> | ITYRE004 | \$41.00 |
| F Speedy Deflator with Gauge - <i>While Stocks Last</i> | ISPEEDY | \$83.00 |
| G Air Champ Pressure Gauge | ITYRE006 | \$41.00 |
| H AirPlugger Tyre Repair Kit (Single) AirPlugger Tyre Repair Kit (12 Pack) | ITYRE009 ITYRE009PROMO | \$24.95 \$299.40 |
| I Tyre Repair Kit | ITYRE001 | \$82.00 |
| J Tyre Repair Cord (Refill 25pc) | ITYRE002 | \$20.00 |

LIFTING JACKS

| | | |
|---|---------------------|----------|
| K Bumper Lift Kit | IHIGHLIFT003 | \$37.00 |
| L 4WD Lift Jack - 48" (Includes cover) | IHIGHLIFT001 | \$184.00 |
| M 4WD Lift Jack - 60" (Includes cover) | IHIGHLIFT002 | \$209.00 |

DIFF BREATHER KIT

| | | |
|----------------------------|-----------------|----------|
| N Diff Breather Kit | IDIFFBRE | \$115.00 |
|----------------------------|-----------------|----------|



Recovery

Product Description

Part No.

Retail
ea Inc GST

RECOVERY BOARDS

| | | |
|---|-----------------------|----------|
| O Reco-Traks - Sand (Pair) | IRECBRDSAND | \$229.00 |
| P Reco-Traks - Grey (Pair) | IRECBRDGREY | \$229.00 |
| Q Reco-Traks - Green (Pair) | IRECBRDGREEN | \$229.00 |
| R Recovery Board Mounting Base | IRECBRDBASE | \$23.00 |
| S Recovery Board Mount Pins 110mm (Pair) | IRECBRDPINS115 | \$28.00 |
| T Recovery Board Leash (Pair) | IRECBRDLEASH | \$21.00 |

ANCHOR TRACKS

| | | |
|--|-------------------|---------|
| U 610mm Anchor Track | ITRACK610 | \$52.00 |
| V 305mm Anchor Track | ITRACK305 | \$36.00 |
| W Additional Rings - Twin Pack (2Rings) | ITRACKRING | \$6.00 |

MULTI-PURPOSE REAR WHEEL BAG

| | | |
|-------------------------|----------------|---------|
| X Rear Wheel Bag | IRWB001 | \$91.00 |
|-------------------------|----------------|---------|

SEAT COVERS

| | | |
|---------------------------------------|--------------------|---------|
| Y Universal Slip-On Seat Cover | ISEAT COVER | \$29.00 |
|---------------------------------------|--------------------|---------|

AIRBAG COMPATIBLE CANVAS SEAT COVERS

| | | |
|---|---------------------|----------|
| Z Vehicle Specific Fitted Seat Cover - Front | See Vehicle Listing | \$420.00 |
| Vehicle Specific Fitted Seat Cover - Rear | See Vehicle Listing | \$420.00 |

HI VIS SAND FLAG

| | | |
|-------------------------------|----------------|----------|
| AA 1m, 2m or 3m Length | IHVFLAG | \$157.00 |
|-------------------------------|----------------|----------|



Camping Accessories

Product Description

Part No.

Retail
ea Inc GST

CAMP CHAIRS

| | | |
|---|------------|----------|
| A Quick Fold Event Chair | ICHAIR0012 | \$134.95 |
| B Low Back Quad Fold Camp Chair | ICHAIR0034 | \$49.95 |
| C Club Lounge Quad Fold Camp Chair | ICHAIR0045 | \$114.95 |
| D King Hard Arm Camp Chair - With Lumbar Support | ICHAIR0067 | \$119.95 |
| E King Quad Camp Chair - With Lumbar Support | ICHAIR0056 | \$119.95 |

PET COMFORT

| | | |
|--|----------|---------|
| F Quick Fold Dog Bed with Padded Mat (80x 80x 25cm) | IPET0023 | \$94.95 |
|--|----------|---------|



Camping Accessories

Product Description

Part No.

Retail
ea Inc GST

CAMP TABLES / STEPS

| | | |
|---|------------|----------|
| G Aluminium Camp Table - Adjustable Height | ITABLE0023 | \$142.00 |
| H Multi-Use Side Camp Table | ITABLE0012 | \$54.95 |
| I Quick-Fold Camping Steps (180kg rated) | IQFSTEP | \$64.00 |

CAMP SLEEPING

| | | |
|---|----------|----------|
| J Quick-Fold Camp Stretcher (150kg rated) - <i>While Stocks Last</i> | IQFS001 | \$161.00 |
| K -5° Swag Bag Sleeping Bag | ISWAGBAG | \$177.00 |

CAMP SWAGS

| | | |
|---|-----------|----------|
| L King Single - Ridge Pole Style | ISWAG0023 | \$439.00 |
| M Double - Ridge Pole Style | ISWAG0034 | \$479.00 |



SWAGS TECHNICAL DIMENSIONS SEE PAGE 459



Camping Accessories

Product Description

Part No.

Retail
ea Inc GST

CAMP GEAR

| | | |
|--|--------------------|----------|
| A Foldable Bush Toilet (200kg rated) | IBUSHTOILET | \$121.00 |
| B Bush Toilet Replacement Biodegradable Bags (10 per pack) | IBTBAGS | \$16.00 |
| C 12L Ezy-Go Flushing Toilet | ITOILET12 | \$169.00 |
| D Ezy-Go Flush Aid Part A & B (Sold together as 2 part kit) | ITOILETA+B | \$27.00 |
| E 12L Pressure Shower | ISHOWER004 | \$106.00 |
| F 15L Gravity Solar Shower | ISHOWER003 | \$35.00 |
| G Rechargeable Portable Shower - Lithium | ISHOWER001 | \$84.00 |



Camping Accessories

Product Description

Part No.

Retail
ea Inc GST

CAMP TOOLS

| | | | |
|----------|---|------------|----------|
| H | 3 Piece Shovel (Incl. Carry Bag) <i>(opposite page)</i> | ISHOVEL001 | \$170.00 |
| I | Tent Peg Mallet <i>(opposite page)</i> | IMALLET | \$22.00 |
| J | 0.7Kg (1.5lb) Axe <i>(opposite page)</i> | IAXE002 | \$26.00 |
| K | 2.0Kg (4.4lb) Axe Splitter <i>(opposite page)</i> | IAXE001 | \$82.00 |

CAMP KITCHEN

| | | | |
|----------|---|----------------|----------|
| L | Portable Fire Pit System | IFIREPIT0012 | \$282.00 |
| M | Rotisserie Kit to Suit Fire Pit System | IFIREPIT0023 | \$188.00 |
| N | 12V Portable Oven with Racks and Tray | IOVEN0012 | \$299.00 |
| O | Collapsible Bin with Lid - 8L | IBIN0012 | \$21.00 |
| P | Collapsible Bucket with Handle - 10L | IBUCKET0012 | \$21.00 |
| Q | Collapsible Washing Tub - 8.5L | ITUB0012 | \$21.00 |
| R | Collapsible Dish Rack with Tray - 8.5L | IDISH0012 | \$21.00 |
| S | Collapsible Storage Tub with Lid - 45L | ISTORE0023 | \$58.00 |
| T | Collapsible Storage Tub with Lid - 30L | ISTORE0012 | \$49.00 |
| U | Collapsible Silicone Kettle - Food Grade (1.5L) | IKETTLE001 | \$67.00 |
| V | Thermal Travel Tumbler 355ml / 12oz | IDRINKWARE0012 | \$27.00 |
| W | Thermal Travel Tumbler 590ml / 20oz | IDRINKWARE0023 | \$32.00 |
| X | Thermal Travel Tumbler 940ml / 32oz | IDRINKWARE0034 | \$37.00 |

CLEANING

| | | | |
|----------|--|-------------|---------|
| Y | 500ml Gritty Hand Wash (RRP only) | IHCLEAN | \$15.00 |
| | 500ml Gritty Hand Wash (Box of 6 only) | IHCLEAN BOX | \$76.00 |



NEW



Camp Lighting

Product Description

Part No.

Retail
ea Inc GST

LIGHTING

| | | |
|---|----------------|----------|
| A LED Area Light | IAREALED001 | \$125.00 |
| B LED Area Light Tripod Stand | IAREATRIPOD | \$31.00 |
| C Mini LED Lantern - <i>While Stocks Last</i> | ILANTERN002 | \$46.00 |
| D LED Worklight Combo - <i>While Stocks Last</i> | ILEDWLC | \$76.00 |
| E Rechargeable LED Lantern and Bug Zapper | ILANTERN004 | \$52.00 |
| F Rechargeable Hi-Flow Tent Fan and LED Light | ITENTFAN003 | \$62.00 |
| G LED Tent Light / Fan | ITENTFAN002 | \$41.00 |
| H LED Tent Light | ITENTLIGHT002 | \$18.00 |
| I LED Sensor Headlamp | IHEADLAMP002 | \$40.00 |
| J Awning 12V LED Sail Track Light Strip and Dimmer Set | IAWNINGPART006 | \$61.00 |
| K LED Light Strip (Includes switch) | ILEDSTRIP | \$59.00 |
| L LED Dimmer | ILEDDIMMER | \$21.00 |



Camp Lighting / Power

Product Description

Part No.

Retail
ea Inc GST

CAMPING POWER

| | | | |
|----------|--|---------------------|-----------|
| M | 120W Solar Panel Kit | ISOLAR120 | \$649.00 |
| N | 200W Solar Panel Kit | ISOLAR200 | \$850.00 |
| O | Portable Battery Box with DC Outlets | IBATTBOX0012 | \$105.00 |
| P | Titan 500Power Station 51Ah (220-240Vac) - Aust Only | IPOWER0012 | \$1044.00 |
| Q | Titan 500Power Station 51Ah (100-120Vac) - USA Only | IPOWER0023 | - |
| R | Titan 500Power Station 51Ah (220-240Vac) - International Only* | IPOWER0034 | - |

*Includes AC Plug Adaptor



Fridge / Freezers

Product Description

Part No.

Retail
ea Inc GST

FRIDGE / FREEZERS

| | | | |
|----------|---|---------------|-----------|
| A | 30L Fridge / Freezer - <i>While Stocks Last</i> | IFRIDGE30 | \$765.00 |
| B | 40L Fridge / Freezer - <i>While Stocks Last</i> | IFRIDGE40 | \$841.00 |
| C | 50L Fridge / Freezer - <i>While Stocks Last</i> | IFRIDGE50 | \$926.00 |
| D | 43L M-Series Metal Fridge / Freezer - Single Zone | IFRIDGE43LM | \$879.00 |
| E | 65L M-Series Metal Fridge / Freezer - Dual Zone | IFRIDGE65LDZM | \$1179.00 |
| F | 70L M-Series Metal Fridge / Freezer - Single Zone | IFRIDGE70LM | \$1099.00 |

TECHNICAL DIMENSIONS, SPECIFICATIONS AND FRIDGE TROUBLESHOOTING - SEE PAGE 452



NEW

New Features Include

- Smart phone app
- SECOP compressor
- In-built AC/DC power
- Digital display
- Protective cover



D

NEW



E



F



Fridge / Freezer Accessories

Product Description

Part No.

Retail
ea Inc GST

FRIDGE / FREEZER SLIDES

| | | |
|--|------------------------|----------|
| G Fridge Slide - 30L, 40L, 50L (Inc. 4 x straps) - <i>While Stocks Last</i> | IFRIDGESLIDE001 | \$270.00 |
| H Fridge Slide - 65L, 74L (Inc. 4 x straps) - <i>While Stocks Last</i> | IFRIDGESLIDE002 | \$373.00 |
| I Fridge Slide - 65L, 70L (Inc. 4 x straps) | IFRIDGESLIDE023 | \$359.00 |
| J Fridge Slide - 30 to 50L - Tilt (Inc. 4 x straps) | IFRIDGESLIDE034 | \$359.00 |
| K Fridge Slide - 65 to 70L - Tilt (Inc. 4 x straps) | IFRIDGESLIDE045 | \$459.00 |

FRIDGE / FREEZER ACCESSORIES (BAGS SOLD SEPARATELY)

| | | |
|--|-----------------------|----------|
| L 30L Fridge Bag - <i>While Stocks Last</i> | IFRIDGE30 BAG | \$109.00 |
| M 40L Fridge Bag - <i>While Stocks Last</i> | IFRIDGE40 BAG | \$109.00 |
| N 50L Fridge Bag - <i>While Stocks Last</i> | IFRIDGE50 BAG | \$113.00 |
| O Fridge Straps | IFRIDGE STRAPS | \$33.00 |
| P Wireless LCD Fridge Thermometer | IWFT001 | \$33.00 |

**FRIDGE SLIDE TECHNICAL DIMENSIONS
SEE PAGE 453**



Camping

Product Description

Part No.

Retail
ea Inc GST

ROOFTOP TENTS

| | | |
|--|-----------------------|------------|
| A Soft Rooftop Tent | IROOFTENT TENT | \$1485.00 |
| B Swift 1400 Rooftop Tent - Aluminium Hardtop | IRTT0012 | \$3,499.00 |
| C Nomad 1300 Rooftop Tent - ABS Hardtop | IRTT0023 | \$3,499.00 |

ROOFTOP TENT AWNINGS AND ANNEX

| | | |
|--|------------------------|----------|
| D Soft Rooftop Tent - Annex | IROOFTENT ANNEX | \$374.00 |
| Nomad 1300 Rooftop Tent - Front Extension Awning Kit | IRTTAWN0023 | \$298.00 |

ACCESSORIES

| | | |
|--|---------------------|---------|
| E Rooftop Tent - Sail Track Hanging Bag | ITENTBAG001 | \$42.00 |
| F Soft Rooftop Tent - Annex Extension Kit (Room 200mm)* | IROOFTENT003 | \$81.00 |
| G Soft Rooftop Tent Ladder Extension Kit (500mm)* | IROOFTENT002 | \$74.00 |

* Required for tent bases sitting above 1.8m from ground.

ROOFTOP TENTS DIMENSIONS - SEE PAGE 456



Camping

Product Description

Part No.

Retail
ea Inc GST



Camping

Product Description

Part No.

Retail
ea Inc GST

DELTAWING AWNINGS AND ACCESSORIES

| | | |
|--|--------------------|-----------|
| A DeltaWing XT-71 Awning (LHS) Supported - 2.0m (L) | IAWN270L034 | \$574.00 |
| DeltaWing XT-71 Awning (RHS) Supported - 2.0m (L) | IAWN270R034 | \$574.00 |
| B DeltaWing XTR-71 Awning (LHS) Unsupported - 2.0m (L) | IAWN270L023 | \$940.00 |
| DeltaWing XTR-71 Awning (RHS) Unsupported - 2.0m (L) | IAWN270R023 | \$940.00 |
| C DeltaWing XTR-143 Awning (LHS) Unsupported - 2.0m (L) * | IAWN270L012 | \$1044.00 |
| DeltaWing XTR-143 Awning (RHS) Unsupported - 2.0m (L) * | IAWN270R012 | \$1044.00 |

* Includes additional Awning Wall as a standard

• All include inclement weather stabilisation poles and guy ropes

**DELTAWING 270° AWNINGS
DIMENSIONS - SEE PAGE 455**

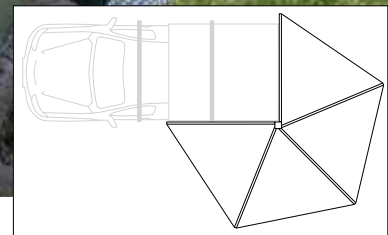
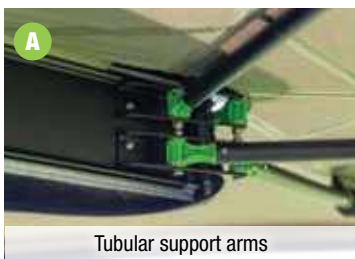

†C-Channel Triple LED Light Kit Sold Separately (IAWNLED270012)

Camping

Product Description

Part No.

Retail
ea Inc GST

DELTAWING AWNING ACCESSORIES

| | | |
|--|----------------------|----------|
| D DeltaWing XTR-143 Awning Wall Kit (LHS) - 3 Piece (suits IAWN270L012) | IAWNWALL27012 | \$470.00 |
| DeltaWing XTR-143 Awning Wall Kit (RHS) - 3 Piece (suits IAWN270R012) | IAWNWALL27045 | \$470.00 |
| E DeltaWing XT-71 and XTR-71 Awning Wall Kit - 2 Piece Door and Wall | IAWNWALL27023 | \$313.00 |
| F DeltaWing XT-71 and XTR-71 Awning Wall Kit - 2 Piece Wall Only | IAWNWALL27034 | \$313.00 |
| G Awning Camp Organiser | IAWNORG012 | \$73.00 |
| H DeltaWing XTR-143 and XTR-71 Awning LED Light Kit | IAWNLED270012 | \$104.00 |



Camping

Product Description

Part No.

Retail
ea Inc GST

INSTANT AWNINGS AND ACCESSORIES

| | | |
|--|------------------------|----------|
| A Instant Awning 1.4m (L) x 2.0m (Out) (Inc. Brackets and LED Strip) | IAWNING1.4M | \$273.00 |
| Instant Awning 2m (L) x 2.5m (Out) (Inc. Brackets and LED Strip) | IAWNING2M | \$301.00 |
| Instant Awning 2.5m (L) x 2.5m (Out) (Inc. Brackets and LED Strip) | IAWNING2.5M | \$329.00 |
| B Awning Xtra Weathershield (Suits 2m Wide Awning) - 2m A x 2.4m B x 1.4m C | IAWNING2MWALL | \$168.00 |
| Awning Xtra Weathershield (Suits 2.5m Wide Awning) - 2m A x 2.4m B x 1.4m C | IAWNING2.5MWALL | \$196.00 |
| C Awning Quick Release Bracket Kit | IAWNINGQQR | \$152.00 |
| Awning Quick Release Extra Hooks Kit | IAWNINGQQR HOOK | \$74.00 |
| AWNING ROOMS, ENCLOSURES AND ACCESSORIES | | |
| D Awning Room with Fly Screen Netting (Suits 2m Awning IAWNING2M) | IAWNING2MROOM | \$317.00 |
| Awning Room with Fly Screen Netting (Suits 2.5m Awning IAWNING2.5M) | IAWNING2.5MROOM | \$351.00 |
| E Instant Ensuite 1m x 1m | IENSUITE | \$322.00 |
| Awning Pole Kit (2x Poles, Ropes and Pegs to suit Awning Rooms) | IAWNINGPART009 | \$38.00 |

**AWNINGS AND ACCESSORIES DIMENSIONS
SEE PAGE 458**



LED Driving Lights

Product Description

Part No.

Retail
ea Inc GST

| LED DRIVING LIGHTS | | |
|--------------------|--|----------------------|
| F | 150W Scope 9" Combo LED - Driving Light (Each) | IDL0901C \$379.00 |
| G | 150W Scope 9" Spot LED - Driving Light (Each) | IDL0901S \$379.00 |
| H | 100W Scope 7" Combo LED - Driving Light (Each) | IDL0701C \$329.00 |
| I | 100W Scope 7" Spot LED - Driving Light (Each) | IDL0701S \$329.00 |
| J | 102W Meteor 9" LED with Daytime Running Light - Driving Light (Each) | ILED9M \$391.00 |
| K | 48W Meteor 7" LED with Daytime Running Light - Driving Light (Each) | ILED7M \$289.00 |
| L | 48W Blast Phase II 7" Combo LED - Driving Light (Each) | ILEDBLAST2C \$262.00 |
| M | 48W Blast Phase II 7" Spot LED - Driving Light (Each) | ILEDBLAST2S \$262.00 |
| N | 30W Comet 7" LED - Driving Light (Each) - <i>While Stocks Last</i> | ILED7C \$208.00 |
| O | 42W Comet 9" LED - Driving Light (Each) - <i>While Stocks Last</i> | ILED9C \$236.00 |
| P | 99W 5x7 Eclipse LED with Side Shooters - Driving Light (Each) | ILED5X7 \$262.00 |

**TECHNICAL DIMENSIONS AND SPECIFICATIONS
SEE PAGE 448**

DRIVING LIGHTS



LED Lightbars

Product Description

Part No.

Retail
ea Inc GST

LED LIGHTBARS

| | | | |
|----------|--|-------------------|----------|
| A | 30W Bright Sabre-X Single Row Slim Lightbar 177mm (7") Straight | ILBSR005B | \$83.00 |
| B | 105W Bright Sabre-X Single Row Slim Lightbar 522mm (20") Straight | ILBSR003B | \$220.00 |
| C | 165W Bright Sabre-X Single Row Slim Lightbar 798mm (32") Straight | ILBSR002B | \$309.00 |
| D | 210W Bright Sabre-X Single Row Slim Lightbar 1005mm (40") Straight | ILBSR001B | \$403.00 |
| E | 270W Bright Sabre-X Single Row Slim Lightbar 1281mm (50") Straight | ILBSR000B | \$438.00 |
| F | 75W Bright Sabre Single Row Lightbar 524mm (20") Straight | ILBSR003BW | \$198.00 |
| G | 120W Bright Sabre Single Row Lightbar 812mm (32") Straight | ILBSR002BW | \$261.00 |
| H | 150W Bright Sabre Single Row Lightbar 1004mm (40") Straight | ILBSR001BW | \$355.00 |
| I | 200W Bright Sabre Dual Row Lightbar 561mm (21.5") Straight | ILBDR003B | \$365.00 |
| J | 300W Bright Sabre Dual Row Lightbar 815mm (32") Straight | ILBDR002B | \$417.00 |
| K | 400W Bright Sabre Dual Row Lightbar 1076mm (42.5") Straight | ILBDR001B | \$470.00 |
| L | 300W Bright Sabre Multi-Function Dual Row Lightbar 815mm (32") Straight | ILBDR002BM | \$470.00 |
| M | 400W Bright Sabre Multi-Function Dual Row Lightbar 1076mm (42.5") Straight | ILBDR001BM | \$626.00 |

BRIGHT SABRE-X SINGLE ROW LED SLIM LIGHTBARS

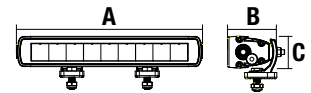

| CODE | Beam | LEDs | Watts | A | B | C |
|-----------|-------|------|-------|--------|------|------|
| ILBSR005B | Combo | 6 | 30W | 177mm | 54mm | 40mm |
| ILBSR003B | Combo | 21 | 105W | 522mm | 54mm | 40mm |
| ILBSR002B | Combo | 33 | 165W | 798mm | 54mm | 40mm |
| ILBSR001B | Combo | 42 | 210W | 1005mm | 54mm | 40mm |
| ILBSR000B | Combo | 54 | 270W | 1281mm | 54mm | 40mm |

BRIGHT SABRE SINGLE ROW LED LIGHTBARS

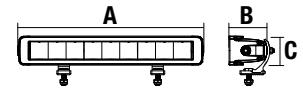

| CODE | Beam | LEDs | Watts | A | B | C |
|------------|-------|------|-------|--------|--------|------|
| ILBSR003BW | Combo | 15 | 75W | 524mm | 66.5mm | 52mm |
| ILBSR002BW | Combo | 24 | 120W | 812mm | 66.5mm | 52mm |
| ILBSR001BW | Combo | 30 | 150W | 1004mm | 66.5mm | 52mm |

BRIGHT SABRE DUAL ROW LED LIGHTBARS

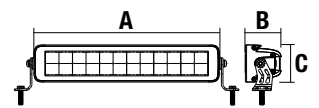

| CODE | Beam | LEDs | Watts | A | B | C |
|-----------|-------|------|-------|--------|------|------|
| ILBDR003B | Combo | 40 | 200W | 561mm | 67mm | 70mm |
| ILBDR002B | Combo | 60 | 300W | 815mm | 67mm | 70mm |
| ILBDR001B | Combo | 80 | 400W | 1076mm | 67mm | 70mm |

BRIGHT SABRE DUAL ROW MULTI-FUNCTION LED LIGHTBARS

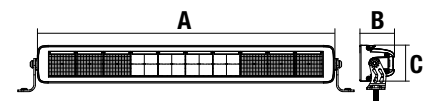

| CODE | Beam | LEDs | Watts | A | B | C |
|---|-------|------|-------|--------|------|------|
| ILBDR002BM | Combo | 60 | 300W | 815mm | 70mm | 67mm |
| <i>Interspersed Multi-Function LEDs - 45 White LEDs / 60 Amber LEDs</i> | | | | | | |
| ILBDR001BM | Combo | 80 | 400W | 1076mm | 70mm | 67mm |
| <i>Interspersed Multi-Function LEDs - 60 White LEDs / 75 Amber LEDs</i> | | | | | | |



LED Lightbars / Driving Light Accessories

Product Description

Part No.

Retail
ea Inc GST

NIGHT SABRE SINGLE ROW LED LIGHTBARS

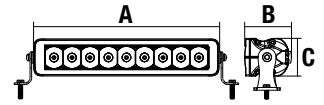

STRAIGHT BAR



N O P Q

CURVED BAR



R S T

| CODE | Beam | LEDs | Watts | A | B | C |
|---------------------|------|------|-------|-------|------|------|
| Straight Bar | | | | | | |
| ILBSR004 | Spot | 9 | 45W | 279mm | 63mm | 54mm |
| ILBSR003 | Spot | 18 | 90W | 500mm | 63mm | 54mm |
| ILBSR002 | Spot | 27 | 135W | 722mm | 63mm | 54mm |
| ILBSR001 | Spot | 36 | 180W | 942mm | 63mm | 54mm |
| Curved Bar | | | | | | |
| ILBSR003C | Spot | 18 | 90W | 500mm | 63mm | 54mm |
| ILBSR002C | Spot | 27 | 135W | 722mm | 63mm | 54mm |
| ILBSR001C | Spot | 36 | 180W | 942mm | 63mm | 54mm |

TECHNICAL DIMENSIONS AND SPECIFICATIONS SEE PAGE 450

MODULAR LIGHTBARS



U



V

LIGHTBAR ACCESSORIES



W

LED LIGHTBARS

| | | | |
|---|---|-----------|----------|
| N | 180W Night Sabre Lightbar 942mm (37") Straight - <i>While Stocks Last</i> | ILBSR001 | \$457.00 |
| O | 135W Night Sabre Lightbar 722mm (28.5") Straight - <i>While Stocks Last</i> | ILBSR002 | \$351.00 |
| P | 90W Night Sabre Lightbar 500mm (19.5") Straight - <i>While Stocks Last</i> | ILBSR003 | \$249.00 |
| Q | 45W Night Sabre Lightbar 279mm (11") Straight - <i>While Stocks Last</i> | ILBSR004 | \$189.00 |
| R | 180W Night Sabre Lightbar 942mm (37") Curved - <i>While Stocks Last</i> | ILBSR001C | \$498.00 |
| S | 135W Night Sabre Lightbar 722mm (28.5") Curved - <i>While Stocks Last</i> | ILBSR002C | \$391.00 |
| T | 90W Night Sabre Lightbar 500mm (19.5") Curved - <i>While Stocks Last</i> | ILBSR003C | \$292.00 |
| U | 30W Modular Lightbar Flood - 180mm - <i>While Stocks Last</i> | ILED180F | \$208.00 |
| V | 30W Modular Lightbar Spot - 180mm - <i>While Stocks Last</i> | ILED180S | \$208.00 |

LIGHTBAR ACCESSORIES

| | | | |
|---|---|----------|---------|
| W | Lightbar Clamp Kit to suit BBC Bull Bars - 49mm | ILBCK049 | \$73.00 |
| W | Lightbar Clamp Kit to suit BBP Bull Bars - 61mm | ILBCK061 | \$79.00 |

LED DRIVING LIGHT COVERS

| | | | |
|----|-------------------------|--------------|---------|
| X | To Fit 7" Scope - Black | IDL070COVERS | \$27.00 |
| X | To Fit 9" Scope - Black | IDL090COVERS | \$30.00 |
| Y | To Fit 7" Blast - Blue | ILCB7BLUE | \$23.00 |
| Z | To Fit 7" Blast - Black | ILCB7BLACK | \$23.00 |
| AA | To Fit 7" Blast - Amber | ILCB7AMBER | \$23.00 |
| BB | To Fit 7" Blast - Clear | ILCB7CLEAR | \$23.00 |
| Y | To Fit 7" Comet - Blue | ILC7BLUE | \$23.00 |
| Z | To Fit 7" Comet - Black | ILC7BLACK | \$23.00 |
| AA | To Fit 7" Comet - Amber | ILC7AMBER | \$23.00 |
| BB | To Fit 7" Comet - Clear | ILC7CLEAR | \$23.00 |
| Y | To Fit 9" Comet - Blue | ILC9BLUE | \$30.00 |
| Z | To Fit 9" Comet - Black | ILC9BLACK | \$30.00 |
| AA | To Fit 9" Comet - Amber | ILC9AMBER | \$30.00 |
| BB | To Fit 9" Comet - Clear | ILC9CLEAR | \$30.00 |

DRIVING LIGHT COVERS



LED Work Lights

| Product Description | DATE AVAILABLE | Part No. | Retail ea Inc GST |
|---|----------------|------------|----------------------|
| LED WORK / BAR LIGHTS | | | |
| A 30W Universal 3" with Side Shooters (Each) | | ILEDUNI3 | \$84.00 |
| B 61W Universal 5" with Side Shooters (Each) | | ILEDUNI5 | \$173.00 |
| C 18W Star Brite Rechargeable LED Floodlight (Each) | | ILEDSB | \$174.00 |
| D 20W Cosmo Dual LED Light (Each) | | ILEDCOSMO | \$173.00 |
| E 10W Spot Beam Universal LED Work Light - 93mm (Each) - Clear | | ILEDWL10 | \$52.00 |
| F 10W Flood Beam Universal LED Work Light - 93mm (Each) - Amber | | ILEDWL10FA | \$52.00 |
| G 9W Flood Beam LED Rock Light - 77 x 44mm (Each) - Clear | | IRL120B | \$32.00 |
| H 20W Bright Cube Spot Beam LED Cube Light - 70 x 64mm (Each) - Clear | | ILED20B | \$62.00 |
| 20W Bright Cube Spot Beam LED Cube Light - 70 x 64mm (Each) - Amber | | ILED20BA | \$62.00 |
| I 20W Bright Cube Flood Beam LED Cube Light - 70 x 64mm (Each) - Clear | | ILED20BF | \$62.00 |
| J 20W Bright Cube Flood Beam LED Cube Light - 70 x 64mm (Each) - Amber | | ILED20BFA | \$62.00 |
| 20W Bright Cube Flood Beam LED Cube Light - 70 x 64mm (Each) - Red | | ILED20BFR | \$62.00 |
| H 40W Bright Cube Spot Beam LED Cube Light - 81 x 75mm (Each) - Clear | | ILED80B | \$83.00 |
| 40W Bright Cube Spot Beam LED Cube Light - 81 x 75mm (Each) - Amber | | ILED80BA | \$83.00 |
| I 40W Bright Cube Flood Beam LED Cube Light - 81 x 75mm (Each) - Clear | | ILED80BF | \$83.00 |
| J 40W Bright Cube Flood Beam LED Cube Light - 81 x 75mm (Each) - Amber | | ILED80BFA | \$83.00 |
| BULL BAR LIGHT UPGRADES | | | |
| K 10W Halogen lamp LED replacement to suit Ironman 4x4 Bull Bar Light Pod (Pair) | | BBPART031 | \$114.00 |
| L Bull Bar LED Parker / Indicator / Daytime Running Light (Pair) | | BBPART002 | \$173.00 |

**TECHNICAL DIMENSIONS AND SPECIFICATIONS
SEE PAGE 449**

LED WORK LIGHTS



BULL BAR UPGRADE LIGHTS



Wire Looms / Auto Electrical / Dual Battery Systems

Product Description

Part No.

Retail
ea Inc GST

LIGHT WIRING LOOMS - SEE PAGE 451 FOR WIRING DIAGRAMS

| | | |
|---|----------|----------|
| Lightbar / Work Light Wiring Loom - Suits One (1) Light - <i>While Stocks Last</i> | IWHL001 | \$41.00 |
| Driving Light Wiring Loom - Suits Set of Two (2) Lights - <i>While Stocks Last</i> | IWHL002 | \$60.00 |
| Driving Light Wiring Loom - Suits Set of Two (2) Lights with DRL - <i>While Stocks Last</i> | IWHL003 | \$66.00 |
| Megatom Wiring Loom - Suits Set of Two (2) Megatom Lights - <i>While Stocks Last</i> | IWHL004 | \$105.00 |
| Lightbar Patch Loom | ILBWL001 | \$135.00 |
| Driving Light (7") Patch Loom | IDLWL001 | \$198.00 |
| Driving Light (9") Patch Loom | IDLWL002 | \$240.00 |

AUTO ELECTRICAL

| | | |
|--|------------|----------|
| N 40A DC to DC Battery Charger with Solar Input (Not comp. with IDCDCSA Start Assist) | IDCDCSOLAR | \$633.00 |
| O 40A DC to DC Battery Charger (80A when combined with Start Assist Kit) | IDCDC40 | \$565.00 |
| P Start Assist Booster Kit (Suits IDCDC40 Only) | IDCDCSA | \$158.00 |
| Q 12V Digital Battery Monitor (Suits single and dual battery setups) | IDBM001 | \$173.00 |
| R 140A Battery Manager (Only) | DB140 | \$121.00 |
| S 275A Battery Manager (Only) | DB270 | \$299.00 |
| Dual Battery Loom | DB LOOM | \$230.00 |
| T Universal Fit Battery Tray for Ute Tubs | IBTRAYTUB | \$250.00 |
| U Electric Brake Controller (With Remote Head) - <i>While Stocks Last</i> | IEBC001 | \$237.00 |
| V 50A Charge Wire Kit (6m x 8mm High Current Cable) | IAPKIT | \$147.00 |

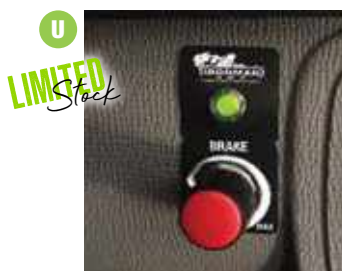

Storage - Locksafe Drawer Systems

Product Description

Part No.

Retail
ea Inc GST

A LOCKSAFE SINGLE DRAWERS

| | | |
|------------------------|----------------|----------|
| Single Drawer - 900mm | ISD900 | \$802.00 |
| Single Drawer - 1000mm | ISD1000 | \$820.00 |
| Single Drawer - 1300mm | ISD1300 | \$932.00 |

B LOCKSAFE TWIN DRAWERS

| | | |
|-----------------------|----------------|-----------|
| Twin Drawers - 900mm | ITD900 | \$1298.00 |
| Twin Drawers - 1000mm | ITD1000 | \$1355.00 |
| Twin Drawers - 1300mm | ITD1300 | \$1536.00 |

WING KITS*

| | | |
|------------------------------|-------------------------|----------|
| Left and Right Pair - 900mm | Vehicle Specific | \$283.00 |
| Left and Right Pair - 1000mm | Vehicle Specific | \$283.00 |
| Left and Right Pair - 1300mm | Vehicle Specific | \$367.00 |

FRIDGE / FREEZER SLIDES

| | | |
|---|------------------------|----------|
| Fridge Slide - 30L, 40L, 50L (Inc. 4 x straps) | IFRIDGESLIDE001 | \$270.00 |
| Fridge Slide - 65L, 74L (Inc. 4 x straps) | IFRIDGESLIDE002 | \$373.00 |
| Fridge Slide - 65L, 74L (Inc. 4 x straps) | IFRIDGESLIDE023 | \$359.00 |
| Fridge Slide - 30 to 50L - Tilt (Inc. 4 x straps) | IFRIDGESLIDE034 | \$359.00 |
| Fridge Slide - 65 to 70L - Tilt (Inc. 4 x straps) | IFRIDGESLIDE045 | \$459.00 |

**TECHNICAL DIMENSIONS AND SPECIFICATIONS SEE PAGE 454
REFER TO VEHICLE LISTING PAGES FOR SPECIFIC MODEL COMPATIBILITY / SUITABILITY**



A



G

B



***Designed to suit factory tubs, will not suit tub liner without modification**

Storage - Water Tanks

Product Description

Part No.

Retail
ea Inc GST

WATER TANKS - L X D X H

| | | |
|--|----------------|----------|
| C 20L Jerry Can with Tap - (350 x 170 x 460mm) | IWT001 | \$108.00 |
| D 40L Double Jerry Can with Barbed Outlet - (465 x 340 x 335mm) | IWT002 | \$206.00 |
| E 40L Vertical Tank with Barbed Outlet - (1100 x 75 x 700mm*) | IWT003 | \$342.00 |
| F 50L Roof Rack Tank with Barbed Outlet - (1200 x 600 x 120mm*) | IWT004 | \$342.00 |
| G 50L Wheel Arch Tank with Barbed Outlet - (1215 x 120 x 590mm*) | IWT005 | \$342.00 |
| H 50L Tapered Tank with Tap and Barbed Outlet - (1050 x 200 x 390mm*) | IWT006 | \$270.00 |
| I 60L Tank with Tap and Barbed Outlet - (845 x 360 x 270mm*) | IWT007 | \$274.00 |
| J 1.5m Plastic Water Hose Kit - Connects to barbed outlet on tanks | IWTHOSE | \$57.00 |
| K 15L Under Tray Hand Wash Tank with Tap - (345 x 255 x 305mm) | IWT008 | \$184.00 |

*Includes the height of the screw cap

WATER PUMP

| | | |
|--|----------------|----------|
| L Pressure Water Pump - 12.5L / 12VDC | IWP0023 | \$152.00 |
|--|----------------|----------|



Storage - Plastic / Metal

Product Description

Part No.

Retail
ea Inc GST

MAXI CASES - L X D X H

| | | | |
|----------|---|---------------|----------|
| A | 48L - 410 x 410 x 410mm - *Does not include removable tool tray | IMC001 | \$182.00 |
| B | 60L - 550 x 460 x 335mm (Includes tool tray) | IMC002 | \$228.00 |
| C | 65L - 900 x 460 x 250mm - *Does not include removable tool tray | IMC006 | \$282.00 |
| D | 100L - 700 x 460 x 410mm (Includes tool tray) | IMC003 | \$286.00 |
| E | 140L - 915 x 460 x 440mm (Includes tool tray) | IMC004 | \$363.00 |
| F | 216L - 1300 x 460 x 460mm (Includes tool tray) | IMC005 | \$466.00 |

STEEL TOOL BOXES - L X D X H

| | | | |
|----------|--------------------------------------|---------------|-----------|
| G | Steel Truck Box - 700 x 640 x 750mm | ITB005 | \$1038.00 |
| H | Steel Truck Box - 1210 x 640 x 750mm | ITB006 | \$1485.00 |

ALUMINIUM TOOL BOX - L X D X H

| | | | |
|----------|---|---------------|----------|
| I | Aluminium One Tonner - 900 x 500 x 680mm - <i>While Stocks Last</i> | ITB001 | \$659.00 |
|----------|---|---------------|----------|



Storage - Bags

Product Description

Part No.

Retail
ea Inc GST

CARRY AND UTILITY STORAGE BAGS - L X W X D

| | | | |
|----------|--|--------------------|----------|
| J | 200L Weatherproof Cargo Storage Bag - 1400 x 500 x 300mm - <i>While Stocks Last</i> | IRLB200 | \$202.00 |
| K | 250L Weatherproof Cargo Storage Bag - 1100 x 800 x 300mm - <i>While Stocks Last</i> | IRLB250 | \$226.00 |
| L | 350L Weatherproof Cargo Storage Bag - 1200 x 960 x 300mm - <i>While Stocks Last</i> | IRLB350 | \$262.00 |
| M | 500L Weatherproof Cargo Storage Bag - 1500 x 1100 x 300mm - <i>While Stocks Last</i> | IRLB500 | \$310.00 |
| N | 600L Weatherproof Cargo Storage Bag - 1800 x 1100 x 300mm - <i>While Stocks Last</i> | IRLB600 | \$351.00 |
| O | 65L Explorer Duffle Bag | IDUFBAG001 | \$87.00 |
| P | Rooftop Tent Hanging Bag | ITENTBAG001 | \$42.00 |



Atlas Roof Racks and Accessories

| Product Description | Part No. | Retail ea Inc GST |
|--|------------|----------------------|
| PLATFORMS - ASSEMBLED | | |
| A Platform A - 1240 x 1530mm | IFR9337 | \$949.00 |
| Platform B - 1380 x 1530mm | IFR9338 | \$949.00 |
| Platform E - 1240 x 2130mm | IFR9341 | \$1129.00 |
| Platform K - 1240 x 1390mm | IFR9347 | \$929.00 |
| Platform N - 1380 x 2130mm | IFR9373 | \$1129.00 |
| Platform S - 1485 x 1390mm | IFR9378 | \$949.00 |
| ROOF RACK BLADES | | |
| B To Suit Ford Ranger PX - Dual Cab | IFR0055 | \$589.00 |
| To Suit Ford Ranger Wildtrak - Dual Cab | IFR0055WT | \$589.00 |
| To Suit Isuzu D-Max 2020+ - Dual Cab | IFR0064 | \$589.00 |
| To Suit Mitsubishi Triton MQ and MR - Dual Cab | IFR0067 | \$589.00 |
| To Suit Nissan Navara NP300 - Dual Cab | IFR0048 | \$589.00 |
| To Suit Nissan Patrol Y62 - Full Length | IFR0062L | \$789.00 |
| To Suit Toyota Hilux Mk8 - Dual Cab | IFR0065 | \$589.00 |
| To Suit Toyota Landcruiser 200 Series - Sun Roof Model | IFR0056 | \$589.00 |
| To Suit Toyota Landcruiser 200 Series - Full Length | IFR0056L | \$789.00 |
| To Suit Toyota Prado 150 | IFR0047 | \$789.00 |
| To Suit Slide-Away Hard Tonneau Cover | IFRSLDAWAY | \$649.00 |
| LEGS | | |
| C Fixed Point and Track Leg (Mk1) - (4 Pack) | IFR0143 | \$160.00 |
| Fixed Point and Track Leg (Mk1) - (6 Pack) | IFR0144 | \$190.00 |
| Fixed Point and Track Leg (Mk2) - (4 Pack) | IFR0304 | \$210.00 |
| D Gutter Mount Leg - 110mm (2 Pack) | IFR0350 | \$120.00 |
| Gutter Mount Leg - 150mm (2 Pack) | IFR0351 | \$125.00 |
| CROSSBARS | | |
| E Crossbar 1250mm (1 Bar) | IFR0516 | \$115.00 |
| Crossbar 1375mm (1 Bar) | IFR0517 | \$120.00 |
| Crossbar 1500mm (1 Bar) | IFR0518 | \$125.00 |
| Crossbar 1650mm (1 Bar) | IFR0519 | \$130.00 |
| FIT KITS | | |
| 3 Crossbar Kit to Suit Toyota Prado 150 and Landcruiser 200 Series | IFR0311 | \$129.00 |
| Track Kit to Suit Ford Ranger and Mazda BT50 2011+ - Dual Cab | IFR0316 | \$199.00 |
| Track Kit to Suit Toyota Hilux 2015+ - Dual Cab | IFR0321 | \$199.00 |
| Track Kit to Suit Nissan Navara NP300 2015+ - Dual Cab | IFR0328 | \$199.00 |
| Track Kit to Suit Mitsubishi Triton MQ and MR 2015+ - Dual Cab | IFR0330 | \$199.00 |
| Universal Track Kit - 800mm | IFR0360 | \$129.00 |
| Universal Track Kit - 1200mm | IFR0362 | \$139.00 |
| Crossbar Flush Kit to Suit Isuzu D-Max 2020+ - Dual Cab | IFR1007 | \$261.00 |
| Canopy Permanent Mount Kit | IFR1034 | \$99.00 |

**SEE VEHICLE LISTING PAGES FOR VEHICLE SPECIFIC COMPLETE KIT OPTIONS
REFER TO VEHICLE MANUFACTURER FOR SPECIFIC ROOF LOAD CARRYING CAPACITY**

NEW



Atlas Roof Racks and Accessories

Product Description

Part No.

Retail
ea Inc GST

ACCESSORIES

| | | |
|--|---------------------|----------|
| F Shovel Holder | IFR3204 | \$58.00 |
| G Eye Bolt Kit - (2 Pack) | IFR5022 | \$31.00 |
| H Load Holder - (2 Pack) | IFR5025 | \$52.00 |
| I Awning Brackets Kit | IFR5029 | \$52.00 |
| J Recovery Tracks Holder Kit | IFR5031 | \$146.00 |
| K Platform Spare Wheel Restraint | IFR5032 | \$94.00 |
| L High Lift Jack Holder | IFR5033 | \$125.00 |
| M Platform Gas Bottle Holder | IFR5034 | \$104.00 |
| N Platform Corner Brackets Kit | IFR5036 | \$94.00 |
| O Platform Jerry Can Holder | IFR5038 | \$135.00 |
| P Platform Bottle Opener | IFRBOTT | \$20.00 |
| Q Multi-Fit Light Bracket Kit | IFRLIGHBKT | \$83.00 |
| R Ratchet Grabs - (1) | IFRRATC | \$62.00 |
| S Load Roller - (1) | IFRROLL | \$94.00 |
| T Cam Buckle Straps - 2m Length (2 Pack, Includes Soft Loops) | IRATCHET0012 | \$15.00 |
| U Ratchet Tie Down Straps - 3.6m Length (4 Pack, Includes Soft Loops) | IRATCHET0023 | \$50.00 |
| V Ratchet Tie Down Straps - 3.6m Length (2 Pack) | IRATCHET0034 | \$50.00 |

NEW

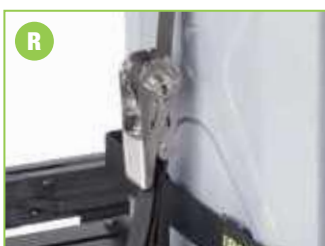
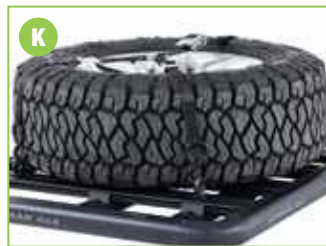

Alloy / Steel Roof Racks / Mount Accessories

Product Description

Part No.

Retail
ea Inc GST

ALLOY ROOF RACKS - POWDERCOATED METALLIC GREY, MESH FLOOR

| | | |
|--|------------------|-----------|
| A Flat Rack - 1.8m x 1.25m | IRRTFLAT18-ALLOY | \$1167.00 |
| B Cage Style - 1.4m x 1.25m | IRRCAGE14-ALLOY | \$1028.00 |
| Cage Style - 1.8m x 1.25m | IRRCAGE18-ALLOY | \$1201.00 |
| Cage Style - 2.2m x 1.25m | IRRCAGE22-ALLOY | \$1267.00 |
| C Trade Style - 1.4m x 1.25m (Open end) | IRROPEN14-ALLOY | \$1015.00 |
| Trade Style - 1.8m x 1.25m (Open end) | IRRTRADE18-ALLOY | \$1183.00 |
| Trade Style - 2.2m x 1.25m (Open end) | IRRTRADE22-ALLOY | \$1235.00 |
| Crossbar | IRRCROSSBAR001 | \$287.00 |

STEEL ROOF RACKS - POWDERCOATED BLACK, MESH FLOOR

| | | |
|---|------------|----------|
| D Cage Style - 1.4m x 1.25m | IRRCAGE14 | \$812.00 |
| Cage Style - 1.8m x 1.25m | IRRCAGE18 | \$852.00 |
| Cage Style - 2.2m x 1.25m | IRRCAGE22 | \$885.00 |
| E Rooftop Tent Compatible - 1.8m x 1.25m | IRRTENT18 | \$812.00 |
| Rooftop Tent Compatible - 2.2m x 1.25m | IRRTENT22 | \$852.00 |
| F Trade Style - 1.8m x 1.25m (Open end) | IRRTRADE18 | \$812.00 |
| Trade Style - 2.2m x 1.25m (Open end) | IRRTRADE22 | \$846.00 |



UNIVERSAL ALLOY ROOF RAIL EXTRUSION - SOLD SEPARATELY

| | | |
|---|------------|----------|
| G Alloy Extrusion - 1085mm (2 Pieces - Inc. mounting hardware) | IRREXT1085 | \$130.00 |
|---|------------|----------|

ROOF RACK MOUNTING KITS - SOLD SEPARATELY

| | | |
|---|-----------------|----------|
| Gutter Mount Feet - 100mm (8 Feet) | IRRFEET100 | \$207.00 |
| Gutter Mount Feet - 125mm (8 Feet) | IRRFEET125 | \$207.00 |
| Gutter Mount Feet - 150mm (8 Feet) | IRRFEET150 | \$207.00 |
| Gutter Mount Feet - 210mm (8 Feet) | IRRFEET210 | \$228.00 |
| Mount Feet to suit Holden Colorado 7/Trailblazer (6 Feet) - Fits fact fitted roof bars only | IRRFEET001 | \$207.00 |
| Mount Feet to suit Toyota Landcruiser 100/105 (8 Feet) | IRRFEETLC100 | \$207.00 |
| Mount Feet to suit Toyota Landcruiser 200 (8 Feet) | IRRFEETLC200 | \$207.00 |
| Mount Feet to suit Isuzu MU-X (6 Feet) - Fits factory fitted roof bars only | IRRFEETMUX | \$228.00 |
| Mount Feet to suit Toyota Prado 150 (2 Feet) | IRRFEETPRADO150 | \$228.00 |
| ABS Canopy Feet to suit 1.4m Rack | IRRFEETABS14 | \$287.00 |
| Wheel Clamp | IRRWHEEL CLAMP | \$100.00 |

**TECHNICAL DIMENSIONS AND SPECIFICATIONS SEE PAGE 446
REFER TO VEHICLE MANUFACTURER FOR SPECIFIC ROOF LOAD CARRYING CAPACITY**

Fleet and Mining Accessories

Product Description

Part No.

Retail
ea Inc GST

FLEET / MINING ACCESSORIES

| | | |
|---|---------------------------|----------|
| A High Visibility Light Bar (With lights, reverse alarm and beacon) | MINING005 | \$470.00 |
| B Fire Extinguisher (1kg) | IFIRE EXTINGUISHER | \$50.00 |
| C High Mount Flag - 1.8m (With red LED) | MINING001 | \$154.00 |
| D High Mount Flag - 2.4m (With red LED) | MINING008 | \$159.00 |
| E Hi Vis Sand Flag (1m, 2m or 3m length) | IHVFLAG | \$157.00 |
| F Reverse Camera - OE Appr. (With rear view mirror replacement) - <i>While Stocks Last</i> | IREVERSECAM001 | \$621.00 |
| G Safety Triangles (set of 3) | ISAFETYTRI | \$100.00 |
| H Universal Battery Isolator / Jump Start | IBATISO | \$342.00 |
| I Wheel Chocks - Rated to 6 tonne (set of 2) | IWC6T | \$124.00 |

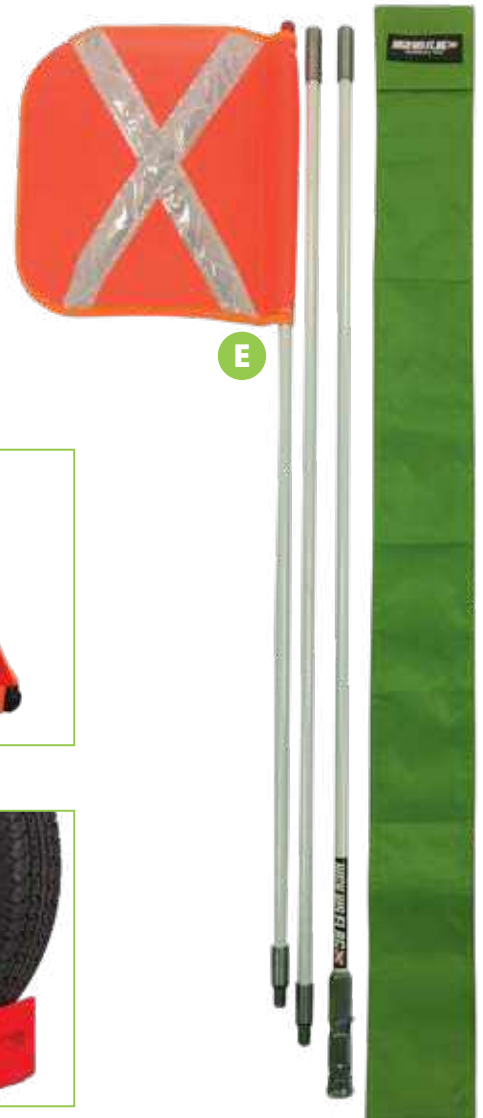

Apparel

Product Description

Part No.

Retail
ea Inc GST

IRONMAN 4X4 60TH ANNIVERSARY T-SHIRT

| | | |
|------------------------|-------------|---------|
| A Size Mens - S | IMTS001MS | \$35.00 |
| Size Mens - M | IMTS001MM | \$35.00 |
| Size Mens - L | IMTS001ML | \$35.00 |
| Size Mens - XL | IMTS001MXL | \$35.00 |
| Size Mens - 2XL | IMTS001M2XL | \$35.00 |
| Size Mens - 3XL | IMTS001M3XL | \$35.00 |
| Size Mens - 5XL | IMTS001M5XL | \$35.00 |
| Size Womens - S | IMTS001WS | \$35.00 |
| Size Womens - M | IMTS001WM | \$35.00 |
| Size Womens - L | IMTS001WL | \$35.00 |
| Size Womens - XL | IMTS001WXL | \$35.00 |

IRONMAN 4X4 FOAM CELL PRO T-SHIRT

| | | |
|------------------------|-------------|---------|
| D Size Mens - S | IMTS002MS | \$40.00 |
| Size Mens - M | IMTS002MM | \$40.00 |
| Size Mens - L | IMTS002ML | \$40.00 |
| Size Mens - XL | IMTS002MXL | \$40.00 |
| Size Mens - 2XL | IMTS002M2XL | \$40.00 |
| Size Mens - 3XL | IMTS002M3XL | \$40.00 |
| Size Mens - 5XL | IMTS002M5XL | \$40.00 |



Merchandise

Product Description

Part No.

Retail
ea Inc GST

MERCHANDISE

| | | |
|---|-----------------------|---------|
| C Black Ironman 4x4 Cap - <i>While Stocks Last</i> | CAP001 | \$14.00 |
| D Ironman 4x4 Breezy Cap - Curved Peak Black Cap | CAP002 | \$34.00 |
| E Ironman 4x4 Bank Cap - Flat Peak Grey Cap | CAP003 | \$34.00 |
| F Ironman 4x4 Key Rings | KEY001 | \$3.00 |
| G Ironman 4x4 Bottle Opener Key Rings | KEY002 | \$4.00 |
| H Ironman 4x4 Numberplate Surrounds - Slimline Fit (Pair) | INUMBPLATESLIM | \$9.00 |
| I Ironman 4x4 Metal Drink Bottle - Silver with Ironman 4x4 Logo - <i>While Stocks Last</i> | IBOTTLE001 | \$16.00 |
| J Ironman 4x4 Metal Drink Bottle - Grey with Foam Cell Pro Logo - <i>While Stocks Last</i> | IBOTTLE002 | \$16.00 |
| K Ironman 4x4 Stubby Holder | CAN001 | \$6.00 |
| L Ironman 4x4 Car Air Freshener (Adventure Fresh) *Non-retail sold as box of 150 only | IAIRFRESHBOX | \$1.10 |
| M The Australian 4WD Handbook | IBOOK001 | \$49.00 |

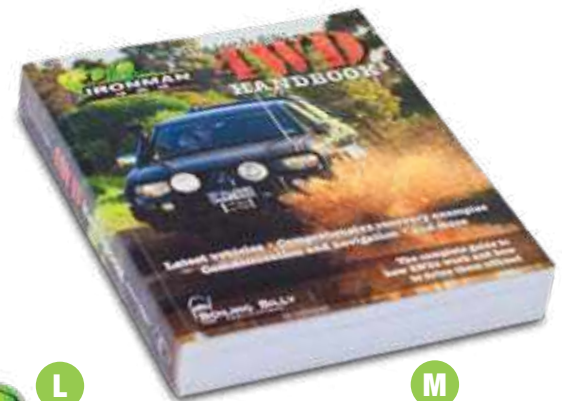



It's a RAID



Accessories and Suspension

CATALOGUE AND PRICE LIST

Effective 1 December 2022



Dacia Duster

2010+



Product Description

Part No.

Qty
Req

Retail
ea Inc GST

Please check vehicle date range (if shown) next to product description prior to ordering

SUSPENSION TO SUIT DACIA DUSTER

FRONT SUSPENSION

SHOCK ABSORBER

Nitro Gas Strut - Performance

12747GR

2

\$291.00

COIL SPRINGS

Medium

Est. Lift
40mm

Additional Load
0 - 50kg

REN001B

1

\$262.00

CAMBER CORRECTION

Camber Bolt Kit

ICAMBER12

1

\$30.00

REAR SUSPENSION

SHOCK ABSORBER

Nitro Gas Strut - Performance

12748GR

2

\$291.00

COIL SPRINGS

Medium

Est. Lift
40mm

Additional Load
0 - 200kg

REN002B

1

\$262.00

CAMBER CORRECTION

Camber Bolt Kit

ICAMBER12

1

\$30.00

SUSPENSION KIT - Specify Front Coil Springs When Ordering

Medium - Nitro Gas

REN001BKG

\$1738.00

SUSPENSION KIT CONTENTS

Shock Absorbers

Camber Bolt Kits

Coil Springs

Fiat Fullback



2016+

| Product Description | Part No. | Qty Req | Retail ea Inc GST |
|---|-------------------|------------|----------------------|
| ACCESSORIES TO SUIT FIAT FULLBACK | | | |
| STEEL WINCH BULL BARS | | | |
| Commercial | BBC050 | | \$1754.00 |
| Commercial Deluxe | BBCD050 | | \$2387.00 |
| Polished Alloy | BBA050 | | \$2472.00 |
| Proguard No Loop | BBT050-NL | | \$1973.00 |
| Proguard Single Loop Kit | BB050-SL | | \$352.00 |
| Proguard Triple Loop Kit | BB050-TL | | \$423.00 |
| STEEL SIDE STEPS AND RAILS - FITS DUAL AND CLUB CAB | | | |
| Side Steps | SS050 | | \$1006.00 |
| Side Rails | SS050 RAIL | | \$332.00 |
| Side Steps and Rails | SSR050 | | \$1207.00 |
| TOWING | | | |
| Class 4 Towbar - Compatible with Factory Rear Bumper | TB050 | | \$608.00 |
| Rear Protection Towbar - Full Rear Bumper Replacement | RTB050 | | \$1388.00 |
| Rear Protection Towbar Plates (Pair) | RTBPLATE050 | | \$153.00 |
| Towbar Wiring Loom - Plug and Play | ITBL050 | | \$276.00 |
| RECOVERY POINTS - IRONMAN 4X4 BULL BAR ONLY | | | |
| Recovery Points - 5000kg Rating (Pair) | IRP050 | | \$300.00 |
| BATTERY TRAY | | | |
| Suits 12" Battery | IBTRAY050 | | \$240.00 |
| SNORKEL - SUITS 2.4L DIESEL | | | |
| Triton MQ 2015+ | ISNORKEL050 | | \$437.00 |
| LONG RANGE FUEL TANK | | | |
| 125L* Diesel only - Fits Dual Cab only | TANK004 | | \$1180.00 |
| <i>* Usable volume may differ to the stated tank capacity</i> | | | |
| PREMIUM UNDERBODY PROTECTION | | | |
| Engine Bay and Transmission | UBP050 | | \$782.00 |
| UNDERBODY PROTECTION | | | |
| Engine Bay and Transmission - Not compatible with bull bars. - <i>While Stocks Last</i> | IUP050K | | \$563.00 |
| LOCKSAFE DRAWER SYSTEMS - FITS DUAL AND EXTRA CAB | | | |
| Twin Drawers - 1300mm | ITD1300 | | \$1536.00 |
| Single Drawer - 1300mm | ISD1300 | | \$932.00 |
| Wing Kit - 1300mm* | ITDW050 | | \$367.00 |
| <i>*Designed to suit factory tubs, will not suit ute liner without modification.</i> | | | |
| CANOPY - ABS PLASTIC (SIDE LIFT UP WINDOWS AND CENTRAL LOCKING REAR DOOR) - FITS 4X4 AND 4X2 DUAL CAB MODELS | | | |
| Pre Primed | CANOPY014-P | | \$3238.00* |
| <i>• See Page 38 for 1.4m Roof Rack options and pricing.</i> | | | |
| CANOPY - PINNACLE SMOOTH FINISH FIBREGLASS (SIDE LIFT UP WINDOWS AND CENTRAL LOCKING REAR DOOR) - FITS 4X4 AND 4X2 DUAL CAB MODELS | | | |
| Black Mica (X08) | CANFIBRE050-BM | | \$3763.00 |
| Impulse Blue (D23) | CANFIBRE050-IB | | \$3763.00 |
| Titanium Grey (U17) | CANFIBRE050-TG | | \$3763.00 |
| Sterling Silver (U25) | CANFIBRE050-SS | | \$3763.00 |
| White Solid (W32) | CANFIBRE050-WS | | \$3763.00 |
| CANOPY - PINNACLE 2 FIBREGLASS (SIDE LIFT UP WINDOWS AND CENTRAL LOCKING REAR DOOR) - FITS 4X4 AND 4X2 DUAL CAB MODELS | | | |
| Pre-Primed | ICANOPY050-P | | \$3213.00 |
| Black Mica (X08) | ICANOPY050-BM | | \$3763.00 |
| Graphite Grey (U28) | ICANOPY050-GG | | \$3763.00 |
| Impulse Blue (D23) | ICANOPY050-IB | | \$3763.00 |
| Sterling Silver (U25) | ICANOPY050-SS | | \$3763.00 |
| Titanium Grey (U17) | ICANOPY050-TG | | \$3763.00 |
| White Solid (W32) | ICANOPY050-WS | | \$3763.00 |
| <i>* Pre-primed canopies, plus colour coding.</i> | | | |
| SLIDE-AWAY ROLL UP HARD TONNEAU COVER | | | |
| Electric with Remote Control | ISLIDEAWAY067-E | | \$2716.00 |
| Sports Bar Adaptor | ISLIDEAWAY067-SBA | | \$135.00 |
| ATLAS ROOF RACK KITS | | | |
| Platform K with Leg Fit Kit to Suit Pinnacle 2 Canopy - 1390mm Length | IFRP2PKK | | \$1294.00 |
| Crossbar (x 2) and Fit Kit to Suit Pinnacle 2 Canopy - 1250mm Width | IFRP2C125K | | \$564.00 |
| Platform S with Blade Fit Kit to Suit Slideaway Hard Tonneau Cover - 1390mm Length | IFRSLDAWAYPSK | | \$1670.00 |
| Crossbar (x 2) and Fit Kit to Suit Slideaway Hard Tonneau Cover - 1500mm Width | IFRSLDAWAYC2K | | \$940.00 |
| <i>• See Page 36 and 37 for more Atlas rack and crossbar options.</i> | | | |
| BREATHER KIT | | | |
| Universal Twin Manifold Filtered Breather Kit | IDIFFBRE | | \$115.00 |

Fiat Fullback

2016+



Product Description

Part No.

Qty
Req

Retail
ea Inc GST

Please check vehicle date range (if shown) next to product description prior to ordering

SUSPENSION TO SUIT FIAT FULLBACK

FRONT SUSPENSION

SHOCK ABSORBER

| | | | | | |
|---|--|--|----------------|---|----------|
| Nitro Gas Strut - Performance | | | 12715GR | 2 | \$232.00 |
| Foam Cell Strut - Performance | | | 24715FE | 2 | \$262.00 |
| Foam Cell Pro Strut - Performance* (SEE NOTE) | | | 45715FE | 2 | \$406.00 |

**NOTE: MANDATORY FITMENT of UCA050FA and MITS045B /C Coil Springs with 45715FE*

COIL SPRINGS

| | Est. Lift | Additional Load | | | |
|--------------------|-----------|-----------------|------------------|---|----------|
| Standard | 0mm | 0 - 50kg | MIT040S | 1 | \$262.00 |
| Light | 25mm | 0 - 50kg | MIT040A | 1 | \$262.00 |
| Medium | 30mm | 0 - 80kg | MIT040B | 1 | \$262.00 |
| Medium* (SEE NOTE) | 50mm | 0 - 80kg | MIT045B * | 1 | \$262.00 |
| Heavy | 30mm | 80 - 110kg | MIT040C | 1 | \$262.00 |
| Heavy* (SEE NOTE) | 50mm | 80 - 110kg | MIT045C * | 1 | \$262.00 |

**NOTE: MANDATORY FITMENT of UCA050FA and 45715FE with (MIT045B /C) Coil Springs*

STRUT MOUNTS

| | | | | | |
|-----------------|--|--|----------------|---|----------|
| Steel Strut Top | | | ISST010 | 2 | \$102.00 |
|-----------------|--|--|----------------|---|----------|

TRIM PACKERS

| | | | | |
|------------------------|-----------------------|-------------------------|---|---------|
| 5mm Strut Trim Packer | Nitro Gas / Foam Cell | HILFR05/HILFR05F | 2 | \$30.00 |
| 10mm Strut Trim Packer | Nitro Gas / Foam Cell | HILFR10/HILFR10F | 2 | \$30.00 |
| 15mm Strut Trim Packer | Nitro Gas / Foam Cell | HILFR15/HILFR15F | 2 | \$30.00 |

• ONLY Compatible with Ironman 4x4 Struts, lift height subject to 2:1 motion ratio. Unnecessary fitment may lift vehicle too high

CONTROL ARMS

| | | | | | |
|------------------------------|--|--|-----------------|---|----------|
| Pro-Forge Upper Control Arms | | | UCA050FA | 1 | \$882.00 |
|------------------------------|--|--|-----------------|---|----------|



Fiat Fullback



2016+

| Product Description | Part No. | Qty Req | Retail ea Inc GST |
|---|----------------|-----------------|---------------------|
| <i>Please check vehicle date range (if shown) next to product description prior to ordering</i> | | | |
| REAR SUSPENSION | | | |
| SHOCK ABSORBER | | | |
| Nitro Gas - Comfort | 12729GRC | 2 | \$160.00 |
| Nitro Gas - Performance | 12729GR | 2 | \$160.00 |
| Nitro Gas - Professional | 12729GRP | 2 | \$160.00 |
| Foam Cell - Comfort | 24729FEC | 2 | \$232.00 |
| Foam Cell - Performance | 24729FE | 2 | \$232.00 |
| Foam Cell - Professional | 24729FEP | 2 | \$232.00 |
| Foam Cell Pro - Comfort | 45729FEC | 2 | \$319.00 |
| Foam Cell Pro - Performance | 45729FE | 2 | \$319.00 |
| Foam Cell Pro - Professional | 45729FEP | 2 | \$319.00 |
| LEAF SPRINGS | | | |
| | Est. Lift | Additional Load | |
| Light | 30mm | 0 - 200kg | MITS047A 2 \$392.00 |
| Medium | 30mm | 0 - 300kg | MITS047B 2 \$392.00 |
| Heavy | 30mm | 300kg - GVM | MITS047C 2 \$421.00 |
| • Two piece tailshaft models may experience driveline vibration, use 1201K to reduce vibration. | | | |
| U-BOLTS | | | |
| U-Bolt Kit | | | 437UBK 2 \$44.00 |
| U-Bolt Kit | Suits MITS047C | | 437UBKL 2 \$44.00 |
| POLYURETHANE SPRING BUSHES | | | |
| Bush Kit | | | 1200UK 1 \$88.00 |
| DRIVELINE SPACERS | | | |
| Centre Bearing Spacer Kit | | | 1201K 1 \$116.00 |
| SPACER KIT | | | |
| Brake Hose Relocation Kit | | | 1205K 1 \$59.00 |
| GREASABLE SHACKLES AND PINS | | | |
| Greasable Shackle | | | 1199 2 \$59.00 |
| Non-Greasable Pin | | | 387-1 2 \$30.00 |
| HELPER SPRINGS | | | |
| Load Plus Helper Springs | | | LP3 1 \$165.00 |
| Add-A-Leaf | | | ISL6010 1 \$175.00 |

SUSPENSION KIT - Specify Front Coil Springs When Ordering

| | | |
|------------------------|------------|-----------|
| Light - Nitro Gas | MITS047AKG | \$2172.00 |
| Light - Foam Cell | MITS047AKF | \$2375.00 |
| Medium - Nitro Gas | MITS047BKG | \$2172.00 |
| Medium - Foam Cell | MITS047BKF | \$2375.00 |
| Medium - Foam Cell Pro | MITS047BKP | \$3759.00 |
| Heavy - Nitro Gas | MITS047CKG | \$2231.00 |
| Heavy - Foam Cell | MITS047CKF | \$2433.00 |
| Heavy - Foam Cell Pro | MITS047CKP | \$3817.00 |

• Two piece tailshaft models may experience driveline vibration, use 1201K to reduce vibration

SUSPENSION KIT CONTENTS

| | | | |
|-----------------------|--------------|--|---------------------------|
| Shock Absorbers | Coil Springs | Upper Control Arms (Foam Cell Pro Kits Only) | Brake Hose Relocation Kit |
| Leaf Springs | U-Bolts | Polyurethane Spring Bushes | Centre Bearing Spacer Kit |
| Strut Shock Absorbers | | | |

Ford F150

2015 to 2020



Product Description

Part No.

Qty
Req

Retail
ea Inc GST

Please check vehicle date range (if shown) next to product description prior to ordering

ACCESSORIES TO SUIT FORD F150 - 2015-2020

SLIDE-AWAY ROLL UP HARD TONNEAU COVER

Electric with Remote Control - 6.5' Bed
Electric with Remote Control - 5.8' Bed

ISLIDEAWAY073-E
ISLIDEAWAY075-E

\$2821.00
\$2716.00

ATLAS ROOF RACK KITS

Platform S with Blade Fit Kit to Suit Slideaway Hard Tonneau Cover - 1390mm Length
Crossbar (x 2) and Fit Kit to Suit Slideaway Hard Tonneau Cover - 1500mm Width
• See Page 36 and 37 for more Atlas rack and crossbar options.

IFRSLDAWAYPSK
IFRSLDAWAYC2K

\$1670.00
\$940.00

BREATHER KIT

Universal Twin Manifold Filtered Breather Kit

IDIFFBRE

\$115.00





9/2018 to 2022

Ford Ranger Raptor

Product Description

Part No.

Qty
Req

Retail
ea Inc GST

Please check vehicle date range (if shown) next to product description prior to ordering

ACCESSORIES TO SUIT FORD RANGER RAPTOR - 9/2018-2022

TOWING

| | | | |
|--|---------|--|-----------|
| Rear Protection Towbar - Full Rear Bumper Replacement (60.3mm bar) | RTB069 | | \$1495.00 |
| Towbar Wiring Loom - Plug and Play* | ITBL054 | | \$353.00 |

*Must use ITBL054 for towbar installations on vehicles with autonomous braking and an Electronic Brake Controller is being installed.

BATTERY TRAY - DUAL CAB ONLY

| | | | |
|-------------------|-----------|--|----------|
| Suits 10" Battery | IBTRAY054 | | \$201.00 |
|-------------------|-----------|--|----------|

LOCKSAFE DRAWER SYSTEMS - FITS DUAL AND EXTRA CAB

| | | | |
|------------------------|---------|--|-----------|
| Twin Drawers - 1300mm | ITD1300 | | \$1536.00 |
| Single Drawer - 1300mm | ISD1300 | | \$932.00 |
| Wing Kit - 1300mm* | ITDW037 | | \$367.00 |

*Designed to suit factory tubs, will not suit ute liner without modification.

CANOPY - PINNACLE SMOOTH FINISH FIBREGLASS (SIDE LIFT UP WINDOWS AND CENTRAL LOCKING REAR DOOR) - FITS 4X4 AND 4X2 DUAL CAB MODELS

| | | | |
|----------------------|----------------|--|-----------|
| Frozen White (WVZ) | CANFIBRE054-FW | | \$3763.00 |
| Magnetic Grey (WVQ) | CANFIBRE054-M | | \$3763.00 |
| Blue Lightning (SW3) | CANFIBRE054-BL | | \$3763.00 |
| Shadow Black (U0) | CANFIBRE054-SB | | \$3763.00 |
| Arctic White (SWU) | CANFIBRE054-AW | | \$3763.00 |

• Includes tub strengthening bracket (CANOPY010 BRACKET)

CANOPY - PINNACLE 2 FIBREGLASS (SIDE LIFT UP WINDOWS AND CENTRAL LOCKING REAR DOOR) - FITS 4X4 AND 4X2 DUAL CAB MODELS

| | | | |
|--------------------------------|---------------|--|-----------|
| Pre-Primed | ICANOPY054-P | | \$3213.00 |
| Aluminium Metallic (SWR) (38P) | ICANOPY054-AM | | \$3763.00 |
| Arctic White (SWU) | ICANOPY054-AW | | \$3763.00 |
| Blue Lightning (SW3) | ICANOPY054-BL | | \$3763.00 |
| Frozen White (WVZ) | ICANOPY054-FW | | \$3763.00 |
| Meteor Grey (42A) (SWT) | ICANOPY054-G | | \$3763.00 |
| Shadow Black (U0) | ICANOPY054-SB | | \$3763.00 |

* Pre-primed canopies, plus colour coding.

TUB STRENGTHENING BRACKET

| | | | |
|---|-------------------|--|---------|
| To suit all Canopies - (Must be fitted) | CANOPY010 BRACKET | | \$54.00 |
|---|-------------------|--|---------|

SLIDE-AWAY ROLL UP HARD TONNEAU COVER

| | | | |
|--|-------------------|--|-----------|
| Electric with Remote Control | ISLIDEAWAY054-E | | \$2716.00 |
| Sports Bar Adaptor - Compatible with XLT, Raptor, Raptor X and FX4 sports bars | ISLIDEAWAY054-SBA | | \$177.00 |

ATLAS ROOF RACK KITS

| | | | |
|--|---------------|--|-----------|
| Platform A with Blade Fit Kit - 1530mm Length | IFR054PAK | | \$1816.00 |
| Crossbar (x 2) and Fit Kit - 1250mm Width | IFR054C2K | | \$699.00 |
| Platform K with Leg Fit Kit to Suit Pinnacle 2 Canopy - 1390mm Length | IFRP2PKK | | \$1294.00 |
| Crossbar (x 2) and Fit Kit to Suit Pinnacle 2 Canopy - 1250mm Width | IFRP2C125K | | \$564.00 |
| Platform S with Blade Fit Kit to Suit Slideaway Hard Tonneau Cover - 1390mm Length | IFRSLDAWAYPSK | | \$1670.00 |
| Crossbar (x 2) and Fit Kit to Suit Slideaway Hard Tonneau Cover - 1500mm Width | IFRSLDAWAYC2K | | \$940.00 |

• See Page 36 and 37 for more Atlas rack and crossbar options.

SEAT COVER

| | | | |
|------------------------|----------|--|----------|
| Canvas Comfort - Front | ICSC069F | | \$420.00 |
| Canvas Comfort - Rear | ICSC055R | | \$420.00 |

BREATHER KIT

| | | | |
|---|----------|--|----------|
| Universal Twin Manifold Filtered Breather Kit | IDIFFBRE | | \$115.00 |
|---|----------|--|----------|

SUSPENSION TO SUIT FORD RANGER RAPTOR - 9/2018-2022

FRONT SUSPENSION

COIL SPRINGS

| | Est. Lift | Additional Load | | | |
|-------|-----------|-----------------|---------|---|----------|
| Light | 30mm | 0 - 50kg | FOR007A | 1 | \$262.00 |

REAR SUSPENSION

COIL SPRINGS

| | Est. Lift | Additional Load | | | |
|-------|-----------|-----------------|---------|---|----------|
| Light | 30mm | 0 - 200kg | FOR008A | 1 | \$262.00 |



Ford Ranger

Next-Gen 2022+
Excludes Ranger Raptor



| Product Description | DATE AVAILABLE | Part No. | Qty Req | Retail ea Inc GST |
|---------------------|----------------|----------|---------|-------------------|
|---------------------|----------------|----------|---------|-------------------|

Please check vehicle date range (if shown) next to product description prior to ordering

ACCESSORIES TO SUIT FORD RANGER - 2022+

| | | | | |
|---|---------|-------------------|--|-----------|
| STEEL WINCH BULL BARS | | | | |
| Commercial - Includes Integrated Recovery Points | Q4 2022 | BBC110 | | \$1934.00 |
| Commercial Deluxe - Includes Integrated Recovery Points | Q4 2022 | BBCD110 | | \$2561.00 |
| Premium - 60.3mm Tube | Q1 2023 | BBP110 | | \$2770.00 |
| Raid Full Length Steel Bumper - Includes Integrated Recovery Points | Q4 2022 | BBR110 | | \$2299.00 |
| Bull Bar Multi-Function Light Patch Loom | Q4 2022 | IBBPL110 | | \$173.00 |
| Driving Light / Lightbar Patch Loom | | IPL110 | | \$85.00 |
| Polyurethane Override Kit to Suit BBR110 Raid Bar | Q4 2022 | BBPART046 | | \$89.00 |
| Winch Control Extension Plug - 1500mm Length | Q4 2022 | WWB032 | | \$37.00 |
| Winch Control Box Mount | Q4 2022 | WWBCP110 | | \$89.00 |
| • Winch with Steel Cable and Roller Fairlead is not suitable - Use Winch with Synthetic Rope and Alloy Hawse only | | | | |
| STEEL SIDE STEPS AND RAILS - FITS DUAL CAB MODELS ONLY | | | | |
| Side Steps | Q1 2023 | SS110 | | \$1055.00 |
| Side Rails | Q1 2023 | SS110 RAIL | | \$317.00 |
| Side Steps and Rails | Q1 2023 | SSR110 | | \$1276.00 |
| TOWING | | | | |
| Class 4 Towbar - Compatible with Factory Rear Bumper (Excludes Wildtrak and Raptor) | Q1 2023 | TB110 | | \$608.00 |
| Rear Protection Towbar - Full Rear Bumper Replacement | Q4 2022 | RTB110 | | \$1411.00 |
| Rear Protection Bumper - Compatible with OEM Towbar | Q1 2023 | RPB110 | | \$941.00 |
| Towbar Wiring Loom - Plug and Play* | | ITBL110 | | \$518.00 |
| *Must use ITBL110 on vehicles with AEB and an Electronic Brake Controller is being fitted. | | | | |
| SNORKEL | | | | |
| (Excludes Raptor) | | ISNORKEL110 | | \$437.00 |
| BATTERY TRAY - DUAL CAB ONLY | | | | |
| Suits 10" Battery | | IBTRAY054 | | \$201.00 |
| PREMIUM UNDERBODY PROTECTION | | | | |
| Engine Bay and Transmission | Q1 2023 | UBP110 | | \$550.00 |
| LOCKSAFE DRAWER SYSTEMS - FITS DUAL AND EXTRA CAB | | | | |
| Twin Drawers - 1300mm | | ITD1300 | | \$1536.00 |
| Single Drawer - 1300mm | | ISD1300 | | \$932.00 |
| CANOPY - PINNACLE 2 FIBREGLASS (SIDE LIFT UP WINDOWS AND CENTRAL LOCKING REAR DOOR) - FITS 4X4 AND 4X2 DUAL CAB MODELS | | | | |
| Pre-Primed | Q4 2022 | ICANOPY110-P | | \$3213.00 |
| Arctic White (SWU) | Q4 2022 | ICANOPY110-AW | | \$3763.00 |
| Meteor Grey (42A) (SWT) | Q4 2022 | ICANOPY110-G | | \$3763.00 |
| Shadow Black (UO) | | ICANOPY110-SB | | \$3763.00 |
| * Pre-primed canopies, plus colour coding. | | | | |
| • Requires tub reinforcing brackets when fitting Pinnacle 2 Canopy | | | | |
| SLIDE-AWAY ROLL UP HARD TONNEAU COVER | | | | |
| Electric with Remote Control - Compatible with all models (Excludes Wildtrak) | | ISLIDEAWAY110-E | | \$2716.00 |
| Sports Bar Adaptor - Compatible with all models (Excludes Wildtrak) | | ISLIDEAWAY110-SBA | | \$177.00 |
| • Requires tub reinforcing brackets when fitting Slide-Away tonneau cover | | | | |
| • Not suitable for Wildtrak models | | | | |
| ATLAS DUAL CAB ROOF RACK KITS | | | | |
| Platform A with Blade Fit Kit (Excludes Wildtrak) - 1530mm Length | | IFR054PAK | | \$1816.00 |
| Platform A with Blade Fit Kit (Suits Wildtrak Dual Cab Only) - 1530mm Length | Q4 2022 | IFR110WTPAK | | \$1618.00 |
| Crossbar (x 2) and Fit Kit (Excludes Wildtrak) -1250mm Width | | IFR054C2K | | \$699.00 |
| Crossbar (x 2) and Fit Kit (Suits Wildtrak Dual Cab Only) -1250mm Width | Q4 2022 | IFR110WTC2K | | \$564.00 |
| Platform K with Leg Fit Kit to Suit Pinnacle 2 Canopy - 1390mm Length | | IFRP2PKK | | \$1294.00 |
| Crossbar (x 2) and Fit Kit to Suit Pinnacle 2 Canopy - 1250mm Width | | IFRP2C125K | | \$564.00 |
| Platform S with Blade Fit Kit to Suit Slideaway Hard Tonneau Cover - 1390mm Length | | IFRSLDAWAYPSK | | \$1670.00 |
| Crossbar (x 2) and Fit Kit to Suit Slideaway Hard Tonneau Cover - 1500mm Width | | IFRSLDAWAYC2K | | \$940.00 |
| • See Page 36 and 37 for more Atlas rack and crossbar options. | | | | |
| FENDER FLARE KITS | | | | |
| Matte Black Smooth Finish 6" (Suits Non-Blindspot Sensor Models Only) | Q4 2022 | IFF60110XL | | \$499.00 |
| Matte Black Smooth Finish 6" (Suits Models with Blindspot Sensors in Flare) | Q4 2022 | IFF60110WT | | \$499.00 |
| Fender Flare Extension Kit to suit BBC/BBCD Bars | | IFFEXT110 | | \$150.00 |
| Fender Flare Extension Kit to suit Raid Bars | | IFFEXT110R | | \$150.00 |
| BREATHER KIT | | | | |
| Universal Twin Manifold Filtered Breather Kit | | IDIFFBRE | | \$115.00 |

Ford Ranger

Next-Gen 2022+
Excludes Ranger Raptor



| Product Description | DATE AVAILABLE | Part No. | Qty Req | Retail ea Inc GST |
|---------------------|----------------|----------|---------|-------------------|
|---------------------|----------------|----------|---------|-------------------|

Please check vehicle date range (if shown) next to product description prior to ordering

SUSPENSION TO SUIT FORD RANGER - 2022+

FRONT SUSPENSION

SHOCK ABSORBER

| | | | | |
|-----------------------------------|--|----------------|---|----------|
| Nitro Gas Strut - Performance | | 12885GR | 2 | \$232.00 |
| Foam Cell Strut - Performance | | 24885FE | 2 | \$262.00 |
| Foam Cell Pro Strut - Performance | | 45885FE | 2 | \$406.00 |

| COIL SPRINGS | Est. Lift | Additional Load | | | |
|---------------------|-----------|-----------------|----------------|---|----------|
| Light - No Bar | 40mm | 0 - 50kg | FOR010A | 1 | \$262.00 |
| Medium - Bar Only | 50mm | 0 - 80kg | FOR010B | 1 | \$262.00 |
| Heavy - Bar / Winch | 50mm | 80 - 120kg | FOR010C | 1 | \$262.00 |

• For V6 models, to achieve stated ride height add HILFR05F or adjust Pro seat height to 198mm

STRUT MOUNTS

| | | | | |
|-----------------|--|----------------|---|----------|
| Steel Strut Top | | ISST110 | 2 | \$102.00 |
|-----------------|--|----------------|---|----------|

TRIM PACKERS

| | | | | |
|------------------------|-----------------------|-------------------------|---|---------|
| 5mm Strut Trim Packer | Nitro Gas / Foam Cell | HILFR05/HILFR05F | 2 | \$30.00 |
| 10mm Strut Trim Packer | Nitro Gas / Foam Cell | HILFR10/HILFR10F | 2 | \$30.00 |
| 15mm Strut Trim Packer | Nitro Gas / Foam Cell | HILFR15/HILFR15F | 2 | \$30.00 |

• ONLY Compatible with Ironman 4x4 Struts (except Pro), lift height subject to 2:1 motion ratio. Unnecessary fitment may lift vehicle too high

CONTROL ARMS

| | | | | |
|------------------------------|----------------|-----------------|---|----------|
| Pro-Forge Upper Control Arms | Q2 2023 | UCA110FA | 1 | \$922.00 |
|------------------------------|----------------|-----------------|---|----------|

REAR SUSPENSION

SHOCK ABSORBER

| | | | | |
|------------------------------|--|-----------------|---|----------|
| Nitro Gas - Comfort | | 12886GRC | 2 | \$160.00 |
| Nitro Gas - Performance | | 12886GR | 2 | \$160.00 |
| Foam Cell - Comfort | | 24886FEC | 2 | \$232.00 |
| Foam Cell - Performance | | 24886FE | 2 | \$232.00 |
| Foam Cell Pro - Comfort | | 45886FEC | 2 | \$319.00 |
| Foam Cell Pro - Performance | | 45886FE | 2 | \$319.00 |
| Foam Cell Pro - Professional | | 45886FEP | 2 | \$319.00 |

| LEAF SPRINGS | Est. Lift | Additional Load | | | |
|--------------|-----------|-----------------|------------------|---|----------|
| Light | 40mm | 0 - 200kg | FOR012A | 2 | \$392.00 |
| Medium | 45mm | 0 - 300kg | FOR012B | 2 | \$392.00 |
| Heavy | 45mm | 300kg - 600kg | FOR012C | 2 | \$421.00 |
| Extra Heavy | 45mm | 600kg - GVM | FOR012D | 2 | \$471.00 |
| Extra Leaf* | | | FOR012XL3 | 2 | \$63.00 |

* Suits Ironman 4x4 springs only

• Possible driveline vibration may occur due to increased ride height, use 1223K to reduce vibration to satisfactory level

U-BOLTS

| | | | | |
|------------|--|---------------|---|---------|
| U-Bolt Kit | | 438UBK | 2 | \$44.00 |
|------------|--|---------------|---|---------|

POLYURETHANE SPRING BUSHES

| | | | | |
|----------|--|---------------|---|----------|
| Bush Kit | | 1193UK | 1 | \$175.00 |
|----------|--|---------------|---|----------|

SPACER KITS

| | | | | |
|---------------------------|--|--------------|---|---------|
| Centre Bearing Spacer Kit | | 1223K | 1 | \$44.00 |
|---------------------------|--|--------------|---|---------|

GREASABLE SHACKLES AND PINS

| | | | | |
|-------------------|--|--------------|---|---------|
| Greasable Shackle | | 1147 | 2 | \$59.00 |
| Non-Greasable Pin | | 387-1 | 2 | \$30.00 |

SUSPENSION KIT - Specify Front Coil Springs When Ordering

| | | |
|-----------------------------|------------------|-----------|
| Light - Nitro Gas | FOR010AKG | \$2135.00 |
| Light - Foam Cell | FOR010AKF | \$2338.00 |
| Light - Foam Cell Pro | FOR010AKP | \$2800.00 |
| Medium - Nitro Gas | FOR010BKG | \$2135.00 |
| Medium - Foam Cell | FOR010BKF | \$2338.00 |
| Medium - Foam Cell Pro | FOR010BKP | \$2800.00 |
| Heavy - Nitro Gas | FOR010CKG | \$2192.00 |
| Heavy - Foam Cell | FOR010CKF | \$2395.00 |
| Heavy - Foam Cell Pro | FOR010CKP | \$2856.00 |
| Extra Heavy - Nitro Gas | FOR010DKG | \$2250.00 |
| Extra Heavy - Foam Cell | FOR010DKF | \$2453.00 |
| Extra Heavy - Foam Cell Pro | FOR010DKP | \$2915.00 |

• Possible driveline vibration may occur due to increased ride height, use 1223K to reduce vibration to satisfactory level

SUSPENSION KIT CONTENTS

| | | | |
|-----------------------|--------------|----------------------------|---------------------------|
| Shock Absorbers | Coil Springs | U-Bolts | Centre Bearing Spacer Kit |
| Strut Shock Absorbers | Leaf Springs | Polyurethane Spring Bushes | |





Ford Ranger

Product Description

Part No.

Qty
Req

Retail
ea Inc GST

Please check vehicle date range (if shown) next to product description prior to ordering

ACCESSORIES TO SUIT FORD RANGER - 8/2018-2022

STEEL WINCH BULL BARS

| | | |
|--|------------------|-----------|
| Commercial - With parking sensor provisions Without Tech Pack | BBC055 | \$1754.00 |
| Commercial Deluxe - With parking sensor provisions Without Tech Pack | BBCD055 | \$2387.00 |
| Commercial Deluxe - With or Without Tech Pack | BBCD066 | \$2387.00 |
| Proguard No Loop - With or Without Tech Pack | BBT066-NL | \$1973.00 |
| Proguard Single Loop Kit | BB066-SL | \$352.00 |
| Proguard Triple Loop Kit | BB066-TL | \$423.00 |
| Driving Light / Lightbar Patch Loom | IPL066 | \$38.00 |
| Parking Sensor Holder Kit | PSH066E | \$44.00 |

- Winch with Steel Cable and Roller Fairlead is not suitable for use with BBCD066 and BBT066 - Use Winch with Synthetic Rope and Alloy Hawse only
- Can also be fitted to both 2WD and 4WD models.

STEEL SIDE STEPS AND RAILS - FITS DUAL CAB MODELS ONLY

| | | |
|----------------------|-------------------|-----------|
| Side Steps | SS054 | \$1006.00 |
| Side Rails | SS054 RAIL | \$332.00 |
| Side Steps and Rails | SSR054 | \$1207.00 |

TOWING

| | | |
|---|--------------------|-----------|
| Class 4 Towbar - Compatible with Factory Rear Bumper (Not Wildtrak) | TB066 | \$608.00 |
| Rear Protection Towbar - Full Rear Bumper Replacement | RTB066 | \$1388.00 |
| Rear Protection Towbar Plates (Pair) | RTBPLATE001 | \$153.00 |
| Towbar Wiring Loom - Plug and Play* | ITBL054 | \$353.00 |

*Must use ITBL054 for towbar installations on vehicles with autonomous braking and an Electronic Brake Controller is being installed.

RECOVERY POINTS - IRONMAN 4X4 BULL BAR ONLY

| | | |
|--|---------------|----------|
| Recovery Points - 5000kg Rating (Pair) | IRP054 | \$340.00 |
|--|---------------|----------|

SNORKEL

| | | |
|---------------------------------------|-----------------------|----------|
| XL - (with side indicator) | ISNORKEL034 | \$437.00 |
| XLT - (with indicator on side mirror) | ISNORKEL034XLT | \$437.00 |

BATTERY TRAY - DUAL CAB ONLY

| | | |
|-------------------|------------------|----------|
| Suits 10" Battery | IBTRAY054 | \$201.00 |
|-------------------|------------------|----------|

LONG RANGE FUEL TANK

| | | |
|---|----------------|-----------|
| 140L* - Suitable for 3.2L Diesel Dual Cab, Extra Cab and Single Cab | TANK007 | \$1180.00 |
|---|----------------|-----------|

*Usable volume may differ to the stated tank capacity

PREMIUM UNDERBODY PROTECTION

| | | |
|---|---------------|----------|
| Engine Bay and Transmission - DPF Models (Retains factory transmission plate) | UBP055 | \$550.00 |
|---|---------------|----------|

LOCKSAFE DRAWER SYSTEMS - FITS DUAL AND EXTRA CAB

| | | |
|------------------------|----------------|-----------|
| Twin Drawers - 1300mm | ITD1300 | \$1536.00 |
| Single Drawer - 1300mm | ISD1300 | \$932.00 |
| Wing Kit - 1300mm* | ITDW037 | \$367.00 |

*Designed to suit factory tubs, will not suit ute liner without modification.

Ford Ranger

PX Mk III 8/2018 to 2022
WITH or WITHOUT Tech Pack
Adaptive Cruise Control

| Product Description | Part No. | Qty Req | Retail ea Inc GST |
|--|-------------------|------------|----------------------|
| <i>Please check vehicle date range (if shown) next to product description prior to ordering</i> | | | |
| CANOPY - ABS PLASTIC (SIDE LIFT UP WINDOWS AND CENTRAL LOCKING REAR DOOR) - FITS 4X4 AND 4X2 DUAL CAB MODELS | | | |
| Pre-Primed | CANOPY010-P † | | \$3238.00 |
| Winning Blue (WVW) | CANOPY010-WB | | \$3856.00 |
| Magnetic Grey (WVQ) | CANOPY010-M † | | \$3856.00 |
| ABS Canopy Rack Feet | IRRFEETABS14 | | \$287.00 |
| <ul style="list-style-type: none"> • Includes tub strengthening bracket (CANOPY010 BRACKET) • Colour code and build date must be confirmed for Aluminium Metallic Canopies (CANOPY010-AM) • See Page 38 for 1.4m Roof Rack options and pricing. | | | |
| † With central locking | | | |
| CANOPY - PINNACLE SMOOTH FINISH FIBREGLASS (SIDE LIFT UP WINDOWS AND CENTRAL LOCKING REAR DOOR) - FITS 4X4 AND 4X2 DUAL CAB MODELS | | | |
| Frozen White (WVZ) | CANFIBRE054-FW | | \$3763.00 |
| Magnetic Grey (WVQ) | CANFIBRE054-M | | \$3763.00 |
| Blue Lightning (SW3) | CANFIBRE054-BL | | \$3763.00 |
| Shadow Black (UO) | CANFIBRE054-SB | | \$3763.00 |
| Arctic White (SWU) | CANFIBRE054-AW | | \$3763.00 |
| • Includes tub strengthening bracket (CANOPY010 BRACKET) | | | |
| CANOPY - PINNACLE 2 FIBREGLASS (SIDE LIFT UP WINDOWS AND CENTRAL LOCKING REAR DOOR) - FITS 4X4 AND 4X2 DUAL CAB MODELS | | | |
| Pre-Primed | ICANOPY054-P | | \$3213.00 |
| Aluminium Metallic (SWR) (38P) | ICANOPY054-AM | | \$3763.00 |
| Arctic White (SWU) | ICANOPY054-AW | | \$3763.00 |
| Blue Lightning (SW3) | ICANOPY054-BL | | \$3763.00 |
| Frozen White (WVZ) | ICANOPY054-FW | | \$3763.00 |
| Meteor Grey (42A) (SWT) | ICANOPY054-G | | \$3763.00 |
| Shadow Black (UO) | ICANOPY054-SB | | \$3763.00 |
| * Pre-primed canopies, plus colour coding. | | | |
| TUB STRENGTHENING BRACKET | | | |
| To suit all Canopies - (Must be fitted) | CANOPY010 BRACKET | | \$54.00 |
| SLIDE-AWAY ROLL UP HARD TONNEAU COVER | | | |
| Electric with Remote Control | ISLIDEAWAY054-E | | \$2716.00 |
| Sports Bar Adaptor - Compatible with XLT, Raptor, Raptor X and FX4 sports bars | ISLIDEAWAY054-SBA | | \$177.00 |
| • Not suitable for Wildtrak models | | | |
| ATLAS DUAL CAB ROOF RACK KITS | | | |
| Platform A with Blade Fit Kit (Suits PXIII Dual Cab Only) - 1530mm Length | IFR054PAK | | \$1816.00 |
| Platform A with Blade Fit Kit (Suits Wildtrak Dual Cab Only) - 1530mm Length | IFR054WTPAK | | \$1608.00 |
| Crossbar (x 2) and Fit Kit (Suits PXIII and Wildtrak Dual Cab) - 1250mm Width | IFR054C2K | | \$699.00 |
| Platform K with Leg Fit Kit to Suit Pinnacle 2 Canopy - 1390mm Length | IFRP2PKK | | \$1294.00 |
| Crossbar (x 2) and Fit Kit to Suit Pinnacle 2 Canopy - 1250mm Width | IFRP2C125K | | \$564.00 |
| Platform S with Blade Fit Kit to Suit Slideaway Hard Tonneau Cover - 1390mm Length | IFRSLDAWAYPSK | | \$1670.00 |
| Crossbar (x 2) and Fit Kit to Suit Slideaway Hard Tonneau Cover - 1500mm Width | IFRSLDAWAYC2K | | \$940.00 |
| • See Page 36 and 37 for more Atlas rack and crossbar options. | | | |
| FENDER FLARE KITS | | | |
| Matte Black Smooth Finish 6" (Suits XLS / XLT Dual Cab Only) | IFF6054XLT | | \$499.00 |
| Matte Black Smooth Finish 6" (Suits Wildtrak Dual Cab Only) | IFF6066WT | | \$499.00 |
| SEAT COVER | | | |
| Canvas Comfort - Front | ICSC054F | | \$420.00 |
| Canvas Comfort - Rear | ICSC055R | | \$420.00 |
| BREATHER KIT | | | |
| Universal Twin Manifold Filtered Breather Kit | IDIFFBRE | | \$115.00 |

LISTING
CONTINUED
OVER THE
PAGE



Ford Ranger

Product Description

Part No.

Qty Req

Retail ea Inc GST

Please check vehicle date range (if shown) next to product description prior to ordering

SUSPENSION TO SUIT FORD RANGER - 7/2018-2022

FRONT SUSPENSION

SHOCK ABSORBER

| | | | | | |
|-----------------------------------|--|--|----------------|---|----------|
| Nitro Gas Strut - Performance | | | 12827GR | 2 | \$232.00 |
| Foam Cell Strut - Performance | | | 24827FE | 2 | \$262.00 |
| Foam Cell Pro Strut - Performance | | | 45827FE | 2 | \$406.00 |

COIL SPRINGS

| | Est. Lift | Additional Load | | | |
|----------|-----------|-----------------|----------------|---|----------|
| Standard | 0mm | 0 - 50kg | FOR005S | 1 | \$262.00 |
| Light | 35mm | 0 - 50kg | FOR005A | 1 | \$262.00 |
| Medium | 40mm | 0 - 50kg | FOR005B | 1 | \$262.00 |
| Heavy | 45mm | 50 - 110kg | FOR005C | 1 | \$262.00 |

STRUT MOUNTS

| | | | | | |
|-----------------------|--|--|----------------|---|----------|
| Steel Strut Top | | | ISST055 | 2 | \$102.00 |
| Bump Stop Base Holder | | | PBC055 | 2 | \$26.00 |

TRIM PACKERS

| | | | | | |
|------------------------|-----------|--|-----------------|---|---------|
| 5mm Strut Trim Packer | Foam Cell | | HILFR05F | 2 | \$30.00 |
| 10mm Strut Trim Packer | Foam Cell | | HILFR10F | 2 | \$30.00 |
| 15mm Strut Trim Packer | Foam Cell | | HILFR15F | 2 | \$30.00 |

• ONLY Compatible with Ironman 4x4 Struts (except Pro), lift height subject to 2:1 motion ratio. Unnecessary fitment may lift vehicle too high

SWAY BAR LINK

| | | | | | |
|--------------------------|--|--|--------------|---|---------|
| Adjustable Sway Bar Link | | | 1214K | 2 | \$81.00 |
|--------------------------|--|--|--------------|---|---------|

CONTROL ARMS

| | | | | | |
|------------------------------|--|--|-----------------|---|----------|
| Pro-Forge Upper Control Arms | | | UCA054FA | 1 | \$882.00 |
|------------------------------|--|--|-----------------|---|----------|

REAR SUSPENSION

SHOCK ABSORBER

| | | | | | |
|------------------------------|--|--|-----------------|---|----------|
| Nitro Gas - Comfort | | | 12095GRC | 2 | \$160.00 |
| Nitro Gas - Performance | | | 12095GR | 2 | \$160.00 |
| Foam Cell - Comfort | | | 24095FEC | 2 | \$232.00 |
| Foam Cell - Performance | | | 24095FE | 2 | \$232.00 |
| Foam Cell - Professional | | | 24095FEP | 2 | \$232.00 |
| Foam Cell Pro - Comfort | | | 45095FEC | 2 | \$319.00 |
| Foam Cell Pro - Performance | | | 45095FE | 2 | \$319.00 |
| Foam Cell Pro - Professional | | | 45095FEP | 2 | \$319.00 |

LEAF SPRINGS

| | Est. Lift | Additional Load | | | |
|--------|-----------|-----------------|----------------|---|----------|
| Light | 40mm | 0 - 200kg | FOR002A | 2 | \$392.00 |
| Medium | 45mm | 0 - 300kg | FOR002B | 2 | \$392.00 |
| Heavy | 45mm | 300kg - GVM | FOR002C | 2 | \$421.00 |

• Possible driveline vibration may occur due to increased ride height, use 1194K to reduce vibration to satisfactory level

U-BOLTS

| | | | | | |
|------------|--|--|---------------|---|---------|
| U-Bolt Kit | | | 417UBK | 2 | \$44.00 |
|------------|--|--|---------------|---|---------|

POLYURETHANE SPRING BUSHES

| | | | | | |
|----------|--|--|---------------|---|----------|
| Bush Kit | | | 1193UK | 1 | \$175.00 |
|----------|--|--|---------------|---|----------|

DRIVELINE SPACERS

| | | | | | |
|---------------------------|--|--|--------------|---|---------|
| Centre Bearing Spacer Kit | | | 1194K | 1 | \$44.00 |
|---------------------------|--|--|--------------|---|---------|

GREASABLE SHACKLES AND PINS

| | | | | | |
|-------------------|--|--|--------------|---|---------|
| Greasable Shackle | | | 1147 | 2 | \$59.00 |
| Non-Greasable Pin | | | 387-1 | 2 | \$30.00 |

HELPER SPRINGS

| | | | | | |
|--------------------------|--|--|----------------|---|----------|
| Load Plus Helper Springs | | | LP3 | 1 | \$165.00 |
| Add-A-Leaf | | | ISL6010 | 1 | \$175.00 |



PX Mk III
Not USA Model
7/2018 to 2022

SUSPENSION TO SUIT

Ford Ranger

Product Description

Part No.

**Qty
Req**

**Retail
ea Inc GST**

Please check vehicle date range (if shown) next to product description prior to ordering

SUSPENSION KIT - Specify Front Coil Springs When Ordering

| | | |
|------------------------|------------------|-----------|
| Light - Nitro Gas | FOR005AKG | \$2129.00 |
| Light - Foam Cell | FOR005AKF | \$2332.00 |
| Light - Foam Cell Pro | FOR005AKP | \$2795.00 |
| Medium - Nitro Gas | FOR005BKG | \$2129.00 |
| Medium - Foam Cell | FOR005BKF | \$2332.00 |
| Medium - Foam Cell Pro | FOR005BKP | \$2795.00 |
| Heavy - Nitro Gas | FOR005CKG | \$2187.00 |
| Heavy - Foam Cell | FOR005CKF | \$2389.00 |
| Heavy - Foam Cell Pro | FOR005CKP | \$2852.00 |

• Possible driveline vibration may occur due to increased ride height, use 1194K to reduce vibration to satisfactory level

SUSPENSION KIT CONTENTS

| | | | |
|-----------------------|--------------|----------------------------|---------------------------|
| Shock Absorbers | Coil Springs | U-Bolts | Centre Bearing Spacer Kit |
| Strut Shock Absorbers | Leaf Springs | Polyurethane Spring Bushes | |



OPTIONS AVAILABLE FOR THIS VEHICLE - SEE PAGE 378





Ford Ranger

Product Description

Part No.

Qty
Req

Retail
ea Inc GST

Please check vehicle date range (if shown) next to product description prior to ordering

ACCESSORIES TO SUIT FORD RANGER - 2015-7/2018

STEEL WINCH BULL BARS

| | | |
|--|-----------|-----------|
| Commercial - With parking sensor provisions Without Tech Pack | BBC055 | \$1754.00 |
| Commercial Deluxe - With parking sensor provisions Without Tech Pack | BBCD055 | \$2387.00 |
| Commercial Deluxe - With or Without Tech Pack | BBCD054 | \$2387.00 |
| Proguard No Loop - With or Without Tech Pack | BBT054-NL | \$1973.00 |
| Proguard Single Loop Kit | BB054-SL | \$352.00 |
| Proguard Triple Loop Kit | BB054-TL | \$423.00 |
| Driving Light / Lightbar Patch Loom | IPL066 | \$38.00 |
| Parking Sensor Holder Kit | PSH066E | \$44.00 |

• Can also be fitted to both 2WD and 4WD models.

STEEL SIDE STEPS AND RAILS - FITS DUAL AND SINGLE CAB MODELS ONLY

| | | |
|----------------------|------------|-----------|
| Side Steps | SS054 | \$1006.00 |
| Side Rails | SS054 RAIL | \$332.00 |
| Side Steps and Rails | SSR054 | \$1207.00 |

TOWING

| | | |
|---|-------------|-----------|
| Class 4 Towbar - Compatible with Factory Rear Bumper (Not Wildtrak) | TB066 | \$608.00 |
| Rear Protection Towbar - Full Rear Bumper Replacement | RTB066 | \$1388.00 |
| Rear Protection Towbar Plates (Pair) | RTBPLATE001 | \$153.00 |
| Towbar Wiring Loom - Plug and Play | ITBL054 | \$353.00 |
| Towbar Wiring Loom - Plug and Play 12 Pin Flat | ITBL054-12P | \$466.00 |

RECOVERY POINTS - IRONMAN 4X4 BULL BAR ONLY

| | | |
|--|--------|----------|
| Recovery Points - 5000kg Rating (Pair) | IRP054 | \$340.00 |
|--|--------|----------|

SNORKEL

| | | |
|---------------------------------------|----------------|----------|
| XL - (with side indicator) | ISNORKELO34 | \$437.00 |
| XLT - (with indicator on side mirror) | ISNORKELO34XLT | \$437.00 |

BATTERY TRAY- DUAL CAB ONLY

| | | |
|-------------------|-----------|----------|
| Suits 10" Battery | IBTRAY054 | \$201.00 |
|-------------------|-----------|----------|

LONG RANGE FUEL TANK

| | | |
|---|---------|-----------|
| 140L* - Suitable for 3.2L Diesel Dual Cab, Extra Cab and Single Cab | TANK007 | \$1180.00 |
|---|---------|-----------|

* Usable volume may differ to the stated tank capacity

PREMIUM UNDERBODY PROTECTION

| | | |
|---|--------|----------|
| Engine Bay and Transmission - Non DPF Models | UBP054 | \$782.00 |
| Engine Bay and Transmission - DPF Models (Retains factory transmission plate) | UBP055 | \$550.00 |

UNDERBODY PROTECTION

| | | |
|---|---------|----------|
| Engine Bay and Transmission - While Stocks Last | IUP014K | \$494.00 |
|---|---------|----------|

LOCKSAFE DRAWER SYSTEMS - FITS DUAL AND EXTRA CAB

| | | |
|------------------------|---------|-----------|
| Twin Drawers - 1300mm | ITD1300 | \$1536.00 |
| Single Drawer - 1300mm | ISD1300 | \$932.00 |
| Wing Kit - 1300mm* | ITDW037 | \$367.00 |

*Designed to suit factory tubs, will not suit ute liner without modification.



Ford Ranger



PX Mk II 2015 to 7/2018
WITH or WITHOUT Tech Pack
Adaptive Cruise Control

| Product Description | Part No. | Qty Req | Retail ea Inc GST |
|--|-------------------|---------|-------------------|
| CANOPY - ABS PLASTIC (SIDE LIFT UP WINDOWS AND CENTRAL LOCKING REAR DOOR) - FITS 4X4 AND 4X2 DUAL CAB MODELS | | | |
| Pre-Primed | CANOPY010-P† | | \$3238.00 |
| Winning Blue (WVW) | CANOPY010-WB | | \$3856.00 |
| Magnetic Grey (WVQ) | CANOPY010-M† | | \$3856.00 |
| ABS Canopy Rack Feet | IRRFEEABS14 | | \$287.00 |
| <ul style="list-style-type: none"> • Includes tub strengthening bracket (CANOPY010 BRACKET) • Colour code and build date must be confirmed for Aluminium Metallic Canopies (CANOPY010-AM) • See Page 38 for 1.4m Roof Rack options and pricing. | | | |
| † With central locking | | | |
| CANOPY - PINNACLE SMOOTH FINISH FIBREGLASS (SIDE LIFT UP WINDOWS AND CENTRAL LOCKING REAR DOOR) - FITS 4X4 AND 4X2 DUAL CAB MODELS | | | |
| Frozen White (WVZ) | CANFIBRE054-FW | | \$3763.00 |
| Magnetic Grey (WVQ) | CANFIBRE054-M | | \$3763.00 |
| Blue Lightning (SW3) | CANFIBRE054-BL | | \$3763.00 |
| Shadow Black (UO) | CANFIBRE054-SB | | \$3763.00 |
| Arctic White (SWU) | CANFIBRE054-AW | | \$3763.00 |
| • Includes tub strengthening bracket (CANOPY010 BRACKET) | | | |
| CANOPY - PINNACLE 2 FIBREGLASS (SIDE LIFT UP WINDOWS AND CENTRAL LOCKING REAR DOOR) - FITS 4X4 AND 4X2 DUAL CAB MODELS | | | |
| Pre-Primed | ICANOPY054-P | | \$3213.00 |
| Aluminium Metallic (SWR) (38P) | ICANOPY054-AM | | \$3763.00 |
| Arctic White (SWU) | ICANOPY054-AW | | \$3763.00 |
| Blue Lightning (SW3) | ICANOPY054-BL | | \$3763.00 |
| Frozen White (WVZ) | ICANOPY054-FW | | \$3763.00 |
| Meteor Grey (42A) (SWT) | ICANOPY054-G | | \$3763.00 |
| Shadow Black (UO) | ICANOPY054-SB | | \$3763.00 |
| * Pre-primed canopies, plus colour coding. | | | |
| TUB STRENGTHENING BRACKET | | | |
| To suit all Canopies - (Must be fitted) | CANOPY010 BRACKET | | \$54.00 |
| SLIDE-AWAY ROLL UP HARD TONNEAU COVER | | | |
| Electric with Remote Control | ISLIDEAWAY054-E | | \$2716.00 |
| Sports Bar Adaptor - Compatible with XLT, Raptor, Raptor X and FX4 sports bars | ISLIDEAWAY054-SBA | | \$177.00 |
| • Not suitable for Wildtrak models | | | |
| ATLAS DUAL CAB ROOF RACK KITS | | | |
| Platform A with Blade Fit Kit (Suits PXII Dual Cab Only) - 1530mm Length | IFR054PAK | | \$1816.00 |
| Platform A with Blade Fit Kit (Suits Wildtrak Dual Cab Only) - 1530mm Length | IFR054WTPAK | | \$1608.00 |
| Crossbar (x 2) and Fit Kit (Suits PXII and Wildtrak Dual Cab) - 1250mm Width | IFR054C2K | | \$699.00 |
| Platform K with Leg Fit Kit to Suit Pinnacle 2 Canopy - 1390mm Length | IFRP2PKK | | \$1294.00 |
| Crossbar (x 2) and Fit Kit to Suit Pinnacle 2 Canopy - 1250mm Width | IFRP2C125K | | \$564.00 |
| Platform S with Blade Fit Kit to Suit Slideaway Hard Tonneau Cover - 1390mm Length | IFRSLDAWAYPSK | | \$1670.00 |
| Crossbar (x 2) and Fit Kit to Suit Slideaway Hard Tonneau Cover - 1500mm Width | IFRSLDAWAYC2K | | \$940.00 |
| • See Page 36 and 37 for more Atlas rack and crossbar options. | | | |
| FENDER FLARE KITS | | | |
| Matte Black Smooth Finish 6" (Suits PXII and Wildtrak Dual Cab) | IFF6054 | | \$499.00 |
| SEAT COVER | | | |
| Canvas Comfort - Front | ICSC054F | | \$420.00 |
| Canvas Comfort - Rear | ICSC055R | | \$420.00 |
| BREATHER KIT | | | |
| Universal Twin Manifold Filtered Breather Kit | IDIFFBRE | | \$115.00 |

LISTING CONTINUED OVER THE PAGE





Product Description

Part No.

Qty
Req

Retail
ea Inc GST

Please check vehicle date range (if shown) next to product description prior to ordering

SUSPENSION TO SUIT FORD RANGER - 2015-6/2018

FRONT SUSPENSION

SHOCK ABSORBER

| | | | | | |
|-----------------------------------|--|--|----------------|---|----------|
| Nitro Gas Strut - Performance | | | 12727GR | 2 | \$232.00 |
| Foam Cell Strut - Performance | | | 24727FE | 2 | \$262.00 |
| Foam Cell Pro Strut - Performance | | | 45727FE | 2 | \$406.00 |

COIL SPRINGS

| | Est. Lift | Additional Load | | | |
|----------|-----------|-----------------|----------------|---|----------|
| Standard | 0mm | 0 - 50kg | FOR001S | 1 | \$262.00 |
| Light | 35mm | 0 - 50kg | FOR001A | 1 | \$262.00 |
| Medium | 40mm | 0 - 50kg | FOR001B | 1 | \$262.00 |
| Heavy | 45mm | 50 - 110kg | FOR001C | 1 | \$262.00 |

STRUT MOUNTS

| | | | | | |
|-----------------|--|--|----------------|---|---------|
| Steel Strut Top | | | ISST014 | 2 | \$88.00 |
|-----------------|--|--|----------------|---|---------|

TRIM PACKERS

| | | | | |
|------------------------|-----------------------|-------------------------|---|---------|
| 5mm Strut Trim Packer | Nitro Gas / Foam Cell | HILFR05/HILFR05F | 2 | \$30.00 |
| 10mm Strut Trim Packer | Nitro Gas / Foam Cell | HILFR10/HILFR10F | 2 | \$30.00 |
| 15mm Strut Trim Packer | Nitro Gas / Foam Cell | HILFR15/HILFR15F | 2 | \$30.00 |

• ONLY Compatible with Ironman 4x4 Struts (except Pro), lift height subject to 2:1 motion ratio. Unnecessary fitment may lift vehicle too high

CONTROL ARMS

| | | | | | |
|------------------------------|--|--|-----------------|---|----------|
| Pro-Forge Upper Control Arms | | | UCA054FA | 1 | \$882.00 |
|------------------------------|--|--|-----------------|---|----------|

SPACER KIT

| | | | | | |
|-------------------------|--|--|--------------|---|----------|
| Sway Bar Relocation Kit | | | 1203K | 1 | \$102.00 |
|-------------------------|--|--|--------------|---|----------|

REAR SUSPENSION

SHOCK ABSORBER

| | | | | | |
|------------------------------|--|--|-----------------|---|----------|
| Nitro Gas - Comfort | | | 12095GRC | 2 | \$160.00 |
| Nitro Gas - Performance | | | 12095GR | 2 | \$160.00 |
| Foam Cell - Comfort | | | 24095FEC | 2 | \$232.00 |
| Foam Cell - Performance | | | 24095FE | 2 | \$232.00 |
| Foam Cell - Professional | | | 24095FEP | 2 | \$232.00 |
| Foam Cell Pro - Comfort | | | 45095FEC | 2 | \$319.00 |
| Foam Cell Pro - Performance | | | 45095FE | 2 | \$319.00 |
| Foam Cell Pro - Professional | | | 45095FEP | 2 | \$319.00 |

LEAF SPRINGS

| | Est. Lift | Additional Load | | | |
|--------|-----------|-----------------|----------------|---|----------|
| Light | 40mm | 0 - 200kg | FOR002A | 2 | \$392.00 |
| Medium | 45mm | 0 - 300kg | FOR002B | 2 | \$392.00 |
| Heavy | 45mm | 300kg - GVM | FOR002C | 2 | \$421.00 |

• Possible driveline vibration may occur due to increased ride height, use 1194K to reduce vibration to satisfactory level

U-BOLTS

| | | | | | |
|------------|--|--|---------------|---|---------|
| U-Bolt Kit | | | 417UBK | 2 | \$44.00 |
|------------|--|--|---------------|---|---------|

POLYURETHANE SPRING BUSHES

| | | | | | |
|----------|--|--|---------------|---|----------|
| Bush Kit | | | 1193UK | 1 | \$175.00 |
|----------|--|--|---------------|---|----------|

DRIVELINE SPACERS

| | | | | | |
|---------------------------|--|--|--------------|---|---------|
| Centre Bearing Spacer Kit | | | 1194K | 1 | \$44.00 |
|---------------------------|--|--|--------------|---|---------|

GREASABLE SHACKLES AND PINS

| | | | | | |
|-------------------|--|--|--------------|---|---------|
| Greasable Shackle | | | 1147 | 2 | \$59.00 |
| Non-Greasable Pin | | | 387-1 | 2 | \$30.00 |

HELPER SPRINGS

| | | | | | |
|--------------------------|--|--|----------------|---|----------|
| Load Plus Helper Springs | | | LP3 | 1 | \$165.00 |
| Add-A-Leaf | | | ISL6010 | 1 | \$175.00 |



PX Mk II
Not USA Model
2015 to 6/2018

Ford Ranger

Product Description

Part No.

Qty
Req

Retail
ea Inc GST

Please check vehicle date range (if shown) next to product description prior to ordering

SUSPENSION KIT - Specify Front Coil Springs When Ordering

| | | |
|------------------------|-----------|-----------|
| Light - Nitro Gas | FOR001AKG | \$2129.00 |
| Light - Foam Cell | FOR001AKF | \$2332.00 |
| Light - Foam Cell Pro | FOR001AKP | \$2795.00 |
| Medium - Nitro Gas | FOR001BKG | \$2129.00 |
| Medium - Foam Cell | FOR001BKF | \$2332.00 |
| Medium - Foam Cell Pro | FOR001BKP | \$2795.00 |
| Heavy - Nitro Gas | FOR001CKG | \$2187.00 |
| Heavy - Foam Cell | FOR001CKF | \$2389.00 |
| Heavy - Foam Cell Pro | FOR001CKP | \$2852.00 |

• Possible driveline vibration may occur due to increased ride height, use 1194K to reduce vibration to satisfactory level

SUSPENSION KIT CONTENTS

| | | | |
|-----------------------|--------------|----------------------------|---------------------------|
| Shock Absorbers | Coil Springs | U-Bolts | Centre Bearing Spacer Kit |
| Strut Shock Absorbers | Leaf Springs | Polyurethane Spring Bushes | |



OPTIONS AVAILABLE FOR THIS VEHICLE - SEE PAGE 379

Ford Ranger

PX
7/2011 to 2015



Product Description

Part No.

Qty
Req

Retail
ea Inc GST

Please check vehicle date range (if shown) next to product description prior to ordering

ACCESSORIES TO SUIT FORD RANGER - 7/2011-2015

STEEL WINCH BULL BARS

| | | |
|-------------------------------------|-----------|-----------|
| Commercial | BBC038 | \$1723.00 |
| Commercial Deluxe | BBCD038 | \$2345.00 |
| Proguard No Loop | BBT038-NL | \$2271.00 |
| Proguard Single Loop Kit | BB038-SL | \$352.00 |
| Proguard Triple Loop Kit | BB038-TL | \$423.00 |
| Driving Light / Lightbar Patch Loom | IPL066 | \$38.00 |

• Can also be fitted to both 2WD and 4WD models.

STEEL SIDE STEPS AND RAILS - FITS DUAL AND SINGLE CAB MODELS ONLY

| | | |
|----------------------|------------|-----------|
| Side Steps | SS054 | \$1006.00 |
| Side Rails | SS054 RAIL | \$332.00 |
| Side Steps and Rails | SSR054 | \$1207.00 |

TOWING

| | | |
|---|-------------|-----------|
| Class 4 Towbar - Compatible with Factory Rear Bumper (Not Wildtrak) | TB066 | \$608.00 |
| Rear Protection Towbar - Full Rear Bumper Replacement | RTB066 | \$1388.00 |
| Rear Protection Towbar Plates (Pair) | RTBPLATE001 | \$153.00 |
| Towbar Wiring Loom - Plug and Play (PX 7/11 to 4/14 only) | ITBL039 | \$383.00 |
| Towbar Wiring Loom - Plug and Play (PX 4/14 to 7/15 only) | ITBL038 | \$371.00 |

RECOVERY POINTS - IRONMAN 4X4 BULL BAR ONLY

| | | |
|--|--------|----------|
| Recovery Points - 5000kg Rating (Pair) | IRP054 | \$340.00 |
|--|--------|----------|

SNORKEL

| | | |
|--|----------------|----------|
| 2.2 / 3.2L Diesel (Fits XL with side indicator) | ISNORKELO34 | \$437.00 |
| 2.2 / 3.2L Diesel (Fits XLT with indicator on side mirror) | ISNORKELO34XLT | \$437.00 |

BATTERY TRAYS

| | | |
|-------------------|-----------|----------|
| Suits 10" Battery | IBTRAY054 | \$201.00 |
|-------------------|-----------|----------|

LONG RANGE FUEL TANK

| | | |
|---|---------|-----------|
| 140L* - Suitable for 3.2L Diesel Dual Cab, Extra Cab and Single Cab | TANK007 | \$1180.00 |
|---|---------|-----------|

* Usable volume may differ to the stated tank capacity

PREMIUM UNDERBODY PROTECTION

| | | |
|--|--------|----------|
| Engine Bay and Transmission - Not compatible with models fitted with DPF | UBP054 | \$782.00 |
|--|--------|----------|

UNDERBODY PROTECTION

| | | |
|---|---------|----------|
| Engine Bay and Transmission - While Stocks Last | IUP014K | \$494.00 |
|---|---------|----------|

LOCKSAFE DRAWER SYSTEMS

| | | |
|------------------------|---------|-----------|
| Twin Drawers - 1300mm | ITD1300 | \$1536.00 |
| Single Drawer - 1300mm | ISD1300 | \$932.00 |
| Wing Kit - 1300mm* | ITDW037 | \$367.00 |

* Designed to suit factory tubs, will not suit ute liner without modification.



Ford Ranger

PX
7/2011 to 2015

Product Description

Part No.

Qty
ReqRetail
ea Inc GST*Please check vehicle date range (if shown) next to product description prior to ordering***CANOPY - ABS PLASTIC (SIDE LIFT UP WINDOWS AND CENTRAL LOCKING REAR DOOR) - FITS 4X4 AND 4X2 DUAL CAB MODELS**

| | | |
|----------------------|---------------|-----------|
| Pre-Primed | CANOPY010-P † | \$3238.00 |
| Winning Blue (WVW) | CANOPY010-WB | \$3856.00 |
| Magnetic Grey (WVQ) | CANOPY010-M † | \$3856.00 |
| ABS Canopy Rack Feet | IRRFEEATABS14 | \$287.00 |

- Includes tub strengthening bracket (CANOPY010 BRACKET)
- Colour code and build date must be confirmed for Aluminium Metallic Canopies (CANOPY010-AM)
- See Page 38 for 1.4m Roof Rack options and pricing.

† With central locking

CANOPY - PINNACLE SMOOTH FINISH FIBREGLASS (SIDE LIFT UP WINDOWS AND CENTRAL LOCKING REAR DOOR) - FITS 4X4 AND 4X2 DUAL CAB MODELS

| | | |
|----------------------|----------------|-----------|
| Frozen White (WVZ) | CANFIBRE054-FW | \$3763.00 |
| Magnetic Grey (WVQ) | CANFIBRE054-M | \$3763.00 |
| Blue Lightning (SW3) | CANFIBRE054-BL | \$3763.00 |
| Shadow Black (UP) | CANFIBRE054-SB | \$3763.00 |
| Arctic White (SWU) | CANFIBRE054-AW | \$3763.00 |

- Includes tub strengthening bracket (CANOPY010 BRACKET)

CANOPY - PINNACLE 2 FIBREGLASS (SIDE LIFT UP WINDOWS AND CENTRAL LOCKING REAR DOOR) - FITS 4X4 AND 4X2 DUAL CAB MODELS

| | | |
|--------------------------------|---------------|-----------|
| Pre-Primed | ICANOPY054-P | \$3213.00 |
| Aluminium Metallic (SWR) (38P) | ICANOPY054-AM | \$3763.00 |
| Arctic White (SWU) | ICANOPY054-AW | \$3763.00 |
| Blue Lightning (SW3) | ICANOPY054-BL | \$3763.00 |
| Frozen White (WVZ) | ICANOPY054-FW | \$3763.00 |
| Meteor Grey (42A) (SWT) | ICANOPY054-G | \$3763.00 |
| Shadow Black (UO) | ICANOPY054-SB | \$3763.00 |

* Pre-primed canopies, plus colour coding.

TUB STRENGTHENING BRACKET

| | | |
|---|-------------------|---------|
| To suit all Canopies - (Must be fitted) | CANOPY010 BRACKET | \$54.00 |
|---|-------------------|---------|

SLIDE-AWAY ROLL UP HARD TONNEAU COVER

| | | |
|--|-------------------|-----------|
| Electric with Remote Control | ISLIDEAWAY054-E | \$2716.00 |
| Sports Bar Adaptor - Compatible with XLT, Raptor, Raptor X and FX4 sports bars | ISLIDEAWAY054-SBA | \$177.00 |

- Not suitable for Wildtrak models

ATLAS DUAL CAB ROOF RACK KITS

| | | |
|--|---------------|-----------|
| Platform A with Blade Fit Kit (Suits PX Dual Cab Only) - 1530mm Length | IFR054PAK | \$1816.00 |
| Platform A with Blade Fit Kit (Suits Wildtrak Dual Cab Only) - 1530mm Length | IFR054WTPAK | \$1608.00 |
| Crossbar (x 2) and Fit Kit (Suits PX and Wildtrak Dual Cab) - 1250mm Width | IFR054C2K | \$699.00 |
| Platform K with Leg Fit Kit to Suit Pinnacle 2 Canopy - 1390mm Length | IFRP2PKK | \$1294.00 |
| Crossbar (x 2) and Fit Kit to Suit Pinnacle 2 Canopy - 1250mm Width | IFRP2C125K | \$564.00 |
| Platform S with Blade Fit Kit to Suit Slideaway Hard Tonneau Cover - 1390mm Length | IFRSLDAWAYPSK | \$1670.00 |
| Crossbar (x 2) and Fit Kit to Suit Slideaway Hard Tonneau Cover - 1500mm Width | IFRSLDAWAYC2K | \$940.00 |

- See Page 36 and 37 for more Atlas rack and crossbar options.

FENDER FLARE KITS

| | | |
|---|---------|----------|
| Matte Black Smooth Finish 6" (Suits PX and Wildtrak Dual Cab) | IFF6038 | \$499.00 |
|---|---------|----------|

SEAT COVER

| | | |
|------------------------|----------|----------|
| Canvas Comfort - Front | ICSC038F | \$420.00 |
| Canvas Comfort - Rear | ICSC038R | \$420.00 |

BREATHER KIT

| | | |
|---|----------|----------|
| Universal Twin Manifold Filtered Breather Kit | IDIFFBRE | \$115.00 |
|---|----------|----------|

 LISTING
CONTINUED
OVER THE
PAGE



Product Description

Part No.

Qty
Req

Retail
ea Inc GST

Please check vehicle date range (if shown) next to product description prior to ordering

SUSPENSION TO SUIT FORD RANGER - 2011-2015

FRONT SUSPENSION

SHOCK ABSORBER

| | | | | | |
|-----------------------------------|--|--|----------------|---|----------|
| Nitro Gas Strut - Performance | | | 12727GR | 2 | \$232.00 |
| Foam Cell Strut - Performance | | | 24727FE | 2 | \$262.00 |
| Foam Cell Pro Strut - Performance | | | 45727FE | 2 | \$406.00 |

COIL SPRINGS

| | Est. Lift | Additional Load | | | |
|----------|-----------|-----------------|----------------|---|----------|
| Standard | 0mm | 0 - 50kg | FOR001S | 1 | \$262.00 |
| Light | 35mm | 0 - 50kg | FOR001A | 1 | \$262.00 |
| Medium | 40mm | 0 - 50kg | FOR001B | 1 | \$262.00 |
| Heavy | 45mm | 50 - 110kg | FOR001C | 1 | \$262.00 |

STRUT MOUNTS

| | | | | | |
|-----------------|--|--|----------------|---|---------|
| Steel Strut Top | | | ISST014 | 2 | \$88.00 |
|-----------------|--|--|----------------|---|---------|

TRIM PACKERS

| | | | | |
|------------------------|-----------------------|-------------------------|---|---------|
| 5mm Strut Trim Packer | Nitro Gas / Foam Cell | HILFR05/HILFR05F | 2 | \$30.00 |
| 10mm Strut Trim Packer | Nitro Gas / Foam Cell | HILFR10/HILFR10F | 2 | \$30.00 |
| 15mm Strut Trim Packer | Nitro Gas / Foam Cell | HILFR15/HILFR15F | 2 | \$30.00 |

• ONLY Compatible with Ironman 4x4 Struts (except Pro), lift height subject to 2:1 motion ratio. Unnecessary fitment may lift vehicle too high

CONTROL ARMS

| | | | | | |
|------------------------------|--|--|-----------------|---|----------|
| Pro-Forge Upper Control Arms | | | UCA054FA | 1 | \$882.00 |
|------------------------------|--|--|-----------------|---|----------|

SPACER KIT

| | | | | | |
|-------------------------|--|--|--------------|---|----------|
| Sway Bar Relocation Kit | | | 1203K | 1 | \$102.00 |
|-------------------------|--|--|--------------|---|----------|

REAR SUSPENSION

SHOCK ABSORBER

| | | | | | |
|------------------------------|--|--|-----------------|---|----------|
| Nitro Gas - Comfort | | | 12095GRC | 2 | \$160.00 |
| Nitro Gas - Performance | | | 12095GR | 2 | \$160.00 |
| Foam Cell - Comfort | | | 24095FEC | 2 | \$232.00 |
| Foam Cell - Performance | | | 24095FE | 2 | \$232.00 |
| Foam Cell - Professional | | | 24095FEP | 2 | \$232.00 |
| Foam Cell Pro - Comfort | | | 45095FEC | 2 | \$319.00 |
| Foam Cell Pro - Performance | | | 45095FE | 2 | \$319.00 |
| Foam Cell Pro - Professional | | | 45095FEP | 2 | \$319.00 |

LEAF SPRINGS

| | Est. Lift | Additional Load | | | |
|--------|-----------|-----------------|----------------|---|----------|
| Light | 40mm | 0 - 200kg | FOR002A | 2 | \$392.00 |
| Medium | 45mm | 0 - 300kg | FOR002B | 2 | \$392.00 |
| Heavy | 45mm | 300kg - GVM | FOR002C | 2 | \$421.00 |

• Possible driveline vibration may occur due to increased ride height, use 1194K to reduce vibration to satisfactory level

U-BOLTS

| | | | | | |
|------------|--|--|---------------|---|---------|
| U-Bolt Kit | | | 417UBK | 2 | \$44.00 |
|------------|--|--|---------------|---|---------|

POLYURETHANE SPRING BUSHES

| | | | | | |
|----------|--|--|---------------|---|----------|
| Bush Kit | | | 1193UK | 1 | \$175.00 |
|----------|--|--|---------------|---|----------|

DRIVELINE SPACERS

| | | | | | |
|---------------------------|--|--|--------------|---|---------|
| Centre Bearing Spacer Kit | | | 1194K | 1 | \$44.00 |
|---------------------------|--|--|--------------|---|---------|

GREASABLE SHACKLES AND PINS

| | | | | | |
|-------------------|--|--|--------------|---|---------|
| Greasable Shackle | | | 1147 | 2 | \$59.00 |
| Non-Greasable Pin | | | 387-1 | 2 | \$30.00 |

HELPER SPRINGS

| | | | | | |
|--------------------------|--|--|----------------|---|----------|
| Load Plus Helper Springs | | | LP3 | 1 | \$165.00 |
| Add-A-Leaf | | | ISL6010 | 1 | \$175.00 |





T6 PX
Not USA Model
2011 to 2015

SUSPENSION TO SUIT

Ford Ranger

Product Description

Part No.

**Qty
Req**

**Retail
ea Inc GST**

Please check vehicle date range (if shown) next to product description prior to ordering

SUSPENSION KIT - Specify Front Coil Springs When Ordering

| | | |
|------------------------|------------------|-----------|
| Light - Nitro Gas | FOR001AKG | \$2129.00 |
| Light - Foam Cell | FOR001AKF | \$2332.00 |
| Light - Foam Cell Pro | FOR001AKP | \$2795.00 |
| Medium - Nitro Gas | FOR001BKG | \$2129.00 |
| Medium - Foam Cell | FOR001BKF | \$2332.00 |
| Medium - Foam Cell Pro | FOR001BKP | \$2795.00 |
| Heavy - Nitro Gas | FOR001CKG | \$2187.00 |
| Heavy - Foam Cell | FOR001CKF | \$2389.00 |
| Heavy - Foam Cell Pro | FOR001CKP | \$2852.00 |

• Possible driveline vibration may occur due to increased ride height, use 1194K to reduce vibration to satisfactory level

SUSPENSION KIT CONTENTS

| | | | |
|-----------------------|--------------|----------------------------|---------------------------|
| Shock Absorbers | Coil Springs | U-Bolts | Centre Bearing Spacer Kit |
| Strut Shock Absorbers | Leaf Springs | Polyurethane Spring Bushes | |



OPTIONS AVAILABLE FOR THIS VEHICLE - SEE PAGE 379



Ford Ranger

PJ / PK
2006 to 2011



Product Description

Part No.

Qty
Req

Retail
ea Inc GST

Please check vehicle date range (if shown) next to product description prior to ordering

ACCESSORIES TO SUIT FORD RANGER - 2006-2011

STEEL WINCH BULL BARS

Commercial Deluxe

BBCD014

\$2345.00

Protector - *While Stocks Last*

BBT014

\$2271.00

• *Can also be fitted to both 2WD and 4WD models.*

STEEL SIDE STEPS AND RAILS - FITS DUAL AND SINGLE CAB MODELS ONLY

Side Steps

SS008

\$1006.00

Side Steps and Rails

SSR002

\$1207.00

SNORKEL

3.0L TDi Diesel

ISNORKE021

\$437.00

LONG RANGE FUEL TANK

122L* Fits Dual and Single Cab only

TANK006

\$1180.00

* *Usable volume may differ to the stated tank capacity*

LOCKSAFE DRAWER SYSTEMS - FITS DUAL AND EXTRA CAB

Twin Drawers - 1300mm

ITD1300

\$1536.00

Single Drawer - 1300mm

ISD1300

\$932.00

BREATHER KIT

Universal Twin Manifold Filtered Breather Kit

IDIFFBRE

\$115.00



Ford Ranger

PJ / PK
Not USA Model
3/2006 to 2011

Product Description

Part No.

Qty
ReqRetail
ea Inc GST

Please check vehicle date range (if shown) next to product description prior to ordering

SUSPENSION TO SUIT FORD RANGER - 3/2006-2011

FRONT SUSPENSION

SHOCK ABSORBER

| | | | | |
|-----------------------------|--|----------------|---|----------|
| Nitro Gas - Performance | | 12667GR | 2 | \$160.00 |
| Foam Cell - Performance | | 24667FE | 2 | \$232.00 |
| Foam Cell Pro - Performance | | 45667FE | 2 | \$319.00 |

TORSION BAR

| | | | | |
|----------------------|-----------------|-----------------|---|----------|
| Uprated Torsion Bars | Duratorq Engine | MAZDA014 | 1 | \$435.00 |
| Uprated Torsion Bars | 2.5L WLT Engine | MAZDA005 | 1 | \$435.00 |

• MAZDA014 is 1024mm in length, used on most vehicles. Vehicles with 2.5L WLT Engine use MAZDA005 (924mm) Torsion Bar

• Minimum 60mm downward suspension travel required after adjustment

REAR SUSPENSION

SHOCK ABSORBER

| | | | | |
|-----------------------------|--|-----------------|---|----------|
| Nitro Gas - Comfort | | 12095GRC | 2 | \$160.00 |
| Nitro Gas - Performance | | 12095GR | 2 | \$160.00 |
| Foam Cell - Comfort | | 24095FEC | 2 | \$232.00 |
| Foam Cell - Performance | | 24095FE | 2 | \$232.00 |
| Foam Cell Pro - Comfort | | 45095FEC | 2 | \$319.00 |
| Foam Cell Pro - Performance | | 45095FE | 2 | \$319.00 |

LEAF SPRINGS

| | Est. Lift | Additional Load | | | |
|-------------|-----------|-----------------|------------------|---|----------|
| Light | 40mm | 0 - 100kg | MAZDA041A | 2 | \$392.00 |
| Medium | 40mm | 0 - 200kg | MAZDA041B | 2 | \$392.00 |
| Heavy | 40mm | 200 - 400kg | MAZDA041C | 2 | \$421.00 |
| Extra Heavy | 40mm | 400kg - GVM | MAZDA041D | 2 | \$421.00 |

U-BOLTS

| | | | | |
|------------|--|---------------|---|---------|
| U-Bolt Kit | | 417UBK | 2 | \$44.00 |
|------------|--|---------------|---|---------|

POLYURETHANE SPRING BUSHES

| | | | | |
|----------|--|--------------|---|---------|
| Bush Kit | | 759UK | 1 | \$88.00 |
|----------|--|--------------|---|---------|

GREASABLE SHACKLES AND PINS

| | | | | |
|-------------------|--|--------------|---|---------|
| Greasable Shackle | | 386-1 | 2 | \$59.00 |
|-------------------|--|--------------|---|---------|

HELPER SPRINGS

| | | | | |
|--------------------------|--|----------------|---|----------|
| Load Plus Helper Springs | | LP3 | 1 | \$165.00 |
| Add-A-Leaf | | ISL6010 | 1 | \$175.00 |

SUSPENSION KIT

| | | | | |
|-----------------------------|--|---------------------|--|-----------|
| Light - Nitro Gas | | MAZDA041 AKG | | \$2028.00 |
| Light - Foam Cell | | MAZDA041 AKF | | \$2317.00 |
| Light - Foam Cell Pro | | MAZDA041 AKP | | \$2664.00 |
| Medium - Nitro Gas | | MAZDA041 BKG | | \$2028.00 |
| Medium - Foam Cell | | MAZDA041 BKF | | \$2317.00 |
| Medium - Foam Cell Pro | | MAZDA041 BKP | | \$2664.00 |
| Heavy - Nitro Gas | | MAZDA041 CKG | | \$2085.00 |
| Heavy - Foam Cell | | MAZDA041 CKF | | \$2375.00 |
| Heavy - Foam Cell Pro | | MAZDA041 CKP | | \$2723.00 |
| Extra Heavy - Nitro Gas | | MAZDA041 DKG | | \$2085.00 |
| Extra Heavy - Foam Cell | | MAZDA041 DKF | | \$2375.00 |
| Extra Heavy - Foam Cell Pro | | MAZDA041 DKP | | \$2723.00 |

• Check Torsion Bar length before ordering.

SUSPENSION KIT CONTENTS

Shock Absorbers
Leaf Springs

Torsion Bars
U-Bolts

Polyurethane Spring Bushes

Ford Courier Ranger

Not USA Model
1985 to 2006



Product Description

Part No.

Qty
Req

Retail
ea Inc GST

Please check vehicle date range (if shown) next to product description prior to ordering

SUSPENSION TO SUIT FORD COURIER- 1985-2006

FRONT SUSPENSION

SHOCK ABSORBER

| | | | |
|-----------------------------|----------------|---|----------|
| Nitro Gas - Performance | 12667GR | 2 | \$160.00 |
| Foam Cell - Performance | 24667FE | 2 | \$232.00 |
| Foam Cell Pro - Performance | 45667FE | 2 | \$319.00 |

TORSION BAR

| | | | |
|-----------------------|-----------------|---|----------|
| Up-rated Torsion Bars | MAZDA005 | 1 | \$435.00 |
|-----------------------|-----------------|---|----------|

• Minimum 60mm downward suspension travel required after adjustment

REAR SUSPENSION

SHOCK ABSORBER

| | | | |
|------------------------------|-----------------|---|----------|
| Nitro Gas - Comfort | 12095GRC | 2 | \$160.00 |
| Nitro Gas - Performance | 12095GR | 2 | \$160.00 |
| Foam Cell - Comfort | 24095FEC | 2 | \$232.00 |
| Foam Cell - Performance | 24095FE | 2 | \$232.00 |
| Foam Cell - Professional | 24095FEP | 2 | \$232.00 |
| Foam Cell Pro - Comfort | 45095FEC | 2 | \$319.00 |
| Foam Cell Pro - Performance | 45095FE | 2 | \$319.00 |
| Foam Cell Pro - Professional | 45095FEP | 2 | \$319.00 |

LEAF SPRINGS

| | Est. Lift | Additional Load | | | |
|-------------|-----------|-----------------|------------------|---|----------|
| Light | 40mm | 0 - 100kg | MAZDA006A | 2 | \$392.00 |
| Medium | 40mm | 0 - 200kg | MAZDA006B | 2 | \$392.00 |
| Heavy | 40mm | 200 - 400kg | MAZDA006C | 2 | \$392.00 |
| Extra Heavy | 40mm | 400kg - GVM | MAZDA006D | 2 | \$421.00 |

U-BOLTS

| | | | |
|------------|---------------|---|---------|
| U-Bolt Kit | 415UBK | 2 | \$44.00 |
|------------|---------------|---|---------|

POLYURETHANE SPRING BUSHES

| | | | |
|----------|--------------|---|---------|
| Bush Kit | 756UK | 1 | \$88.00 |
|----------|--------------|---|---------|

GREASABLE SHACKLES AND PINS

| | | | |
|-------------------|--------------|---|---------|
| Greasable Shackle | 386-1 | 2 | \$59.00 |
| Greasable Pin | 794 | 2 | \$44.00 |

HELPER SPRINGS

| | | | |
|--------------------------|----------------|---|----------|
| Load Plus Helper Springs | LP3 | 1 | \$165.00 |
| Add-A-Leaf | ISL6010 | 1 | \$175.00 |

SUSPENSION KIT

| | | |
|-----------------------------|--------------------|-----------|
| Light - Nitro Gas | MAZDA006AKG | \$2028.00 |
| Light - Foam Cell | MAZDA006AKF | \$2317.00 |
| Light - Foam Cell Pro | MAZDA006AKP | \$2664.00 |
| Medium - Nitro Gas | MAZDA006BKG | \$2028.00 |
| Medium - Foam Cell | MAZDA006BKF | \$2317.00 |
| Medium - Foam Cell Pro | MAZDA006BKP | \$2664.00 |
| Heavy - Nitro Gas | MAZDA006CKG | \$2028.00 |
| Heavy - Foam Cell | MAZDA006CKF | \$2317.00 |
| Heavy - Foam Cell Pro | MAZDA006CKP | \$2664.00 |
| Extra Heavy - Nitro Gas | MAZDA006DKG | \$2085.00 |
| Extra Heavy - Foam Cell | MAZDA006DKF | \$2375.00 |
| Extra Heavy - Foam Cell Pro | MAZDA006DKP | \$2723.00 |

SUSPENSION KIT CONTENTS

| | | |
|-----------------|--------------|----------------------------|
| Shock Absorbers | Torsion Bars | Polyurethane Spring Bushes |
| Leaf Springs | U-Bolts | |



UAll 7/2018 to 2022
WITH or WITHOUT Tech Pack
Adaptive Cruise Control

| Product Description | Part No. | Qty Req | Retail ea Inc GST |
|---------------------|----------|------------|----------------------|
|---------------------|----------|------------|----------------------|

Please check vehicle date range (if shown) next to product description prior to ordering

ACCESSORIES TO SUIT FORD EVEREST- 7/2018-2022

STEEL WINCH BULL BARS

| | | | |
|--|-----------|--|-----------|
| Commercial - With parking sensor provisions Without Tech Pack | BBC055 | | \$1754.00 |
| Commercial Deluxe - With parking sensor provisions Without Tech Pack | BBCD055 | | \$2387.00 |
| Commercial Deluxe - With or Without Tech Pack | BBCD066 | | \$2387.00 |
| Proguard No Loop - With or Without Tech Pack | BBT066-NL | | \$1973.00 |
| Proguard Single Loop Kit | BB066-SL | | \$352.00 |
| Proguard Triple Loop Kit | BB066-TL | | \$423.00 |
| Driving Light / Lightbar Patch Loom | IPL066 | | \$38.00 |
| Parking Sensor Holder Kit | PSH066E | | \$44.00 |

- Winch with Steel Cable and Roller Fairlead is not suitable for use with BBCD066 and BBT066 - Use Winch with Synthetic Rope and Alloy Hawse only
- Can also be fitted to both 2WD and 4WD models.

STEEL SIDE STEPS AND RAILS

| | | | |
|----------------------|------------|--|-----------|
| Side Steps | SS055 | | \$1006.00 |
| Side Rails | SS055 RAIL | | \$332.00 |
| Side Steps and Rails | SSR055 | | \$1207.00 |

RECOVERY POINTS - IRONMAN 4X4 BULL BAR ONLY

| | | | |
|--|--------|--|----------|
| Recovery Points - 5000kg Rating (Pair) | IRP054 | | \$340.00 |
|--|--------|--|----------|

SNORKEL

| | | | |
|--------------|----------------|--|----------|
| UAll Everest | ISNORKEL034XLT | | \$437.00 |
|--------------|----------------|--|----------|

PREMIUM UNDERBODY PROTECTION

| | | | |
|---|--------|--|----------|
| Engine Bay and Transmission - DPF Models (Retains factory transmission plate) | UBP055 | | \$550.00 |
|---|--------|--|----------|

SEAT COVER

| | | | |
|------------------------|----------|--|----------|
| Canvas Comfort - Front | ICSC054F | | \$420.00 |
| Canvas Comfort - Rear | ICSC054R | | \$420.00 |

BREATHER KIT

| | | | |
|---|----------|--|----------|
| Universal Twin Manifold Filtered Breather Kit | IDIFFBRE | | \$115.00 |
|---|----------|--|----------|





Product Description

Part No.

Qty
Req

Retail
ea Inc GST

Please check vehicle date range (if shown) next to product description prior to ordering

SUSPENSION TO SUIT FORD EVEREST- 7/2018-2022

FRONT SUSPENSION

SHOCK ABSORBER

| | | | | | |
|-----------------------------------|--|--|----------------|---|----------|
| Nitro Gas Strut - Performance | | | 12827GR | 2 | \$232.00 |
| Foam Cell Strut - Performance | | | 24827FE | 2 | \$262.00 |
| Foam Cell Pro Strut - Performance | | | 45827FE | 2 | \$406.00 |

COIL SPRINGS

| | Est. Lift | Additional Load | | | |
|----------|-----------|-----------------|----------------|---|----------|
| Standard | 0mm | 0 - 50kg | FOR005S | 1 | \$262.00 |
| Medium | 40mm | 0 - 50kg | FOR005A | 1 | \$262.00 |
| Heavy | 45mm | 50 - 110kg | FOR005B | 1 | \$262.00 |

STRUT MOUNTS

| | | | | | |
|-----------------------|--|--|----------------|---|----------|
| Steel Strut Top | | | ISST055 | 2 | \$102.00 |
| Bump Stop Base Holder | | | PBC055 | 2 | \$26.00 |

TRIM PACKERS

| | | | | | |
|------------------------|--|-----------|-----------------|---|---------|
| 5mm Strut Trim Packer | | Foam Cell | HILFR05F | 2 | \$30.00 |
| 10mm Strut Trim Packer | | Foam Cell | HILFR10F | 2 | \$30.00 |
| 15mm Strut Trim Packer | | Foam Cell | HILFR15F | 2 | \$30.00 |

• ONLY Compatible with Ironman 4x4 Struts (except Pro), lift height subject to 2:1 motion ratio. Unnecessary fitment may lift vehicle too high

SWAY BAR LINK

| | | | | | |
|--------------------------|--|--|--------------|---|---------|
| Adjustable Sway Bar Link | | | 1214K | 2 | \$81.00 |
|--------------------------|--|--|--------------|---|---------|

CONTROL ARMS

| | | | | | |
|------------------------------|--|--|-----------------|---|----------|
| Pro-Forge Upper Control Arms | | | UCA054FA | 1 | \$882.00 |
|------------------------------|--|--|-----------------|---|----------|

REAR SUSPENSION

SHOCK ABSORBER

| | | | | | |
|--|--|--|----------------|---|----------|
| Nitro Gas - Performance ¹ | | | 12732GR | 2 | \$160.00 |
| Foam Cell - Performance ¹ | | | 24732FE | 2 | \$232.00 |
| Foam Cell Pro - Performance ² | | | 45732FE | 2 | \$319.00 |

¹ Refit original bump stop and shock absorber dust cover.

² Refit original bump stop with supplied Ironman 4x4 dust boot.

COIL SPRINGS

| | Est. Lift | Additional Load | | | |
|--------|-----------|-----------------|----------------|---|----------|
| Medium | 45mm | 0 - 300kg | FOR003B | 1 | \$305.00 |
| Heavy | 45mm | 300kg - GVM | FOR003C | 1 | \$305.00 |

SUSPENSION KIT - Specify Front Coil Springs When Ordering

| | | |
|------------------------|-------------------|-----------|
| Medium - Nitro Gas | FOR003BKG1 | \$1348.00 |
| Medium - Foam Cell | FOR003BKF1 | \$1550.00 |
| Medium - Foam Cell Pro | FOR003BKP1 | \$2013.00 |
| Heavy - Nitro Gas | FOR003CKG1 | \$1348.00 |
| Heavy - Foam Cell | FOR003CKF1 | \$1550.00 |
| Heavy - Foam Cell Pro | FOR003CKP1 | \$2013.00 |

SUSPENSION KIT CONTENTS

Shock Absorbers

Strut Shock Absorbers

Coil Springs



9/2015 to 6/2018
WITH or WITHOUT Tech Pack
Adaptive Cruise Control

Product Description

Part No.

Qty
Req

Retail
ea Inc GST

Please check vehicle date range (if shown) next to product description prior to ordering

ACCESSORIES TO SUIT FORD EVEREST- 9/2015-6/2018

STEEL WINCH BULL BARS

| | | |
|--|-----------|-----------|
| Commercial - With parking sensor provisions Without Tech Pack | BBC055 | \$1754.00 |
| Commercial Deluxe - With parking sensor provisions Without Tech Pack | BBCD055 | \$2387.00 |
| Commercial Deluxe - With or Without Tech Pack | BBCD054 | \$2387.00 |
| Proguard No Loop - With or Without Tech Pack | BBT054-NL | \$1973.00 |
| Proguard Single Loop Kit | BB054-SL | \$352.00 |
| Proguard Triple Loop Kit | BB054-TL | \$423.00 |
| Driving Light / Lightbar Patch Loom | IPL066 | \$38.00 |
| Parking Sensor Holder Kit | PSH066E | \$44.00 |

• Can also be fitted to both 2WD and 4WD models.

STEEL SIDE STEPS AND RAILS

| | | |
|----------------------|------------|-----------|
| Side Steps | SS055 | \$1006.00 |
| Side Rails | SS055 RAIL | \$332.00 |
| Side Steps and Rails | SSR055 | \$1207.00 |

RECOVERY POINTS - IRONMAN 4X4 BULL BAR ONLY

| | | |
|--|--------|----------|
| Recovery Points - 5000kg Rating (Pair) | IRP054 | \$340.00 |
|--|--------|----------|

PREMIUM UNDERBODY PROTECTION

| | | |
|-----------------------------|--------|----------|
| Engine Bay and Transmission | UBP054 | \$782.00 |
|-----------------------------|--------|----------|

UNDERBODY PROTECTION

| | | |
|---|---------|----------|
| Engine Bay and Transmission - While Stocks Last | IUP014K | \$494.00 |
|---|---------|----------|

SEAT COVER

| | | |
|------------------------|----------|----------|
| Canvas Comfort - Front | ICSC054F | \$420.00 |
| Canvas Comfort - Rear | ICSC054R | \$420.00 |

BREATHER KIT

| | | |
|---|----------|----------|
| Universal Twin Manifold Filtered Breather Kit | IDIFFBRE | \$115.00 |
|---|----------|----------|





Product Description

Part No.

Qty
Req

Retail
ea Inc GST

Please check vehicle date range (if shown) next to product description prior to ordering

SUSPENSION TO SUIT FORD EVEREST- 2015-6/2018

FRONT SUSPENSION

SHOCK ABSORBER

| | | | | | |
|-----------------------------------|--|--|----------------|---|----------|
| Nitro Gas Strut - Performance | | | 12727GR | 2 | \$232.00 |
| Foam Cell Strut - Performance | | | 24727FE | 2 | \$262.00 |
| Foam Cell Pro Strut - Performance | | | 45727FE | 2 | \$406.00 |

COIL SPRINGS

| | Est. Lift | Additional Load | | | |
|----------|-----------|-----------------|----------------|---|----------|
| Standard | 0mm | 0 - 50kg | FOR001S | 1 | \$262.00 |
| Medium | 40mm | 0 - 50kg | FOR001A | 1 | \$262.00 |
| Heavy | 40mm | 50 - 100kg | FOR001B | 1 | \$262.00 |

STRUT MOUNTS

| | | | | | |
|-----------------|--|--|----------------|---|---------|
| Steel Strut Top | | | ISST014 | 2 | \$88.00 |
|-----------------|--|--|----------------|---|---------|

TRIM PACKERS

| | | | | |
|------------------------|-----------------------|-------------------------|---|---------|
| 5mm Strut Trim Packer | Nitro Gas / Foam Cell | HILFR05/HILFR05F | 2 | \$30.00 |
| 10mm Strut Trim Packer | Nitro Gas / Foam Cell | HILFR10/HILFR10F | 2 | \$30.00 |
| 15mm Strut Trim Packer | Nitro Gas / Foam Cell | HILFR15/HILFR15F | 2 | \$30.00 |

• ONLY Compatible with Ironman 4x4 Struts (except Pro), lift height subject to 2:1 motion ratio. Unnecessary fitment may lift vehicle too high

CONTROL ARMS

| | | | | | |
|------------------------------|--|--|-----------------|---|----------|
| Pro-Forge Upper Control Arms | | | UCA054FA | 1 | \$882.00 |
|------------------------------|--|--|-----------------|---|----------|

REAR SUSPENSION

SHOCK ABSORBER

| | | | | | |
|--|--|--|----------------|---|----------|
| Nitro Gas - Performance ¹ | | | 12732GR | 2 | \$160.00 |
| Foam Cell - Performance ¹ | | | 24732FE | 2 | \$232.00 |
| Foam Cell Pro - Performance ² | | | 45732FE | 2 | \$319.00 |

¹ Refit original bump stop and shock absorber dust cover.

² Refit original bump stop with supplied Ironman 4x4 dust boot.

COIL SPRINGS

| | Est. Lift | Additional Load | | | |
|--------|-----------|-----------------|----------------|---|----------|
| Medium | 45mm | 0 - 300kg | FOR003B | 1 | \$305.00 |
| Heavy | 45mm | 300kg - GVM | FOR003C | 1 | \$305.00 |

SUSPENSION KIT - Specify Front Coil Springs When Ordering

| | | |
|------------------------|------------------|-----------|
| Medium - Nitro Gas | FOR003BKG | \$1348.00 |
| Medium - Foam Cell | FOR003BKF | \$1550.00 |
| Medium - Foam Cell Pro | FOR003BKP | \$2013.00 |
| Heavy - Nitro Gas | FOR003CKG | \$1348.00 |
| Heavy - Foam Cell | FOR003CKF | \$1550.00 |
| Heavy - Foam Cell Pro | FOR003CKP | \$2013.00 |

SUSPENSION KIT CONTENTS

| | | |
|-----------------|-----------------------|--------------|
| Shock Absorbers | Strut Shock Absorbers | Coil Springs |
|-----------------|-----------------------|--------------|



1500
2019+

GM / Chevrolet Silverado

Product Description

Part No.

Qty
ReqRetail
ea Inc GST

Please check vehicle date range (if shown) next to product description prior to ordering

ACCESSORIES TO SUIT GM / CHEVROLET SILVERADO - 2019+

STEEL WINCH BULL BARS

Raid Full Length Steel Tubular Bumper

BBR087E

\$2064.00

• Raid Bull Bars are compatible with Ironman 4x4 Lightbars and Cube Lights, refer below for available options

LIGHTING OPTIONS - TO SUIT RAID BULL BARS

300W Bright Sabre Dual Row Slim Lightbar 815mm (32") Straight

ILBDR002B

1

\$417.00

40W Bright Cube Spot Beam LED Cube Light - 81 x 75mm (Each) - Clear

ILED80B

2

\$83.00

40W Bright Cube Spot Beam LED Cube Light - 81 x 75mm (Each) - Amber

ILED80BA

2

\$83.00

40W Bright Cube Flood Beam LED Cube Light - 81 x 75mm (Each) - Clear

ILED80BF

2

\$83.00

40W Bright Cube Flood Beam LED Cube Light - 81 x 75mm (Each) - Amber

ILED80BFA

2

\$83.00

STEEL SIDE STEPS AND RAILS

Raid Side Steps

SS087

\$1098.00

REAR PROTECTION

Raid Steel Rear Tubular Bumper - (US Only)

RTB087

\$1620.00

Raid Steel Rear Tubular Bumper - (Australia Only)

RTB087AU

\$1550.00

LIGHTING OPTIONS - TO SUIT RAID REAR BARS

20W Bright Cube Spot Beam LED Cube Light - 70 x 64mm (Each) - Clear

ILED20B

2

\$62.00

20W Bright Cube Spot Beam LED Cube Light - 70 x 64mm (Each) - Amber

ILED20BA

2

\$62.00

20W Bright Cube Flood Beam LED Cube Light - 70 x 64mm (Each) - Clear

ILED20BF

2

\$62.00

20W Bright Cube Flood Beam LED Cube Light - 70 x 64mm (Each) - Amber

ILED20BFA

2

\$62.00

20W Bright Cube Flood Beam LED Cube Light - 70 x 64mm (Each) - Red

ILED20BFR

2

\$62.00

SLIDE-AWAY ROLL UP HARD TONNEAU COVER

Electric with Remote Control (Long Bed)

ISLIDEAWAY087L-E

\$2821.00

Electric with Remote Control (Short Bed)

ISLIDEAWAY087S-E

\$2716.00

ATLAS ROOF RACK KITS

Platform S with Blade Fit Kit to Suit Slideaway Hard Tonneau Cover - 1390mm Length

IFRSLDAWAYPSK

\$1670.00

Crossbar (x 2) and Fit Kit to Suit Slideaway Hard Tonneau Cover - 1500mm Width

IFRSLDAWAYC2K

\$940.00

• See Page 36 and 37 for more Atlas rack and crossbar options.

BREATHER KIT

Universal Twin Manifold Filtered Breather Kit

IDIFFBRE

\$115.00

GM / Holden Jackaroo

Bighorn / Monterey
1992+



Product Description

Part No.

Qty
Req

Retail
ea Inc GST

Please check vehicle date range (if shown) next to product description prior to ordering

SUSPENSION TO SUIT GM / HOLDEN JACKAROO - 1992+

FRONT SUSPENSION

SHOCK ABSORBER

| | | | |
|-------------------------|----------------|---|----------|
| Nitro Gas - Performance | 12643GR | 2 | \$160.00 |
| Foam Cell - Performance | 24643FE | 2 | \$232.00 |

TORSION BAR

| | | | |
|-----------------------|----------------|---|----------|
| Up-rated Torsion Bars | HOLD009 | 1 | \$435.00 |
|-----------------------|----------------|---|----------|

• Minimum 60mm downward suspension travel required after adjustment

REAR SUSPENSION

SHOCK ABSORBER

| | | | |
|-------------------------|----------------|---|----------|
| Nitro Gas - Performance | 12644GR | 2 | \$160.00 |
| Foam Cell - Performance | 24644FE | 2 | \$232.00 |

COIL SPRINGS

| | Est. Lift | Additional Load | | | |
|--------|-----------|-----------------|-----------------|---|----------|
| Medium | 40mm | 0 - 300kg | HOLD008B | 1 | \$262.00 |
| Heavy | 40mm | 300kg - GVM | HOLD008C | 1 | \$262.00 |

• Use HOLD008C for 3/2001+ Models

SUSPENSION KIT

| | | |
|--------------------|-------------------|-----------|
| Medium - Nitro Gas | HOLD008BKG | \$1333.00 |
| Medium - Foam Cell | HOLD008BKF | \$1622.00 |
| Heavy - Nitro Gas | HOLD008CKG | \$1333.00 |
| Heavy - Foam Cell | HOLD008CKF | \$1622.00 |

SUSPENSION KIT CONTENTS

Shock Absorbers

Coil Springs

Torsion Bars





11/1986 to 1991

GM / Holden Jackaroo

Product Description

Part No.

Qty
Req

Retail
ea Inc GST

Please check vehicle date range (if shown) next to product description prior to ordering

SUSPENSION TO SUIT GM / HOLDEN JACKAROO - 11/1986-1991

FRONT SUSPENSION

SHOCK ABSORBER

| | | | | |
|-------------------------|--|----------------|---|----------|
| Nitro Gas - Performance | | 12087GR | 2 | \$160.00 |
| Foam Cell - Performance | | 24087FE | 2 | \$232.00 |

TORSION BAR

| | | | | |
|----------------------|-------------------|-----------------|---|----------|
| Uprated Torsion Bars | 43mm Spline Count | HOLD005A | 1 | \$435.00 |
|----------------------|-------------------|-----------------|---|----------|

• Minimum 60mm downward suspension travel required after adjustment

REAR SUSPENSION

SHOCK ABSORBER

| | | | | |
|-------------------------|--|----------------|---|----------|
| Nitro Gas - Performance | | 12671GR | 2 | \$160.00 |
|-------------------------|--|----------------|---|----------|

LEAF SPRINGS

| | Est. Lift | Additional Load | | |
|-----------------------|-----------|-----------------|--------------------|------------|
| Medium - Drivers Side | 40mm | 0 - 300kg | HOLD004BD/S | 1 \$392.00 |
| Medium - Near Side | 40mm | 0 - 300kg | HOLD004BN/S | 1 \$392.00 |
| Heavy - Drivers Side | 40mm | 300kg - GVM | HOLD004CD/S | 1 \$421.00 |
| Heavy - Near Side | 40mm | 300kg - GVM | HOLD004CN/S | 1 \$421.00 |

U-BOLTS

| | | | | |
|------------|--|---------------|---|---------|
| U-Bolt Kit | | 451UBK | 2 | \$44.00 |
|------------|--|---------------|---|---------|

POLYURETHANE SPRING BUSHES

| | | | | |
|----------|--|--------------|---|---------|
| Bush Kit | | 747UK | 1 | \$88.00 |
|----------|--|--------------|---|---------|

GREASABLE SHACKLES AND PINS

| | | | | |
|-------------------|--|------------|---|---------|
| Greasable Shackle | | 791 | 2 | \$59.00 |
| Greasable Pin | | 792 | 2 | \$44.00 |

HELPER SPRINGS

| | | | | |
|--------------------------|--|----------------|---|----------|
| Load Plus Helper Springs | | LP3 | 1 | \$165.00 |
| Add-A-Leaf | | ISL6010 | 1 | \$175.00 |

SUSPENSION KIT

| | | | | |
|--------------------|--|-------------------|--|-----------|
| Medium - Nitro Gas | | HOLD007BKG | | \$2317.00 |
| Medium - Foam Cell | | HOLD007BKF | | \$2461.00 |
| Heavy - Nitro Gas | | HOLD007CKG | | \$1953.00 |
| Heavy - Foam Cell | | HOLD007CKF | | \$2520.00 |

SUSPENSION KIT CONTENTS

| | | |
|-----------------|--------------|----------------------------|
| Shock Absorbers | Torsion Bars | Polyurethane Spring Bushes |
| Leaf Springs | U-Bolts | |





Product Description

Part No.

**Qty
Req**

**Retail
ea Inc GST**

Please check vehicle date range (if shown) next to product description prior to ordering

SUSPENSION TO SUIT GM / HOLDEN JACKAROO - PRE 1986

FRONT SUSPENSION

SHOCK ABSORBER

| | | | |
|-------------------------|----------------|---|----------|
| Nitro Gas - Performance | 12087GR | 2 | \$160.00 |
| Foam Cell - Performance | 24087FE | 2 | \$232.00 |

TORSION BAR

| | | | |
|-----------------------|-----------------|---|----------|
| Up-rated Torsion Bars | MAZDA005 | 1 | \$435.00 |
|-----------------------|-----------------|---|----------|

• Minimum 60mm downward suspension travel required after adjustment

REAR SUSPENSION

SHOCK ABSORBER

| | | | |
|-------------------------|-----------------|---|----------|
| Nitro Gas - Comfort | 12636GRC | 2 | \$160.00 |
| Nitro Gas - Performance | 12636GR | 2 | \$160.00 |
| Foam Cell - Comfort | 24636FEC | 2 | \$232.00 |
| Foam Cell - Performance | 24636FE | 2 | \$232.00 |

LEAF SPRINGS

| | Est. Lift | Additional Load | | | |
|-----------------------|-----------|-----------------|--------------------|---|----------|
| Medium - Drivers Side | 40mm | 0 - 300kg | HOLD004BD/S | 1 | \$392.00 |
| Medium - Near Side | 40mm | 0 - 300kg | HOLD004BN/S | 1 | \$392.00 |
| Heavy - Drivers Side | 40mm | 300kg - GVM | HOLD004CD/S | 1 | \$421.00 |
| Heavy - Near Side | 40mm | 300kg - GVM | HOLD004CN/S | 1 | \$421.00 |

U-BOLTS

| | | | |
|------------|---------------|---|---------|
| U-Bolt Kit | 451UBK | 2 | \$44.00 |
|------------|---------------|---|---------|

POLYURETHANE SPRING BUSHES

| | | | |
|----------|--------------|---|---------|
| Bush Kit | 747UK | 1 | \$88.00 |
|----------|--------------|---|---------|

GREASABLE SHACKLES AND PINS

| | | | |
|-------------------|------------|---|---------|
| Greasable Shackle | 791 | 2 | \$59.00 |
| Greasable Pin | 792 | 2 | \$44.00 |

HELPER SPRINGS

| | | | |
|--------------------------|----------------|---|----------|
| Load Plus Helper Springs | LP3 | 1 | \$165.00 |
| Add-A-Leaf | ISL6010 | 1 | \$175.00 |

SUSPENSION KIT

| | | |
|--------------------|-------------------|-----------|
| Medium - Nitro Gas | HOLD005BKG | \$2028.00 |
| Medium - Foam Cell | HOLD005BKF | \$2317.00 |
| Heavy - Nitro Gas | HOLD005CKG | \$2085.00 |
| Heavy - Foam Cell | HOLD005CKF | \$2375.00 |

SUSPENSION KIT CONTENTS

| | | |
|-----------------|--------------|----------------------------|
| Shock Absorbers | Torsion Bars | Polyurethane Spring Bushes |
| Leaf Springs | U-Bolts | |





1995 to 1/1999

GM / Holden Frontera

Product Description

Part No.

Qty
Req

Retail
ea Inc GST

Please check vehicle date range (if shown) next to product description prior to ordering

SUSPENSION TO SUIT GM / HOLDEN JACKAROO - 1995-1/1999

FRONT SUSPENSION

SHOCK ABSORBER

| | | | |
|-------------------------|----------------|---|----------|
| Nitro Gas - Performance | 12667GR | 2 | \$160.00 |
| Foam Cell - Performance | 24667FE | 2 | \$232.00 |

TORSION BAR

| | | | |
|----------------------|----------------|---|----------|
| Uprated Torsion Bars | HOLD009 | 1 | \$435.00 |
|----------------------|----------------|---|----------|

• Minimum 60mm downward suspension travel required after adjustment

REAR SUSPENSION

SHOCK ABSORBER

| | | | |
|-------------------------|----------------|---|----------|
| Nitro Gas - Performance | 12644GR | 2 | \$160.00 |
| Foam Cell - Performance | 24644FE | 2 | \$232.00 |

COIL SPRINGS

| | Est. Lift | Additional Load | | |
|--------|-----------|-----------------|-----------------|---|
| Medium | 45mm | 0 - 300kg | HOLD008B | 1 |
| Heavy | 45mm | 300kg - GVM | HOLD008C | 1 |

SUSPENSION KIT

| | | |
|--------------------|--------------------|-----------|
| Medium - Nitro Gas | HOLD008BKG1 | \$1333.00 |
| Medium - Foam Cell | HOLD008BKF1 | \$1622.00 |
| Heavy - Nitro Gas | HOLD008CKG1 | \$1333.00 |
| Heavy - Foam Cell | HOLD008CKF1 | \$1622.00 |

SUSPENSION KIT CONTENTS

Shock Absorbers

Coil Springs

Torsion Bars

GM / Holden Trailblazer

LT / LTZ
2017+



Product Description

Part No.

Qty
Req

Retail
ea Inc GST

Please check vehicle date range (if shown) next to product description prior to ordering

ACCESSORIES TO SUIT GM / HOLDEN TRAILBLAZER - 2017+

STEEL WINCH BULL BARS

| | | |
|-------------------------------------|-----------|-----------|
| Commercial | BBC057 | \$1754.00 |
| Commercial Deluxe | BBCD057 | \$2387.00 |
| Proguard No Loop | BBT057-NL | \$1973.00 |
| Proguard Single Loop Kit | BB057-SL | \$352.00 |
| Proguard Triple Loop Kit | BB057-TL | \$423.00 |
| Driving Light / Lightbar Patch Loom | IPL057 | \$33.00 |

• Can also be fitted to both 2WD and 4WD models.

STEEL SIDE STEPS AND RAILS - FITS DUAL CAB MODELS ONLY

| | | |
|----------------------|------------|-----------|
| Side Steps | SS044 | \$1006.00 |
| Side Rails | SS044 RAIL | \$332.00 |
| Side Steps and Rails | SSR044 | \$1207.00 |

RECOVERY POINTS - IRONMAN 4X4 BULL BAR ONLY

| | | |
|---|--------|----------|
| Recovery Points (One piece, two points) - 5000kg rating | IRP057 | \$396.00 |
| Recovery Points - 5000kg Rating (Pair) | IRP058 | \$323.00 |

SNORKEL

| | | |
|--------------------------|-------------|----------|
| Trailblazer LT/LTZ 2017+ | ISNORKEL036 | \$437.00 |
|--------------------------|-------------|----------|

PREMIUM UNDERBODY PROTECTION

| | | |
|-----------------------------|--------|----------|
| Engine Bay and Transmission | UBP057 | \$782.00 |
|-----------------------------|--------|----------|

STEEL ROOF RACKS

| | | |
|---------------------------------------|-----------|----------|
| Cage Style - 1.8 x 1.25m | IRRCAGE18 | \$852.00 |
| Rooftop Tent Compatible - 1.8 x 1.25m | IRRTENT18 | \$812.00 |
| Trade Style - 1.8m x 1.25m (Open end) | IRRTADE18 | \$812.00 |

ALLOY ROOF RACKS

| | | |
|---------------------------------------|------------------|-----------|
| Cage Style - 1.8m x 1.25m | IRRCAGE18-ALLOY | \$1201.00 |
| Trade Style - 1.8m x 1.25m (Open end) | IRRTADE18-ALLOY | \$1183.00 |
| Flat Rack - 1.8m x 1.25m | IRRTFLAT18-ALLOY | \$1167.00 |

STEEL AND ALLOY ROOF RACK - MOUNT KITS

| | | |
|--------------------------------------|------------|----------|
| Mount Feet (6 Feet) - Suits OE rails | IRRFEET001 | \$207.00 |
|--------------------------------------|------------|----------|

SEAT COVER

| | | |
|------------------------|----------|----------|
| Canvas Comfort - Front | ICSC040F | \$420.00 |
| Canvas Comfort - Rear | ICSC049R | \$420.00 |

BREATHER KIT

| | | |
|---|----------|----------|
| Universal Twin Manifold Filtered Breather Kit | IDIFFBRE | \$115.00 |
|---|----------|----------|





LT / LTZ
2017+

GM / Holden Trailblazer

Product Description

Part No.

Qty Req

Retail ea Inc GST

Please check vehicle date range (if shown) next to product description prior to ordering

SUSPENSION TO SUIT GM / HOLDEN TRAILBLAZER - 2017+

FRONT SUSPENSION

SHOCK ABSORBER

| | | | | | |
|-----------------------------------|--|--|----------------|---|----------|
| Nitro Gas Strut - Performance | | | 12745GR | 2 | \$232.00 |
| Foam Cell Strut - Performance | | | 24745FE | 2 | \$262.00 |
| Foam Cell Pro Strut - Performance | | | 45745FE | 2 | \$406.00 |

COIL SPRINGS

| | Est. Lift | Additional Load | | | |
|----------|-----------|-----------------|-----------------|---|----------|
| Standard | 0mm | 0 - 50kg | HOLD020S | 1 | \$262.00 |
| Light | 30mm | 0 - 50kg | HOLD020A | 1 | \$262.00 |
| Medium | 40mm | 0 - 50kg | HOLD020B | 1 | \$262.00 |
| Heavy | 40mm | 50 - 110kg | HOLD020C | 1 | \$262.00 |

STRUT MOUNTS

| | | | | | |
|-----------------|--|--|----------------|---|---------|
| Steel Strut Top | | | ISST017 | 2 | \$88.00 |
|-----------------|--|--|----------------|---|---------|

TRIM PACKERS

| | | | | |
|------------------------|-----------------------|-------------------------|---|---------|
| 5mm Strut Trim Packer | Nitro Gas / Foam Cell | HILFR05/HILFR05F | 2 | \$30.00 |
| 10mm Strut Trim Packer | Nitro Gas / Foam Cell | HILFR10/HILFR10F | 2 | \$30.00 |
| 15mm Strut Trim Packer | Nitro Gas / Foam Cell | HILFR15/HILFR15F | 2 | \$30.00 |

• ONLY Compatible with Ironman 4x4 Struts (except Pro), lift height subject to 2:1 motion ratio. Unnecessary fitment may lift vehicle too high

CONTROL ARMS

| | | | | | |
|------------------------------|--|--|-----------------|---|----------|
| Pro-Forge Upper Control Arms | | | UCA041FA | 1 | \$882.00 |
|------------------------------|--|--|-----------------|---|----------|

REAR SUSPENSION

SHOCK ABSORBER

| | | | | | |
|-----------------------------|--|--|-----------------|---|----------|
| Nitro Gas - Comfort | | | 12746GRC | 2 | \$160.00 |
| Nitro Gas - Performance | | | 12746GR | 2 | \$160.00 |
| Foam Cell - Comfort | | | 24746FEC | 2 | \$232.00 |
| Foam Cell - Performance | | | 24746FE | 2 | \$232.00 |
| Foam Cell Pro - Comfort | | | 45746FEC | 2 | \$319.00 |
| Foam Cell Pro - Performance | | | 45746FE | 2 | \$319.00 |

COIL SPRINGS

| | Est. Lift | Additional Load | | | |
|----------|-----------|-----------------|-----------------|---|----------|
| Standard | 0mm | 0 - 250kg | HOLD022S | 1 | \$262.00 |
| Light | 30mm | 0 - 250kg | HOLD022A | 1 | \$262.00 |
| Medium | 40mm | 0 - 250kg | HOLD022B | 1 | \$262.00 |
| Heavy | 45mm | 250kg - GVM | HOLD022C | 1 | \$262.00 |

SUSPENSION KIT - Specify Front Coil Springs When Ordering

| | | |
|--------------------------|-------------------|-----------|
| Standard - Nitro Gas | HOLD022SKG | \$1304.00 |
| Standard - Foam Cell | HOLD022SKF | \$1506.00 |
| Standard - Foam Cell Pro | HOLD022SKP | \$1969.00 |
| Light - Nitro Gas | HOLD022AKG | \$1304.00 |
| Light - Foam Cell | HOLD022AKF | \$1506.00 |
| Light - Foam Cell Pro | HOLD022AKP | \$1969.00 |
| Medium - Nitro Gas | HOLD022BKG | \$1304.00 |
| Medium - Foam Cell | HOLD022BKF | \$1506.00 |
| Medium - Foam Cell Pro | HOLD022BKP | \$1969.00 |
| Heavy - Nitro Gas | HOLD022CKG | \$1304.00 |
| Heavy - Foam Cell | HOLD022CKF | \$1506.00 |
| Heavy - Foam Cell Pro | HOLD022CKP | \$1969.00 |

SUSPENSION KIT CONTENTS

Shock Absorbers

Strut Shock Absorbers

Coil Springs



Product Description

Part No.

Qty
Req

Retail
ea Inc GST

Please check vehicle date range (if shown) next to product description prior to ordering

ACCESSORIES TO SUIT GM / HOLDEN COLORADO 7 - 2012+

STEEL WINCH BULL BARS

| | | |
|-------------------|---------|-----------|
| Commercial Deluxe | BBCD044 | \$2345.00 |
|-------------------|---------|-----------|

• Can also be fitted to both 2WD and 4WD models.

STEEL SIDE STEPS AND RAILS

| | | |
|----------------------|------------|-----------|
| Side Steps | SS044 | \$1006.00 |
| Side Rails | SS044 RAIL | \$332.00 |
| Side Steps and Rails | SSR044 | \$1207.00 |

RECOVERY POINTS - IRONMAN 4X4 BULL BAR ONLY

| | | |
|--|--------|----------|
| Recovery Points - 5000kg Rating (Pair) | IRP058 | \$323.00 |
|--|--------|----------|

SNORKEL

| | | |
|---------------------|-------------|----------|
| Colorado 7 RG 2012+ | ISNORKELO36 | \$437.00 |
|---------------------|-------------|----------|

PREMIUM UNDERBODY PROTECTION

| | | |
|-----------------------------|--------|----------|
| Engine Bay and Transmission | UBP041 | \$782.00 |
|-----------------------------|--------|----------|

STEEL ROOF RACKS

| | | |
|---------------------------------------|-------------|----------|
| Cage Style - 1.8 x 1.25m | IRRCAGE18 | \$852.00 |
| Rooftop Tent Compatible - 1.8 x 1.25m | IRR TENT18 | \$812.00 |
| Trade Style - 1.8m x 1.25m (Open end) | IRR TRADE18 | \$812.00 |

ALLOY ROOF RACKS

| | | |
|---------------------------------------|-------------------|-----------|
| Cage Style - 1.8m x 1.25m | IRRCAGE18-ALLOY | \$1201.00 |
| Trade Style - 1.8m x 1.25m (Open end) | IRR TRADE18-ALLOY | \$1183.00 |
| Flat Rack - 1.8m x 1.25m | IRR FLAT18-ALLOY | \$1167.00 |

STEEL AND ALLOY ROOF RACK - MOUNT KITS

| | | |
|--------------------------------------|-------------|----------|
| Mount Feet (6 Feet) - Suits OE rails | IRR FEET001 | \$207.00 |
|--------------------------------------|-------------|----------|

SEAT COVER

| | | |
|------------------------|----------|----------|
| Canvas Comfort - Front | ICSC040F | \$420.00 |
| Canvas Comfort - Rear | ICSC049R | \$420.00 |

BREATHER KIT

| | | |
|---|----------|----------|
| Universal Twin Manifold Filtered Breather Kit | IDIFFBRE | \$115.00 |
|---|----------|----------|



Trailblazer
2012+

GM / Holden Colorado 7

Product Description

Part No.

Qty
ReqRetail
ea Inc GST

Please check vehicle date range (if shown) next to product description prior to ordering

SUSPENSION TO SUIT GM / HOLDEN COLORADO 7 - 2012+

FRONT SUSPENSION

SHOCK ABSORBER

| | | | | | |
|-----------------------------------|--|--|----------------|---|----------|
| Nitro Gas Strut - Performance | | | 12745GR | 2 | \$232.00 |
| Foam Cell Strut - Performance | | | 24745FE | 2 | \$262.00 |
| Foam Cell Pro Strut - Performance | | | 45745FE | 2 | \$406.00 |

COIL SPRINGS

| | Est. Lift | Additional Load | | | |
|----------|-----------|-----------------|-----------------|---|----------|
| Standard | 0mm | 0 - 50kg | HOLD020S | 1 | \$262.00 |
| Light | 30mm | 0 - 50kg | HOLD020A | 1 | \$262.00 |
| Medium | 40mm | 0 - 50kg | HOLD020B | 1 | \$262.00 |
| Heavy | 40mm | 50 - 110kg | HOLD020C | 1 | \$262.00 |

STRUT MOUNTS

| | | | | | |
|-----------------|--|--|----------------|---|---------|
| Steel Strut Top | | | ISST017 | 2 | \$88.00 |
|-----------------|--|--|----------------|---|---------|

TRIM PACKERS

| | | | | |
|------------------------|-----------------------|-------------------------|---|---------|
| 5mm Strut Trim Packer | Nitro Gas / Foam Cell | HILFR05/HILFR05F | 2 | \$30.00 |
| 10mm Strut Trim Packer | Nitro Gas / Foam Cell | HILFR10/HILFR10F | 2 | \$30.00 |
| 15mm Strut Trim Packer | Nitro Gas / Foam Cell | HILFR15/HILFR15F | 2 | \$30.00 |

• ONLY Compatible with Ironman 4x4 Struts (except Pro), lift height subject to 2:1 motion ratio. Unnecessary fitment may lift vehicle too high

CONTROL ARMS

| | | | | | |
|------------------------------|--|--|------------------|---|----------|
| Pro-Forge Upper Control Arms | | | UCA041FAS | 1 | \$882.00 |
|------------------------------|--|--|------------------|---|----------|

REAR SUSPENSION

SHOCK ABSORBER

| | | | | | |
|-----------------------------|--|--|-----------------|---|----------|
| Nitro Gas - Comfort | | | 12746GRC | 2 | \$160.00 |
| Nitro Gas - Performance | | | 12746GR | 2 | \$160.00 |
| Foam Cell - Comfort | | | 24746FEC | 2 | \$232.00 |
| Foam Cell - Performance | | | 24746FE | 2 | \$232.00 |
| Foam Cell Pro - Comfort | | | 45746FEC | 2 | \$319.00 |
| Foam Cell Pro - Performance | | | 45746FE | 2 | \$319.00 |

COIL SPRINGS

| | Est. Lift | Additional Load | | | |
|----------|-----------|-----------------|-----------------|---|----------|
| Standard | 0mm | 0 - 250kg | HOLD022S | 1 | \$262.00 |
| Light | 30mm | 0 - 250kg | HOLD022A | 1 | \$262.00 |
| Medium | 40mm | 0 - 250kg | HOLD022B | 1 | \$262.00 |
| Heavy | 45mm | 250kg - GVM | HOLD022C | 1 | \$262.00 |

SUSPENSION KIT - Specify Front Coil Springs When Ordering

| | | |
|--------------------------|-------------------|-----------|
| Standard - Nitro Gas | HOLD022SKG | \$1304.00 |
| Standard - Foam Cell | HOLD022SKF | \$1506.00 |
| Standard - Foam Cell Pro | HOLD022SKP | \$1969.00 |
| Light - Nitro Gas | HOLD022AKG | \$1304.00 |
| Light - Foam Cell | HOLD022AKF | \$1506.00 |
| Light - Foam Cell Pro | HOLD022AKP | \$1969.00 |
| Medium - Nitro Gas | HOLD022BKG | \$1304.00 |
| Medium - Foam Cell | HOLD022BKF | \$1506.00 |
| Medium - Foam Cell Pro | HOLD022BKP | \$1969.00 |
| Heavy - Nitro Gas | HOLD022CKG | \$1304.00 |
| Heavy - Foam Cell | HOLD022CKF | \$1506.00 |
| Heavy - Foam Cell Pro | HOLD022CKP | \$1969.00 |

SUSPENSION KIT CONTENTS

Shock Absorbers

Strut Shock Absorbers

Coil Springs



Product Description

Part No.

Qty
ReqRetail
ea Inc GST

Please check vehicle date range (if shown) next to product description prior to ordering

ACCESSORIES TO SUIT GM / HOLDEN COLORADO - 11/2016-2020

STEEL WINCH BULL BARS

| | | |
|-------------------------------------|-----------|-----------|
| Commercial | BBC057 | \$1754.00 |
| Commercial Deluxe | BBCD057 | \$2387.00 |
| Proguard No Loop | BBT057-NL | \$1973.00 |
| Proguard Single Loop Kit | BB057-SL | \$352.00 |
| Proguard Triple Loop Kit | BB057-TL | \$423.00 |
| Driving Light / Lightbar Patch Loom | IPL057 | \$33.00 |

• Can also be fitted to both 2WD and 4WD models.

STEEL SIDE STEPS AND RAILS - FITS DUAL, SPACE AND SINGLE CAB MODELS ONLY

| | | |
|----------------------|------------|-----------|
| Side Steps | SS057 | \$1006.00 |
| Side Rails | SS057 RAIL | \$332.00 |
| Side Steps and Rails | SSR057 | \$1207.00 |

TOWING

| | | |
|---|-------------|-----------|
| Class 4 Towbar - Compatible with Factory Rear Bumper | TB040 | \$608.00 |
| Rear Protection Towbar - Full Rear Bumper Replacement | RTB040 | \$1388.00 |
| Rear Protection Towbar Plates (Pair) | RTBPLATE002 | \$153.00 |
| Towbar Wiring Loom - Plug and Play | ITBL040 | \$353.00 |
| Load Resistor Kit with Mounting Brackets for Licence Plate Lights | LR12V10W | \$59.00 |

RECOVERY POINTS - IRONMAN 4X4 BULL BAR ONLY

| | | |
|---|--------|----------|
| Recovery Points (One piece, two points) - 5000kg rating | IRP057 | \$396.00 |
| Recovery Points - 5000kg Rating (Pair) | IRP058 | \$323.00 |

BATTERY TRAY

| | | |
|------------------|-----------|----------|
| Suits 8" Battery | IBTRAY057 | \$156.00 |
|------------------|-----------|----------|

SNORKEL

| | | |
|-------------------|-------------|----------|
| Colorado RG 2016+ | ISNORKEL036 | \$437.00 |
|-------------------|-------------|----------|

LONG RANGE FUEL TANK

| | | |
|---|---------|-----------|
| 145L* Diesel only - Fits Dual Cab Automatic Transmission only | TANK057 | \$1180.00 |
|---|---------|-----------|

* Usable volume may differ to the stated tank capacity

PREMIUM UNDERBODY PROTECTION

| | | |
|-----------------------------|--------|----------|
| Engine Bay and Transmission | UBP057 | \$782.00 |
|-----------------------------|--------|----------|

LOCKSAFE DRAWER SYSTEMS

| | | |
|------------------------|---------|-----------|
| Twin Drawers - 1300mm | ITD1300 | \$1536.00 |
| Single Drawer - 1300mm | ISD1300 | \$932.00 |
| Wing Kit - 1300mm* | ITDW038 | \$367.00 |

* Designed to suit factory tubs, will not suit ute liner without modification

FENDER FLARE KITS

| | | |
|--|---------|----------|
| Matte Black Smooth Finish 6" (Suits Dual Cab Only) | IFF6057 | \$499.00 |
|--|---------|----------|

SEAT COVER

| | | |
|------------------------|----------|----------|
| Canvas Comfort - Front | ICSC040F | \$420.00 |
| Canvas Comfort - Rear | ICSC040R | \$420.00 |

BREATHER KIT

| | | |
|---|----------|----------|
| Universal Twin Manifold Filtered Breather Kit | IDIFFBRE | \$115.00 |
|---|----------|----------|



RG
2016 to 2020

GM / Holden Colorado

Product Description

Part No.

Qty
Req

Retail
ea Inc GST

Please check vehicle date range (if shown) next to product description prior to ordering

SUSPENSION TO SUIT GM / HOLDEN COLORADO - 2016-2020

FRONT SUSPENSION

SHOCK ABSORBER

| | | | | | |
|-----------------------------------|--|--|----------------|---|----------|
| Nitro Gas Strut - Performance | | | 12745GR | 2 | \$232.00 |
| Foam Cell Strut - Performance | | | 24745FE | 2 | \$262.00 |
| Foam Cell Pro Strut - Performance | | | 45745FE | 2 | \$406.00 |

COIL SPRINGS

| | Est. Lift | Additional Load | | | |
|--------|-----------|-----------------|-----------------|---|----------|
| Medium | 40mm | 0 - 50kg | HOLD020A | 1 | \$262.00 |
| Heavy | 40mm | 50 - 110kg | HOLD020B | 1 | \$262.00 |

STRUT MOUNTS

| | | | | | |
|-----------------|--|--|----------------|---|---------|
| Steel Strut Top | | | ISST017 | 2 | \$88.00 |
|-----------------|--|--|----------------|---|---------|

TRIM PACKERS

| | | | | | |
|------------------------|--|-----------------------|-------------------------|---|---------|
| 5mm Strut Trim Packer | | Nitro Gas / Foam Cell | HILFR05/HILFR05F | 2 | \$30.00 |
| 10mm Strut Trim Packer | | Nitro Gas / Foam Cell | HILFR10/HILFR10F | 2 | \$30.00 |
| 15mm Strut Trim Packer | | Nitro Gas / Foam Cell | HILFR15/HILFR15F | 2 | \$30.00 |

• ONLY Compatible with Ironman 4x4 Struts (except Pro), lift height subject to 2:1 motion ratio. Unnecessary fitment may lift vehicle too high

CONTROL ARMS

| | | | | | |
|------------------------------|--|--|-----------------|---|----------|
| Pro-Forge Upper Control Arms | | | UCA041FA | 1 | \$882.00 |
|------------------------------|--|--|-----------------|---|----------|

REAR SUSPENSION

SHOCK ABSORBER

| | | | | | |
|------------------------------|--|--|-----------------|---|----------|
| Nitro Gas - Comfort | | | 12636GRC | 2 | \$160.00 |
| Nitro Gas - Performance | | | 12636GR | 2 | \$160.00 |
| Nitro Gas - Professional | | | 12636GRP | 2 | \$160.00 |
| Foam Cell - Comfort | | | 24636FEC | 2 | \$232.00 |
| Foam Cell - Performance | | | 24636FE | 2 | \$232.00 |
| Foam Cell - Professional | | | 24636FEP | 2 | \$232.00 |
| Foam Cell Pro - Comfort | | | 45636FEC | 2 | \$319.00 |
| Foam Cell Pro - Performance | | | 45636FE | 2 | \$319.00 |
| Foam Cell Pro - Professional | | | 45636FEP | 2 | \$319.00 |

LEAF SPRINGS

| | Est. Lift | Additional Load | | | |
|-------------|-----------|-----------------|-----------------|---|----------|
| Light | 30mm | 0 - 200kg | HOLD021A | 2 | \$421.00 |
| Medium | 45mm | 0 - 300kg | HOLD021B | 2 | \$421.00 |
| Heavy | 45mm | 300kg - 600kg | HOLD021C | 2 | \$435.00 |
| Extra Heavy | 45mm | 600kg - GVM | HOLD021D | 2 | \$435.00 |

U-BOLTS

| | | | | | |
|------------|--|----------------|----------------|---|---------|
| U-Bolt Kit | | | 437UBKL | 2 | \$44.00 |
| U-Bolt Kit | | Suits HOLD021D | 678UBK | 2 | \$44.00 |

POLYURETHANE SPRING BUSHES

| | | | | | |
|----------|--|--|--------------|---|----------|
| Bush Kit | | | 770UK | 1 | \$175.00 |
|----------|--|--|--------------|---|----------|

GREASABLE SHACKLES AND PINS

| | | | | | |
|-------------------|--|--|--------------|---|---------|
| Greasable Shackle | | | 1148 | 2 | \$59.00 |
| Non-Greasable Pin | | | 387-1 | 2 | \$30.00 |

HELPER SPRINGS

| | | | | | |
|------------|--|--|----------------|---|----------|
| Add-A-Leaf | | | ISL6010 | 1 | \$175.00 |
|------------|--|--|----------------|---|----------|

LISTING
CONTINUED
OVER THE
PAGE

GM / Holden Colorado

RG
2016 to 2020



Product Description

Part No.

**Qty
Req**

**Retail
ea Inc GST**

Please check vehicle date range (if shown) next to product description prior to ordering

SUSPENSION KIT - Specify Front Coil Springs When Ordering

| | | |
|-----------------------------|--------------------|-----------|
| Light - Nitro Gas | HOLD021AKG1 | \$2157.00 |
| Light - Foam Cell | HOLD021AKF1 | \$2360.00 |
| Light - Foam Cell Pro | HOLD021AKP1 | \$2824.00 |
| Medium - Nitro Gas | HOLD021BKG1 | \$2157.00 |
| Medium - Foam Cell | HOLD021BKF1 | \$2360.00 |
| Medium - Foam Cell Pro | HOLD021BKP1 | \$2824.00 |
| Heavy - Nitro Gas | HOLD021CKG1 | \$2187.00 |
| Heavy - Foam Cell | HOLD021CKF1 | \$2389.00 |
| Heavy - Foam Cell Pro | HOLD021CKP1 | \$2852.00 |
| Extra Heavy - Nitro Gas | HOLD021DKG1 | \$2187.00 |
| Extra Heavy - Foam Cell | HOLD021DKF1 | \$2389.00 |
| Extra Heavy - Foam Cell Pro | HOLD021DKP1 | \$2852.00 |

SUSPENSION KIT CONTENTS

| | | |
|-----------------|--------------|----------------------------|
| Shock Absorbers | Coil Springs | Polyurethane Spring Bushes |
| Leaf Springs | U-Bolts | Strut Shock Absorbers |



OPTIONS AVAILABLE FOR THIS VEHICLE - SEE PAGE 380



RG
2012 to 10/2016

GM / Holden Colorado

| Product Description | Part No. | Qty Req | Retail ea Inc GST |
|--|-------------|------------|----------------------|
| ACCESSORIES TO SUIT GM / HOLDEN COLORADO - 2012-10/2016 | | | |
| STEEL WINCH BULL BARS | | | |
| Commercial | BBC040 | | \$1723.00 |
| Commercial Deluxe | BBCD040 | | \$2345.00 |
| Driving Light / Lightbar Patch Loom | IPL057 | | \$33.00 |
| • Can also be fitted to both 2WD and 4WD models. | | | |
| STEEL SIDE STEPS AND RAILS | | | |
| Side Steps | SS057 | | \$1006.00 |
| Side Rails | SS057 RAIL | | \$332.00 |
| Side Steps and Rails | SSR057 | | \$1207.00 |
| TOWING | | | |
| Class 4 Towbar - Compatible with Factory Rear Bumper | TB040 | | \$608.00 |
| Rear Protection Towbar - Full Rear Bumper Replacement | RTB040 | | \$1388.00 |
| Rear Protection Towbar Plates (Pair) | RTBPLATE002 | | \$153.00 |
| Towbar Wiring Loom - Plug and Play | ITBL040 | | \$353.00 |
| RECOVERY POINTS - IRONMAN 4X4 BULL BAR ONLY | | | |
| Recovery Points - 5000kg Rating (Pair) | IRP058 | | \$323.00 |
| SNORKEL | | | |
| Colorado RG 2012-10/2016 | ISNORKEL036 | | \$437.00 |
| LONG RANGE FUEL TANK | | | |
| 145L* Diesel only - Fits Dual Cab only | TANK057 | | \$1180.00 |
| * Usable volume may differ to the stated tank capacity | | | |
| PREMIUM UNDERBODY PROTECTION | | | |
| Engine Bay and Transmission | UBP041 | | \$782.00 |
| LOCKSAFE DRAWER SYSTEMS | | | |
| Twin Drawers - 1300mm | ITD1300 | | \$1536.00 |
| Single Drawer - 1300mm | ISD1300 | | \$932.00 |
| Wing Kit - 1300mm* | ITDW038 | | \$367.00 |
| *Designed to suit factory tubs, will not suit ute liner without modification | | | |
| FENDER FLARE KITS | | | |
| Matte Black Smooth Finish 6" (Suits Dual Cab Only) | IFF6040 | | \$499.00 |
| SEAT COVER | | | |
| Canvas Comfort - Front | ICSC040F | | \$420.00 |
| Canvas Comfort - Rear | ICSC040R | | \$420.00 |
| BREATHER KIT | | | |
| Universal Twin Manifold Filtered Breather Kit | IDIFFBRE | | \$115.00 |

LISTING
CONTINUED
OVER THE
PAGE





Product Description

Part No.

Qty
Req

Retail
ea Inc GST

Please check vehicle date range (if shown) next to product description prior to ordering

SUSPENSION TO SUIT GM / HOLDEN COLORADO - 2012-2016

FRONT SUSPENSION

SHOCK ABSORBER

| | | | | | |
|-----------------------------------|--|--|----------------|---|----------|
| Nitro Gas Strut - Performance | | | 12745GR | 2 | \$232.00 |
| Foam Cell Strut - Performance | | | 24745FE | 2 | \$262.00 |
| Foam Cell Pro Strut - Performance | | | 45745FE | 2 | \$406.00 |

COIL SPRINGS

| | Est. Lift | Additional Load | | | |
|----------|-----------|-----------------|-----------------|---|----------|
| Standard | 0mm | 0 - 50kg | HOLD020S | 1 | \$262.00 |
| Light | 30mm | 0 - 50kg | HOLD020A | 1 | \$262.00 |
| Medium | 40mm | 0 - 50kg | HOLD020B | 1 | \$262.00 |
| Heavy | 40mm | 50 - 110kg | HOLD020C | 1 | \$262.00 |

STRUT MOUNTS

| | | | | | |
|-----------------|--|--|----------------|---|---------|
| Steel Strut Top | | | ISST017 | 2 | \$88.00 |
|-----------------|--|--|----------------|---|---------|

TRIM PACKERS

| | | | | |
|------------------------|-----------------------|-------------------------|---|---------|
| 5mm Strut Trim Packer | Nitro Gas / Foam Cell | HILFR05/HILFR05F | 2 | \$30.00 |
| 10mm Strut Trim Packer | Nitro Gas / Foam Cell | HILFR10/HILFR10F | 2 | \$30.00 |
| 15mm Strut Trim Packer | Nitro Gas / Foam Cell | HILFR15/HILFR15F | 2 | \$30.00 |

• ONLY Compatible with Ironman 4x4 Struts (except Pro), lift height subject to 2:1 motion ratio. Unnecessary fitment may lift vehicle too high

CONTROL ARMS

| | | | | | |
|------------------------------|--|--|------------------|---|----------|
| Pro-Forge Upper Control Arms | | | UCA041FAS | 1 | \$882.00 |
|------------------------------|--|--|------------------|---|----------|

REAR SUSPENSION

SHOCK ABSORBER

| | | | | | |
|------------------------------|--|--|-----------------|---|----------|
| Nitro Gas - Comfort | | | 12636GRC | 2 | \$160.00 |
| Nitro Gas - Performance | | | 12636GR | 2 | \$160.00 |
| Nitro Gas - Professional | | | 12636GRP | 2 | \$160.00 |
| Foam Cell - Comfort | | | 24636FEC | 2 | \$232.00 |
| Foam Cell - Performance | | | 24636FE | 2 | \$232.00 |
| Foam Cell - Professional | | | 24636FEP | 2 | \$232.00 |
| Foam Cell Pro - Comfort | | | 45636FEC | 2 | \$319.00 |
| Foam Cell Pro - Performance | | | 45636FE | 2 | \$319.00 |
| Foam Cell Pro - Professional | | | 45636FEP | 2 | \$319.00 |

LEAF SPRINGS

| | Est. Lift | Additional Load | | | |
|-------------|-----------|-----------------|-----------------|---|----------|
| Light | 30mm | 0 - 200kg | HOLD021A | 2 | \$421.00 |
| Medium | 45mm | 0 - 300kg | HOLD021B | 2 | \$421.00 |
| Heavy | 45mm | 300kg - 600kg | HOLD021C | 2 | \$435.00 |
| Extra Heavy | 45mm | 600kg - GVM | HOLD021D | 2 | \$435.00 |

U-BOLTS

| | | | | | |
|------------|----------------|--|----------------|---|---------|
| U-Bolt Kit | | | 437UBKL | 2 | \$44.00 |
| U-Bolt Kit | Suits HOLD021D | | 678UBK | 2 | \$44.00 |

POLYURETHANE SPRING BUSHES

| | | | | | |
|----------|--|--|--------------|---|----------|
| Bush Kit | | | 770UK | 1 | \$175.00 |
|----------|--|--|--------------|---|----------|

GREASABLE SHACKLES AND PINS

| | | | | | |
|-------------------|--|--|--------------|---|---------|
| Greasable Shackle | | | 1148 | 2 | \$59.00 |
| Non-Greasable Pin | | | 387-1 | 2 | \$30.00 |

HELPER SPRINGS

| | | | | | |
|------------|--|--|----------------|---|----------|
| Add-A-Leaf | | | ISL6010 | 1 | \$175.00 |
|------------|--|--|----------------|---|----------|





RG
2012 to 2016

GM / Holden Colorado

Product Description

Part No.

**Qty
Req**

**Retail
ea Inc GST**

Please check vehicle date range (if shown) next to product description prior to ordering

SUSPENSION KIT - Specify Front Coil Springs When Ordering

| | | |
|-----------------------------|------------|-----------|
| Light - Nitro Gas | HOLD021AKG | \$2157.00 |
| Light - Foam Cell | HOLD021AKF | \$2360.00 |
| Light - Foam Cell Pro | HOLD021AKP | \$2824.00 |
| Medium - Nitro Gas | HOLD021BKG | \$2157.00 |
| Medium - Foam Cell | HOLD021BKF | \$2360.00 |
| Medium - Foam Cell Pro | HOLD021BKP | \$2824.00 |
| Heavy - Nitro Gas | HOLD021CKG | \$2187.00 |
| Heavy - Foam Cell | HOLD021CKF | \$2389.00 |
| Heavy - Foam Cell Pro | HOLD021CKP | \$2852.00 |
| Extra Heavy - Nitro Gas | HOLD021DKG | \$2187.00 |
| Extra Heavy - Foam Cell | HOLD021DKF | \$2389.00 |
| Extra Heavy - Foam Cell Pro | HOLD021DKP | \$2852.00 |

SUSPENSION KIT CONTENTS

| | | | |
|-----------------|--------------|----------------------------|-----------------------|
| Shock Absorbers | Coil Springs | Polyurethane Spring Bushes | Strut Shock Absorbers |
| Leaf Springs | U-Bolts | Brake Hose Relocation Kit | |



OPTIONS AVAILABLE FOR THIS VEHICLE - SEE PAGE 380





Product Description

Part No.

Qty
Req

Retail
ea Inc GST

Please check vehicle date range (if shown) next to product description prior to ordering

SUSPENSION TO SUIT GM / HOLDEN COLORADO - 2012+

FRONT SUSPENSION

SHOCK ABSORBER

Nitro Gas Strut - Performance **12797GR** 2 \$232.00

COIL SPRINGS

| | Est. Lift | Additional Load | | | |
|--------|-----------|-----------------|----------------|---|----------|
| Medium | 35mm | 0 - 50kg | TOY038B | 1 | \$262.00 |
| Heavy | 35mm | 50 - 110kg | TOY038C | 1 | \$262.00 |

TRIM PACKERS

| 5mm Strut Trim Packer | Nitro Gas / Foam Cell | HILFR05/HILFR05F | 2 | \$30.00 | |
|------------------------|-----------------------|-------------------------|---|---------|--|
| 10mm Strut Trim Packer | Nitro Gas / Foam Cell | HILFR10/HILFR10F | 2 | \$30.00 | |
| 15mm Strut Trim Packer | Nitro Gas / Foam Cell | HILFR15/HILFR15F | 2 | \$30.00 | |

• ONLY Compatible with Ironman 4x4 Struts (except Pro), lift height subject to 2:1 motion ratio. Unnecessary fitment may lift vehicle too high

REAR SUSPENSION

SHOCK ABSORBER

| | | | |
|--------------------------|-----------------|---|----------|
| Nitro Gas - Comfort | 12636GRC | 2 | \$160.00 |
| Nitro Gas - Performance | 12636GR | 2 | \$160.00 |
| Nitro Gas - Professional | 12636GRP | 2 | \$160.00 |
| Foam Cell - Comfort | 24636FEC | 2 | \$232.00 |
| Foam Cell - Performance | 24636FE | 2 | \$232.00 |
| Foam Cell - Professional | 24636FEP | 2 | \$232.00 |

LEAF SPRINGS

| | Est. Lift | Additional Load | | | |
|--------|-----------|-----------------|-----------------|---|----------|
| Medium | 45mm | 0 - 300kg | HOLD023B | 2 | \$392.00 |
| Heavy | 45mm | 300kg - 600kg | HOLD023C | 2 | \$421.00 |

U-BOLTS

U-Bolt Kit **417UBK** 2 \$44.00

POLYURETHANE SPRING BUSHES

Bush Kit **728UK** 1 \$88.00

GREASABLE SHACKLES AND PINS

Greasable Shackle **386-2** 2 \$59.00

HELPER SPRINGS

Add-A-Leaf **ISL6010** 1 \$175.00

SUSPENSION KIT - Specify Front Coil Springs When Ordering

| | | |
|--------------------|-------------------|-----------|
| Medium - Nitro Gas | HOLD023BKG | \$1999.00 |
| Heavy - Nitro Gas | HOLD023CKG | \$2056.00 |

SUSPENSION KIT CONTENTS

| | | |
|-----------------|--------------|----------------------------|
| Shock Absorbers | Coil Springs | Polyurethane Spring Bushes |
| Leaf Springs | U-Bolts | Strut Shock Absorbers |





RC
7/2008 to 12/2012

GM / Holden Colorado

Product Description

Part No.

Qty
Req

Retail
ea Inc GST

Please check vehicle date range (if shown) next to product description prior to ordering

ACCESSORIES TO SUIT GM / HOLDEN COLORADO - 7/2008-12/2012

STEEL WINCH BULL BARS

Commercial Deluxe

BBCD027

\$2345.00

Protector - *While Stocks Last*

BBT027

\$2271.00

• *Can also be fitted to both 2WD and 4WD models.*

STEEL SIDE STEPS AND RAILS - FITS DUAL CAB MODELS ONLY

Side Steps

SS001

\$1006.00

Side Steps and Rails

SSR006

\$1207.00

SNORKEL

Colorado RC 7/2008 to 12/2012

ISNORKEL028

\$437.00

UNDERBODY PROTECTION

Engine Bay and Transmission - *While Stocks Last*

\$563.00

LOCKSAFE DRAWER SYSTEMS

Twin Drawers - 1300mm

ITD1300

\$1536.00

Single Drawer - 1300mm

ISD1300

\$932.00

BREATHER KIT

Universal Twin Manifold Filtered Breather Kit

IDIFFBRE

\$115.00

LISTING
CONTINUED
OVER THE
PAGE



Product Description

Part No.

Qty
Req

Retail
ea Inc GST

Please check vehicle date range (if shown) next to product description prior to ordering

SUSPENSION TO SUIT GM / HOLDEN COLORADO - 2003-2012

FRONT SUSPENSION

SHOCK ABSORBER

| | | | |
|-------------------------|----------------|---|----------|
| Nitro Gas - Performance | 12667GR | 2 | \$160.00 |
| Foam Cell - Performance | 24667FE | 2 | \$232.00 |

TORSION BAR

| | | | |
|-----------------------|----------------|---|----------|
| Up-rated Torsion Bars | HOLD010 | 1 | \$435.00 |
|-----------------------|----------------|---|----------|

• Minimum 60mm downward suspension travel required after adjustment

REAR SUSPENSION

SHOCK ABSORBER

| | | | |
|--------------------------|-----------------|---|----------|
| Nitro Gas - Comfort | 12636GRC | 2 | \$160.00 |
| Nitro Gas - Performance | 12636GR | 2 | \$160.00 |
| Nitro Gas - Professional | 12636GRP | 2 | \$160.00 |
| Foam Cell - Comfort | 24636FEC | 2 | \$232.00 |
| Foam Cell - Performance | 24636FE | 2 | \$232.00 |
| Foam Cell - Professional | 24636FEP | 2 | \$232.00 |

LEAF SPRINGS

| | Est. Lift | Additional Load | | | |
|-------------|-----------|-----------------|-----------------|---|----------|
| Medium | 40mm | 0 - 300kg | HOLD006B | 2 | \$392.00 |
| Heavy | 40mm | 300kg - 600kg | HOLD006C | 2 | \$421.00 |
| Extra Heavy | 40mm | 600 kg - GVM | HOLD006D | 2 | \$421.00 |

U-BOLTS

| | | | |
|------------|---------------|---|---------|
| U-Bolt Kit | 417UBK | 2 | \$44.00 |
|------------|---------------|---|---------|

POLYURETHANE SPRING BUSHES

| | | | |
|----------|---------------|---|---------|
| Bush Kit | 728TUK | 1 | \$88.00 |
|----------|---------------|---|---------|

GREASABLE SHACKLES AND PINS

| | | | |
|-------------------|--------------|---|---------|
| Greasable Shackle | 386-2 | 2 | \$59.00 |
| Non-Greasable Pin | 387-1 | 2 | \$30.00 |

HELPER SPRINGS

| | | | |
|------------|----------------|---|----------|
| Add-A-Leaf | ISL6010 | 1 | \$175.00 |
|------------|----------------|---|----------|

• Load Plus not suitable for Rodeo / Colorado / D-Max with OEM springs due to interleaf liners

SUSPENSION KIT

| | | |
|-------------------------|-------------------|-----------|
| Medium - Nitro Gas | HOLD006BKG | \$2028.00 |
| Medium - Foam Cell | HOLD006BKF | \$2317.00 |
| Heavy - Nitro Gas | HOLD006CKG | \$2085.00 |
| Heavy - Foam Cell | HOLD006CKF | \$2375.00 |
| Extra Heavy - Nitro Gas | HOLD006DKG | \$2085.00 |
| Extra Heavy - Foam Cell | HOLD006DKF | \$2375.00 |

SUSPENSION KIT CONTENTS

| | | |
|-----------------|--------------|----------------------------|
| Shock Absorbers | Torsion Bars | Polyurethane Spring Bushes |
| Leaf Springs | U-Bolts | |





RA7
2007 to 7/2008

GM / Holden Rodeo

Product Description

Part No.

Qty
Req

Retail
ea Inc GST

Please check vehicle date range (if shown) next to product description prior to ordering

ACCESSORIES TO SUIT GM / HOLDEN RODEO - 2007-7/2008

STEEL WINCH BULL BARS

Commercial Deluxe

BBCD020

\$2345.00

• Can also be fitted to both 2WD and 4WD models.

STEEL SIDE STEPS AND RAILS - FITS DUAL CAB MODELS ONLY

Side Steps

SS001

\$1006.00

Side Steps and Rails

SSR006

\$1207.00

SNORKEL

LX and LT (Does not fit DX model)

ISNORKEL022

\$437.00

UNDERBODY PROTECTION

Engine Bay and Transmission - *While Stocks Last*

IUP009K

\$563.00

LOCKSAFE DRAWER SYSTEMS

Twin Drawers - 1300mm

ITD1300

\$1536.00

Single Drawer - 1300mm

ISD1300

\$932.00

BREATHER KIT

Universal Twin Manifold Filtered Breather Kit

IDIFFBRE

\$115.00

LISTING
CONTINUED
OVER THE
PAGE



Product Description

Part No.

**Qty
Req**

**Retail
ea Inc GST**

Please check vehicle date range (if shown) next to product description prior to ordering

SUSPENSION TO SUIT GM / HOLDEN RODEO - 2003-2012

FRONT SUSPENSION

SHOCK ABSORBER

| | | | |
|-------------------------|----------------|---|----------|
| Nitro Gas - Performance | 12667GR | 2 | \$160.00 |
| Foam Cell - Performance | 24667FE | 2 | \$232.00 |

TORSION BAR

| | | | |
|-----------------------|----------------|---|----------|
| Up-rated Torsion Bars | HOLD010 | 1 | \$435.00 |
|-----------------------|----------------|---|----------|

• Minimum 60mm downward suspension travel required after adjustment

REAR SUSPENSION

SHOCK ABSORBER

| | | | |
|--------------------------|-----------------|---|----------|
| Nitro Gas - Comfort | 12636GRC | 2 | \$160.00 |
| Nitro Gas - Performance | 12636GR | 2 | \$160.00 |
| Nitro Gas - Professional | 12636GRP | 2 | \$160.00 |
| Foam Cell - Comfort | 24636FEC | 2 | \$232.00 |
| Foam Cell - Performance | 24636FE | 2 | \$232.00 |
| Foam Cell - Professional | 24636FEP | 2 | \$232.00 |

LEAF SPRINGS

| | Est. Lift | Additional Load | | | |
|-------------|-----------|-----------------|-----------------|---|----------|
| Medium | 40mm | 0 - 300kg | HOLD006B | 2 | \$392.00 |
| Heavy | 40mm | 300kg - 600kg | HOLD006C | 2 | \$421.00 |
| Extra Heavy | 40mm | 600 kg - GVM | HOLD006D | 2 | \$421.00 |

U-BOLTS

| | | | |
|------------|---------------|---|---------|
| U-Bolt Kit | 417UBK | 2 | \$44.00 |
|------------|---------------|---|---------|

POLYURETHANE SPRING BUSHES

| | | | |
|----------|---------------|---|---------|
| Bush Kit | 728TUK | 1 | \$88.00 |
|----------|---------------|---|---------|

GREASABLE SHACKLES AND PINS

| | | | |
|-------------------|--------------|---|---------|
| Greasable Shackle | 386-2 | 2 | \$59.00 |
| Non-Greasable Pin | 387-1 | 2 | \$30.00 |

HELPER SPRINGS

| | | | |
|------------|----------------|---|----------|
| Add-A-Leaf | ISL6010 | 1 | \$175.00 |
|------------|----------------|---|----------|

• Load Plus not suitable for Rodeo / Colorado / D-Max with OEM springs due to interleaf liners

SUSPENSION KIT

| | | |
|-------------------------|-------------------|-----------|
| Medium - Nitro Gas | HOLD006BKG | \$2028.00 |
| Medium - Foam Cell | HOLD006BKF | \$2317.00 |
| Heavy - Nitro Gas | HOLD006CKG | \$2085.00 |
| Heavy - Foam Cell | HOLD006CKF | \$2375.00 |
| Extra Heavy - Nitro Gas | HOLD006DKG | \$2085.00 |
| Extra Heavy - Foam Cell | HOLD006DKF | \$2375.00 |

SUSPENSION KIT CONTENTS

| | | |
|-----------------|--------------|----------------------------|
| Shock Absorbers | Torsion Bars | Polyurethane Spring Bushes |
| Leaf Springs | U-Bolts | |





RA
2002 to 2006

GM / Holden Rodeo

Product Description

Part No.

Qty
Req

Retail
ea Inc GST

Please check vehicle date range (if shown) next to product description prior to ordering

ACCESSORIES TO SUIT GM / HOLDEN RODEO - 2002-2006

STEEL WINCH BULL BARS

Commercial Deluxe

BBCD003

\$2345.00

• Can also be fitted to both 2WD and 4WD models.

STEEL SIDE STEPS AND RAILS - FITS DUAL CAB MODELS ONLY

Side Steps

SS001

\$1006.00

Side Steps and Rails

SSR006

\$1207.00

UNDERBODY PROTECTION

Engine Bay and Transmission - *While Stocks Last*

IUP009K

\$563.00

LOCKSAFE DRAWER SYSTEMS

Twin Drawers - 1300mm

ITD1300

\$1536.00

Single Drawer - 1300mm

ISD1300

\$932.00

BREATHER KIT

Universal Twin Manifold Filtered Breather Kit

IDIFFBRE

\$115.00



Product Description

Part No.

Qty
Req

Retail
ea Inc GST

Please check vehicle date range (if shown) next to product description prior to ordering

SUSPENSION TO SUIT GM / HOLDEN RODEO - 1988-3/2003

FRONT SUSPENSION

SHOCK ABSORBER

Nitro Gas - Performance **12643GR** 2 \$160.00

TORSION BAR

Up-rated Torsion Bars **HOLD005A** 1 \$435.00

• Minimum 60mm downward suspension travel required after adjustment

REAR SUSPENSION

SHOCK ABSORBER

Nitro Gas - Comfort **12636GRC** 2 \$160.00

Nitro Gas - Performance **12636GR** 2 \$160.00

Nitro Gas - Professional **12636GRP** 2 \$160.00

Foam Cell - Comfort **24636FEC** 2 \$232.00

Foam Cell - Performance **24636FE** 2 \$232.00

Foam Cell - Professional **24636FEP** 2 \$232.00

LEAF SPRINGS

| | | | | | |
|-----------------------|-----------|-----------------|--------------------|---|----------|
| | Est. Lift | Additional Load | | | |
| Medium - Drivers Side | 40mm | 0 - 300kg | HOLD004BD/S | 1 | \$392.00 |
| Medium - Near Side | 40mm | 0 - 300kg | HOLD004BN/S | 1 | \$392.00 |
| Heavy - Drivers Side | 40mm | 300kg - GVM | HOLD004CD/S | 1 | \$421.00 |
| Heavy - Near Side | 40mm | 300kg - GVM | HOLD004CN/S | 1 | \$421.00 |

SUSPENSION KIT

Medium - Nitro Gas **HOLD004BKG2** \$2028.00

Heavy - Nitro Gas **HOLD004CKG2** \$2085.00

SUSPENSION KIT CONTENTS

Shock Absorbers

Torsion Bars

Polyurethane Spring Bushes

Leaf Springs

U-Bolts





KB - TF
1983 to 1988

GM / Holden Rodeo

Product Description

Part No.

Qty
Req

Retail
ea Inc GST

Please check vehicle date range (if shown) next to product description prior to ordering

SUSPENSION TO SUIT GM / HOLDEN RODEO - 1983-1988

FRONT SUSPENSION

SHOCK ABSORBER

| | | | | |
|-------------------------|--|----------------|---|----------|
| Nitro Gas - Performance | | 12087GR | 2 | \$160.00 |
| Foam Cell - Performance | | 24087FE | 2 | \$232.00 |

TORSION BAR

| | | | | |
|----------------------|-------------------|-----------------|---|----------|
| Uprated Torsion Bars | Suits 1983 - 1988 | MAZDA005 | 1 | \$435.00 |
|----------------------|-------------------|-----------------|---|----------|

• Minimum 60mm downward suspension travel required after adjustment

REAR SUSPENSION

SHOCK ABSORBER

| | | | | |
|--------------------------|--|-----------------|---|----------|
| Nitro Gas - Comfort | | 12636GRC | 2 | \$160.00 |
| Nitro Gas - Performance | | 12636GR | 2 | \$160.00 |
| Nitro Gas - Professional | | 12636GRP | 2 | \$160.00 |
| Foam Cell - Comfort | | 24636FEC | 2 | \$232.00 |
| Foam Cell - Performance | | 24636FE | 2 | \$232.00 |
| Foam Cell - Professional | | 24636FEP | 2 | \$232.00 |

LEAF SPRINGS

| | Est. Lift | Additional Load | | | |
|-----------------------|-----------|-----------------|--------------------|---|----------|
| Medium - Drivers Side | 40mm | 0 - 300kg | HOLD004BD/S | 1 | \$392.00 |
| Medium - Near Side | 40mm | 0 - 300kg | HOLD004BN/S | 1 | \$392.00 |
| Heavy - Drivers Side | 40mm | 300kg - GVM | HOLD004CD/S | 1 | \$421.00 |
| Heavy - Near Side | 40mm | 300kg - GVM | HOLD004CN/S | 1 | \$421.00 |

U-BOLTS

| | | | | |
|------------|--|---------------|---|---------|
| U-Bolt Kit | | 451UBK | 2 | \$44.00 |
|------------|--|---------------|---|---------|

POLYURETHANE SPRING BUSHES

| | | | | |
|----------|--|--------------|---|---------|
| Bush Kit | | 728UK | 1 | \$88.00 |
|----------|--|--------------|---|---------|

GREASABLE SHACKLES AND PINS

| | | | | |
|-------------------|--|------------|---|---------|
| Greasable Shackle | | 791 | 2 | \$59.00 |
| Greasable Pin | | 792 | 2 | \$44.00 |

HELPER SPRINGS

| | | | | |
|--------------------------|--|----------------|---|----------|
| Load Plus Helper Springs | | LP3 | 1 | \$165.00 |
| Add-A-Leaf | | ISL6010 | 1 | \$175.00 |

SUSPENSION KIT

| | | | | |
|--------------------|--|--------------------|--|-----------|
| Medium - Nitro Gas | | HOLD004BKG1 | | \$2028.00 |
| Medium - Foam Cell | | HOLD004BKF1 | | \$2317.00 |
| Heavy - Nitro Gas | | HOLD004CKG1 | | \$2085.00 |
| Heavy - Foam Cell | | HOLD004CKF1 | | \$2375.00 |

SUSPENSION KIT CONTENTS

| | | |
|-----------------|--------------|----------------------------|
| Shock Absorbers | Torsion Bars | Polyurethane Spring Bushes |
| Leaf Springs | U-Bolts | |

Great Wall Ute

Cannon
9/2020+



Product Description

DATE AVAILABLE

Part No.

Qty
Req

Retail
ea Inc GST

Please check vehicle date range (if shown) next to product description prior to ordering

ACCESSORIES TO SUIT GREAT WALL UTE - 9/2020+

STEEL WINCH BULL BARS

| | | | |
|-------------------|---------|---------|-----------|
| Commercial Deluxe | Q4 2022 | BBCD083 | \$2387.00 |
|-------------------|---------|---------|-----------|

STEEL SIDE STEPS AND RAILS

| | | | |
|------------|---------|-------|----------|
| Side Steps | Q2 2023 | SS083 | \$962.00 |
|------------|---------|-------|----------|

| | | | |
|------------|---------|------------|----------|
| Side Rails | Q2 2023 | SS083 RAIL | \$317.00 |
|------------|---------|------------|----------|

| | | | |
|----------------------|---------|--------|-----------|
| Side Steps and Rails | Q2 2023 | SSR083 | \$1155.00 |
|----------------------|---------|--------|-----------|

TOWING

| | | | |
|---|---------|--------|-----------|
| Rear Protection Towbar - Full Rear Bumper Replacement | Q2 2023 | RTB083 | \$1388.00 |
|---|---------|--------|-----------|

| | | | |
|------------------------------------|---------|---------|----------|
| Towbar Wiring Loom - Plug and Play | Q2 2023 | ITBL083 | \$337.00 |
|------------------------------------|---------|---------|----------|

SLIDE-AWAY ROLL UP HARD TONNEAU COVER

| | | | |
|------------------------------|--|-----------------|-----------|
| Electric with Remote Control | | ISLIDEAWAY083-E | \$2716.00 |
|------------------------------|--|-----------------|-----------|

ATLAS ROOF RACK KITS

| | | | |
|--|--|---------------|-----------|
| Platform S with Blade Fit Kit to Suit Slideaway Hard Tonneau Cover - 1390mm Length | | IFRSLDAWAYPSK | \$1670.00 |
|--|--|---------------|-----------|

| | | | |
|--|--|---------------|----------|
| Crossbar (x 2) and Fit Kit to Suit Slideaway Hard Tonneau Cover - 1500mm Width | | IFRSLDAWAYC2K | \$940.00 |
|--|--|---------------|----------|

• See Page 36 and 37 for more Atlas rack and crossbar options.

BREATHER KIT

| | | | |
|---|--|----------|----------|
| Universal Twin Manifold Filtered Breather Kit | | IDIFFBRE | \$115.00 |
|---|--|----------|----------|



Great Wall Ute

Cannon
9/2020+

Product Description

Part No.

Qty
ReqRetail
ea Inc GST*Please check vehicle date range (if shown) next to product description prior to ordering***SUSPENSION TO SUIT GREAT WALL UTE - 9/2020+****FRONT SUSPENSION****SHOCK ABSORBER**

| | | | | | |
|-----------------------------------|--|--|----------------|---|----------|
| Nitro Gas Strut - Performance | | | 12853GR | 2 | \$232.00 |
| Foam Cell Strut - Performance | | | 24853FE | 2 | \$262.00 |
| Foam Cell Pro Strut - Performance | | | 45853FE | 2 | \$406.00 |

COIL SPRINGS

| | Est. Lift | Additional Load | | | |
|----------|-----------|-----------------|----------------|---|----------|
| Standard | 10mm | 0 - 50kg | TOY055A | 1 | \$262.00 |
| Light | 50mm | 0 - 50kg | TOY055B | 1 | \$262.00 |
| Medium | 50mm | 50 - 110kg | TOY055C | 1 | \$262.00 |

STRUT MOUNTS

| | | | | | |
|-----------------|--|--|----------------|---|----------|
| Steel Strut Top | | | ISST083 | 2 | \$102.00 |
|-----------------|--|--|----------------|---|----------|

TRIM PACKERS

| | | | | |
|------------------------|-----------------------|-------------------------|---|---------|
| 5mm Strut Trim Packer | Nitro Gas / Foam Cell | HILFR05/HILFR05F | 2 | \$30.00 |
| 10mm Strut Trim Packer | Nitro Gas / Foam Cell | HILFR10/HILFR10F | 2 | \$30.00 |
| 15mm Strut Trim Packer | Nitro Gas / Foam Cell | HILFR15/HILFR15F | 2 | \$30.00 |

• ONLY Compatible with Ironman 4x4 Struts (except Pro), lift height subject to 2:1 motion ratio. Unnecessary fitment may lift vehicle too high

CONTROL ARMS

| | | | | | |
|------------------------------|--|--|------------------|---|----------|
| Pro-Forge Upper Control Arms | | | UCA001FAS | 1 | \$882.00 |
|------------------------------|--|--|------------------|---|----------|

REAR SUSPENSION**SHOCK ABSORBER**

| | | | | | |
|------------------------------|--|--|-----------------|---|----------|
| Nitro Gas - Comfort | | | 12095GRC | 2 | \$160.00 |
| Nitro Gas - Performance | | | 12095GR | 2 | \$160.00 |
| Foam Cell - Comfort | | | 24095FEC | 2 | \$232.00 |
| Foam Cell - Performance | | | 24095FE | 2 | \$232.00 |
| Foam Cell - Professional | | | 24095FEP | 2 | \$232.00 |
| Foam Cell Pro - Comfort | | | 45095FEC | 2 | \$319.00 |
| Foam Cell Pro - Performance | | | 45095FE | 2 | \$319.00 |
| Foam Cell Pro - Professional | | | 45095FEP | 2 | \$319.00 |

LEAF SPRINGS

| | Est. Lift | Additional Load | | | |
|--------|-----------|-----------------|----------------|---|----------|
| Light | 40mm | 0 - 200kg | FOR002A | 2 | \$392.00 |
| Medium | 50mm | 0 - 300kg | FOR002B | 2 | \$392.00 |
| Heavy | 50mm | 300kg - GVM | FOR002C | 2 | \$421.00 |

• Possible driveline vibration may occur due to increased ride height, use 1217K to reduce vibration to satisfactory level

U-BOLTS

| | | | | | |
|------------|--|--|----------------|---|---------|
| U-Bolt Kit | | | 1107UBK | 2 | \$44.00 |
|------------|--|--|----------------|---|---------|

POLYURETHANE SPRING BUSHES

| | | | | | |
|----------|--|--|---------------|---|----------|
| Bush Kit | | | 1195UK | 1 | \$183.00 |
|----------|--|--|---------------|---|----------|

DRIVELINE SPACERS

| | | | | | |
|---------------------------|--|--|--------------|---|---------|
| Centre Bearing Spacer Kit | | | 1217K | 1 | \$30.00 |
|---------------------------|--|--|--------------|---|---------|

GREASABLE SHACKLES AND PINS

| | | | | | |
|-------------------|--|--|--------------|---|---------|
| Greasable Shackle | | | 1147 | 2 | \$59.00 |
| Non-Greasable Pin | | | 387-1 | 2 | \$30.00 |

HELPER SPRINGS

| | | | | | |
|--------------------------|--|--|----------------|---|----------|
| Load Plus Helper Springs | | | LP3 | 1 | \$165.00 |
| Add-A-Leaf | | | ISL6010 | 1 | \$175.00 |

SUSPENSION KIT - Specify Front Coil Springs When Ordering

| | | |
|------------------------|------------------|-----------|
| Light - Nitro Gas | GWM002AKG | \$2115.00 |
| Light - Foam Cell | GWM002AKF | \$2317.00 |
| Light - Foam Cell Pro | GWM002AKP | \$2780.00 |
| Medium - Nitro Gas | GWM002BKG | \$2115.00 |
| Medium - Foam Cell | GWM002BKF | \$2317.00 |
| Medium - Foam Cell Pro | GWM002BKP | \$2780.00 |
| Heavy - Nitro Gas | GWM002CKG | \$2172.00 |
| Heavy - Foam Cell | GWM002CKF | \$2375.00 |
| Heavy - Foam Cell Pro | GWM002CKP | \$2839.00 |

• Possible driveline vibration may occur due to increased ride height, use 1217K to reduce vibration to satisfactory level

SUSPENSION KIT CONTENTS

| | | | |
|-----------------------|--------------|----------------------------|---------------------------|
| Shock Absorbers | Coil Springs | U-Bolts | Centre Bearing Spacer Kit |
| Strut Shock Absorbers | Leaf Springs | Polyurethane Spring Bushes | |

Haval H9

Wagon 2.0L Petrol
8/2017+



Product Description

Part No.

Qty
Req

Retail
ea Inc GST

Please check vehicle date range (if shown) next to product description prior to ordering

SUSPENSION TO SUIT HAVAL H9 - 8/2017+

FRONT SUSPENSION

SHOCK ABSORBER

| | | | | | |
|-------------------------------|--|--|----------------|---|----------|
| Nitro Gas Strut - Performance | | | 12710GR | 2 | \$232.00 |
| Foam Cell Strut - Performance | | | 24710FE | 2 | \$262.00 |

COIL SPRINGS

| | Est. Lift | Additional Load | | | |
|--------|-----------|-----------------|----------------|---|----------|
| Medium | 40mm | 0 - 50kg | TOY055C | 1 | \$262.00 |
| Heavy | 40mm | 50 - 110kg | TOY065B | 1 | \$262.00 |

STRUT MOUNTS

| | | | | | |
|-----------------|--|--|----------------|---|---------|
| Steel Strut Top | | | ISST001 | 2 | \$88.00 |
|-----------------|--|--|----------------|---|---------|

TRIM PACKERS

| | | | | | |
|------------------------|--|-----------------------|-------------------------|---|---------|
| 5mm Strut Trim Packer | | Nitro Gas / Foam Cell | HILFR05/HILFR05F | 2 | \$30.00 |
| 10mm Strut Trim Packer | | Nitro Gas / Foam Cell | HILFR10/HILFR10F | 2 | \$30.00 |
| 15mm Strut Trim Packer | | Nitro Gas / Foam Cell | HILFR15/HILFR15F | 2 | \$30.00 |

• ONLY Compatible with Ironman 4x4 Struts (except Pro), lift height subject to 2:1 motion ratio. Unnecessary fitment may lift vehicle too high

REAR SUSPENSION

SHOCK ABSORBER

| | | | | | |
|-------------------------|--|--|----------------|---|----------|
| Nitro Gas - Performance | | | 12804GR | 2 | \$160.00 |
| Foam Cell - Performance | | | 24804FE | 2 | \$232.00 |

COIL SPRINGS

| | Est. Lift | Additional Load | | | |
|-------------|-----------|-----------------|----------------|---|----------|
| Medium | 40mm | 0 - 200kg | TOY056A | 1 | \$262.00 |
| Heavy | 40mm | 200 - 400kg | TOY056B | 1 | \$262.00 |
| Extra Heavy | 40mm | 400kg - GVM | TOY056C | 1 | \$262.00 |

SUSPENSION KIT - Specify Front Coil Springs When Ordering

| | | |
|-------------------------|------------------|-----------|
| Medium - Nitro Gas | TOY056AKG | \$1304.00 |
| Medium - Foam Cell | TOY056AKF | \$1506.00 |
| Heavy - Nitro Gas | TOY056BKG | \$1304.00 |
| Heavy - Foam Cell | TOY056BKF | \$1506.00 |
| Extra Heavy - Nitro Gas | TOY056CKG | \$1304.00 |
| Extra Heavy - Foam Cell | TOY056CKF | \$1506.00 |

SUSPENSION KIT CONTENTS

Shock Absorbers Strut Shock Absorbers Coil Springs



Hyundai iLoad

2016+



Product Description

Part No.

Qty
Req

Retail
ea Inc GST

Please check vehicle date range (if shown) next to product description prior to ordering

ACCESSORIES TO SUIT HYUNDAI ILOAD - 2016+

SEAT COVER

Canvas Comfort - Front Bucket and 3/4 Bench (Suits TQ3-V Series II)

ICSCIOLOAD

\$420.00

SUSPENSION TO SUIT

Hyundai Terracan

2001+



Product Description

Part No.

Qty
Req

Retail
ea Inc GST

Please check vehicle date range (if shown) next to product description prior to ordering

SUSPENSION TO SUIT HYUNDAI TERRACAN - 2001+

FRONT SUSPENSION

SHOCK ABSORBER

Nitro Gas - Performance

12087GR

2

\$160.00

Foam Cell - Performance

24087FE

2

\$232.00

TORSION BAR

Uprated Torsion Bars

HYUND004

1

\$493.00

• Minimum 60mm downward suspension travel required after adjustment

REAR SUSPENSION

SHOCK ABSORBER

Nitro Gas - Comfort

12637GRC

2

\$160.00

Nitro Gas - Performance

12637GR

2

\$160.00

COIL SPRINGS

Medium

Est. Lift
40mm

Additional Load
0 - 300kg

HYUND003B

1

\$262.00

DIFF BREATHER EXTENDED

Breather Hose

DHOSE350

1

\$7.00

SUSPENSION KIT

Medium - Nitro Gas

HYUND003BKG

\$1397.00

SUSPENSION KIT CONTENTS

Shock Absorbers

Torsion Bar

Coil Springs

Extended Breather Hose



Product Description

Part No.

Qty
Req

Retail
ea Inc GST

Please check vehicle date range (if shown) next to product description prior to ordering

ACCESSORIES TO SUIT ISUZU D-MAX - 8/2019+

STEEL WINCH BULL BARS

| | | |
|---|-----------|-----------|
| Commercial | BBC074 | \$1754.00 |
| Commercial Deluxe | BBCD074 | \$2387.00 |
| Proguard No Loop | BBT074-NL | \$1973.00 |
| Proguard Single Loop Kit | BB074-SL | \$352.00 |
| Proguard Triple Loop Kit | BB074-TL | \$423.00 |
| Driving Light / Lightbar Patch Loom - Factory LED Headlight models only | IPL074 | \$33.00 |
| Load Resistor Kit with Mounting Brackets for Indicator / Parker Replacement | LR12V21W | \$52.00 |

• Winch with Steel Cable and Roller Fairlead is not suitable - Use Winch with Synthetic Rope and Alloy Hawse only

STEEL SIDE STEPS AND RAILS

| | | |
|---|------------|-----------|
| Side Steps (Suits Dual and Single Cab Only) | SS074 | \$1006.00 |
| Side Rails | SS074 RAIL | \$332.00 |
| Side Steps and Rails (Suits Dual and Single Cab Only) | SSR074 | \$1207.00 |

TOWING

| | | |
|------------------------------------|---------|-----------|
| Rear Protection Towbar | RTB074 | \$1388.00 |
| Towbar Wiring Loom - Plug and Play | ITBL074 | \$466.00 |

RECOVERY POINTS - IRONMAN 4X4 BULL BAR ONLY

| | | |
|------------------------|--------|----------|
| Recovery Points (Pair) | IRP074 | \$227.00 |
|------------------------|--------|----------|

SNORKEL

| | | |
|---------------|-------------|----------|
| D-Max 8/2019+ | ISNORKEL074 | \$437.00 |
|---------------|-------------|----------|

PREMIUM UNDERBODY PROTECTION

| | | |
|---|---------|----------|
| Engine Bay and Transmission - Electric Steering Model | UBP074S | \$745.00 |
| Engine Bay and Transmission - Non-Electric Steering Model | UBP074 | \$745.00 |

LOCKSAFE DRAWER SYSTEMS

| | | |
|------------------------|---------|-----------|
| Twin Drawers - 1300mm | ITD1300 | \$1536.00 |
| Single Drawer - 1300mm | ISD1300 | \$932.00 |
| Wing Kit - 1300mm* | ITDW074 | \$367.00 |

*Designed to suit factory tubs, will not suit ute liner without modification

CANOPY - PINNACLE 2 FIBREGLASS (SIDE LIFT UP WINDOWS AND CENTRAL LOCKING REAR DOOR) - FITS 4X4 AND 4X2 DUAL CAB MODELS

| | | |
|----------------------|---------------|-----------|
| Pre-Primed | ICANOPY074-P | \$3213.00 |
| Basalt Black (569) | ICANOPY074-B | \$3763.00 |
| Galena Grey (563) | ICANOPY074-GG | \$3763.00 |
| Obsidian Grey (554) | ICANOPY074-OG | \$3763.00 |
| Mercury Silver (568) | ICANOPY074-S | \$3763.00 |
| Marble White (527) | ICANOPY074-W | \$3763.00 |

* Pre-primed canopies, plus colour coding.

SLIDE-AWAY ROLL UP HARD TONNEAU COVER

| | | |
|------------------------------|-----------------|-----------|
| Electric with Remote Control | ISLIDEAWAY074-E | \$2716.00 |
|------------------------------|-----------------|-----------|

ATLAS DUAL CAB ROOF RACK KITS

| | | |
|--|---------------|-----------|
| Platform A with Blade Fit Kit (Dual Cab Only) - 1530mm Length | IFR074PAK | \$1608.00 |
| Crossbar (x 2) and Fit Kit (Dual Cab) - 1250mm Width | IFR074C2K | \$514.00 |
| Platform K with Leg Fit Kit to Suit Pinnacle 2 Canopy - 1390mm Length | IFRP2PKK | \$1294.00 |
| Crossbar (x 2) and Fit Kit to Suit Pinnacle 2 Canopy - 1250mm Width | IFRP2C125K | \$564.00 |
| Platform S with Blade Fit Kit to Suit Slideaway Hard Tonneau Cover - 1390mm Length | IFRSLDAWAYPSK | \$1670.00 |
| Crossbar (x 2) and Fit Kit to Suit Slideaway Hard Tonneau Cover - 1500mm Width | IFRSLDAWAYC2K | \$940.00 |

• See Page 36 and 37 for more Atlas rack and crossbar options.

FENDER FLARE KITS

| | | |
|--|---------|----------|
| Matte Black Smooth Finish V-Cross 6" (Suits Dual Cab Only) | IFF6074 | \$499.00 |
|--|---------|----------|

SEAT COVER

| | | |
|------------------------|----------|----------|
| Canvas Comfort - Front | ICSC074F | \$420.00 |
| Canvas Comfort - Rear | ICSC074R | \$420.00 |

BREATHER KIT

| | | |
|---|----------|----------|
| Universal Twin Manifold Filtered Breather Kit | IDIFFBRE | \$115.00 |
|---|----------|----------|



Isuzu D-Max

8/2019+

Product Description

Part No.

Qty
ReqRetail
ea Inc GST*Please check vehicle date range (if shown) next to product description prior to ordering***SUSPENSION TO SUIT ISUZU D-MAX - 8/2019+****FRONT SUSPENSION****SHOCK ABSORBER**

| | | | | | |
|-----------------------------------|--|--|----------------|---|----------|
| Nitro Gas Strut - Performance | | | 12845GR | 2 | \$232.00 |
| Foam Cell Strut - Performance | | | 24845FE | 2 | \$262.00 |
| Foam Cell Pro Strut - Performance | | | 45845FE | 2 | \$406.00 |

COIL SPRINGS

| | Est. Lift | Additional Load | | | |
|----------|-----------|-----------------|-----------------|---|----------|
| Standard | 0mm | 0 - 50kg | HOLD020S | 1 | \$262.00 |
| Light | 30mm | 0 - 50kg | HOLD020A | 1 | \$262.00 |
| Medium | 40mm | 0 - 50kg | HOLD020B | 1 | \$262.00 |
| Heavy | 40mm | 50 - 110kg | HOLD020C | 1 | \$262.00 |

STRUT MOUNTS

| | | | | | |
|-----------------|--|--|----------------|---|---------|
| Steel Strut Top | | | ISST017 | 2 | \$88.00 |
|-----------------|--|--|----------------|---|---------|

TRIM PACKERS

| | | | | |
|------------------------|-----------------------|-------------------------|---|---------|
| 5mm Strut Trim Packer | Nitro Gas / Foam Cell | HILFR05/HILFR05F | 2 | \$30.00 |
| 10mm Strut Trim Packer | Nitro Gas / Foam Cell | HILFR10/HILFR10F | 2 | \$30.00 |
| 15mm Strut Trim Packer | Nitro Gas / Foam Cell | HILFR15/HILFR15F | 2 | \$30.00 |

• ONLY Compatible with Ironman 4x4 Struts (except Pro), lift height subject to 2:1 motion ratio. Unnecessary fitment may lift vehicle too high

CONTROL ARMS

| | | | | | |
|------------------------------|--|--|-----------------|---|----------|
| Pro-Forge Upper Control Arms | | | UCA074FA | 1 | \$882.00 |
|------------------------------|--|--|-----------------|---|----------|

REAR SUSPENSION**SHOCK ABSORBER**

| | | | | | |
|------------------------------|--|--|-----------------|---|----------|
| Nitro Gas - Comfort | | | 12698GRC | 2 | \$160.00 |
| Nitro Gas - Performance | | | 12698GR | 2 | \$160.00 |
| Nitro Gas - Professional | | | 12698GRP | 2 | \$160.00 |
| Foam Cell - Comfort | | | 24698FEC | 2 | \$232.00 |
| Foam Cell - Performance | | | 24698FE | 2 | \$232.00 |
| Foam Cell - Professional | | | 24698FEP | 2 | \$232.00 |
| Foam Cell Pro - Comfort | | | 45698FEC | 2 | \$319.00 |
| Foam Cell Pro - Performance | | | 45698FE | 2 | \$319.00 |
| Foam Cell Pro - Professional | | | 45698FEP | 2 | \$319.00 |

LEAF SPRINGS

| | Est. Lift | Additional Load | | | |
|-------------|-----------|-----------------|-----------------|---|----------|
| Light | 30mm | 0 - 200kg | HOLD021A | 2 | \$421.00 |
| Medium | 45mm | 0 - 300kg | HOLD021B | 2 | \$421.00 |
| Heavy | 45mm | 300kg - 600kg | HOLD021C | 2 | \$435.00 |
| Extra Heavy | 45mm | 600kg - GVM | HOLD021D | 2 | \$435.00 |

U-BOLTS

| | | | | | |
|------------|----------------|--|----------------|---|---------|
| U-Bolt Kit | | | 437UBKL | 2 | \$44.00 |
| U-Bolt Kit | Suits HOLD021D | | 678UBK | 2 | \$44.00 |

POLYURETHANE SPRING BUSHES

| | | | | | |
|----------|--|--|--------------|---|----------|
| Bush Kit | | | 770UK | 1 | \$175.00 |
|----------|--|--|--------------|---|----------|

SPACER KIT

| | | | | | |
|---------------------------|--|--|--------------|---|---------|
| Brake Hose Relocation Kit | | | 1152K | 1 | \$15.00 |
|---------------------------|--|--|--------------|---|---------|

GREASABLE SHACKLES AND PINS

| | | | | | |
|-------------------|--|--|--------------|---|---------|
| Greasable Shackle | | | 1156 | 2 | \$59.00 |
| Non-Greasable Pin | | | 387-1 | 2 | \$30.00 |

HELPER SPRINGS

| | | | | | |
|------------|--|--|----------------|---|----------|
| Add-A-Leaf | | | ISL6010 | 1 | \$175.00 |
|------------|--|--|----------------|---|----------|

LISTING
CONTINUED
OVER THE
PAGE

Isuzu D-Max

8/2019+



Product Description

Part No.

Qty
Req

Retail
ea Inc GST

Please check vehicle date range (if shown) next to product description prior to ordering

SUSPENSION KIT - Specify Front Coil Springs When Ordering

| | | |
|-----------------------------|--------------------|-----------|
| Light - Nitro Gas | HOLD021AKG3 | \$2157.00 |
| Light - Foam Cell | HOLD021AKF3 | \$2360.00 |
| Light - Foam Cell Pro | HOLD021AKP3 | \$2824.00 |
| Medium - Nitro Gas | HOLD021BKG3 | \$2157.00 |
| Medium - Foam Cell | HOLD021BKF3 | \$2360.00 |
| Medium - Foam Cell Pro | HOLD021BKP3 | \$2824.00 |
| Heavy - Nitro Gas | HOLD021CKG3 | \$2187.00 |
| Heavy - Foam Cell | HOLD021CKF3 | \$2389.00 |
| Heavy - Foam Cell Pro | HOLD021CKP3 | \$2852.00 |
| Extra Heavy - Nitro Gas | HOLD021DKG3 | \$2187.00 |
| Extra Heavy - Foam Cell | HOLD021DKF3 | \$2389.00 |
| Extra Heavy - Foam Cell Pro | HOLD021DKP3 | \$2852.00 |

SUSPENSION KIT CONTENTS

| | | | |
|-----------------------|--------------|----------------------------|---------------------------|
| Shock Absorbers | Coil Springs | Polyurethane Spring Bushes | Brake Hose Relocation Kit |
| Strut Shock Absorbers | Leaf Springs | U-Bolts | |



OPTIONS AVAILABLE FOR THIS VEHICLE - SEE PAGE 381

Isuzu D-Max

2/2017 to 7/2019

Product Description

Part No.

Qty
ReqRetail
ea Inc GST*Please check vehicle date range (if shown) next to product description prior to ordering***ACCESSORIES TO SUIT ISUZU D-MAX - 2/2017-7/2019****STEEL WINCH BULL BARS (WILL NOT FIT NARROW BODY)**

| | | |
|---|-----------|-----------|
| Commercial | BBC058 | \$1723.00 |
| Commercial Deluxe | BBCD058 | \$2345.00 |
| Proguard No Loop | BBT058-NL | \$1939.00 |
| Proguard Single Loop Kit | BB058-SL | \$352.00 |
| Proguard Triple Loop Kit | BB058-TL | \$423.00 |
| Driving Light / Lightbar Patch Loom - Factory LED Headlight models only | IPL058 | \$33.00 |

- Can also be fitted to both 2WD and 4WD models.

STEEL SIDE STEPS AND RAILS - FITS DUAL, SPACE AND SINGLE CAB MODELS ONLY

| | | |
|----------------------|------------|-----------|
| Side Steps | SS057 | \$1006.00 |
| Side Rails | SS057 RAIL | \$332.00 |
| Side Steps and Rails | SSR057 | \$1207.00 |

TOWING

| | | |
|---|-------------|-----------|
| Class 4 Towbar - Compatible with Factory Rear Bumper | TB041 | \$608.00 |
| Rear Protection Towbar - Full Rear Bumper Replacement | RTB041 | \$1388.00 |
| Rear Protection Towbar Plates (Pair) | RTBPLATE002 | \$153.00 |
| Towbar Wiring Loom - Plug and Play | ITBL041 | \$162.00 |

RECOVERY POINTS - IRONMAN 4X4 BULL BAR ONLY

| | | |
|--|--------|----------|
| Recovery Points - 5000kg rating (Pair) | IRP058 | \$323.00 |
|--|--------|----------|

SNORKEL

| | | |
|-------------------|-------------|----------|
| 3.0L Turbo Diesel | ISNORKEL041 | \$437.00 |
|-------------------|-------------|----------|

LONG RANGE FUEL TANK

| | | |
|---|---------|-----------|
| 145L* Diesel only - Fits Dual Cab Automatic Transmission only | TANK057 | \$1180.00 |
|---|---------|-----------|

- * Usable volume may differ to the stated tank capacity

PREMIUM UNDERBODY PROTECTION

| | | |
|-----------------------------|--------|----------|
| Engine Bay and Transmission | UBP041 | \$782.00 |
|-----------------------------|--------|----------|

LOCKSAFE DRAWER SYSTEMS

| | | |
|------------------------|---------|-----------|
| Twin Drawers - 1300mm | ITD1300 | \$1536.00 |
| Single Drawer - 1300mm | ISD1300 | \$932.00 |
| Wing Kit - 1300mm* | ITDW038 | \$367.00 |

- * Designed to suit factory tubs, will not suit ute liner without modification

CANOPY - ABS PLASTIC (SIDE LIFT UP WINDOWS AND CENTRAL LOCKING REAR DOOR) - FITS 4X4 AND 4X2 DUAL CAB MODELS

| | | |
|----------------------|--------------|-----------|
| Pre-Primed | CANOPY020-P | \$3238.00 |
| Blue (565) | CANOPY020-B | \$3856.00 |
| Graphite (563) | CANOPY020-GG | \$3856.00 |
| Cosmic Black (523) | CANOPY020-CB | \$3856.00 |
| ABS Canopy Rack Feet | IRRFETABS14 | \$287.00 |

- See Page 38 for 1.4m Roof Rack options and pricing.

- * Pre-primed canopies, plus colour coding.

FENDER FLARE KITS

| | | |
|--|---------|----------|
| Matte Black Smooth Finish 6" (Suits Dual Cab Only) | IFF6058 | \$499.00 |
|--|---------|----------|

SEAT COVER

| | | |
|------------------------|----------|----------|
| Canvas Comfort - Front | ICSC040F | \$420.00 |
| Canvas Comfort - Rear | ICSC040R | \$420.00 |

BREATHER KIT

| | | |
|---|----------|----------|
| Universal Twin Manifold Filtered Breather Kit | IDIFFBRE | \$115.00 |
|---|----------|----------|



LISTING
CONTINUED
OVER THE
PAGE



Product Description

Part No.

Qty
Req

Retail
ea Inc GST

Please check vehicle date range (if shown) next to product description prior to ordering

SUSPENSION TO SUIT ISUZU D-MAX - 2016-7/2019

FRONT SUSPENSION

SHOCK ABSORBER

| | | | | | |
|-----------------------------------|--|--|----------------|---|----------|
| Nitro Gas Strut - Performance | | | 12745GR | 2 | \$232.00 |
| Foam Cell Strut - Performance | | | 24745FE | 2 | \$262.00 |
| Foam Cell Pro Strut - Performance | | | 45745FE | 2 | \$406.00 |

COIL SPRINGS

| | Est. Lift | Additional Load | | | |
|--------|-----------|-----------------|-----------------|---|----------|
| Medium | 40mm | 0 - 50kg | HOLD020A | 1 | \$262.00 |
| Heavy | 40mm | 50 - 110kg | HOLD020B | 1 | \$262.00 |

STRUT MOUNTS

| | | | | | |
|-----------------|--|--|----------------|---|---------|
| Steel Strut Top | | | ISST017 | 2 | \$88.00 |
|-----------------|--|--|----------------|---|---------|

TRIM PACKERS

| | | | | | |
|------------------------|--|-----------------------|-------------------------|---|---------|
| 5mm Strut Trim Packer | | Nitro Gas / Foam Cell | HILFR05/HILFR05F | 2 | \$30.00 |
| 10mm Strut Trim Packer | | Nitro Gas / Foam Cell | HILFR10/HILFR10F | 2 | \$30.00 |
| 15mm Strut Trim Packer | | Nitro Gas / Foam Cell | HILFR15/HILFR15F | 2 | \$30.00 |

• ONLY Compatible with Ironman 4x4 Struts (except Pro), lift height subject to 2:1 motion ratio. Unnecessary fitment may lift vehicle too high

CONTROL ARMS

| | | | | | |
|------------------------------|--|--|------------------|---|----------|
| Pro-Forge Upper Control Arms | | | UCA041FAS | 1 | \$882.00 |
|------------------------------|--|--|------------------|---|----------|

REAR SUSPENSION

SHOCK ABSORBER

| | | | | | |
|------------------------------|--|--|-----------------|---|----------|
| Nitro Gas - Comfort | | | 12636GRC | 2 | \$160.00 |
| Nitro Gas - Performance | | | 12636GR | 2 | \$160.00 |
| Nitro Gas - Professional | | | 12636GRP | 2 | \$160.00 |
| Foam Cell - Comfort | | | 24636FEC | 2 | \$232.00 |
| Foam Cell - Performance | | | 24636FE | 2 | \$232.00 |
| Foam Cell - Professional | | | 24636FEP | 2 | \$232.00 |
| Foam Cell Pro - Comfort | | | 45636FEC | 2 | \$319.00 |
| Foam Cell Pro - Performance | | | 45636FE | 2 | \$319.00 |
| Foam Cell Pro - Professional | | | 45636FEP | 2 | \$319.00 |

LEAF SPRINGS

| | Est. Lift | Additional Load | | | |
|-------------|-----------|-----------------|-----------------|---|----------|
| Light | 30mm | 0 - 200kg | HOLD021A | 2 | \$421.00 |
| Medium | 45mm | 0 - 300kg | HOLD021B | 2 | \$421.00 |
| Heavy | 45mm | 300kg - 600kg | HOLD021C | 2 | \$435.00 |
| Extra Heavy | 45mm | 600kg - GVM | HOLD021D | 2 | \$435.00 |

U-BOLTS

| | | | | | |
|------------|--|----------------|----------------|---|---------|
| U-Bolt Kit | | | 437UBKL | 2 | \$44.00 |
| U-Bolt Kit | | Suits HOLD021D | 678UBK | 2 | \$44.00 |

POLYURETHANE SPRING BUSHES

| | | | | | |
|----------|--|--|--------------|---|----------|
| Bush Kit | | | 770UK | 1 | \$175.00 |
|----------|--|--|--------------|---|----------|

SPACER KIT

| | | | | | |
|---------------------------|--|--|----------------|---|---------|
| Brake Hose Relocation Kit | | | 1152K | 1 | \$15.00 |
| Tailshaft Spacer | | | ITSS021 | 1 | \$88.00 |

GREASABLE SHACKLES AND PINS

| | | | | | |
|-------------------|--|--|--------------|---|---------|
| Greasable Shackle | | | 1148 | 2 | \$59.00 |
| Non-Greasable Pin | | | 387-1 | 2 | \$30.00 |

HELPER SPRINGS

| | | | | | |
|------------|--|--|----------------|---|----------|
| Add-A-Leaf | | | ISL6010 | 1 | \$175.00 |
|------------|--|--|----------------|---|----------|



2016 to 7/2019

Isuzu D-Max

Product Description

Part No.

**Qty
Req**

**Retail
ea Inc GST**

Please check vehicle date range (if shown) next to product description prior to ordering

SUSPENSION KIT - Specify Front Coil Springs When Ordering

| | | |
|-----------------------------|-------------|-----------|
| Light - Nitro Gas | HOLD021AKG1 | \$2157.00 |
| Light - Foam Cell | HOLD021AKF1 | \$2360.00 |
| Light - Foam Cell Pro | HOLD021AKP1 | \$2824.00 |
| Medium - Nitro Gas | HOLD021BKG1 | \$2157.00 |
| Medium - Foam Cell | HOLD021BKF1 | \$2360.00 |
| Medium - Foam Cell Pro | HOLD021BKP1 | \$2824.00 |
| Heavy - Nitro Gas | HOLD021CKG1 | \$2187.00 |
| Heavy - Foam Cell | HOLD021CKF1 | \$2389.00 |
| Heavy - Foam Cell Pro | HOLD021CKP1 | \$2852.00 |
| Extra Heavy - Nitro Gas | HOLD021DKG1 | \$2187.00 |
| Extra Heavy - Foam Cell | HOLD021DKF1 | \$2389.00 |
| Extra Heavy - Foam Cell Pro | HOLD021DKP1 | \$2852.00 |

SUSPENSION KIT CONTENTS

| | | | |
|-----------------------|--------------|----------------------------|---------------------------|
| Shock Absorbers | Coil Springs | U-Bolts | Brake Hose Relocation Kit |
| Strut Shock Absorbers | Leaf Springs | Polyurethane Spring Bushes | |



OPTIONS AVAILABLE FOR THIS VEHICLE - SEE PAGE 382



Product Description

Part No.

Qty
ReqRetail
ea Inc GST

Please check vehicle date range (if shown) next to product description prior to ordering

ACCESSORIES TO SUIT ISUZU D-MAX - 6/2012-1/2017

STEEL WINCH BULL BARS - WILL NOT FIT NARROW BODY

| | | |
|---|---------|-----------|
| Commercial | BBC041 | \$1723.00 |
| Commercial Deluxe | BBCD041 | \$2345.00 |
| Driving Light / Lightbar Patch Loom - Factory LED Headlight models only | IPL058 | \$33.00 |
| • Can also be fitted to both 2WD and 4WD models. | | |

STEEL SIDE STEPS AND RAILS

| | | |
|----------------------|------------|-----------|
| Side Steps | SS057 | \$1006.00 |
| Side Rails | SS057 RAIL | \$332.00 |
| Side Steps and Rails | SSR057 | \$1207.00 |

TOWING

| | | |
|---|-------------|-----------|
| Class 4 Towbar - Compatible with Factory Rear Bumper | TB041 | \$608.00 |
| Rear Protection Towbar - Full Rear Bumper Replacement | RTB041 | \$1388.00 |
| Rear Protection Towbar Plates (Pair) | RTBPLATE002 | \$153.00 |
| Towbar Wiring Loom - Plug and Play | ITBL041 | \$162.00 |

RECOVERY POINTS - IRONMAN 4X4 BULL BAR ONLY

| | | |
|--|--------|----------|
| Recovery Points - 5000kg Rating (Pair) | IRP058 | \$323.00 |
|--|--------|----------|

SNORKEL

| | | |
|-------------------|-------------|----------|
| 3.0L Turbo Diesel | ISNORKEL041 | \$437.00 |
|-------------------|-------------|----------|

LONG RANGE FUEL TANK

| | | |
|---|---------|-----------|
| 145L* Diesel only - Fits Dual Cab Automatic Transmission only | TANK057 | \$1180.00 |
| * Usable volume may differ to the stated tank capacity | | |

PREMIUM UNDERBODY PROTECTION

| | | |
|-----------------------------|--------|----------|
| Engine Bay and Transmission | UBP041 | \$782.00 |
|-----------------------------|--------|----------|

LOCKSAFE DRAWER SYSTEMS

| | | |
|--|---------|-----------|
| Twin Drawers - 1300mm | ITD1300 | \$1536.00 |
| Single Drawer - 1300mm | ISD1300 | \$932.00 |
| Wing Kit - 1300mm* | ITDW038 | \$367.00 |
| * Designed to suit factory tubs, will not suit ute liner without modification. | | |

CANOPY ABS PLASTIC (SIDE LIFT UP WINDOWS) - FITS 4X4 AND 4X2 DUAL CAB MODELS

| | | |
|----------------------|--------------|-----------|
| Pre-Primed | CANOPY020-P | \$3238.00 |
| ABS Canopy Rack Feet | IRRFEETABS14 | \$287.00 |

• See Page 38 for 1.4m Roof Rack options and pricing.

* Pre-primed canopies, plus colour coding.

FENDER FLARE KITS

| | | |
|--|---------|----------|
| Matte Black Smooth Finish 6" (Suits Dual Cab Only) | IFF6041 | \$499.00 |
|--|---------|----------|

SEAT COVER

| | | |
|------------------------|----------|----------|
| Canvas Comfort - Front | ICSC040F | \$420.00 |
| Canvas Comfort - Rear | ICSC040R | \$420.00 |

BREATHER KIT

| | | |
|---|----------|----------|
| Universal Twin Manifold Filtered Breather Kit | IDIFFBRE | \$115.00 |
|---|----------|----------|



6/2012 to 1/2017

SUSPENSION TO SUIT

Isuzu D-Max

Product Description

Part No.

Qty
Req

Retail
ea Inc GST

Please check vehicle date range (if shown) next to product description prior to ordering

SUSPENSION TO SUIT ISUZU D-MAX - 6/2012-1/2017

FRONT SUSPENSION

SHOCK ABSORBER

| | | | | | |
|-----------------------------------|--|--|----------------|---|----------|
| Nitro Gas Strut - Performance | | | 12745GR | 2 | \$232.00 |
| Foam Cell Strut - Performance | | | 24745FE | 2 | \$262.00 |
| Foam Cell Pro Strut - Performance | | | 45745FE | 2 | \$406.00 |

COIL SPRINGS

| | Est. Lift | Additional Load | | | |
|----------|-----------|-----------------|-----------------|---|----------|
| Standard | 0mm | 0 - 50kg | HOLD020S | 1 | \$262.00 |
| Light | 30mm | 0 - 50kg | HOLD020A | 1 | \$262.00 |
| Medium | 40mm | 0 - 50kg | HOLD020B | 1 | \$262.00 |
| Heavy | 40mm | 50 - 110kg | HOLD020C | 1 | \$262.00 |

STRUT MOUNTS

| | | | | | |
|-----------------|--|--|----------------|---|---------|
| Steel Strut Top | | | ISST017 | 2 | \$88.00 |
|-----------------|--|--|----------------|---|---------|

TRIM PACKERS

| | | | | |
|------------------------|-----------------------|-------------------------|---|---------|
| 5mm Strut Trim Packer | Nitro Gas / Foam Cell | HILFR05/HILFR05F | 2 | \$30.00 |
| 10mm Strut Trim Packer | Nitro Gas / Foam Cell | HILFR10/HILFR10F | 2 | \$30.00 |
| 15mm Strut Trim Packer | Nitro Gas / Foam Cell | HILFR15/HILFR15F | 2 | \$30.00 |

• ONLY Compatible with Ironman 4x4 Struts (except Pro), lift height subject to 2:1 motion ratio. Unnecessary fitment may lift vehicle too high

CONTROL ARMS

| | | | | | |
|------------------------------|--|--|------------------|---|----------|
| Pro-Forge Upper Control Arms | | | UCA041FAS | 1 | \$882.00 |
|------------------------------|--|--|------------------|---|----------|

REAR SUSPENSION

SHOCK ABSORBER

| | | | | | |
|------------------------------|--|--|-----------------|---|----------|
| Nitro Gas - Comfort | | | 12636GRC | 2 | \$160.00 |
| Nitro Gas - Performance | | | 12636GR | 2 | \$160.00 |
| Nitro Gas - Professional | | | 12636GRP | 2 | \$160.00 |
| Foam Cell - Comfort | | | 24636FEC | 2 | \$232.00 |
| Foam Cell - Performance | | | 24636FE | 2 | \$232.00 |
| Foam Cell - Professional | | | 24636FEP | 2 | \$232.00 |
| Foam Cell Pro - Comfort | | | 45636FEC | 2 | \$319.00 |
| Foam Cell Pro - Performance | | | 45636FE | 2 | \$319.00 |
| Foam Cell Pro - Professional | | | 45636FEP | 2 | \$319.00 |

LEAF SPRINGS

| | Est. Lift | Additional Load | | | |
|-------------|-----------|-----------------|-----------------|---|----------|
| Light | 30mm | 0 - 200kg | HOLD021A | 2 | \$421.00 |
| Medium | 45mm | 0 - 300kg | HOLD021B | 2 | \$421.00 |
| Heavy | 45mm | 300kg - 600kg | HOLD021C | 2 | \$435.00 |
| Extra Heavy | 45mm | 600kg - GVM | HOLD021D | 2 | \$435.00 |

U-BOLTS

| | | | | | |
|------------|----------------|--|----------------|---|---------|
| U-Bolt Kit | | | 437UBKL | 2 | \$44.00 |
| U-Bolt Kit | Suits HOLD021D | | 678UBK | 2 | \$44.00 |

POLYURETHANE SPRING BUSHES

| | | | | | |
|----------|--|--|--------------|---|----------|
| Bush Kit | | | 770UK | 1 | \$175.00 |
|----------|--|--|--------------|---|----------|

SPACER KIT

| | | | | | |
|---------------------------|--|--|----------------|---|---------|
| Brake Hose Relocation Kit | | | 1152K | 1 | \$15.00 |
| Tailshaft Spacer | | | ITSS021 | 1 | \$88.00 |

GREASABLE SHACKLES AND PINS

| | | | | | |
|-------------------|--|--|--------------|---|---------|
| Greasable Shackle | | | 1148 | 2 | \$59.00 |
| Non-Greasable Pin | | | 387-1 | 2 | \$30.00 |

HELPER SPRINGS

| | | | | | |
|------------|--|--|----------------|---|----------|
| Add-A-Leaf | | | ISL6010 | 1 | \$175.00 |
|------------|--|--|----------------|---|----------|

LISTING
CONTINUED
OVER THE
PAGE



Isuzu D-Max

6/2012 to 1/2017



Product Description

Part No.

**Qty
Req**

**Retail
ea Inc GST**

Please check vehicle date range (if shown) next to product description prior to ordering

SUSPENSION KIT - Specify Front Coil Springs When Ordering

| | | |
|-----------------------------|-------------------|-----------|
| Light - Nitro Gas | HOLD021AKG | \$2157.00 |
| Light - Foam Cell | HOLD021AKF | \$2360.00 |
| Light - Foam Cell Pro | HOLD021AKP | \$2824.00 |
| Medium - Nitro Gas | HOLD021BKG | \$2157.00 |
| Medium - Foam Cell | HOLD021BKF | \$2360.00 |
| Medium - Foam Cell Pro | HOLD021BKP | \$2824.00 |
| Heavy - Nitro Gas | HOLD021CKG | \$2187.00 |
| Heavy - Foam Cell | HOLD021CKF | \$2389.00 |
| Heavy - Foam Cell Pro | HOLD021CKP | \$2852.00 |
| Extra Heavy - Nitro Gas | HOLD021DKG | \$2187.00 |
| Extra Heavy - Foam Cell | HOLD021DKF | \$2389.00 |
| Extra Heavy - Foam Cell Pro | HOLD021DKP | \$2852.00 |

SUSPENSION KIT CONTENTS

| | | | |
|-----------------------|--------------|----------------------------|---------------------------|
| Shock Absorbers | Coil Springs | U-Bolts | Brake Hose Relocation Kit |
| Strut Shock Absorbers | Leaf Springs | Polyurethane Spring Bushes | |



OPTIONS AVAILABLE FOR THIS VEHICLE - SEE PAGE 382



Low Ride 2WD
2012+

Product Description

Part No.

Qty
ReqRetail
ea Inc GST

Please check vehicle date range (if shown) next to product description prior to ordering

SUSPENSION TO SUIT ISUZU D-MAX - 2012+

FRONT SUSPENSION

SHOCK ABSORBER

Nitro Gas Strut - Performance **12797GR** 2 \$232.00

COIL SPRINGS

| | Est. Lift | Additional Load | Part No. | Qty | Retail Price |
|--------|-----------|-----------------|----------------|-----|--------------|
| Medium | 35mm | 0 - 50kg | TOY038B | 1 | \$262.00 |
| Heavy | 35mm | 50 - 110kg | TOY038C | 1 | \$262.00 |

TRIM PACKERS

| | | | | |
|------------------------|-----------------------|-------------------------|---|---------|
| 5mm Strut Trim Packer | Nitro Gas / Foam Cell | HILFR05/HILFR05F | 2 | \$30.00 |
| 10mm Strut Trim Packer | Nitro Gas / Foam Cell | HILFR10/HILFR10F | 2 | \$30.00 |
| 15mm Strut Trim Packer | Nitro Gas / Foam Cell | HILFR15/HILFR15F | 2 | \$30.00 |

• ONLY Compatible with Ironman 4x4 Struts (except Pro), lift height subject to 2:1 motion ratio. Unnecessary fitment may lift vehicle too high

REAR SUSPENSION

SHOCK ABSORBER

| | | | | |
|--------------------------|--|-----------------|---|----------|
| Nitro Gas - Comfort | | 12636GRC | 2 | \$160.00 |
| Nitro Gas - Performance | | 12636GR | 2 | \$160.00 |
| Nitro Gas - Professional | | 12636GRP | 2 | \$160.00 |
| Foam Cell - Comfort | | 24636FEC | 2 | \$232.00 |
| Foam Cell - Performance | | 24636FE | 2 | \$232.00 |
| Foam Cell - Professional | | 24636FEP | 2 | \$232.00 |

LEAF SPRINGS

| | Est. Lift | Additional Load | Part No. | Qty | Retail Price |
|--------|-----------|-----------------|-----------------|-----|--------------|
| Medium | 45mm | 0 - 300kg | HOLD023B | 2 | \$392.00 |
| Heavy | 45mm | 300kg - 600kg | HOLD023C | 2 | \$421.00 |

U-BOLTS

U-Bolt Kit **417UBK** 2 \$44.00

POLYURETHANE SPRING BUSHES

Bush Kit **728UK** 1 \$88.00

GREASABLE SHACKLES AND PINS

Greasable Shackle **386-2** 2 \$59.00

HELPER SPRINGS

Add-A-Leaf **ISL6010** 1 \$175.00

SUSPENSION KIT - Specify Front Coil Springs When Ordering

| | | |
|--------------------|-------------------|-----------|
| Medium - Nitro Gas | HOLD023BKG | \$1999.00 |
| Heavy - Nitro Gas | HOLD023CKG | \$2056.00 |

SUSPENSION KIT CONTENTS

Shock Absorbers

Coil Springs

Polyurethane Spring Bushes

Leaf Springs

U-Bolts

Strut Shock Absorbers



Product Description

Part No.

Qty
Req

Retail
ea Inc GST

Please check vehicle date range (if shown) next to product description prior to ordering

ACCESSORIES TO SUIT ISUZU D-MAX - 2007-6/2012

STEEL WINCH BULL BARS

Commercial Deluxe

BBCD020

\$2345.00

• Can also be fitted to both 2WD and 4WD models.

STEEL SIDE STEPS AND RAILS - FITS DUAL CAB MODELS ONLY

Side Steps

SS001

\$1006.00

Side Steps and Rails

SSR006

\$1207.00

SNORKEL

D-MAX 2009+ (Does not fit 4x2 SX model)

ISNORKEL022

\$437.00

UNDERBODY PROTECTION

Engine Bay and Transmission - *While Stocks Last*

IUP009K

\$563.00

LOCKSAFE DRAWER SYSTEMS

Twin Drawers - 1300mm

ITD1300

\$1536.00

Single Drawer - 1300mm

ISD1300

\$932.00

BREATHER KIT

Universal Twin Manifold Filtered Breather Kit

IDIFFBRE

\$115.00



Isuzu D-Max

2003 to 2012

Product Description

Part No.

Qty
ReqRetail
ea Inc GST*Please check vehicle date range (if shown) next to product description prior to ordering***SUSPENSION TO SUIT ISUZU D-MAX - 2003-2012****FRONT SUSPENSION****SHOCK ABSORBER**

| | | | |
|-------------------------|----------------|---|----------|
| Nitro Gas - Performance | 12667GR | 2 | \$160.00 |
| Foam Cell - Performance | 24667FE | 2 | \$232.00 |

TORSION BAR

| | | | |
|----------------------|----------------|---|----------|
| Uprated Torsion Bars | HOLD010 | 1 | \$435.00 |
|----------------------|----------------|---|----------|

- Minimum 60mm downward suspension travel required after adjustment

REAR SUSPENSION**SHOCK ABSORBER**

| | | | |
|--------------------------|-----------------|---|----------|
| Nitro Gas - Comfort | 12636GRC | 2 | \$160.00 |
| Nitro Gas - Performance | 12636GR | 2 | \$160.00 |
| Nitro Gas - Professional | 12636GRP | 2 | \$160.00 |
| Foam Cell - Comfort | 24636FEC | 2 | \$232.00 |
| Foam Cell - Performance | 24636FE | 2 | \$232.00 |
| Foam Cell - Professional | 24636FEP | 2 | \$232.00 |

LEAF SPRINGS

| | Est. Lift | Additional Load | | | |
|-------------|-----------|-----------------|-----------------|---|----------|
| Medium | 40mm | 0 - 300kg | HOLD006B | 2 | \$392.00 |
| Heavy | 40mm | 300kg - 600kg | HOLD006C | 2 | \$421.00 |
| Extra Heavy | 40mm | 600 kg - GVM | HOLD006D | 2 | \$421.00 |

U-BOLTS

| | | | |
|------------|---------------|---|---------|
| U-Bolt Kit | 417UBK | 2 | \$44.00 |
|------------|---------------|---|---------|

POLYURETHANE SPRING BUSHES

| | | | |
|----------|---------------|---|---------|
| Bush Kit | 728TUK | 1 | \$88.00 |
|----------|---------------|---|---------|

GREASABLE SHACKLES AND PINS

| | | | |
|-------------------|--------------|---|---------|
| Greasable Shackle | 386-2 | 2 | \$59.00 |
| Non-Greasable Pin | 387-1 | 2 | \$30.00 |

HELPER SPRINGS

| | | | |
|------------|----------------|---|----------|
| Add-A-Leaf | ISL6010 | 1 | \$175.00 |
|------------|----------------|---|----------|

- Load Plus not suitable for Rodeo / Colorado / D-Max with OEM springs due to interleaf liners

SUSPENSION KIT

| | | |
|-------------------------|-------------------|-----------|
| Medium - Nitro Gas | HOLD006BKG | \$2028.00 |
| Medium - Foam Cell | HOLD006BKF | \$2317.00 |
| Heavy - Nitro Gas | HOLD006CKG | \$2085.00 |
| Heavy - Foam Cell | HOLD006CKF | \$2375.00 |
| Extra Heavy - Nitro Gas | HOLD006DKG | \$2085.00 |
| Extra Heavy - Foam Cell | HOLD006DKF | \$2375.00 |

SUSPENSION KIT CONTENTS

| | | |
|-----------------|--------------|----------------------------|
| Shock Absorbers | Torsion Bars | Polyurethane Spring Bushes |
| Leaf Springs | U-Bolts | |

ACCESSORIES TO SUIT

Isuzu MU-X

8/2021+



Product Description

DATE AVAILABLE

Part No.

Qty Req

Retail ea Inc GST

Please check vehicle date range (if shown) next to product description prior to ordering

ACCESSORIES TO SUIT ISUZU MU-X - 8/2021+

STEEL WINCH BULL BARS

| | | | |
|--------------------------------------|--|-----------|-----------|
| Commercial Deluxe - (8/2021+) | | BBCD095 | \$2387.00 |
| Proguard No Loop - (8/2021+) | | BBT095-NL | \$1973.00 |
| Proguard Single Loop Kit - (8/2021+) | | BB095-SL | \$352.00 |
| Proguard Triple Loop Kit - (8/2021+) | | BB095-TL | \$423.00 |

STEEL SIDE STEPS AND RAILS

| | | | |
|----------------------|---------|------------|-----------|
| Side Steps | Q1 2023 | SS095 | \$1006.00 |
| Side Rails | Q1 2023 | SS095 RAIL | \$332.00 |
| Side Steps and Rails | Q1 2023 | SSR095 | \$1207.00 |

RECOVERY POINTS - IRONMAN 4X4 BULL BAR ONLY

| | | | |
|--|--|--------|----------|
| Recovery Points - 5000kg Rating (Pair) | | IRP074 | \$227.00 |
|--|--|--------|----------|

SNORKEL

| | | | |
|----------------|--|-------------|----------|
| MU-X (8/2021+) | | ISNORKEL074 | \$437.00 |
|----------------|--|-------------|----------|

PREMIUM UNDERBODY PROTECTION

| | | | |
|-----------------------------|--|---------|----------|
| Engine Bay and Transmission | | UBP074S | \$745.00 |
|-----------------------------|--|---------|----------|

ACCESSORIES TO SUIT

Isuzu MU-X

2014 to 2/2017
(Facelift) 3/2017 to 7/2021



Product Description

Part No.

Qty Req

Retail ea Inc GST

ACCESSORIES TO SUIT ISUZU MU-X - 2014-7/2021

STEEL WINCH BULL BARS

| | | | |
|---|--|-----------|-----------|
| Commercial Deluxe - (2014 to 2/2017) | | BBCD049 | \$2345.00 |
| Commercial Deluxe - (3/2017 to 7/2021) | | BBCD061 | \$2345.00 |
| Protector - (2014 to 2/2017) - <i>While Stocks Last</i> | | BBT049 | \$1995.00 |
| Proguard No Loop - (3/2017 to 7/2021) | | BBT061-NL | \$1939.00 |
| Proguard Single Loop Kit - (3/2017 to 7/2021) | | BB061-SL | \$352.00 |
| Proguard Triple Loop Kit - (3/2017 to 7/2021) | | BB061-TL | \$423.00 |
| Driving Light / Lightbar Patch Loom - Factory LED Headlight models only | | IPL058 | \$33.00 |

STEEL SIDE STEPS AND RAILS

| | | | |
|----------------------|--|------------|-----------|
| Side Steps | | SS044 | \$1006.00 |
| Side Rails | | SS044 RAIL | \$332.00 |
| Side Steps and Rails | | SSR044 | \$1207.00 |

RECOVERY POINTS - IRONMAN 4X4 BULL BAR ONLY

| | | | |
|--|--|--------|----------|
| Recovery Points - 5000kg Rating (Pair) | | IRP058 | \$323.00 |
|--|--|--------|----------|

SNORKEL

| | | | |
|--------------------------------------|--|-------------|----------|
| 3.0L Turbo Diesel - (2014 to 2/2017) | | ISNORKEL041 | \$437.00 |
|--------------------------------------|--|-------------|----------|

PREMIUM UNDERBODY PROTECTION

| | | | |
|-----------------------------|--|--------|----------|
| Engine Bay and Transmission | | UBP041 | \$782.00 |
|-----------------------------|--|--------|----------|

ALLOY ROOF RACKS

| | | | |
|---------------------------------------|--|------------------|-----------|
| Cage Style - 1.8m x 1.25m | | IRRCAGE18-ALLOY | \$1201.00 |
| Trade Style - 1.8m x 1.25m (Open end) | | IRRTRADE18-ALLOY | \$1183.00 |
| Flat Rack - 1.8m x 1.25m | | IRRTFLAT18-ALLOY | \$1167.00 |

STEEL AND ALLOY ROOF RACK - MOUNT KITS

| | | | |
|------------------------------------|--|------------|----------|
| MU-X Mount to suit LS-T model only | | IRRFEETMUX | \$228.00 |
|------------------------------------|--|------------|----------|

• Will only fit vehicles with factory fitted roof bars.

FENDER FLARE KITS

| | | | |
|---|--|---------|----------|
| Matte Black Smooth Finish 6" (Suits Facelift 3/2017 to 7/2021 Only) | | IFF6049 | \$499.00 |
|---|--|---------|----------|

SEAT COVER

| | | | |
|------------------------|--|----------|----------|
| Canvas Comfort - Front | | ICSC040F | \$420.00 |
| Canvas Comfort - Rear | | ICSC049R | \$420.00 |



Isuzu MU-X

2013 to 7/2021
8/2021+

Product Description

Part No.

Qty
ReqRetail
ea Inc GST

Please check vehicle date range (if shown) next to product description prior to ordering

SUSPENSION TO SUIT ISUZU MU-X - 2013+

FRONT SUSPENSION

SHOCK ABSORBER

| | | | | | |
|--|--|--|----------------|---|----------|
| Nitro Gas Strut - Performance - (2013 to 7/2021) | | | 12745GR | 2 | \$232.00 |
| Nitro Gas Strut - Performance - (8/2021+) | | | 12845GR | 2 | \$232.00 |
| Foam Cell Strut - Performance - (2013 to 7/2021) | | | 24745FE | 2 | \$262.00 |
| Foam Cell Strut - Performance - (8/2021+) | | | 24845FE | 2 | \$262.00 |
| Foam Cell Pro Strut - Performance - (2013 to 7/2021) | | | 45745FE | 2 | \$406.00 |
| Foam Cell Pro Strut - Performance - (8/2021+) | | | 45845FE | 2 | \$406.00 |

COIL SPRINGS

| | Est. Lift | Additional Load | | | |
|----------|-----------|-----------------|-----------------|---|----------|
| Standard | 0mm | 0 - 50kg | HOLD020S | 1 | \$262.00 |
| Light | 30mm | 0 - 50kg | HOLD020A | 1 | \$262.00 |
| Medium | 40mm | 0 - 50kg | HOLD020B | 1 | \$262.00 |
| Heavy | 40mm | 50 - 110kg | HOLD020C | 1 | \$262.00 |

STRUT MOUNTS

| | | | | | |
|-----------------|--|--|----------------|---|---------|
| Steel Strut Top | | | ISST017 | 2 | \$88.00 |
|-----------------|--|--|----------------|---|---------|

TRIM PACKERS

| | | | | |
|------------------------|-----------------------|-------------------------|---|---------|
| 5mm Strut Trim Packer | Nitro Gas / Foam Cell | HILFR05/HILFR05F | 2 | \$30.00 |
| 10mm Strut Trim Packer | Nitro Gas / Foam Cell | HILFR10/HILFR10F | 2 | \$30.00 |
| 15mm Strut Trim Packer | Nitro Gas / Foam Cell | HILFR15/HILFR15F | 2 | \$30.00 |

• ONLY Compatible with Ironman 4x4 Struts (except Pro), lift height subject to 2:1 motion ratio. Unnecessary fitment may lift vehicle too high

CONTROL ARMS

| | | | | |
|---|--|------------------|---|----------|
| Pro-Forge Upper Control Arms - (2013 to 7/2021) | | UCA041FAS | 1 | \$882.00 |
| Pro-Forge Upper Control Arms - (8/2021+) | | UCA074FA | 1 | \$882.00 |

REAR SUSPENSION

SHOCK ABSORBER

| | | | | | |
|-----------------------------|--|--|-----------------|---|----------|
| Nitro Gas - Comfort | | | 12746GRC | 2 | \$160.00 |
| Nitro Gas - Performance | | | 12746GR | 2 | \$160.00 |
| Foam Cell - Comfort | | | 24746FEC | 2 | \$232.00 |
| Foam Cell - Performance | | | 24746FE | 2 | \$232.00 |
| Foam Cell Pro - Comfort | | | 45746FEC | 2 | \$319.00 |
| Foam Cell Pro - Performance | | | 45746FE | 2 | \$319.00 |

COIL SPRINGS

| | Est. Lift | Additional Load | | | |
|--------|-----------|-----------------|-----------------|---|----------|
| Medium | 40mm | 0 - 250kg | HOLD008A | 1 | \$262.00 |
| Heavy | 40mm | 250kg - GVM | HOLD008B | 1 | \$262.00 |

SUSPENSION KIT - Specify Front Coil Springs When Ordering

| | | |
|---|--------------------|-----------|
| Medium - Nitro Gas - (2013 to 7/2021) | HOLD020BKG | \$1304.00 |
| Medium - Nitro Gas - (8/2021+) | HOLD020BKG1 | \$1304.00 |
| Medium - Foam Cell - (2013 to 7/2021) | HOLD020BKF | \$1506.00 |
| Medium - Foam Cell - (8/2021+) | HOLD020BKF1 | \$1506.00 |
| Medium - Foam Cell Pro - (2013 to 7/2021) | HOLD020BKP | \$1969.00 |
| Medium - Foam Cell Pro - (8/2021+) | HOLD020BKP1 | \$1969.00 |
| Heavy - Nitro Gas - (2013 to 7/2021) | HOLD020CKG | \$1304.00 |
| Heavy - Nitro Gas - (8/2021+) | HOLD020CKG1 | \$1304.00 |
| Heavy - Foam Cell - (2013 to 7/2021) | HOLD020CKF | \$1506.00 |
| Heavy - Foam Cell - (8/2021+) | HOLD020CKF1 | \$1506.00 |
| Heavy - Foam Cell Pro - (2013 to 7/2021) | HOLD020CKP | \$1969.00 |

SUSPENSION KIT CONTENTS

Shock Absorbers

Coil Springs

Isuzu Trooper

1992+



Product Description

Part No.

Qty
Req

Retail
ea Inc GST

Please check vehicle date range (if shown) next to product description prior to ordering

SUSPENSION TO SUIT ISUZU TROOPER - 1992+

FRONT SUSPENSION

SHOCK ABSORBER

| | | | |
|-------------------------|----------------|---|----------|
| Nitro Gas - Performance | 12643GR | 2 | \$160.00 |
| Foam Cell - Performance | 24643FE | 2 | \$232.00 |

TORSION BAR

| | | | |
|-----------------------|----------------|---|----------|
| Up-rated Torsion Bars | HOLD009 | 1 | \$435.00 |
|-----------------------|----------------|---|----------|

• Minimum 60mm downward suspension travel required after adjustment

REAR SUSPENSION

SHOCK ABSORBER

| | | | |
|-------------------------|----------------|---|----------|
| Nitro Gas - Performance | 12644GR | 2 | \$160.00 |
| Foam Cell - Performance | 24644FE | 2 | \$232.00 |

COIL SPRINGS

| | Est. Lift | Additional Load | | | |
|--------|-----------|-----------------|-----------------|---|----------|
| Medium | 40mm | 0 - 300kg | HOLD008B | 1 | \$262.00 |
| Heavy | 40mm | 300kg - GVM | HOLD008C | 1 | \$262.00 |

• Use HOLD008C for 3/2001+ Models

SUSPENSION KIT

| | | |
|--------------------|-------------------|-----------|
| Medium - Nitro Gas | HOLD008BKG | \$1333.00 |
| Medium - Foam Cell | HOLD008BKF | \$1622.00 |
| Heavy - Nitro Gas | HOLD008CKG | \$1333.00 |
| Heavy - Foam Cell | HOLD008CKF | \$1622.00 |

SUSPENSION KIT CONTENTS

Shock Absorbers

Leaf Springs

Torsion Bars





11/1986 to 1991

Isuzu Trooper

Product Description

Part No.

Qty
ReqRetail
ea Inc GST

Please check vehicle date range (if shown) next to product description prior to ordering

SUSPENSION TO SUIT ISUZU TROOPER - 11/1986-1991

FRONT SUSPENSION

SHOCK ABSORBER

| | | | | |
|-------------------------|--|----------------|---|----------|
| Nitro Gas - Performance | | 12087GR | 2 | \$160.00 |
| Foam Cell - Performance | | 24087FE | 2 | \$232.00 |

TORSION BAR

| | | | | |
|----------------------|-------------------|-----------------|---|----------|
| Uprated Torsion Bars | 43mm Spline Count | HOLD005A | 1 | \$435.00 |
|----------------------|-------------------|-----------------|---|----------|

• Minimum 60mm downward suspension travel required after adjustment

REAR SUSPENSION

SHOCK ABSORBER

| | | | | |
|-------------------------|--|----------------|---|----------|
| Nitro Gas - Performance | | 12671GR | 2 | \$160.00 |
|-------------------------|--|----------------|---|----------|

LEAF SPRINGS

| | Est. Lift | Additional Load | | | |
|-----------------------|-----------|-----------------|--------------------|---|----------|
| Medium - Drivers Side | 40mm | 0 - 300kg | HOLD004BD/S | 1 | \$392.00 |
| Medium - Near Side | 40mm | 0 - 300kg | HOLD004BN/S | 1 | \$392.00 |
| Heavy - Drivers Side | 40mm | 300kg - GVM | HOLD004CD/S | 1 | \$421.00 |
| Heavy - Near Side | 40mm | 300kg - GVM | HOLD004CN/S | 1 | \$421.00 |

U-BOLTS

| | | | | |
|------------|--|---------------|---|---------|
| U-Bolt Kit | | 451UBK | 2 | \$44.00 |
|------------|--|---------------|---|---------|

POLYURETHANE SPRING BUSHES

| | | | | |
|----------|--|--------------|---|---------|
| Bush Kit | | 747UK | 1 | \$88.00 |
|----------|--|--------------|---|---------|

GREASABLE SHACKLES AND PINS

| | | | | |
|-------------------|--|------------|---|---------|
| Greasable Shackle | | 791 | 2 | \$59.00 |
| Greasable Pin | | 792 | 2 | \$44.00 |

HELPER SPRINGS

| | | | | |
|--------------------------|--|----------------|---|----------|
| Load Plus Helper Springs | | LP3 | 1 | \$165.00 |
| Add-A-Leaf | | ISL6010 | 1 | \$175.00 |

SUSPENSION KIT

| | | | | |
|--------------------|--|-------------------|--|-----------|
| Medium - Nitro Gas | | HOLD007BKG | | \$2317.00 |
| Medium - Foam Cell | | HOLD007BKF | | \$2461.00 |
| Heavy - Nitro Gas | | HOLD007CKG | | \$1953.00 |
| Heavy - Foam Cell | | HOLD007CKF | | \$2520.00 |

SUSPENSION KIT CONTENTS

| | | |
|-----------------|--------------|----------------------------|
| Shock Absorbers | Torsion Bars | Polyurethane Spring Bushes |
| Leaf Springs | U-Bolts | |

Isuzu Trooper

Pre 1986



Product Description

Part No.

Qty
Req

Retail
ea Inc GST

Please check vehicle date range (if shown) next to product description prior to ordering

SUSPENSION TO SUIT ISUZU TROOPER - PRE 1986

FRONT SUSPENSION

SHOCK ABSORBER

| | | | |
|-------------------------|----------------|---|----------|
| Nitro Gas - Performance | 12087GR | 2 | \$160.00 |
| Foam Cell - Performance | 24087FE | 2 | \$232.00 |

TORSION BAR

| | | | |
|-----------------------|-----------------|---|----------|
| Up-rated Torsion Bars | MAZDA005 | 1 | \$435.00 |
|-----------------------|-----------------|---|----------|

• Minimum 60mm downward suspension travel required after adjustment

REAR SUSPENSION

SHOCK ABSORBER

| | | | |
|-------------------------|-----------------|---|----------|
| Nitro Gas - Comfort | 12636GRC | 2 | \$160.00 |
| Nitro Gas - Performance | 12636GR | 2 | \$160.00 |
| Foam Cell - Comfort | 24636FEC | 2 | \$232.00 |
| Foam Cell - Performance | 24636FE | 2 | \$232.00 |

LEAF SPRINGS

| | Est. Lift | Additional Load | | | |
|-----------------------|-----------|-----------------|--------------------|---|----------|
| Medium - Drivers Side | 40mm | 0 - 300kg | HOLD004BD/S | 1 | \$392.00 |
| Medium - Near Side | 40mm | 0 - 300kg | HOLD004BN/S | 1 | \$392.00 |
| Heavy - Drivers Side | 40mm | 300kg - GVM | HOLD004CD/S | 1 | \$421.00 |
| Heavy - Near Side | 40mm | 300kg - GVM | HOLD004CN/S | 1 | \$421.00 |

U-BOLTS

| | | | |
|------------|---------------|---|---------|
| U-Bolt Kit | 451UBK | 2 | \$44.00 |
|------------|---------------|---|---------|

POLYURETHANE SPRING BUSHES

| | | | |
|----------|--------------|---|---------|
| Bush Kit | 747UK | 1 | \$88.00 |
|----------|--------------|---|---------|

GREASABLE SHACKLES AND PINS

| | | | |
|-------------------|------------|---|---------|
| Greasable Shackle | 791 | 2 | \$59.00 |
| Greasable Pin | 792 | 2 | \$44.00 |

HELPER SPRINGS

| | | | |
|--------------------------|----------------|---|----------|
| Load Plus Helper Springs | LP3 | 1 | \$165.00 |
| Add-A-Leaf | ISL6010 | 1 | \$175.00 |

SUSPENSION KIT

| | | |
|--------------------|-------------------|-----------|
| Medium - Nitro Gas | HOLD005BKG | \$2028.00 |
| Medium - Foam Cell | HOLD005BKF | \$2317.00 |
| Heavy - Nitro Gas | HOLD005CKG | \$2085.00 |
| Heavy - Foam Cell | HOLD005CKF | \$2375.00 |

SUSPENSION KIT CONTENTS

| | | |
|-----------------|--------------|----------------------------|
| Shock Absorbers | Torsion Bars | Polyurethane Spring Bushes |
| Leaf Springs | U-Bolts | |



Liberty KK
2007 to 2012

Jeep Cherokee

Product Description

Part No.

Qty
Req

Retail
ea Inc GST

Please check vehicle date range (if shown) next to product description prior to ordering

SUSPENSION TO SUIT JEEP CHEROKEE - 2007-2012

FRONT SUSPENSION

SHOCK ABSORBER

| | | | | |
|-------------------------|--|----------------|---|----------|
| Nitro Gas - Performance | | 12711GR | 2 | \$232.00 |
|-------------------------|--|----------------|---|----------|

TRIM PACKERS

| | | | | |
|------------------------|-----------|----------------|---|---------|
| 5mm Strut Trim Packer | Nitro Gas | HILFR05 | 2 | \$30.00 |
| 10mm Strut Trim Packer | Nitro Gas | HILFR10 | 2 | \$30.00 |
| 15mm Strut Trim Packer | Nitro Gas | HILFR15 | 2 | \$30.00 |

• ONLY Compatible with Ironman 4x4 Struts, lift height subject to 2:1 motion ratio. Unnecessary fitment may lift vehicle too high

REAR SUSPENSION

SHOCK ABSORBER

| | | | | |
|-------------------------|--|----------------|---|----------|
| Nitro Gas - Performance | | 12712GR | 2 | \$160.00 |
|-------------------------|--|----------------|---|----------|

• Vehicles with monocoque body construction can be subject to increased NVH (Noise) with upgraded suspension installed



Jeep Cherokee

Liberty KJ
2001 to 2006



Product Description

Part No.

Qty
Req

Retail
ea Inc GST

Please check vehicle date range (if shown) next to product description prior to ordering

SUSPENSION TO SUIT JEEP CHEROKEE - 2001-2006

FRONT SUSPENSION

SHOCK ABSORBER

| | | | | | |
|-------------------------------|--|--|----------------|---|----------|
| Nitro Gas Strut - Performance | | | 12711GR | 2 | \$232.00 |
|-------------------------------|--|--|----------------|---|----------|

COIL SPRINGS

| | Est. Lift | Additional Load | | | |
|-----------------|-----------|-----------------|-----------------|---|----------|
| Medium | 40mm | 0 - 50kg | JEEP014B | 1 | \$262.00 |
| Heavy or Diesel | 40mm | 50 - 100kg | JEEP014C | 1 | \$262.00 |

TRIM PACKERS

| | | | | | |
|------------------------|--|-----------|----------------|---|---------|
| 5mm Strut Trim Packer | | Nitro Gas | HILFR05 | 2 | \$30.00 |
| 10mm Strut Trim Packer | | Nitro Gas | HILFR10 | 2 | \$30.00 |
| 15mm Strut Trim Packer | | Nitro Gas | HILFR15 | 2 | \$30.00 |

• ONLY Compatible with Ironman 4x4 Struts, lift height subject to 2:1 motion ratio. Unnecessary fitment may lift vehicle too high

REAR SUSPENSION

SHOCK ABSORBER

| | | | | | |
|-------------------------|--|--|----------------|---|----------|
| Nitro Gas - Performance | | | 12712GR | 2 | \$160.00 |
|-------------------------|--|--|----------------|---|----------|

COIL SPRINGS

| | Est. Lift | Additional Load | | | |
|--------|-----------|-----------------|-----------------|---|----------|
| Medium | 40mm | 0 - 200kg | JEEP015B | 1 | \$262.00 |

SUSPENSION KIT - Specify Front Coil Springs When Ordering

| | | | |
|-----------------------------|--|--------------------|-----------|
| Medium - Nitro Gas | | JEEP014BKG | \$1304.00 |
| Medium - Nitro Gas (Diesel) | | JEEP014BKG1 | \$1304.00 |

• Vehicles with monocoque body construction can be subject to increased NVH (Noise) with upgraded suspension installed

SUSPENSION KIT CONTENTS

Shock Absorbers

Coil Springs

Jeep Cherokee



XJ
1984+

Product Description

Part No.

Qty
Req

Retail
ea Inc GST

Please check vehicle date range (if shown) next to product description prior to ordering

SUSPENSION TO SUIT JEEP CHEROKEE - 1984+

FRONT SUSPENSION

SHOCK ABSORBER

| | | | | | |
|-------------------------|--|--|----------------|---|----------|
| Nitro Gas - Performance | | | 12665GR | 2 | \$160.00 |
| Foam Cell - Performance | | | 24665FE | 2 | \$232.00 |

COIL SPRINGS

| | Est. Lift | Additional Load | | | |
|--------|-----------|-----------------|-----------------|---|----------|
| Medium | 45mm | 0 - 100kg | JEEP016B | 1 | \$262.00 |

STEERING DAMPER

| | | | | | |
|-----------|--|--|-------------|---|----------|
| Foam Cell | | | 3540 | 1 | \$175.00 |
|-----------|--|--|-------------|---|----------|

REAR SUSPENSION

SHOCK ABSORBER

| | | | | | |
|-------------------------|--|--|----------------|---|----------|
| Nitro Gas - Performance | | | 12666GR | 2 | \$160.00 |
| Foam Cell - Performance | | | 24666FE | 2 | \$232.00 |

LEAF SPRINGS

| | Est. Lift | Additional Load | | | |
|-----------------------|-----------|-----------------|--------------------|---|----------|
| Medium - Drivers Side | 45mm | 0 - 250kg | JEEP004BD/S | 1 | \$421.00 |
| Medium - Near Side | 45mm | 0 - 250kg | JEEP004BN/S | 1 | \$421.00 |

• In some cases a driveline vibration may occur after lift, a gearbox crossmember spacer may be required

U-BOLTS

| | | | | | |
|------------|--|--|---------------|---|---------|
| U-Bolt Kit | | | 512UBK | 2 | \$44.00 |
|------------|--|--|---------------|---|---------|

POLYURETHANE SPRING BUSHES

| | | | | | |
|----------|--|--|--------------|---|----------|
| Bush Kit | | | 762UK | 1 | \$175.00 |
|----------|--|--|--------------|---|----------|

SUSPENSION KIT

| | | | | | |
|--------------------|--|--|-------------------|--|-----------|
| Medium - Nitro Gas | | | JEEP003BKG | | \$1999.00 |
| Medium - Foam Cell | | | JEEP003BKF | | \$2288.00 |

• In some cases a driveline vibration may occur after lift, a gearbox crossmember spacer may be required

SUSPENSION KIT CONTENTS

| | | |
|-----------------|--------------|----------------------------|
| Shock Absorbers | Coil Springs | Polyurethane Spring Bushes |
| Leaf Springs | U-Bolts | |



Jeep Gladiator

JT
4/2019+

Product Description

Part No.

Qty
ReqRetail
ea Inc GST

Please check vehicle date range (if shown) next to product description prior to ordering

ACCESSORIES TO SUIT JEEP GLADIATOR - 4/2019+

STEEL WINCH BULL BARS

| | | | |
|-------------------------------------|-----------------|--|-----------|
| Raid Full Length Steel Bumper | BBR077 | | \$1489.00 |
| Raid Stubby Bumper* | BBR077ST | | - |
| Driving Light / Lightbar Patch Loom | IPL077 | | \$38.00 |

* Stubby Bull Bar is non-compliant to Australian regulations therefore not available in Australia

• Raid Bull Bars are compatible with Ironman 4x4 Lightbars and Cube Lights, refer below for available options

LIGHTING OPTIONS - TO SUIT RAID BULL BARS

| | | | |
|--|------------------|---|----------|
| 105W Bright Sabre-X Single Row Slim Lightbar 522mm (20") Straight | ILBSR003B | 1 | \$220.00 |
| 40W Bright Cube Spot Beam LED Cube Light - 81 x 75mm (Each) - Clear | ILED80B | 2 | \$83.00 |
| 40W Bright Cube Spot Beam LED Cube Light - 81 x 75mm (Each) - Amber | ILED80BA | 2 | \$83.00 |
| 40W Bright Cube Flood Beam LED Cube Light - 81 x 75mm (Each) - Clear | ILED80BF | 2 | \$83.00 |
| 40W Bright Cube Flood Beam LED Cube Light - 81 x 75mm (Each) - Amber | ILED80BFA | 2 | \$83.00 |

STEEL SIDE STEPS

| | | | |
|-------------------|----------------|--|-----------|
| Raid Rock Sliders | SS077JT | | \$1003.00 |
|-------------------|----------------|--|-----------|

REAR PROTECTION

| | | | |
|---------------------------|------------------|--|-----------|
| Raid Steel Rear Bumper* | RTB077JT | | \$1103.00 |
| Rear OEM Light Pod Holder | RJTHOLDER | | \$85.00 |

* Not compatible with Rubicon rear corner steps

• Compatible with Ironman 4x4 Cube Lights, refer below for available options

LIGHTING OPTIONS - TO SUIT RAID REAR BARS

| | | | |
|--|------------------|---|---------|
| 20W Bright Cube Spot Beam LED Cube Light - 70 x 64mm (Each) - Clear | ILED20B | 2 | \$62.00 |
| 20W Bright Cube Spot Beam LED Cube Light - 70 x 64mm (Each) - Amber | ILED20BA | 2 | \$62.00 |
| 20W Bright Cube Flood Beam LED Cube Light - 70 x 64mm (Each) - Clear | ILED20BF | 2 | \$62.00 |
| 20W Bright Cube Flood Beam LED Cube Light - 70 x 64mm (Each) - Amber | ILED20BFA | 2 | \$62.00 |
| 20W Bright Cube Flood Beam LED Cube Light - 70 x 64mm (Each) - Red | ILED20BFR | 2 | \$62.00 |

SLIDE-AWAY ROLL UP HARD TONNEAU COVER

| | | | |
|---|------------------------|--|-----------|
| Electric with Remote Control - Requires 'Trail Rail' system to be fitted for installation | ISLIDEAWAY077-E | | \$2716.00 |
|---|------------------------|--|-----------|

ATLAS ROOF RACK KITS

| | | | |
|--|----------------------|--|-----------|
| Platform S with Blade Fit Kit to Suit Slideaway Hard Tonneau Cover - 1390mm Length | IFRSLDAWAYPSK | | \$1670.00 |
| Crossbar (x 2) and Fit Kit (Dual Cab) - 1650mm Width | IFR077C2K | | \$523.00 |
| Crossbar (x 2) and Fit Kit to Suit Slideaway Hard Tonneau Cover - 1500mm Width | IFRSLDAWAYC2K | | \$940.00 |

• See Page 36 and 37 for more Atlas rack and crossbar options.

BREATHER KIT

| | | | |
|---|-----------------|--|----------|
| Universal Twin Manifold Filtered Breather Kit | IDIFFBRE | | \$115.00 |
|---|-----------------|--|----------|



Jeep Gladiator



JT
4/2019+

Product Description

Part No.

Qty
ReqRetail
ea Inc GST

Please check vehicle date range (if shown) next to product description prior to ordering

SUSPENSION TO SUIT JEEP GLADIATOR - 4/2019+

FRONT SUSPENSION

SHOCK ABSORBER

| | | | | | |
|-----------------------------|--|--|-----------------|---|----------|
| Nitro Gas - Comfort | | | 12851GRC | 2 | \$160.00 |
| Nitro Gas - Performance | | | 12851GR | 2 | \$160.00 |
| Foam Cell Pro - Comfort | | | 45851FEC | 2 | \$319.00 |
| Foam Cell Pro - Performance | | | 45851FE | 2 | \$319.00 |

COIL SPRINGS

| | Est. Lift | Additional Load | | | |
|--------|-----------|-----------------|-----------------|---|----------|
| Medium | 50mm | 0 - 60kg | JEEP031B | 1 | \$262.00 |

STEERING DAMPER

| | | | | | |
|-----------|--|------------------|-------------|---|----------|
| Foam Cell | | Left Hand Drive | 3544 | 1 | \$175.00 |
| Foam Cell | | Right Hand Drive | 3543 | 1 | \$175.00 |

REAR SUSPENSION

SHOCK ABSORBER

| | | | | | |
|-----------------------------|--|--|-----------------|---|----------|
| Foam Cell Pro - Comfort | | | 45854FEC | 2 | \$319.00 |
| Foam Cell Pro - Performance | | | 45854FE | 2 | \$319.00 |

COIL SPRINGS

| | Est. Lift | Additional Load | | | |
|-------------|-----------|-----------------|-----------------|---|----------|
| Medium | 50mm | 0 - 300kg | JEEP032B | 1 | \$262.00 |
| Heavy | 50mm | 300kg - 600kg | JEEP032C | 1 | \$262.00 |
| Extra Heavy | 50mm | 600kg - GVM | JEEP032D | 1 | \$262.00 |

SUSPENSION KIT

| | | | | | |
|-----------------------------|--|--|-------------------|---|-----------|
| Medium - Foam Cell Pro | | | JEEP032BKP | 1 | \$1796.00 |
| Heavy - Foam Cell Pro | | | JEEP032CKP | 1 | \$1796.00 |
| Extra Heavy - Foam Cell Pro | | | JEEP032DKP | 1 | \$1796.00 |

SUSPENSION KIT CONTENTS

Shock Absorbers

Coil Springs

Jeep Grand Cherokee

WK2
8/2013+



Product Description

Part No.

Qty
Req

Retail
ea Inc GST

Please check vehicle date range (if shown) next to product description prior to ordering

ACCESSORIES TO SUIT JEEP GRAND CHEROKEE - 8/2013+

| Product Description | Part No. | Qty Req | Retail ea Inc GST |
|--|----------|---------|-------------------|
| STEEL WINCH BULL BARS - ONLY FITS DIESEL LAREDO WITHOUT QUADRA-LIFT SUSPENSION (NO SENSOR HOLES PRE-DRILLED) Commercial Deluxe • Does not suit vehicles with forward facing radar | BBCD052 | | \$2345.00 |
| BREATHER KIT Universal Twin Manifold Filtered Breather Kit | IDIFFBRE | | \$115.00 |



(4x4) WK2
2011+

Jeep Grand Cherokee

Product Description

Part No.

Qty
ReqRetail
ea Inc GST*Please check vehicle date range (if shown) next to product description prior to ordering***SUSPENSION TO SUIT JEEP GRAND CHEROKEE - 2011+****FRONT SUSPENSION****SHOCK ABSORBER**

| | | | | |
|-------------------------|--------------------------------------|---------------------|---|----------|
| Nitro Gas - Performance | 2011-2016 (Without Sway Bar Bracket) | 12735GR | 2 | \$262.00 |
| Nitro Gas - Performance | 2016 + (With Sway Bar Bracket) | 12738GRLH/RH | 2 | \$262.00 |

- 2016+ vehicles have sway bar bracket attached to lower clevis.

STRUT MOUNTS

| | | | | |
|-----------------|--|----------------|---|----------|
| Steel Strut Top | | ISST052 | 2 | \$116.00 |
|-----------------|--|----------------|---|----------|

COIL SPRINGS

| | Est. Lift | Additional Load | | |
|-----------------|-----------|-----------------|-----------------|---|
| Medium | 40mm | 0 - 50kg | JEEP025B | 1 |
| Heavy or Diesel | 40mm | 50 - 100kg | JEEP025C | 1 |

REAR SUSPENSION**SPACER KIT**

| | | | | |
|-----------------------|--|--------------|---|----------|
| Shock Absorber Spacer | | 1202K | 1 | \$102.00 |
|-----------------------|--|--------------|---|----------|

- No rear shock absorbers available due to Nivomat Shock Absorbers and the affect on vehicle tow rating. 1202K is used to space shock absorber mount to accommodate lift.

COIL SPRINGS

| | Est. Lift | Additional Load | | |
|--------|-----------|-----------------|-----------------|---|
| Medium | 40mm | 0 - 300kg | JEEP026B | 1 |
| Heavy | 40mm | 300 - 600kg | JEEP026C | 1 |

- Nivomat self-levelling rear shock absorber equipped models only. Nivomat shock absorber has a 63mm body size.

Not compatible with 51mm standard shock absorber body.

SUSPENSION KIT

| | | |
|--------------------|-------------------|-----------|
| Medium - Nitro Gas | JEEP025BKG | \$1145.00 |
| Heavy - Nitro Gas | JEEP025CKG | \$1145.00 |

- Vehicles with monocoque body construction can be subject to increased NVH (Noise) with upgraded suspension installed.

SUSPENSION KIT CONTENTS

Strut Shock Absorbers Shock Absorber Spacers Coil Springs

Jeep Grand Cherokee

WJ / WG
1999 to 6/2005



Product Description

Part No.

Qty
Req

Retail
ea Inc GST

Please check vehicle date range (if shown) next to product description prior to ordering

SUSPENSION TO SUIT JEEP GRAND CHEROKEE - 1999-6/2005

FRONT SUSPENSION

SHOCK ABSORBER

Nitro Gas - Performance

12774GR 2 \$160.00

COIL SPRINGS

Est. Lift Additional Load

Medium 40mm 0 - 50kg **JEEP012B** 1 \$262.00

Heavy 40mm 50 - 100kg **JEEP012C** 1 \$262.00

REAR SUSPENSION

SHOCK ABSORBER

Nitro Gas - Performance

12775GR 2 \$160.00

COIL SPRINGS

Est. Lift Additional Load

Medium 40mm 0 - 200kg **JEEP013B** 1 \$262.00

Heavy 40mm 200kg - GVM **JEEP013C** 1 \$262.00

SUSPENSION KIT

Medium - Nitro Gas

JEEP012BKG \$1159.00

• Vehicles with monocoque body construction can be subject to increased NVH (Noise) with upgraded suspension installed

SUSPENSION KIT CONTENTS

Shock Absorbers

Coil Springs



ZJ/ZG
1993 to 1998

Jeep Grand Cherokee

Product Description

Part No.

Qty
Req

Retail
ea Inc GST

Please check vehicle date range (if shown) next to product description prior to ordering

SUSPENSION TO SUIT JEEP GRAND CHEROKEE - 1993-1998

FRONT SUSPENSION

SHOCK ABSORBER

| | | | | | |
|-------------------------|--|--|----------------|---|----------|
| Nitro Gas - Performance | | | 12665GR | 2 | \$160.00 |
| Foam Cell - Performance | | | 24665FE | 2 | \$232.00 |

COIL SPRINGS

| | Est. Lift | Additional Load | | | |
|--------|-----------|-----------------|-----------------|---|----------|
| Medium | 40mm | 0 - 50kg | JEEP003B | 1 | \$262.00 |
| Heavy | 40mm | 50 - 100kg | JEEP016B | 1 | \$262.00 |

STEERING DAMPER

| | | | | | |
|-----------|--|--|-------------|---|----------|
| Foam Cell | | | 3540 | 1 | \$175.00 |
|-----------|--|--|-------------|---|----------|

REAR SUSPENSION

SHOCK ABSORBER

| | | | | | |
|-------------------------|--|--|----------------|---|----------|
| Nitro Gas - Performance | | | 12670GR | 2 | \$160.00 |
|-------------------------|--|--|----------------|---|----------|

COIL SPRINGS

| | Est. Lift | Additional Load | | | |
|--------|-----------|-----------------|-----------------|---|----------|
| Medium | 40mm | 0 - 300kg | JEEP006B | 1 | \$262.00 |
| Heavy | 40mm | 300kg - GVM | JEEP003B | 1 | \$262.00 |

SUSPENSION KIT - Specify Front Coil Springs When Ordering

| | | |
|--------------------|-------------------|-----------|
| Medium - Nitro Gas | JEEP006BKG | \$1159.00 |
| Heavy - Nitro Gas | JEEP006CKG | \$1159.00 |

• Vehicles with monocoque body construction can be subject to increased NVH (Noise) with upgraded suspension installed

SUSPENSION KIT CONTENTS

Shock Absorbers Coil Springs



Jeep Wrangler

JL
2018+

Product Description

Part No.

Qty
ReqRetail
ea Inc GST

Please check vehicle date range (if shown) next to product description prior to ordering

ACCESSORIES TO SUIT JEEP WRANGLER - 2018+

STEEL WINCH BULL BARS

| | | | |
|-------------------------------------|-----------------|--|-----------|
| Raid Full Length Steel Bumper | BBR077 | | \$1489.00 |
| Raid Stubby Bumper* | BBR077ST | | - |
| Driving Light / Lightbar Patch Loom | IPL077 | | \$38.00 |

* Stubby Bull Bar is non-compliant to Australian regulations therefore not available in Australia

• Raid Bull Bars are compatible with Ironman 4x4 Lightbars and Cube Lights, refer below for available options

LIGHTING OPTIONS - TO SUIT RAID BULL BARS

| | | | |
|--|------------------|---|----------|
| 105W Bright Sabre-X Single Row Slim Lightbar 522mm (20") Straight | ILBSR003B | 1 | \$220.00 |
| 40W Bright Cube Spot Beam LED Cube Light - 81 x 75mm (Each) - Clear | ILED80B | 2 | \$83.00 |
| 40W Bright Cube Spot Beam LED Cube Light - 81 x 75mm (Each) - Amber | ILED80BA | 2 | \$83.00 |
| 40W Bright Cube Flood Beam LED Cube Light - 81 x 75mm (Each) - Clear | ILED80BF | 2 | \$83.00 |
| 40W Bright Cube Flood Beam LED Cube Light - 81 x 75mm (Each) - Amber | ILED80BFA | 2 | \$83.00 |

STEEL SIDE STEPS

| | | | |
|-------------------|----------------|--|-----------|
| Raid Rock Sliders | SS077JL | | \$1003.00 |
|-------------------|----------------|--|-----------|

• 4 Door models only

REAR PROTECTION AND TOWING

| | | | |
|---|-----------------|--|-----------|
| Raid Steel Rear Bumper* | RTB077JL | | \$1103.00 |
| Class 3 Tow Bar (3500lb) | TB077JL | | \$183.00 |
| Spare Tyre and Licence Plate Relocation Kit † | RWC077JL | | \$336.00 |

† Compatible up to 37" tyres

* Recommend installation of RWC077JL to raise spare wheel and licence plate relocation

• Compatible with Ironman 4x4 Cube Lights, refer below for available options

LIGHTING OPTIONS - TO SUIT RAID REAR BARS

| | | | |
|--|------------------|---|---------|
| 20W Bright Cube Spot Beam LED Cube Light - 70 x 64mm (Each) - Clear | ILED20B | 2 | \$62.00 |
| 20W Bright Cube Spot Beam LED Cube Light - 70 x 64mm (Each) - Amber | ILED20BA | 2 | \$62.00 |
| 20W Bright Cube Flood Beam LED Cube Light - 70 x 64mm (Each) - Clear | ILED20BF | 2 | \$62.00 |
| 20W Bright Cube Flood Beam LED Cube Light - 70 x 64mm (Each) - Amber | ILED20BFA | 2 | \$62.00 |
| 20W Bright Cube Flood Beam LED Cube Light - 70 x 64mm (Each) - Red | ILED20BFR | 2 | \$62.00 |



Jeep Wrangler

JL
Includes 4xe Models
2018+

Product Description

Part No.

Qty
ReqRetail
ea Inc GST

Please check vehicle date range (if shown) next to product description prior to ordering

SUSPENSION TO SUIT JEEP WRANGLER - 2018+

FRONT SUSPENSION

SHOCK ABSORBER

| | | | | | |
|-----------------------------|---------------|--|------------------|---|----------|
| Nitro Gas - Comfort | | | 12851GRC | 2 | \$160.00 |
| Nitro Gas - Comfort | Suits 4" Lift | | 12851LGRC | 2 | \$160.00 |
| Nitro Gas - Performance | | | 12851GR | 2 | \$160.00 |
| Nitro Gas - Performance | Suits 4" Lift | | 12851LGR | 2 | \$160.00 |
| Foam Cell Pro - Comfort | | | 45851FEC | 2 | \$319.00 |
| Foam Cell Pro - Comfort | Suits 4" Lift | | 45851LFEC | 2 | \$319.00 |
| Foam Cell Pro - Performance | | | 45851FE | 2 | \$319.00 |
| Foam Cell Pro - Performance | Suits 4" Lift | | 45851LFE | 2 | \$319.00 |

COIL SPRINGS

| | Est. Lift | Additional Load | | | |
|--------|-----------|-----------------|-----------------|---|----------|
| Light | 45mm | 0 - 50kg | JEEP029A | 1 | \$262.00 |
| Medium | 50mm | 0 - 50kg | JEEP029B | 1 | \$262.00 |
| Medium | 100mm | 0 - 50kg | JEEP035B | 1 | \$291.00 |
| Heavy | 50mm | 50 - 100kg | JEEP029C | 1 | \$262.00 |

*Estimated lift 1" (25mm) less in US Rubicon models

STEERING DAMPER

| | | | | |
|----------------------|------------------|-------------|---|----------|
| Foam Cell - Pre 2022 | Left Hand Drive | 3544 | 1 | \$175.00 |
| Foam Cell - Pre 2022 | Right Hand Drive | 3543 | 1 | \$175.00 |

BUMP STOP

| | | | | |
|----------------------------|---------------|--------------|---|---------|
| Front Bump Stop Spacer Kit | Suits 4" Lift | 1235K | 1 | \$76.00 |
|----------------------------|---------------|--------------|---|---------|

SWAY BAR LINK

| | | | | |
|------------------------|---------------|-----------------|---|----------|
| Extended Sway Bar Link | Suits 4" Lift | SBEXT035 | 1 | \$120.00 |
|------------------------|---------------|-----------------|---|----------|

REAR SUSPENSION

SHOCK ABSORBER

| | | | | | |
|-----------------------------|---------------|--|------------------|---|----------|
| Nitro Gas - Comfort | | | 12852GRC | 2 | \$160.00 |
| Nitro Gas - Comfort | Suits 4" Lift | | 12852LGRC | 2 | \$160.00 |
| Nitro Gas - Performance | | | 12852GR | 2 | \$160.00 |
| Nitro Gas - Performance | Suits 4" Lift | | 12852LGR | 2 | \$160.00 |
| Foam Cell Pro - Comfort | | | 45852FEC | 2 | \$319.00 |
| Foam Cell Pro - Comfort | Suits 4" Lift | | 45852LFEC | 2 | \$319.00 |
| Foam Cell Pro - Performance | | | 45852FE | 2 | \$319.00 |
| Foam Cell Pro - Performance | Suits 4" Lift | | 45852LFE | 2 | \$319.00 |

COIL SPRINGS

| | Est. Lift | Additional Load | | | |
|-------------------------|-----------|-----------------|-----------------|---|----------|
| Light - (2 Door Models) | 45mm | 0 - 100kg | JEEP030A | 1 | \$262.00 |
| Medium | 50mm | 0 - 250kg | JEEP030B | 1 | \$262.00 |
| Medium | 100mm | 0 - 50kg | JEEP035B | 1 | \$291.00 |
| Heavy | 50mm | 200kg - GVM | JEEP030C | 1 | \$262.00 |

BUMP STOP

| | | | | |
|---------------------------|---------------|--------------|---|---------|
| Rear Bump Stop Spacer Kit | Suits 4" Lift | 1236K | 1 | \$76.00 |
|---------------------------|---------------|--------------|---|---------|

SWAY BAR LINK

| | | | | |
|------------------------|---------------|-----------------|---|----------|
| Extended Sway Bar Link | Suits 4" Lift | SBEXT036 | 1 | \$120.00 |
|------------------------|---------------|-----------------|---|----------|

BRACKET KITS

| | | | | |
|--------------------------|---------------|-----------------|---|----------|
| Rear Panhard Bracket Kit | Suits 4" Lift | PDB036R | 1 | \$85.00 |
| 4" Lift Bracket Set* | Suits 4" Lift | JLKIT035 | 1 | \$461.00 |

* Bracket set contains 1 x 1235K, 1 x 1236K, 1 x SBEXT035, 1 x SBEXT036 and 1 x PDB036R

SUSPENSION KIT - Specify Front Coil Springs When Ordering

| | | | | |
|------------------------|---------------|--------------------|---|-----------|
| Light - Nitro Gas | | JEEP030AKG | 1 | \$1159.00 |
| Light - Foam Cell Pro | | JEEP030AKP | 1 | \$1796.00 |
| Medium - Nitro Gas | | JEEP030BKG | 1 | \$1159.00 |
| Medium - Nitro Gas | Suits 4" Lift | JEEP035BKGL | 1 | \$1683.00 |
| Medium - Foam Cell Pro | | JEEP030BKP | 1 | \$1796.00 |
| Medium - Foam Cell Pro | Suits 4" Lift | JEEP035BKPL | 1 | \$2319.00 |
| Heavy - Nitro Gas | | JEEP030CKG | 1 | \$1159.00 |
| Heavy - Foam Cell Pro | | JEEP030CKP | 1 | \$1796.00 |

SUSPENSION KIT CONTENTS

Shock Absorbers

Coil Springs

4" SUSPENSION KIT CONTENTS

Shock Absorbers

Coil Springs

4" Bracket Set

Jeep Wrangler

JK
2007+



Product Description

Part No.

Qty
Req

Retail
ea Inc GST

Please check vehicle date range (if shown) next to product description prior to ordering

ACCESSORIES TO SUIT JEEP WRANGLER - 2007+

STEEL WINCH BULL BARS - MUST USE OE FOG LIGHTS

Commercial Deluxe

BBCD035

\$2345.00

SNORKEL

Not Available in Australia

ISNORKE032

\$380.00

BREATHER KIT

Universal Twin Manifold Filtered Breather Kit

IDIFFBRE

\$115.00

Jeep Wrangler

JK
2006+

Product Description

Part No.

Qty
ReqRetail
ea Inc GST*Please check vehicle date range (if shown) next to product description prior to ordering***SUSPENSION TO SUIT JEEP WRANGLER - 2006+****FRONT SUSPENSION****SHOCK ABSORBER**

| | | | | | |
|-----------------------------|---------------|--|-----------------|---|----------|
| Nitro Gas - Performance | | | 12751GR | 2 | \$160.00 |
| Nitro Gas - Performance | Suits 4" Lift | | 12751LGR | 2 | \$160.00 |
| Foam Cell Pro - Performance | | | 45751FE | 2 | \$319.00 |
| Foam Cell Pro - Performance | Suits 4" Lift | | 45751LFE | 2 | \$334.00 |

COIL SPRINGS

| | Est. Lift | Additional Load | | | |
|------------------|-----------|-----------------|-----------------|---|----------|
| Medium | 40mm | 0 - 50kg | JEEP017B | 1 | \$262.00 |
| Medium - 4" Lift | 100mm | 0 - 50kg | JEEP019B | 1 | \$305.00 |
| Heavy | 40mm | 50 - 110kg | JEEP017C | 1 | \$262.00 |

STEERING DAMPER

| | | | | |
|-----------|--------------------------|-------------|---|----------|
| Foam Cell | Regular Fitment | 3541 | 1 | \$175.00 |
| Foam Cell | Suits JKBKTL 4" Kit Only | 3540 | 1 | \$175.00 |

PANHARD ROD

| | | | | |
|------------------------|--|-------------------|---|----------|
| Adjustable Panhard Rod | | PANHARD010 | 1 | \$334.00 |
|------------------------|--|-------------------|---|----------|

REAR SUSPENSION**SHOCK ABSORBER**

| | | | | | |
|-----------------------------|---------------|--|-----------------|---|----------|
| Nitro Gas - Performance | | | 12752GR | 2 | \$160.00 |
| Nitro Gas - Performance | Suits 4" Lift | | 12752LGR | 2 | \$160.00 |
| Foam Cell Pro - Performance | | | 45752FE | 2 | \$319.00 |
| Foam Cell Pro - Performance | Suits 4" Lift | | 45752LFE | 2 | \$334.00 |

COIL SPRINGS

| | Est. Lift | Additional Load | | | |
|------------------|-----------|-----------------|-----------------|---|----------|
| Medium - 2 Door | 40mm | 0 - 250kg | JEEP018A | 1 | \$262.00 |
| Medium - 4 Door | 40mm | 0 - 250kg | JEEP018B | 1 | \$262.00 |
| Medium - 4" Lift | 100mm | 0 - 250kg | JEEP020B | 1 | \$305.00 |

PANHARD ROD

| | | | | |
|------------------------|--|-------------------|---|----------|
| Adjustable Panhard Rod | | PANHARD011 | 1 | \$334.00 |
|------------------------|--|-------------------|---|----------|

SWAY BAR LINK

| | | | | |
|------------------------|--|-----------------|---|---------|
| Extended Sway Bar Link | | SBEXT008 | 2 | \$88.00 |
|------------------------|--|-----------------|---|---------|

- OEM Rear Links can be moved to the front of vehicle.

BRACKET KIT

| | | | | |
|---------------------|-----------------------------|----------------|---|-----------|
| 4" Lift Bracket Set | Left Hand Drive Models ONLY | JKBKITL | 1 | \$2013.00 |
|---------------------|-----------------------------|----------------|---|-----------|

- Bracket set is sold complete. Parts are not available individually

SUSPENSION KIT - Specify Front Coil Springs When Ordering

| | | | |
|------------------------|---------|--------------------|-----------|
| Light - Nitro Gas | 2 Door | JEEP017AKG | \$1159.00 |
| Light - Foam Cell Pro | 2 Door | JEEP017AKP | \$1796.00 |
| Medium - Nitro Gas | 4 Door | JEEP017BKG | \$1159.00 |
| Medium - Nitro Gas | 4" Lift | JEEP019BKGL | \$3431.00 |
| Medium - Foam Cell Pro | 4 Door | JEEP017BKP | \$1796.00 |
| Medium - Foam Cell Pro | 4" Lift | JEEP019BKPL | \$4126.00 |

- 4" Lift may not be legal for road use in your area. Certification may be required for on-road use

- 4" Lift Kit suits left hand drive models ONLY

- 4" Lift components should only be used together with appropriate geometry correction components

SUSPENSION KIT CONTENTS

Shock Absorbers Coil Springs

4" SUSPENSION KIT CONTENTSShock Absorbers Steering Damper
Coil Springs 4" Bracket Set**4" BRACKET SET CONTENTS**

Steering Rod Flip Kit - JKBK01L

Front Shock Absorber Relocation Kit - JKBK02

Radius Arm Relocation Kit - JKBK03

Brake Hose Extension Kit - JKBK04

Front Adjustable Panhard Rod - PANHARD010

- Fitment to RHD is possible with omission of JKBK01L and JKBK05L

Rear Adjustable Panhard Rod - PANHARD012

Rear Panhard Rod Relocation Kit - JKBK05L

Bump Stop Spacer Kit - JKBK06

Adjustable Swaybar Extensions - SBEXT008

Jeep Wrangler

TJ
1996 to 2/2007



Product Description

Part No.

Qty
Req

Retail
ea Inc GST

Please check vehicle date range (if shown) next to product description prior to ordering

SUSPENSION TO SUIT JEEP WRANGLER - 1996-2/2007

FRONT SUSPENSION

SHOCK ABSORBER

| | | | | | |
|-------------------------|--|--|----------------|---|----------|
| Nitro Gas - Performance | | | 12665GR | 2 | \$160.00 |
| Foam Cell - Performance | | | 24665FE | 2 | \$232.00 |

COIL SPRINGS

| | Est. Lift | Additional Load | | | |
|--------|-----------|-----------------|-----------------|---|----------|
| Medium | 40mm | 0 - 40kg | JEEP007B | 1 | \$262.00 |
| Heavy | 40mm | 40 - 80kg | JEEP003B | 1 | \$262.00 |

STEERING DAMPER

| | | | | | |
|-----------|--|--|-------------|---|----------|
| Foam Cell | | | 3540 | 1 | \$175.00 |
|-----------|--|--|-------------|---|----------|

REAR SUSPENSION

SHOCK ABSORBER

| | | | | | |
|-------------------------|--|--|----------------|---|----------|
| Nitro Gas - Performance | | | 12669GR | 2 | \$160.00 |
|-------------------------|--|--|----------------|---|----------|

COIL SPRINGS

| | Est. Lift | Additional Load | | | |
|--------|-----------|-----------------|-----------------|---|----------|
| Medium | 40mm | 0 - 200kg | JEEP008B | 1 | \$262.00 |

• In some cases a driveline vibration may occur after lift, a gearbox crossmember spacer may be required

SUSPENSION KIT - Specify Front Coil Springs When Ordering

| | | | | | |
|--------------------|--|--|-------------------|--|-----------|
| Medium - Nitro Gas | | | JEEP007BKG | | \$1159.00 |
|--------------------|--|--|-------------------|--|-----------|

• In some cases a driveline vibration may occur after lift, a gearbox crossmember spacer may be required

SUSPENSION KIT CONTENTS

Shock Absorbers Coil Springs



2014+

| Product Description | Part No. | Qty Req | Retail ea Inc GST |
|---------------------|----------|---------|-------------------|
|---------------------|----------|---------|-------------------|

Please check vehicle date range (if shown) next to product description prior to ordering

SUSPENSION TO SUIT JMC VIGUS - 2014+

FRONT SUSPENSION

SHOCK ABSORBER

| | | | | |
|-----------------------------------|--|----------------|---|----------|
| Nitro Gas Strut - Performance | | 12710GR | 2 | \$232.00 |
| Foam Cell Strut - Performance | | 24710FE | 2 | \$262.00 |
| Foam Cell Pro Strut - Performance | | 45710FE | 2 | \$406.00 |

COIL SPRINGS

| | Est. Lift | Additional Load | | | |
|--------|-----------|-----------------|----------------|---|----------|
| Medium | 45mm | 0 - 50kg | TOY038C | 1 | \$262.00 |
| Heavy | 45mm | 50 - 110kg | TOY055A | 1 | \$262.00 |

STRUT MOUNTS

| | | | | |
|-----------------|--|----------------|---|---------|
| Steel Strut Top | | ISST001 | 2 | \$88.00 |
|-----------------|--|----------------|---|---------|

TRIM PACKERS

| | | | | |
|------------------------|-----------------------|-------------------------|---|---------|
| 5mm Strut Trim Packer | Nitro Gas / Foam Cell | HILFR05/HILFR05F | 2 | \$30.00 |
| 10mm Strut Trim Packer | Nitro Gas / Foam Cell | HILFR10/HILFR10F | 2 | \$30.00 |
| 15mm Strut Trim Packer | Nitro Gas / Foam Cell | HILFR15/HILFR15F | 2 | \$30.00 |

• ONLY Compatible with Ironman 4x4 Struts (except Pro), lift height subject to 2:1 motion ratio. Unnecessary fitment may lift vehicle too high

REAR SUSPENSION

SHOCK ABSORBER

| | | | | |
|------------------------------|--|-----------------|---|----------|
| Nitro Gas - Comfort | | 12650GRC | 2 | \$160.00 |
| Nitro Gas - Performance | | 12650GR | 2 | \$160.00 |
| Foam Cell - Comfort | | 24650FEC | 2 | \$232.00 |
| Foam Cell - Performance | | 24650FE | 2 | \$232.00 |
| Foam Cell - Professional | | 24650FEP | 2 | \$232.00 |
| Foam Cell Pro - Comfort | | 45650FEC | 2 | \$319.00 |
| Foam Cell Pro - Performance | | 45650FE | 2 | \$319.00 |
| Foam Cell Pro - Professional | | 45650FEP | 2 | \$319.00 |

LEAF SPRINGS

| | Est. Lift | Additional Load | | | |
|--------|-----------|-----------------|----------------|---|----------|
| Medium | 40mm | 0 - 200kg | JMC002B | 2 | \$392.00 |
| Heavy | 40mm | 200 - 400kg | JMC002C | 2 | \$421.00 |

U-BOLTS

| | | | | |
|------------|--|----------------|---|---------|
| U-Bolt Kit | | 437UBKL | 2 | \$44.00 |
|------------|--|----------------|---|---------|

POLYURETHANE SPRING BUSHES

| | | | | |
|----------|--|--------------|---|---------|
| Bush Kit | | 767UK | 1 | \$88.00 |
|----------|--|--------------|---|---------|

GREASABLE SHACKLES AND PINS

| | | | | |
|-------------------|--|--------------|---|---------|
| Greasable Shackle | | 386-3 | 2 | \$59.00 |
| Non-Greasable Pin | | 387-1 | 2 | \$30.00 |

HELPER SPRINGS

| | | | | |
|--------------------------|--|----------------|---|----------|
| Load Plus Helper Springs | | LP2 | 1 | \$165.00 |
| Add-A-Leaf | | ISL6010 | 1 | \$175.00 |

SUSPENSION KIT - Specify Front Coil Springs When Ordering

| | | |
|------------------------|------------------|-----------|
| Medium - Nitro Gas | JMC002BKG | \$1999.00 |
| Medium - Foam Cell | JMC002BKF | \$2201.00 |
| Medium - Foam Cell Pro | JMC002BKP | \$2664.00 |
| Heavy - Nitro Gas | JMC002CKG | \$2056.00 |
| Heavy - Foam Cell | JMC002CKF | \$2259.00 |
| Heavy - Foam Cell Pro | JMC002CKP | \$2723.00 |

SUSPENSION KIT CONTENTS

| | | |
|-----------------------|--------------|----------------------------|
| Shock Absorbers | Coil Springs | U-Bolts |
| Strut Shock Absorbers | Leaf Springs | Polyurethane Spring Bushes |

Kia Sorento

BL
2003 to 2008



Product Description

Part No.

Qty
Req

Retail
ea Inc GST

Please check vehicle date range (if shown) next to product description prior to ordering

SUSPENSION TO SUIT KIA SORENTO - 2003-2008

FRONT SUSPENSION

COIL SPRINGS

| | Est. Lift | Additional Load | Part No. | Qty | Retail Price |
|--------|-----------|-----------------|----------------|-----|--------------|
| Medium | 35mm | 0 - 50kg | KIA006B | 1 | \$262.00 |

REAR SUSPENSION

COIL SPRINGS

| | Est. Lift | Additional Load | Part No. | Qty | Retail Price |
|--------|-----------|-----------------|----------------|-----|--------------|
| Medium | 35mm | 0 - 200kg | KIA007B | 1 | \$262.00 |





1978+

Lada Niva

Product Description

Part No.

Qty
Req

Retail
ea Inc GST

Please check vehicle date range (if shown) next to product description prior to ordering

SUSPENSION TO SUIT LADA NIVA - 1978+

FRONT SUSPENSION

COIL SPRINGS

| | Est. Lift | Additional Load | Part No. | Qty | Retail Price |
|--------|-----------|-----------------|----------|-----|--------------|
| Medium | 35mm | 0 - 50kg | LADA001B | 1 | \$262.00 |

REAR SUSPENSION

COIL SPRINGS

| | Est. Lift | Additional Load | Part No. | Qty | Retail Price |
|--------|-----------|-----------------|----------|-----|--------------|
| Medium | 35mm | 0 - 200kg | LADA002B | 1 | \$262.00 |



Alu-Cab™

ULTIMATE OVERLAND PRODUCTS



ICARUS
Roof conversion
to Suit Defender 110

for a full range of alu-cab visit our website

www.alu-cab.com.au

distributed by





2007 to 2016

Land Rover Defender

Product Description

Part No.

Qty
ReqRetail
ea Inc GST

Please check vehicle date range (if shown) next to product description prior to ordering

ACCESSORIES TO SUIT LAND ROVER DEFENDER - 2007-2016

LOCKSAFE DRAWER SYSTEMS

| | | |
|------------------------|---------|-----------|
| Twin Drawers - 1000mm | ITD1000 | \$1355.00 |
| Single Drawer - 1000mm | ISD1000 | \$820.00 |

STEEL ROOF RACKS

| | | |
|--|------------|----------|
| Cage Style - 1.4m x 1.25m | IRRCAGE14 | \$812.00 |
| Cage Style - 1.8m x 1.25m | IRRCAGE18 | \$852.00 |
| Cage Style - 2.2m x 1.25m | IRRCAGE22 | \$885.00 |
| Rooftop Tent Compatible - 1.8m x 1.25m | IRRTENT18 | \$812.00 |
| Rooftop Tent Compatible - 2.2m x 1.25m | IRRTENT22 | \$852.00 |
| Trade Style - 1.8m x 1.25m (Open end) | IRRTRADE18 | \$812.00 |
| Trade Style - 2.2m x 1.25m (Open end) | IRRTRADE22 | \$846.00 |

ALLOY ROOF RACKS

| | | |
|---------------------------------------|------------------|-----------|
| Cage Style - 1.4m x 1.25m | IRRCAGE14-ALLOY | \$1028.00 |
| Cage Style - 1.8m x 1.25m | IRRCAGE18-ALLOY | \$1201.00 |
| Cage Style - 2.2m x 1.25m | IRRCAGE22-ALLOY | \$1267.00 |
| Trade Style - 1.4m x 1.25m (Open end) | IRROPEN14-ALLOY | \$1015.00 |
| Trade Style - 1.8m x 1.25m (Open end) | IRRTRADE18-ALLOY | \$1183.00 |
| Trade Style - 2.2m x 1.25m (Open end) | IRRTRADE22-ALLOY | \$1235.00 |
| Flat Rack - 1.8m x 1.25m | IRRTFLAT18-ALLOY | \$1167.00 |

STEEL AND ALLOY ROOF RACK - MOUNT KITS

| | | |
|------------------------------------|------------|----------|
| Gutter Mount Feet - 210mm (8 Feet) | IRRFEET210 | \$228.00 |
|------------------------------------|------------|----------|

BREATHER KIT

| | | |
|---|----------|----------|
| Universal Twin Manifold Filtered Breather Kit | IDIFFBRE | \$115.00 |
|---|----------|----------|

Land Rover Defender

110, 130 Series
County / Dual Cab



Product Description

Part No.

Qty
Req

Retail
ea Inc GST

Please check vehicle date range (if shown) next to product description prior to ordering

SUSPENSION TO SUIT LAND ROVER DEFENDER 110, 130 SERIES

FRONT SUSPENSION

SHOCK ABSORBER

| | | | | | |
|-----------------------------|--|--|----------------|---|----------|
| Nitro Gas - Performance | | | 12080GR | 2 | \$160.00 |
| Foam Cell - Performance | | | 24080FE | 2 | \$232.00 |
| Foam Cell Pro - Performance | | | 45080FE | 2 | \$319.00 |

COIL SPRINGS

| | Est. Lift | Additional Load | | | |
|---------------------------|-----------|-----------------|-----------------|---|----------|
| Medium - V8 Petrol Engine | 45mm | 0 - 80kg | LAND007B | 1 | \$262.00 |
| Medium - 2.5 Puma Engine | 45mm | 0 - 80kg | LAND009B | 1 | \$262.00 |
| Medium - 2.2 Puma Engine | 45mm | 0 - 80kg | LAND014B | 1 | \$262.00 |

STEERING DAMPER

| | | | | | |
|-----------|--|--|-------------|---|----------|
| Foam Cell | | | 3532 | 1 | \$175.00 |
|-----------|--|--|-------------|---|----------|

OFFSET CASTER BUSH KIT

| | | | | | |
|-----------------|-------------|--|---------------|---|----------|
| Offset Bush Kit | Suits 1987+ | | 1145SK | 1 | \$160.00 |
|-----------------|-------------|--|---------------|---|----------|

• May cause driveline vibration on 1998+ models

REAR SUSPENSION

SHOCK ABSORBER

| | | | | | |
|-----------------------------|--|--|----------------|---|----------|
| Nitro Gas - Performance | | | 12640GR | 2 | \$160.00 |
| Foam Cell - Performance | | | 24640FE | 2 | \$232.00 |
| Foam Cell Pro - Performance | | | 45640FE | 2 | \$319.00 |

COIL SPRINGS

| | Est. Lift | Additional Load | | | |
|--------------------------|-----------|-----------------|-----------------|---|----------|
| Medium - (Self Leveling) | 45mm | 0 - 300kg | LAND008B | 1 | \$262.00 |
| Medium | 45mm | 0 - 300kg | LAND006B | 1 | \$276.00 |
| Heavy | 45mm | 300kg - GVM | LAND006C | 1 | \$291.00 |

• Re-Fit inner spring if equipped

SUSPENSION KIT - Specify Front Coil Springs When Ordering

| | | |
|--|-------------------|-----------|
| Medium - Nitro Gas - (Self Leveling) | LAND005BKG | \$1159.00 |
| Medium - Foam Cell - (Self Leveling) | LAND005BKF | \$1449.00 |
| Medium - Foam Cell Pro - (Self Leveling) | LAND005BKP | \$1796.00 |
| Medium - Nitro Gas | LAND006BKG | \$1174.00 |
| Medium - Foam Cell | LAND006BKF | \$1463.00 |
| Medium - Foam Cell Pro | LAND006BKP | \$1810.00 |
| Heavy - Nitro Gas | LAND006CKG | \$1188.00 |
| Heavy - Foam Cell | LAND006CKF | \$1477.00 |
| Heavy - Foam Cell Pro | LAND006CKP | \$1825.00 |

SUSPENSION KIT CONTENTS

Shock Absorbers

Coil Springs



110 Series Trayback

Land Rover Defender

Product Description

Part No.

Qty
ReqRetail
ea Inc GST

Please check vehicle date range (if shown) next to product description prior to ordering

SUSPENSION TO SUIT LAND ROVER DEFENDER 110 SERIES

FRONT SUSPENSION

SHOCK ABSORBER

| | | | | | |
|-----------------------------|--|--|----------------|---|----------|
| Nitro Gas - Performance | | | 12080GR | 2 | \$160.00 |
| Foam Cell - Performance | | | 24080FE | 2 | \$232.00 |
| Foam Cell Pro - Performance | | | 45080FE | 2 | \$319.00 |

COIL SPRINGS

| | Est. Lift | Additional Load | | | |
|---------------------------|-----------|-----------------|-----------------|---|----------|
| Medium - V8 Petrol Engine | 45mm | 0 - 80kg | LAND007B | 1 | \$262.00 |
| Medium - 2.5 Puma Engine | 45mm | 0 - 80kg | LAND009B | 1 | \$262.00 |
| Medium - 2.2 Puma Engine | 45mm | 0 - 80kg | LAND014B | 1 | \$262.00 |

STEERING DAMPER

| | | | | | |
|-----------|--|--|-------------|---|----------|
| Foam Cell | | | 3532 | 1 | \$175.00 |
|-----------|--|--|-------------|---|----------|

OFFSET CASTER BUSH KIT

| | | | | | |
|-----------------|-------------|--|---------------|---|----------|
| Offset Bush Kit | Suits 1987+ | | 1145SK | 1 | \$160.00 |
|-----------------|-------------|--|---------------|---|----------|

• May cause driveline vibration on 1998+ models

REAR SUSPENSION

SHOCK ABSORBER

| | | | | | |
|-----------------------------|--|--|----------------|---|----------|
| Nitro Gas - Performance | | | 12640GR | 2 | \$160.00 |
| Foam Cell - Performance | | | 24640FE | 2 | \$232.00 |
| Foam Cell Pro - Performance | | | 45640FE | 2 | \$319.00 |

COIL SPRINGS

| | Est. Lift | Additional Load | | | |
|--------|-----------|-----------------|-----------------|---|----------|
| Medium | 45mm | 0 - 300kg | LAND006B | 1 | \$276.00 |
| Heavy | 45mm | 300kg - GVM | LAND006C | 1 | \$291.00 |

SUSPENSION KIT - Specify Front Coil Springs When Ordering

| | | |
|------------------------|-------------------|-----------|
| Medium - Nitro Gas | LAND007BKG | \$1174.00 |
| Medium - Foam Cell | LAND007BKF | \$1463.00 |
| Medium - Foam Cell Pro | LAND007BKP | \$1810.00 |
| Heavy - Nitro Gas | LAND007CKG | \$1188.00 |
| Heavy - Foam Cell | LAND007CKF | \$1477.00 |
| Heavy - Foam Cell Pro | LAND007CKP | \$1825.00 |

SUSPENSION KIT CONTENTS

Shock Absorbers

Coil Springs

Land Rover Defender

90 Series



Product Description

Part No.

Qty
Req

Retail
ea Inc GST

Please check vehicle date range (if shown) next to product description prior to ordering

SUSPENSION TO SUIT LAND ROVER DEFENDER 90 SERIES

FRONT SUSPENSION

SHOCK ABSORBER

| | | | | | |
|-----------------------------|--|--|----------------|---|----------|
| Nitro Gas - Performance | | | 12080GR | 2 | \$160.00 |
| Foam Cell - Performance | | | 24080FE | 2 | \$232.00 |
| Foam Cell Pro - Performance | | | 45080FE | 2 | \$319.00 |

COIL SPRINGS

| | Est. Lift | Additional Load | | | |
|--------|-----------|-----------------|-----------------|---|----------|
| Medium | 45mm | 0 - 80kg | LAND009B | 1 | \$262.00 |

STEERING DAMPER

| | | | | | |
|-----------|--|--|-------------|---|----------|
| Foam Cell | | | 3532 | 1 | \$175.00 |
|-----------|--|--|-------------|---|----------|

OFFSET CASTER BUSH KIT

| | | | | | |
|-----------------|--|-------------|---------------|---|----------|
| Offset Bush Kit | | Suits 1987+ | 1145SK | 1 | \$160.00 |
|-----------------|--|-------------|---------------|---|----------|

• May cause driveline vibration on 1998+ models

REAR SUSPENSION

SHOCK ABSORBER

| | | | | | |
|-----------------------------|--|--|----------------|---|----------|
| Nitro Gas - Performance | | | 12640GR | 2 | \$160.00 |
| Foam Cell - Performance | | | 24640FE | 2 | \$232.00 |
| Foam Cell Pro - Performance | | | 45640FE | 2 | \$319.00 |

COIL SPRINGS

| | Est. Lift | Additional Load | | | |
|--------|-----------|-----------------|-----------------|---|----------|
| Medium | 45mm | 0 - 300kg | LAND011B | 1 | \$262.00 |
| Heavy | 45mm | 300kg - GVM | LAND011C | 1 | \$291.00 |

SUSPENSION KIT

| | | |
|------------------------|-------------------|-----------|
| Medium - Nitro Gas | LAND009BKG | \$1159.00 |
| Medium - Foam Cell | LAND009BKF | \$1449.00 |
| Medium - Foam Cell Pro | LAND009BKP | \$1796.00 |
| Heavy - Nitro Gas | LAND009CKG | \$1188.00 |
| Heavy - Foam Cell | LAND009CKF | \$1477.00 |
| Heavy - Foam Cell Pro | LAND009CKP | \$1825.00 |

SUSPENSION KIT CONTENTS

Shock Absorbers

Coil Springs



(Coil Springs)
1971 to 1995

Land Rover Range Rover

Product Description

Part No.

Qty
Req

Retail
ea Inc GST

Please check vehicle date range (if shown) next to product description prior to ordering

SUSPENSION TO SUIT LAND ROVER RANGE ROVER - 1971-1995

FRONT SUSPENSION

SHOCK ABSORBER

| | | | | | |
|-----------------------------|--|--|----------------|---|----------|
| Nitro Gas - Performance | | | 12080GR | 2 | \$160.00 |
| Foam Cell - Performance | | | 24080FE | 2 | \$232.00 |
| Foam Cell Pro - Performance | | | 45080FE | 2 | \$319.00 |

COIL SPRINGS

| | Est. Lift | Additional Load | | | |
|--------|-----------|-----------------|-----------------|---|----------|
| Medium | 40mm | 0 - 50kg | LAND009B | 1 | \$262.00 |
| Heavy | 40mm | 50 - 110kg | LAND007B | 1 | \$262.00 |

STEERING DAMPER

| | | | | | |
|-----------|--|--|-------------|---|----------|
| Foam Cell | | | 3511 | 1 | \$175.00 |
|-----------|--|--|-------------|---|----------|

OFFSET CASTER BUSH KIT

| | | | | | |
|-----------------|-------------|--|---------------|---|----------|
| Offset Bush Kit | Suits 1986+ | | 1145SK | 1 | \$160.00 |
|-----------------|-------------|--|---------------|---|----------|

• May cause driveline vibration in automatic transmission models

REAR SUSPENSION

SHOCK ABSORBER

| | | | | | |
|-----------------------------|--|--|----------------|---|----------|
| Nitro Gas - Performance | | | 12640GR | 2 | \$160.00 |
| Foam Cell - Performance | | | 24640FE | 2 | \$232.00 |
| Foam Cell Pro - Performance | | | 45640FE | 2 | \$319.00 |

COIL SPRINGS

| | Est. Lift | Additional Load | | | |
|--------|-----------|-----------------|-----------------|---|----------|
| Medium | 40mm | 0 - 300kg | LAND011B | 1 | \$262.00 |
| Heavy | 40mm | 300kg - GVM | LAND011C | 1 | \$291.00 |

SUSPENSION KIT - Specify Front Coil Springs When Ordering

| | | |
|------------------------|-------------------|-----------|
| Medium - Nitro Gas | LAND009BKG | \$1159.00 |
| Medium - Foam Cell | LAND009BKF | \$1449.00 |
| Medium - Foam Cell Pro | LAND009BKP | \$1796.00 |
| Heavy - Nitro Gas | LAND009CKG | \$1188.00 |
| Heavy - Foam Cell | LAND009CKF | \$1477.00 |
| Heavy - Foam Cell Pro | LAND009CKP | \$1825.00 |

SUSPENSION KIT CONTENTS

Shock Absorbers Coil Springs



Land Rover Discovery

Series 2, 3 and 4



Product Description

Part No.

Qty
Req

Retail
ea Inc GST

Please check vehicle date range (if shown) next to product description prior to ordering

ACCESSORIES TO SUIT LAND ROVER DISCOVERY SERIES 2, 3, 4

LOCKSAFE DRAWER SYSTEMS

Twin Drawers - 900mm - Fits Discovery 2 Only

ITD900

\$1298.00

Single Drawer - 900mm

ISD900

\$802.00

BREATHER KIT

Universal Twin Manifold Filtered Breather Kit

IDIFFBRE

\$115.00



Series 3 LR3 (Coil Springs)
2004 to 2009

SUSPENSION TO SUIT

Land Rover Discovery

Product Description

Part No.

Qty
Req

Retail
ea Inc GST

Please check vehicle date range (if shown) next to product description prior to ordering

SUSPENSION TO SUIT LAND ROVER DISCOVERY SERIES 3 - 2004-2009

FRONT SUSPENSION

COIL SPRINGS

| | Est. Lift | Additional Load | Part No. | Qty | Retail Price |
|--------|-----------|-----------------|----------|-----|--------------|
| Medium | 45mm | 0 - 50kg | LAND019B | 1 | \$262.00 |
| Heavy | 45mm | 50 - 100kg | LAND019C | 1 | \$242.00 |

REAR SUSPENSION

COIL SPRINGS

| | Est. Lift | Additional Load | Part No. | Qty | Retail Price |
|--------|-----------|-----------------|----------|-----|--------------|
| Medium | 45mm | 0 - 200kg | LAND020B | 1 | \$305.00 |
| Heavy | 45mm | 200kg - GVM | LAND020C | 1 | \$283.00 |

Land Rover Discovery

Series 2 (Coil Springs)
1999 to 2005



Product Description

Part No.

Qty
Req

Retail
ea Inc GST

Please check vehicle date range (if shown) next to product description prior to ordering

SUSPENSION TO SUIT LAND ROVER DISCOVERY SERIES 2 - 1999-2005

FRONT SUSPENSION

SHOCK ABSORBER

| | | | | | |
|-------------------------|--|--|----------------|---|----------|
| Nitro Gas - Performance | | | 12776GR | 2 | \$160.00 |
| Foam Cell - Performance | | | 24776FE | 2 | \$232.00 |

COIL SPRINGS

| | Est. Lift | Additional Load | | | |
|--------|-----------|-----------------|-----------------|---|----------|
| Medium | 40mm | 0 - 50kg | LAND014B | 1 | \$262.00 |
| Heavy | 40mm | 50 - 110kg | LAND009B | 1 | \$262.00 |

STEERING DAMPER

| | | | | | |
|-----------|--|--|-------------|---|----------|
| Foam Cell | | | 3502 | 1 | \$175.00 |
|-----------|--|--|-------------|---|----------|

REAR SUSPENSION

SHOCK ABSORBER

| | | | | | |
|-------------------------|--|--|----------------|---|----------|
| Nitro Gas - Performance | | | 12777GR | 2 | \$160.00 |
| Foam Cell - Performance | | | 24777FE | 2 | \$232.00 |

COIL SPRINGS

| | Est. Lift | Additional Load | | | |
|--------|-----------|-----------------|-----------------|---|----------|
| Medium | 40mm | 0 - 300kg | LAND011B | 1 | \$262.00 |
| Heavy | 40mm | 300kg - GVM | LAND011C | 1 | \$291.00 |

SUSPENSION KIT - Specify Front Coil Springs When Ordering

| | | |
|--------------------|-------------------|-----------|
| Medium - Nitro Gas | LAND014BKG | \$1159.00 |
| Medium - Foam Cell | LAND014BKF | \$1449.00 |
| Heavy - Nitro Gas | LAND014CKG | \$1188.00 |
| Heavy - Foam Cell | LAND014CKF | \$1477.00 |

SUSPENSION KIT CONTENTS

Shock Absorbers

Coil Springs



Series 1
1989 to 1998

Land Rover Discovery

Product Description

Part No.

Qty
ReqRetail
ea Inc GST

Please check vehicle date range (if shown) next to product description prior to ordering

SUSPENSION TO SUIT LAND ROVER DISCOVERY SERIES 1 - 1989-1998

FRONT SUSPENSION

SHOCK ABSORBER

| | | | | | |
|-----------------------------|--|--|----------------|---|----------|
| Nitro Gas - Performance | | | 12080GR | 2 | \$160.00 |
| Foam Cell - Performance | | | 24080FE | 2 | \$232.00 |
| Foam Cell Pro - Performance | | | 45080FE | 2 | \$319.00 |

COIL SPRINGS

| | Est. Lift | Additional Load | | | |
|--------|-----------|-----------------|-----------------|---|----------|
| Medium | 40mm | 0 - 50kg | LAND009B | 1 | \$262.00 |
| Heavy | 40mm | 50 - 110kg | LAND007B | 1 | \$262.00 |

STEERING DAMPER

| | | | | | |
|-----------|--|--|-------------|---|----------|
| Foam Cell | | | 3511 | 1 | \$175.00 |
|-----------|--|--|-------------|---|----------|

OFFSET CASTER BUSH KIT

| | | | | | |
|-----------------|--|--|---------------|---|----------|
| Offset Bush Kit | | | 1145SK | 1 | \$160.00 |
|-----------------|--|--|---------------|---|----------|

• May cause driveline vibration in automatic transmission models

REAR SUSPENSION

SHOCK ABSORBER

| | | | | | |
|-----------------------------|--|--|----------------|---|----------|
| Nitro Gas - Performance | | | 12640GR | 2 | \$160.00 |
| Foam Cell - Performance | | | 24640FE | 2 | \$232.00 |
| Foam Cell Pro - Performance | | | 45640FE | 2 | \$319.00 |

COIL SPRINGS

| | Est. Lift | Additional Load | | | |
|--------|-----------|-----------------|-----------------|---|----------|
| Medium | 40mm | 0 - 300kg | LAND011B | 1 | \$262.00 |
| Heavy | 40mm | 300kg - GVM | LAND011C | 1 | \$291.00 |

SUSPENSION KIT - Specify Front Coil Springs When Ordering

| | | |
|------------------------|-------------------|-----------|
| Medium - Nitro Gas | LAND009BKG | \$1159.00 |
| Medium - Foam Cell | LAND009BKF | \$1449.00 |
| Medium - Foam Cell Pro | LAND009BKP | \$1796.00 |
| Heavy - Nitro Gas | LAND009CKG | \$1188.00 |
| Heavy - Foam Cell | LAND009CKF | \$1477.00 |
| Heavy - Foam Cell Pro | LAND009CKP | \$1825.00 |

SUSPENSION KIT CONTENTS

Shock Absorbers

Coil Springs

LDV T60

2.8L Turbo Diesel
2017+



Product Description

Part No.

Qty
Req

Retail
ea Inc GST

Please check vehicle date range (if shown) next to product description prior to ordering

ACCESSORIES TO SUIT LDV T60 - 2017+

STEEL WINCH BULL BARS

| | | | |
|--------------------------|------------------|--|-----------|
| Commercial Deluxe | BBCD068 | | \$2345.00 |
| Proguard No Loop | BBT068-NL | | \$1973.00 |
| Proguard Single Loop Kit | BB068-SL | | \$352.00 |
| Proguard Triple Loop Kit | BB068-TL | | \$423.00 |

• Winch with Steel Cable and Roller Fairlead is not suitable - Use Winch with Synthetic Rope and Alloy Hawse only

SLIDE-AWAY ROLL UP HARD TONNEAU COVER

| | | | |
|------------------------------|--------------------------|--|-----------|
| Electric with Remote Control | ISLIDEAWAY068-E | | \$2716.00 |
| Sports Bar Adaptor | ISLIDEAWAY068-SBA | | \$135.00 |

ATLAS ROOF RACK KITS

| | | | |
|--|----------------------|--|-----------|
| Platform S with Blade Fit Kit to Suit Slideaway Hard Tonneau Cover - 1390mm Length | IFRSLDAWAYPSK | | \$1670.00 |
| Crossbar (x 2) and Fit Kit to Suit Slideaway Hard Tonneau Cover - 1500mm Width | IFRSLDAWAYC2K | | \$940.00 |

• See Page 36 and 37 for more Atlas rack and crossbar options.

BREATHER KIT

| | | | |
|---|-----------------|--|----------|
| Universal Twin Manifold Filtered Breather Kit | IDIFFBRE | | \$115.00 |
|---|-----------------|--|----------|

SUSPENSION TO SUIT LDV - 2017+

FRONT SUSPENSION

SHOCK ABSORBER

| | | | |
|-----------------------------------|----------------|---|----------|
| Nitro Gas Strut - Performance | 12745GR | 2 | \$232.00 |
| Foam Cell Strut - Performance | 24745FE | 2 | \$262.00 |
| Foam Cell Pro Strut - Performance | 45745FE | 2 | \$406.00 |

COIL SPRINGS

| | Est. Lift | Additional Load | | | |
|--------|-----------|-----------------|-----------------|---|----------|
| Medium | 40mm | 0 - 50kg | HOLD020A | 1 | \$262.00 |
| Heavy | 40mm | 50 - 110kg | HOLD020B | 1 | \$262.00 |

STRUT MOUNTS

| | | | |
|-----------------|----------------|---|---------|
| Steel Strut Top | ISST017 | 2 | \$88.00 |
|-----------------|----------------|---|---------|

TRIM PACKERS

| | | | | |
|------------------------|-----------------------|-------------------------|---|---------|
| 5mm Strut Trim Packer | Nitro Gas / Foam Cell | HILFR05/HILFR05F | 2 | \$30.00 |
| 10mm Strut Trim Packer | Nitro Gas / Foam Cell | HILFR10/HILFR10F | 2 | \$30.00 |
| 15mm Strut Trim Packer | Nitro Gas / Foam Cell | HILFR15/HILFR15F | 2 | \$30.00 |

• ONLY Compatible with Ironman 4x4 Struts (except Pro), lift height subject to 2:1 motion ratio. Unnecessary fitment may lift vehicle too high

CONTROL ARMS

| | | | |
|------------------------------|-----------------|---|----------|
| Pro-Forge Upper Control Arms | UCA041FA | 1 | \$882.00 |
|------------------------------|-----------------|---|----------|

• Does not suit models with Headlight Sensor Bracket on Upper Control Arm



2.8L Turbo Diesel
2017+

Product Description

Part No.

Qty
Req

Retail
ea Inc GST

Please check vehicle date range (if shown) next to product description prior to ordering

REAR SUSPENSION

SHOCK ABSORBER

| | | | | | |
|------------------------------|--|--|-----------------|---|----------|
| Nitro Gas - Comfort | | | 12636GRC | 2 | \$160.00 |
| Nitro Gas - Performance | | | 12636GR | 2 | \$160.00 |
| Nitro Gas - Professional | | | 12636GRP | 2 | \$160.00 |
| Foam Cell - Comfort | | | 24636FEC | 2 | \$232.00 |
| Foam Cell - Performance | | | 24636FE | 2 | \$232.00 |
| Foam Cell - Professional | | | 24636FEP | 2 | \$232.00 |
| Foam Cell Pro - Comfort | | | 45636FEC | 2 | \$319.00 |
| Foam Cell Pro - Performance | | | 45636FE | 2 | \$319.00 |
| Foam Cell Pro - Professional | | | 45636FEP | 2 | \$319.00 |

LEAF SPRINGS

| | Est. Lift | Additional Load | | | |
|-------------|-----------|-----------------|-----------------|---|----------|
| Medium | 45mm | 0 - 200kg | HOLD021A | 2 | \$421.00 |
| Heavy | 45mm | 200 - 400kg | HOLD021B | 2 | \$421.00 |
| Extra Heavy | 45mm | 400kg - 800kg | HOLD021C | 2 | \$435.00 |
| Super Heavy | 45mm | 800kg - GVM | HOLD021D | 2 | \$435.00 |

U-BOLTS

| | | | | | |
|------------|--|--|----------------|---|---------|
| U-Bolt Kit | | | 437UBKL | 2 | \$44.00 |
|------------|--|--|----------------|---|---------|

POLYURETHANE SPRING BUSHES

| | | | | | |
|----------|--|--|--------------|---|----------|
| Bush Kit | | | 770UK | 1 | \$175.00 |
|----------|--|--|--------------|---|----------|

SPACER KIT

| | | | | | |
|---------------------------------|--|--|--------------|---|---------|
| Headlight Bracket Extension Kit | | | 1207K | 1 | \$30.00 |
| Centre Bearing Spacer Kit | | | 1208K | 1 | \$30.00 |

GREASABLE SHACKLES AND PINS

| | | | | | |
|-------------------|--|--|--------------|---|---------|
| Greasable Shackle | | | 1148 | 2 | \$59.00 |
| Non-Greasable Pin | | | 387-1 | 2 | \$30.00 |

HELPER SPRINGS

| | | | | | |
|--------------------------|--|--|----------------|---|----------|
| Load Plus Helper Springs | | | LP2 | 1 | \$165.00 |
| Add-A-Leaf | | | ISL6010 | 1 | \$175.00 |

SUSPENSION KIT - Specify Front Coil Springs When Ordering

| | | | | | |
|-----------------------------|--|--|--------------------|--|-----------|
| Medium - Nitro Gas | | | HOLD021AKG2 | | \$2187.00 |
| Medium - Foam Cell | | | HOLD021AKF2 | | \$2389.00 |
| Medium - Foam Cell Pro | | | HOLD021AKP2 | | \$2852.00 |
| Heavy - Nitro Gas | | | HOLD021BKG2 | | \$2187.00 |
| Heavy - Foam Cell | | | HOLD021BKF2 | | \$2389.00 |
| Heavy - Foam Cell Pro | | | HOLD021BKP2 | | \$2852.00 |
| Extra Heavy - Nitro Gas | | | HOLD021CKG2 | | \$2216.00 |
| Extra Heavy - Foam Cell | | | HOLD021CKF2 | | \$2419.00 |
| Extra Heavy - Foam Cell Pro | | | HOLD021CKP2 | | \$2882.00 |
| Super Heavy - Nitro Gas | | | HOLD021DKG2 | | \$2216.00 |
| Super Heavy - Foam Cell | | | HOLD021DKF2 | | \$2419.00 |
| Super Heavy - Foam Cell Pro | | | HOLD021DKP2 | | \$2882.00 |

SUSPENSION KIT CONTENTS

| | | | |
|-----------------------|--------------|----------------------------|-----------------------|
| Shock Absorbers | Coil Springs | U-Bolts | Headlight Bracket Kit |
| Strut Shock Absorbers | Leaf Springs | Polyurethane Spring Bushes | |



Mahindra Scorpio

Getaway Pik-Up
2002 to 2016



Product Description

Part No.

Qty
Req

Retail
ea Inc GST

Please check vehicle date range (if shown) next to product description prior to ordering

SUSPENSION TO SUIT MAHINDRA SCORPIO GETAWAY PIK-UP - 2002-2016

FRONT SUSPENSION

SHOCK ABSORBER

| | | | | |
|-------------------------|--|----------------|---|----------|
| Nitro Gas - Performance | | 12087GR | 2 | \$160.00 |
|-------------------------|--|----------------|---|----------|

TORSION BAR

| | | | | |
|-----------------------|--|---------------|---|----------|
| Up-rated Torsion Bars | | MAH001 | 1 | \$435.00 |
|-----------------------|--|---------------|---|----------|

• Minimum 60mm downward suspension travel required after adjustment

REAR SUSPENSION

SHOCK ABSORBER

| | | | | |
|-------------------------|-------------|----------------|---|----------|
| Nitro Gas - Performance | 2002 - 2012 | 12749GR | 2 | \$160.00 |
| Nitro Gas - Performance | 2012+ | 12731GR | 2 | \$160.00 |

• Check shock absorber specifications, some models can vary

LEAF SPRINGS

| | Est. Lift | Additional Load | | |
|--------|-----------|-----------------|----------------|---|
| Medium | 40mm | 0 - 200kg | MAH002B | 2 |

U-BOLTS

| | | | | |
|------------|--|----------------|---|---------|
| U-Bolt Kit | | 1103UBK | 2 | \$44.00 |
|------------|--|----------------|---|---------|

POLYURETHANE SPRING BUSHES

| | | | | |
|----------|--|--------------|---|---------|
| Bush Kit | | 719UK | 1 | \$74.00 |
|----------|--|--------------|---|---------|

GREASABLE SHACKLES AND PINS

| | | | | |
|-------------------|------------|--------------|---|---------|
| Greasable Shackle | Left side | 353LH | 1 | \$74.00 |
| Greasable Shackle | Right side | 353RH | 1 | \$74.00 |
| Greasable Pin | | 1149 | 2 | \$44.00 |

HELPER SPRINGS

| | | | | |
|--------------------------|--|------------|---|----------|
| Load Plus Helper Springs | | LP4 | 1 | \$165.00 |
|--------------------------|--|------------|---|----------|

SUSPENSION KIT

| | | | | |
|--------------------|--|------------------|--|-----------|
| Medium - Nitro Gas | | MAH002BKG | | \$2013.00 |
|--------------------|--|------------------|--|-----------|

• Check rear shock absorber part number

SUSPENSION KIT CONTENTS

Shock Absorbers
Leaf Springs

Torsion Bars
U-Bolts

Polyurethane Spring Bushes



Wagon
2002 to 2014

Mahindra Scorpio

Product Description

Part No.

Qty
Req

Retail
ea Inc GST

Please check vehicle date range (if shown) next to product description prior to ordering

SUSPENSION TO SUIT MAHINDRA SCORPIO WAGON - 2002-2014

FRONT SUSPENSION

SHOCK ABSORBER

Nitro Gas - Performance

12087GR

2

\$160.00

TORSION BAR

Uprated Torsion Bars

MAH001

1

\$435.00

• Minimum 60mm downward suspension travel required after adjustment

REAR SUSPENSION

SHOCK ABSORBER

Nitro Gas - Performance

12749GR

2

\$160.00

• Check shock absorber specifications, some models can vary

COIL SPRINGS

Medium

Est. Lift
40mm

Additional Load
0 - 200kg

MAH003B

1

\$276.00

SUSPENSION KIT

Medium - Nitro Gas

MAH003BKG

\$1348.00

SUSPENSION KIT CONTENTS

Shock Absorbers

Coil Springs

GO PREPARED



BULL BARS | SUSPENSION | RECOVERY POINTS

for a full range of 4x4 accessories visit our website

www.ironman4x4.com



Mazda BT50

6/2020+

Product Description

Part No.

Qty
ReqRetail
ea Inc GST*Please check vehicle date range (if shown) next to product description prior to ordering***ACCESSORIES TO SUIT MAZDA BT50 - 6/2020+****STEEL WINCH BULL BARS**

| | | |
|---|-----------|-----------|
| Commercial | BBC080 | \$1754.00 |
| Commercial Deluxe | BBCD080 | \$2387.00 |
| Proguard No Loop | BBT080-NL | \$1973.00 |
| Proguard Single Loop Kit | BB080-SL | \$352.00 |
| Proguard Triple Loop Kit | BB080-TL | \$423.00 |
| Driving Light / Lightbar Patch Loom - Factory LED Headlight models only | IPL074 | \$33.00 |

STEEL SIDE STEPS AND RAILS

| | | |
|----------------------|--------|-----------|
| Side Steps | SS074 | \$1006.00 |
| Side Steps and Rails | SSR074 | \$1207.00 |

TOWING

| | | |
|------------------------------------|---------|-----------|
| Rear Protection Towbar | RTB080 | \$1388.00 |
| Towbar Wiring Loom - Plug and Play | ITBL074 | \$466.00 |

RECOVERY POINTS - IRONMAN 4X4 BULL BAR ONLY

| | | |
|------------------------|--------|----------|
| Recovery Points (Pair) | IRP080 | \$277.00 |
|------------------------|--------|----------|

SNORKEL

| | | |
|---------|-------------|----------|
| 6/2020+ | ISNORKEL080 | \$437.00 |
|---------|-------------|----------|

PREMIUM UNDERBODY PROTECTION

| | | |
|---|---------|----------|
| Engine Bay and Transmission - Electric Steering Model | UBP074S | \$745.00 |
| Engine Bay and Transmission - Non-Electric Steering Model | UBP074 | \$745.00 |

LOCKSAFE DRAWER SYSTEMS

| | | |
|------------------------|---------|-----------|
| Twin Drawers - 1300mm | ITD1300 | \$1536.00 |
| Single Drawer - 1300mm | ISD1300 | \$932.00 |
| Wing Kit - 1300mm* | ITDW074 | \$367.00 |

Designed to suit factory tubs, will not suit ute liner without modification*CANOPY - PINNACLE 2 FIBREGLASS (SIDE LIFT UP WINDOWS AND CENTRAL LOCKING REAR DOOR) - FITS 4X4 AND 4X2 DUAL CAB MODELS**

| | | |
|------------|--------------|-----------|
| Pre-Primed | ICANOPY074-P | \$3213.00 |
|------------|--------------|-----------|

** Pre-primed canopies, plus colour coding.***SLIDE-AWAY ROLL UP HARD TONNEAU COVER**

| | | |
|------------------------------|-----------------|-----------|
| Electric with Remote Control | ISLIDEAWAY080-E | \$2716.00 |
|------------------------------|-----------------|-----------|

ATLAS DUAL CAB ROOF RACK KITS

| | | |
|--|---------------|-----------|
| Platform A with Blade Fit Kit (Dual Cab Only) - 1530mm Length | IFR074PAK | \$1608.00 |
| Crossbar (x 2) and Fit Kit (Dual Cab) - 1250mm Width | IFR074C2K | \$514.00 |
| Platform K with Leg Fit Kit to Suit Pinnacle 2 Canopy - 1390mm Length | IFRP2PKK | \$1294.00 |
| Crossbar (x 2) and Fit Kit to Suit Pinnacle 2 Canopy - 1250mm Width | IFRP2C125K | \$564.00 |
| Platform S with Blade Fit Kit to Suit Slideaway Hard Tonneau Cover - 1390mm Length | IFRSLDAWAYPSK | \$1670.00 |
| Crossbar (x 2) and Fit Kit to Suit Slideaway Hard Tonneau Cover - 1500mm Width | IFRSLDAWAYC2K | \$940.00 |

*• See Page 36 and 37 for more Atlas rack and crossbar options.***FENDER FLARE KITS**

| | | |
|--|---------|----------|
| Matte Black Smooth Finish 6" (Suits Dual Cab Only) | IFF6080 | \$499.00 |
|--|---------|----------|

SEAT COVER

| | | |
|------------------------|----------|----------|
| Canvas Comfort - Front | IGSC074F | \$420.00 |
| Canvas Comfort - Rear | IGSC074R | \$420.00 |

BREATHER KIT

| | | |
|---|----------|----------|
| Universal Twin Manifold Filtered Breather Kit | IDIFFBRE | \$115.00 |
|---|----------|----------|

LISTING
CONTINUED
OVER THE
PAGE

Mazda BT50

6/2020+



Product Description

Part No.

Qty
Req

Retail
ea Inc GST

Please check vehicle date range (if shown) next to product description prior to ordering

SUSPENSION TO SUIT MAZDA BT50 - 6/2020+

FRONT SUSPENSION

SHOCK ABSORBER

| | | | | | |
|-----------------------------------|--|--|----------------|---|----------|
| Nitro Gas Strut - Performance | | | 12845GR | 2 | \$232.00 |
| Foam Cell Strut - Performance | | | 24845FE | 2 | \$262.00 |
| Foam Cell Pro Strut - Performance | | | 45845FE | 2 | \$406.00 |

COIL SPRINGS

| | Est. Lift | Additional Load | | | |
|----------|-----------|-----------------|-----------------|---|----------|
| Standard | 0mm | 0 - 50kg | HOLD020S | 1 | \$262.00 |
| Light | 30mm | 0 - 50kg | HOLD020A | 1 | \$262.00 |
| Medium | 40mm | 0 - 50kg | HOLD020B | 1 | \$262.00 |
| Heavy | 40mm | 50 - 110kg | HOLD020C | 1 | \$262.00 |

STRUT MOUNTS

| | | | | | |
|-----------------|--|--|----------------|---|---------|
| Steel Strut Top | | | ISST017 | 2 | \$88.00 |
|-----------------|--|--|----------------|---|---------|

CONTROL ARMS

| | | | | | |
|------------------------------|--|--|-----------------|---|----------|
| Pro-Forge Upper Control Arms | | | UCA074FA | 1 | \$882.00 |
|------------------------------|--|--|-----------------|---|----------|

TRIM PACKERS

| | | | | |
|------------------------|-----------------------|-------------------------|---|---------|
| 5mm Strut Trim Packer | Nitro Gas / Foam Cell | HILFR05/HILFR05F | 2 | \$30.00 |
| 10mm Strut Trim Packer | Nitro Gas / Foam Cell | HILFR10/HILFR10F | 2 | \$30.00 |
| 15mm Strut Trim Packer | Nitro Gas / Foam Cell | HILFR15/HILFR15F | 2 | \$30.00 |

• ONLY Compatible with Ironman 4x4 Struts (except Pro), lift height subject to 2:1 motion ratio. Unnecessary fitment may lift vehicle too high

REAR SUSPENSION

SHOCK ABSORBER

| | | | | | |
|------------------------------|--|--|-----------------|---|----------|
| Nitro Gas - Comfort | | | 12698GRC | 2 | \$160.00 |
| Nitro Gas - Performance | | | 12698GR | 2 | \$160.00 |
| Nitro Gas - Professional | | | 12698GRP | 2 | \$160.00 |
| Foam Cell - Comfort | | | 24698FEC | 2 | \$232.00 |
| Foam Cell - Performance | | | 24698FE | 2 | \$232.00 |
| Foam Cell - Professional | | | 24698FEP | 2 | \$232.00 |
| Foam Cell Pro - Comfort | | | 45698FEC | 2 | \$319.00 |
| Foam Cell Pro - Performance | | | 45698FE | 2 | \$319.00 |
| Foam Cell Pro - Professional | | | 45698FEP | 2 | \$319.00 |

LEAF SPRINGS

| | Est. Lift | Additional Load | | | |
|-------------|-----------|-----------------|-----------------|---|----------|
| Light | 30mm | 0 - 200kg | HOLD021A | 2 | \$421.00 |
| Medium | 45mm | 0 - 300kg | HOLD021B | 2 | \$421.00 |
| Heavy | 45mm | 300kg - 600kg | HOLD021C | 2 | \$435.00 |
| Extra Heavy | 45mm | 600kg - GVM | HOLD021D | 2 | \$435.00 |

U-BOLTS

| | | | | | |
|------------|----------------|--|----------------|---|---------|
| U-Bolt Kit | | | 437UBKL | 2 | \$44.00 |
| U-Bolt Kit | Suits HOLD021D | | 678UBK | 2 | \$44.00 |

POLYURETHANE SPRING BUSHES

| | | | | | |
|----------|--|--|--------------|---|----------|
| Bush Kit | | | 770UK | 1 | \$175.00 |
|----------|--|--|--------------|---|----------|

SPACER KIT

| | | | | | |
|---------------------------|--|--|--------------|---|---------|
| Brake Hose Relocation Kit | | | 1152K | 1 | \$15.00 |
|---------------------------|--|--|--------------|---|---------|

GREASABLE SHACKLES AND PINS

| | | | | | |
|-------------------|--|--|--------------|---|---------|
| Greasable Shackle | | | 1156 | 2 | \$59.00 |
| Non-Greasable Pin | | | 387-1 | 2 | \$30.00 |

HELPER SPRINGS

| | | | | | |
|------------|--|--|----------------|---|----------|
| Add-A-Leaf | | | ISL6010 | 1 | \$175.00 |
|------------|--|--|----------------|---|----------|





6/2020+

Mazda BT50

Product Description

Part No.

**Qty
Req**

**Retail
ea Inc GST**

Please check vehicle date range (if shown) next to product description prior to ordering

SUSPENSION KIT - Specify Front Coil Springs When Ordering

| | | |
|-----------------------------|-------------|-----------|
| Light - Nitro Gas | HOLD021AKG3 | \$2157.00 |
| Light - Foam Cell | HOLD021AKF3 | \$2360.00 |
| Light - Foam Cell Pro | HOLD021AKP3 | \$2824.00 |
| Medium - Nitro Gas | HOLD021BKG3 | \$2157.00 |
| Medium - Foam Cell | HOLD021BKF3 | \$2360.00 |
| Medium - Foam Cell Pro | HOLD021BKP3 | \$2824.00 |
| Heavy - Nitro Gas | HOLD021CKG3 | \$2187.00 |
| Heavy - Foam Cell | HOLD021CKF3 | \$2389.00 |
| Heavy - Foam Cell Pro | HOLD021CKP3 | \$2852.00 |
| Extra Heavy - Nitro Gas | HOLD021DKG3 | \$2187.00 |
| Extra Heavy - Foam Cell | HOLD021DKF3 | \$2389.00 |
| Extra Heavy - Foam Cell Pro | HOLD021DKP3 | \$2852.00 |

SUSPENSION KIT CONTENTS

| | | | |
|-----------------------|--------------|----------------------------|---------------------------|
| Shock Absorbers | Coil Springs | Polyurethane Spring Bushes | Brake Hose Relocation Kit |
| Strut Shock Absorbers | Leaf Springs | U-Bolts | |



OPTIONS AVAILABLE FOR THIS VEHICLE - SEE PAGE 383

Mazda BT50

2012 to 5/2020
Includes 5/2018 (Facelift)



Product Description

Part No.

Qty
Req

Retail
ea Inc GST

Please check vehicle date range (if shown) next to product description prior to ordering

ACCESSORIES TO SUIT MAZDA BT50 - 2012-5/2020

STEEL WINCH BULL BARS

| | | |
|--------------------------|-----------|-----------|
| Commercial | BBC039 | \$1723.00 |
| Commercial Deluxe | BBCD039 | \$2345.00 |
| Proguard No Loop | BBT039-NL | \$1939.00 |
| Proguard Single Loop Kit | BB054-SL | \$352.00 |
| Proguard Triple Loop Kit | BB039-TL | \$423.00 |

• Can also be fitted to both 2WD and 4WD models.

STEEL SIDE STEPS AND RAILS - FITS DUAL CAB MODELS ONLY

| | | |
|------------------|--------|-----------|
| Side Steps Rails | SSR039 | \$1155.00 |
|------------------|--------|-----------|

TOWING

| | | |
|---|-------------|-----------|
| Class 4 Towbar - Compatible with Factory Rear Bumper | TB066 | \$608.00 |
| Rear Protection Towbar - Full Rear Bumper Replacement | RTB066 | \$1388.00 |
| Rear Protection Towbar Plates (Pair) | RTBPLATE001 | \$153.00 |
| Towbar Wiring Loom - Plug and Play | ITBL039 | \$383.00 |

RECOVERY POINTS - IRONMAN 4X4 BULL BAR ONLY

| | | |
|--|--------|----------|
| Recovery Points - 5000kg Rating (Pair) | IRP054 | \$340.00 |
|--|--------|----------|

BATTERY TRAY - DUAL CAB ONLY

| | | |
|-------------------|-----------|----------|
| Suits 10" Battery | IBTRAY054 | \$201.00 |
|-------------------|-----------|----------|

LONG RANGE FUEL TANK

| | | |
|-------------------------------|---------|-----------|
| 140L* - Fits 3.2L Diesel only | TANK007 | \$1180.00 |
|-------------------------------|---------|-----------|

* Usable volume may differ to the stated tank capacity

PREMIUM UNDERBODY PROTECTION

| | | |
|---|--------|----------|
| Engine Bay and Transmission | UBP054 | \$782.00 |
| Engine Bay and Transmission - DPF Models (Retains factory transmission plate) | UBP055 | \$550.00 |

UNDERBODY PROTECTION

| | | |
|--|---------|----------|
| Engine Bay and Transmission - <i>While Stocks Last</i> | IUP014K | \$494.00 |
|--|---------|----------|

LOCKSAFE DRAWER SYSTEMS

| | | |
|------------------------|---------|-----------|
| Twin Drawers - 1300mm | ITD1300 | \$1536.00 |
| Single Drawer - 1300mm | ISD1300 | \$932.00 |
| Wing Kit - 1300mm* | ITDW037 | \$367.00 |

*Designed to suit factory tubs, will not suit ute liner without modification.



Mazda BT50

2012 to 5/2020
Includes 5/2018 (Facelift)

| Product Description | Part No. | Qty Req | Retail ea Inc GST |
|--|-------------------|------------|----------------------|
| PLEASE CHECK VEHICLE DATE RANGE (IF SHOWN) NEXT TO PRODUCT DESCRIPTION PRIOR TO ORDERING | | | |
| CANOPY - ABS PLASTIC (SIDE LIFT UP WINDOWS AND CENTRAL LOCKING REAR DOOR) - FITS 4X4 AND 4X2 DUAL CAB MODELS | | | |
| Pre-Primed | CANOPY010-P † | | \$3238.00 |
| Winning Blue (WVW) | CANOPY010-WB | | \$3856.00 |
| Magnetic Grey (WVQ) | CANOPY010-M † | | \$3856.00 |
| Jet Black Mica (41W) | CANOPY018-B | | \$3856.00 |
| ABS Canopy Rack Feet | IRRFEETABS14 | | \$287.00 |
| <ul style="list-style-type: none"> • Includes tub strengthening bracket (CANOPY010 BRACKET) • Colour code and build date must be confirmed for Aluminium Metallic Canopies (CANOPY010-AM) • See Page 38 for 1.4m Roof Rack options and pricing. | | | |
| † With central locking | | | |
| CANOPY - PINNACLE SMOOTH FINISH FIBREGLASS (SIDE LIFT UP WINDOWS AND CENTRAL LOCKING REAR DOOR) - FITS 4X4 AND 4X2 DUAL CAB MODELS | | | |
| Frozen White (WVZ) | CANFIBRE054-FW | | \$3763.00 |
| Magnetic Grey (WVQ) | CANFIBRE054-M | | \$3763.00 |
| Shadow Black (UO) | CANFIBRE054-SB | | \$3763.00 |
| CANOPY - PINNACLE 2 SMOOTH FINISH FIBREGLASS (SIDE LIFT UP WINDOWS AND CENTRAL LOCKING REAR DOOR) - FITS 4X4 AND 4X2 DUAL CAB MODELS | | | |
| Pre-Primed | ICANOPY054-P | | \$3213.00 |
| Aluminium Metallic (SWR) (38P) | ICANOPY054-AM | | \$3763.00 |
| Arctic White (SWU) | ICANOPY054-AW | | \$3763.00 |
| Blue Lightning (SW3) | ICANOPY054-BL | | \$3763.00 |
| Frozen White (WVZ) | ICANOPY054-FW | | \$3763.00 |
| Meteor Grey (42A) (SWT) | ICANOPY054-G | | \$3763.00 |
| Shadow Black (UO) | ICANOPY054-SB | | \$3763.00 |
| * Pre-primed canopies, plus colour coding. | | | |
| TUB STRENGTHENING BRACKET | | | |
| To suit all Canopies - (Must be fitted) | CANOPY010 BRACKET | | \$54.00 |
| SLIDE-AWAY ROLL UP HARD TONNEAU COVER | | | |
| Electric with Remote Control | ISLIDEAWAY054-E | | \$2716.00 |
| ATLAS DUAL CAB ROOF RACK KITS | | | |
| Platform A with Blade Fit Kit (Dual Cab Only) - 1530mm Length | IFR054PAK | | \$1816.00 |
| Crossbar (x 2) and Fit Kit (Dual Cab) - 1250mm Width | IFR054C2K | | \$699.00 |
| Platform K with Leg Fit Kit to Suit Pinnacle 2 Canopy - 1390mm Length | IFRP2PKK | | \$1294.00 |
| Crossbar (x 2) and Fit Kit to Suit Pinnacle 2 Canopy - 1250mm Width | IFRP2C125K | | \$564.00 |
| Platform S with Blade Fit Kit to Suit Slideaway Hard Tonneau Cover - 1390mm Length | IFRSLDAWAYPSK | | \$1670.00 |
| Crossbar (x 2) and Fit Kit to Suit Slideaway Hard Tonneau Cover - 1500mm Width | IFRSLDAWAYC2K | | \$940.00 |
| • See Page 36 and 37 for more Atlas rack and crossbar options. | | | |
| FENDER FLARE KITS | | | |
| Matte Black Smooth Finish 6" (Suits Dual Cab with Side Indicator Light Only) | IFF6039I | | \$499.00 |
| Matte Black Smooth Finish 6" (Suits Dual Cab Only) | IFF6039 | | \$499.00 |
| SEAT COVER | | | |
| 2012-2015 Canvas Comfort - Front | ICSC038F | | \$420.00 |
| 2012-2015 Canvas Comfort - Rear | ICSC038R | | \$420.00 |
| 2016+ Canvas Comfort - Front | ICSC054F | | \$420.00 |
| 2016+ Canvas Comfort - Rear | ICSC055R | | \$420.00 |
| BREATHER KIT | | | |
| Universal Twin Manifold Filtered Breather Kit | IDIFFBRE | | \$115.00 |

LISTING
CONTINUED
OVER THE
PAGE

Mazda BT50

2011 to 5/2020



Product Description

Part No.

Qty
Req

Retail
ea Inc GST

Please check vehicle date range (if shown) next to product description prior to ordering

SUSPENSION TO SUIT MAZDA BT50 - 2011-5/2020

FRONT SUSPENSION

SHOCK ABSORBER

| | | | | | |
|-----------------------------------|--|--|----------------|---|----------|
| Nitro Gas Strut - Performance | | | 12727GR | 2 | \$232.00 |
| Foam Cell Strut - Performance | | | 24727FE | 2 | \$262.00 |
| Foam Cell Pro Strut - Performance | | | 45727FE | 2 | \$406.00 |

COIL SPRINGS

| | Est. Lift | Additional Load | | | |
|----------|-----------|-----------------|----------------|---|----------|
| Standard | 0mm | 0 - 50kg | FOR001S | 1 | \$262.00 |
| Light | 35mm | 0 - 50kg | FOR001A | 1 | \$262.00 |
| Medium | 40mm | 0 - 50kg | FOR001B | 1 | \$262.00 |
| Heavy | 45mm | 50 - 110kg | FOR001C | 1 | \$262.00 |

STRUT MOUNTS

| | | | | | |
|-----------------|--|--|----------------|---|---------|
| Steel Strut Top | | | ISST014 | 2 | \$88.00 |
|-----------------|--|--|----------------|---|---------|

TRIM PACKERS

| | | | | |
|------------------------|-----------------------|-------------------------|---|---------|
| 5mm Strut Trim Packer | Nitro Gas / Foam Cell | HILFR05/HILFR05F | 2 | \$30.00 |
| 10mm Strut Trim Packer | Nitro Gas / Foam Cell | HILFR10/HILFR10F | 2 | \$30.00 |
| 15mm Strut Trim Packer | Nitro Gas / Foam Cell | HILFR15/HILFR15F | 2 | \$30.00 |

• ONLY Compatible with Ironman 4x4 Struts (except Pro), lift height subject to 2:1 motion ratio. Unnecessary fitment may lift vehicle too high

CONTROL ARMS

| | | | | | |
|------------------------------|--|--|-----------------|---|----------|
| Pro-Forge Upper Control Arms | | | UCA054FA | 1 | \$882.00 |
|------------------------------|--|--|-----------------|---|----------|

SPACER KIT

| | | | | | |
|-------------------------|--|--|--------------|---|----------|
| Sway Bar Relocation Kit | | | 1203K | 1 | \$102.00 |
|-------------------------|--|--|--------------|---|----------|

REAR SUSPENSION

SHOCK ABSORBER

| | | | | | |
|------------------------------|--|--|-----------------|---|----------|
| Nitro Gas - Comfort | | | 12095GRC | 2 | \$160.00 |
| Nitro Gas - Performance | | | 12095GR | 2 | \$160.00 |
| Foam Cell - Comfort | | | 24095FEC | 2 | \$232.00 |
| Foam Cell - Performance | | | 24095FE | 2 | \$232.00 |
| Foam Cell - Professional | | | 24095FEP | 2 | \$232.00 |
| Foam Cell Pro - Comfort | | | 45095FEC | 2 | \$319.00 |
| Foam Cell Pro - Performance | | | 45095FE | 2 | \$319.00 |
| Foam Cell Pro - Professional | | | 45095FEP | 2 | \$319.00 |

LEAF SPRINGS

| | Est. Lift | Additional Load | | | |
|--------|-----------|-----------------|----------------|---|----------|
| Light | 40mm | 0 - 200kg | FOR002A | 2 | \$392.00 |
| Medium | 45mm | 0 - 300kg | FOR002B | 2 | \$392.00 |
| Heavy | 45mm | 300kg - GVM | FOR002C | 2 | \$421.00 |

• Possible driveline vibration may occur due to increased ride height, use 1194K to reduce vibration to satisfactory level

U-BOLTS

| | | | | | |
|------------|--|--|---------------|---|---------|
| U-Bolt Kit | | | 417UBK | 2 | \$44.00 |
|------------|--|--|---------------|---|---------|

POLYURETHANE SPRING BUSHES

| | | | | | |
|----------|--|--|---------------|---|----------|
| Bush Kit | | | 1193UK | 1 | \$175.00 |
|----------|--|--|---------------|---|----------|

DRIVELINE SPACERS

| | | | | | |
|---------------------------|--|--|--------------|---|---------|
| Centre Bearing Spacer Kit | | | 1194K | 1 | \$44.00 |
|---------------------------|--|--|--------------|---|---------|

GREASABLE SHACKLES AND PINS

| | | | | | |
|-------------------|--|--|--------------|---|---------|
| Greasable Shackle | | | 1147 | 2 | \$59.00 |
| Non-Greasable Pin | | | 387-1 | 2 | \$30.00 |

HELPER SPRINGS

| | | | | | |
|--------------------------|--|--|----------------|---|----------|
| Load Plus Helper Springs | | | LP3 | 1 | \$165.00 |
| Add-A-Leaf | | | ISL6010 | 1 | \$175.00 |





2011 to 5/2020

SUSPENSION TO SUIT

Mazda BT50

Product Description

Part No.

Qty
Req

Retail
ea Inc GST

Please check vehicle date range (if shown) next to product description prior to ordering

SUSPENSION KIT - Specify Front Coil Springs When Ordering

| | | |
|------------------------|------------------|-----------|
| Light - Nitro Gas | FOR001AKG | \$2129.00 |
| Light - Foam Cell | FOR001AKF | \$2332.00 |
| Light - Foam Cell Pro | FOR001AKP | \$2795.00 |
| Medium - Nitro Gas | FOR001BKG | \$2129.00 |
| Medium - Foam Cell | FOR001BKF | \$2332.00 |
| Medium - Foam Cell Pro | FOR001BKP | \$2795.00 |
| Heavy - Nitro Gas | FOR001CKG | \$2187.00 |
| Heavy - Foam Cell | FOR001CKF | \$2389.00 |
| Heavy - Foam Cell Pro | FOR001CKP | \$2852.00 |

• Possible driveline vibration may occur due to increased ride height, use 1194K to reduce vibration to satisfactory level.

SUSPENSION KIT CONTENTS

| | | | |
|-----------------------|--------------|----------------------------|---------------------------|
| Shock Absorbers | Coil Springs | Polyurethane Spring Bushes | Centre Bearing Spacer Kit |
| Strut Shock Absorbers | Leaf Springs | U-Bolts | |

Mazda BT50

J97M
2006 to 2011



Product Description

Part No.

Qty
Req

Retail
ea Inc GST

Please check vehicle date range (if shown) next to product description prior to ordering

ACCESSORIES TO SUIT MAZDA BT50 - 2006-2011

| Product Description | Part No. | Qty Req | Retail ea Inc GST |
|---|------------|---------|-------------------|
| STEEL WINCH BULL BARS | | | |
| Commercial Deluxe Protector | BBCD024 | | \$2345.00 |
| | BBT024 | | \$2271.00 |
| • Can also be fitted to both 2WD and 4WD models. | | | |
| STEEL SIDE STEPS AND RAILS - FITS DUAL CAB MODELS ONLY | | | |
| Side Steps | SS009 | | \$1006.00 |
| Side Steps and Rails | SSR007 | | \$1207.00 |
| SNORKEL | | | |
| 3.0L TDi Diesel | ISNORKE024 | | \$437.00 |
| LONG RANGE FUEL TANK | | | |
| 122L* - Fits Dual and Single Cab only | TANK006 | | \$1180.00 |
| * Usable volume may differ to the stated tank capacity | | | |
| LOCKSAFE DRAWER SYSTEMS | | | |
| Twin Drawers - 1300mm | ITD1300 | | \$1536.00 |
| Single Drawer - 1300mm | ISD1300 | | \$932.00 |
| BREATHER KIT | | | |
| Universal Twin Manifold Filtered Breather Kit | IDIFFBRE | | \$115.00 |



Mazda BT50

2006 to 2011

Product Description

Part No.

Qty
ReqRetail
ea Inc GST*Please check vehicle date range (if shown) next to product description prior to ordering***SUSPENSION TO SUIT MAZDA BT50 - 2006-2011****FRONT SUSPENSION****SHOCK ABSORBER**

| | | | | |
|-----------------------------|--|----------------|---|----------|
| Nitro Gas - Performance | | 12667GR | 2 | \$160.00 |
| Foam Cell - Performance | | 24667FE | 2 | \$232.00 |
| Foam Cell Pro - Performance | | 45667FE | 2 | \$319.00 |

TORSION BAR

| | | | | |
|----------------------|-----------------|-----------------|---|----------|
| Uprated Torsion Bars | Duratorq Engine | MAZDA014 | 1 | \$435.00 |
| Uprated Torsion Bars | 2.5L WLT Engine | MAZDA005 | 1 | \$435.00 |

- MAZDA014 is 1024mm in length, used on most vehicles. Vehicles with 2.5L WLT Engine use MAZDA005 (924mm) Torsion Bar

- Minimum 60mm downward suspension travel required after adjustment

REAR SUSPENSION**SHOCK ABSORBER**

| | | | | |
|------------------------------|--|-----------------|---|----------|
| Nitro Gas - Comfort | | 12095GRC | 2 | \$160.00 |
| Nitro Gas - Performance | | 12095GR | 2 | \$160.00 |
| Foam Cell - Comfort | | 24095FEC | 2 | \$232.00 |
| Foam Cell - Performance | | 24095FE | 2 | \$232.00 |
| Foam Cell - Professional | | 24095FEP | 2 | \$232.00 |
| Foam Cell Pro - Comfort | | 45095FEC | 2 | \$319.00 |
| Foam Cell Pro - Performance | | 45095FE | 2 | \$319.00 |
| Foam Cell Pro - Professional | | 45095FEP | 2 | \$319.00 |

LEAF SPRINGS

| | Est. Lift | Additional Load | | | |
|-------------|-----------|-----------------|------------------|---|----------|
| Light | 40mm | 0 - 100kg | MAZDA041A | 2 | \$392.00 |
| Medium | 40mm | 0 - 200kg | MAZDA041B | 2 | \$392.00 |
| Heavy | 40mm | 200 - 400kg | MAZDA041C | 2 | \$421.00 |
| Extra Heavy | 40mm | 400kg - GVM | MAZDA041D | 2 | \$421.00 |

U-BOLTS

| | | | | |
|------------|--|---------------|---|---------|
| U-Bolt Kit | | 417UBK | 2 | \$44.00 |
|------------|--|---------------|---|---------|

POLYURETHANE SPRING BUSHES

| | | | | |
|----------|--|--------------|---|---------|
| Bush Kit | | 759UK | 1 | \$88.00 |
|----------|--|--------------|---|---------|

GREASABLE SHACKLES AND PINS

| | | | | |
|-------------------|--|--------------|---|---------|
| Greasable Shackle | | 386-1 | 2 | \$59.00 |
|-------------------|--|--------------|---|---------|

HELPER SPRINGS

| | | | | |
|--------------------------|--|----------------|---|----------|
| Load Plus Helper Springs | | LP3 | 1 | \$165.00 |
| Add-A-Leaf | | ISL6010 | 1 | \$175.00 |

SUSPENSION KIT

| | | |
|-----------------------------|--------------------|-----------|
| Light - Nitro Gas | MAZDA041AKG | \$2028.00 |
| Light - Foam Cell | MAZDA041AKF | \$2317.00 |
| Light - Foam Cell Pro | MAZDA041AKP | \$2664.00 |
| Medium - Nitro Gas | MAZDA041BKG | \$2028.00 |
| Medium - Foam Cell | MAZDA041BKF | \$2317.00 |
| Medium - Foam Cell Pro | MAZDA041BKP | \$2664.00 |
| Heavy - Nitro Gas | MAZDA041CKG | \$2085.00 |
| Heavy - Foam Cell | MAZDA041CKF | \$2375.00 |
| Heavy - Foam Cell Pro | MAZDA041CKP | \$2723.00 |
| Extra Heavy - Nitro Gas | MAZDA041DKG | \$2085.00 |
| Extra Heavy - Foam Cell | MAZDA041DKF | \$2375.00 |
| Extra Heavy - Foam Cell Pro | MAZDA041DKP | \$2723.00 |

- Check Torsion Bar length before ordering

SUSPENSION KIT CONTENTS

Shock Absorbers

Torsion Bars

Polyurethane Spring Bushes

Leaf Springs

U-Bolts



Outlasting the Outback



Mazda B Series

Bravo
1987 to 2006

Product Description

Part No.

Qty
ReqRetail
ea Inc GST

Please check vehicle date range (if shown) next to product description prior to ordering

SUSPENSION TO SUIT MAZDA B SERIES BRAVO - 1987-2006

FRONT SUSPENSION

SHOCK ABSORBER

| | | | |
|-----------------------------|----------------|---|----------|
| Nitro Gas - Performance | 12667GR | 2 | \$160.00 |
| Foam Cell - Performance | 24667FE | 2 | \$232.00 |
| Foam Cell Pro - Performance | 45667FE | 2 | \$319.00 |

TORSION BAR

| | | | |
|----------------------|-----------------|---|----------|
| Uprated Torsion Bars | MAZDA005 | 1 | \$435.00 |
|----------------------|-----------------|---|----------|

• Minimum 60mm downward suspension travel required after adjustment

REAR SUSPENSION

SHOCK ABSORBER

| | | | |
|------------------------------|-----------------|---|----------|
| Nitro Gas - Comfort | 12095GRC | 2 | \$160.00 |
| Nitro Gas - Performance | 12095GR | 2 | \$160.00 |
| Foam Cell - Comfort | 24095FEC | 2 | \$232.00 |
| Foam Cell - Performance | 24095FE | 2 | \$232.00 |
| Foam Cell - Professional | 24095FEP | 2 | \$232.00 |
| Foam Cell Pro - Comfort | 45095FEC | 2 | \$319.00 |
| Foam Cell Pro - Performance | 45095FE | 2 | \$319.00 |
| Foam Cell Pro - Professional | 45095FEP | 2 | \$319.00 |

LEAF SPRINGS

| | Est. Lift | Additional Load | | | |
|-------------|-----------|-----------------|------------------|---|----------|
| Light | 40mm | 0 - 100kg | MAZDA006A | 2 | \$392.00 |
| Medium | 40mm | 0 - 200kg | MAZDA006B | 2 | \$392.00 |
| Heavy | 40mm | 200 - 400kg | MAZDA006C | 2 | \$392.00 |
| Extra Heavy | 40mm | 400kg - GVM | MAZDA006D | 2 | \$421.00 |

U-BOLTS

| | | | |
|------------|---------------|---|---------|
| U-Bolt Kit | 415UBK | 2 | \$44.00 |
|------------|---------------|---|---------|

POLYURETHANE SPRING BUSHES

| | | | |
|----------|--------------|---|---------|
| Bush Kit | 756UK | 1 | \$88.00 |
|----------|--------------|---|---------|

GREASABLE SHACKLES AND PINS

| | | | |
|-------------------|--------------|---|---------|
| Greasable Shackle | 386-1 | 2 | \$59.00 |
| Greasable Pin | 794 | 2 | \$44.00 |

HELPER SPRINGS

| | | | |
|--------------------------|----------------|---|----------|
| Load Plus Helper Springs | LP3 | 1 | \$165.00 |
| Add-A-Leaf | ISL6010 | 1 | \$175.00 |

SUSPENSION KIT

| | | |
|-----------------------------|--------------------|-----------|
| Light - Nitro Gas | MAZDA006AKG | \$2028.00 |
| Light - Foam Cell | MAZDA006AKF | \$2317.00 |
| Light - Foam Cell Pro | MAZDA006AKP | \$2664.00 |
| Medium - Nitro Gas | MAZDA006BKG | \$2028.00 |
| Medium - Foam Cell | MAZDA006BKF | \$2317.00 |
| Medium - Foam Cell Pro | MAZDA006BKP | \$2664.00 |
| Heavy - Nitro Gas | MAZDA006CKG | \$2028.00 |
| Heavy - Foam Cell | MAZDA006CKF | \$2317.00 |
| Heavy - Foam Cell Pro | MAZDA006CKP | \$2664.00 |
| Extra Heavy - Nitro Gas | MAZDA006DKG | \$2085.00 |
| Extra Heavy - Foam Cell | MAZDA006DKF | \$2375.00 |
| Extra Heavy - Foam Cell Pro | MAZDA006DKP | \$2723.00 |

SUSPENSION KIT CONTENTS

Shock Absorbers
Leaf Springs

Torsion Bars
U-Bolts

Polyurethane Spring Bushes

Mercedes-Benz G-Wagen

W460, W461, W463
1979+



Product Description

Part No.

Qty
Req

Retail
ea Inc GST

Please check vehicle date range (if shown) next to product description prior to ordering

SUSPENSION TO SUIT MERCEDES-BENZ G-WAGEN W460, W461, W463 - 1979+

FRONT SUSPENSION

SHOCK ABSORBER

| | | | | | |
|-------------------------|--|--|----------------|---|----------|
| Nitro Gas - Performance | | | 12811GR | 2 | \$160.00 |
| Foam Cell - Performance | | | 24811FE | 2 | \$232.00 |

COIL SPRINGS

| | | | | | |
|--------|-------------------|-----------------------------|-----------------|---|----------|
| Medium | Est. Lift 45mm | Additional Load 0 - 50kg | MERC020B | 1 | \$283.00 |
|--------|-------------------|-----------------------------|-----------------|---|----------|

REAR SUSPENSION

SHOCK ABSORBER

| | | | | | |
|-------------------------|--|--|----------------|---|----------|
| Nitro Gas - Performance | | | 12812GR | 2 | \$160.00 |
| Foam Cell - Performance | | | 24812FE | 2 | \$232.00 |

COIL SPRINGS

| | | | | | |
|--------|-------------------|------------------------------|-----------------|---|----------|
| Medium | Est. Lift 45mm | Additional Load 0 - 300kg | MERC021B | 1 | \$283.00 |
|--------|-------------------|------------------------------|-----------------|---|----------|

SUSPENSION KIT

| | | | | | |
|--------------------|--|--|-------------------|--|-----------|
| Medium - Nitro Gas | | | MERC021BKG | | \$1206.00 |
| Medium - Foam Cell | | | MERC021BKF | | \$1494.00 |

SUSPENSION KIT CONTENTS

Shock Absorbers

Coil Springs



G55 AMG

Mercedes-Benz G-Wagen

Product Description

Part No.

Qty
Req

Retail
ea Inc GST

Please check vehicle date range (if shown) next to product description prior to ordering

SUSPENSION TO SUIT MERCEDES-BENZ G-WAGEN G55 AMG

FRONT SUSPENSION

SHOCK ABSORBER

Foam Cell - Performance

24788FE

2

\$232.00

COIL SPRINGS

Est. Lift

Additional Load

Medium

45mm

0 - 50kg

MERC015B

1

\$305.00

REAR SUSPENSION

SHOCK ABSORBER

Foam Cell - Performance

24789FE

2

\$232.00

COIL SPRINGS

Est. Lift

Additional Load

Medium

45mm

0 - 300kg

MERC016B

1

\$305.00

SUSPENSION KIT

Medium - Foam Cell

MERC015BKF

\$1536.00

SUSPENSION KIT CONTENTS

Shock Absorbers

Coil Springs



Mercedes-Benz Unimog

UL1700, 2450, U5000
1300, 1550, U4000



Product Description

Part No.

Qty
Req

Retail
ea Inc GST

Please check vehicle date range (if shown) next to product description prior to ordering

SUSPENSION TO SUIT MERCEDES-BENZ UNIMOG

FRONT SUSPENSION

SHOCK ABSORBER

| | | | | |
|-----------------------------|---------------------|----------------|---|----------|
| Foam Cell Pro - Performance | 10 Bolt Axle Models | 45802FE | 2 | \$319.00 |
| Foam Cell Pro - Performance | 6 Bolt Axle Models | 45803FE | 2 | \$319.00 |

REAR SUSPENSION

SHOCK ABSORBER

| | | | | |
|-----------------------------|---------------------|----------------|---|----------|
| Foam Cell Pro - Performance | 10 Bolt Axle Models | 45802FE | 2 | \$319.00 |
| Foam Cell Pro - Performance | 6 Bolt Axle Models | 45803FE | 2 | \$319.00 |



4 Cyl Models
2017 to 5/2020

Mercedes-Benz X-Class

Product Description

Part No.

Qty
Req

Retail
ea Inc GST

Please check vehicle date range (if shown) next to product description prior to ordering

SUSPENSION TO SUIT MERCEDES-BENZ X-CLASS - 2017-5/2020

FRONT SUSPENSION

SHOCK ABSORBER

| | | | | | |
|-----------------------------------|--|--|----------------|---|----------|
| Nitro Gas Strut - Performance | | | 12716GR | 2 | \$232.00 |
| Foam Cell Strut - Performance | | | 24716FE | 2 | \$262.00 |
| Foam Cell Pro Strut - Performance | | | 45716FE | 2 | \$406.00 |

• Foam Cell Pro contains a single adjusting ring for driveshaft clearance

COIL SPRINGS

| | Est. Lift | Additional Load | | | |
|-----------------|-----------|-----------------|-----------------|---|----------|
| Standard Height | 0mm | 0 - 50kg | NISS040A | 1 | \$262.00 |
| Light | 20mm | 0 - 50kg | NISS040B | 1 | \$262.00 |
| Medium | 35mm | 0 - 80kg | NISS040C | 1 | \$262.00 |
| Heavy | 40mm | 50 - 110kg | NISS040D | 1 | \$262.00 |

STRUT MOUNTS

| | | | | | |
|-----------------|--|--|----------------|---|---------|
| Steel Strut Top | | | ISST007 | 2 | \$88.00 |
|-----------------|--|--|----------------|---|---------|

TRIM PACKERS

| | | | | |
|------------------------|-----------------------|-------------------------|---|---------|
| 5mm Strut Trim Packer | Nitro Gas / Foam Cell | HILFR05/HILFR05F | 2 | \$30.00 |
| 10mm Strut Trim Packer | Nitro Gas / Foam Cell | HILFR10/HILFR10F | 2 | \$30.00 |
| 15mm Strut Trim Packer | Nitro Gas / Foam Cell | HILFR15/HILFR15F | 2 | \$30.00 |

• ONLY Compatible with Ironman 4x4 Struts (except Pro), lift height subject to 2:1 motion ratio. Unnecessary fitment may lift vehicle too high

REAR SUSPENSION

SHOCK ABSORBER

| | | | | | |
|------------------------------|--|--|-----------------|---|----------|
| Nitro Gas - Performance | | | 12728GR | 2 | \$160.00 |
| Foam Cell - Performance | | | 24728FE | 2 | \$232.00 |
| Foam Cell - Professional | | | 24728FEP | 2 | \$232.00 |
| Foam Cell Pro - Comfort | | | 45728FEC | 2 | \$319.00 |
| Foam Cell Pro - Performance | | | 45728FE | 2 | \$319.00 |
| Foam Cell Pro - Professional | | | 45728FEP | 2 | \$319.00 |

COIL SPRINGS

| | Est. Lift | Additional Load | | | |
|-------------|-----------|-----------------|-----------------|---|----------|
| Light | 20mm | 0 - 200kg | NISS058A | 1 | \$262.00 |
| Medium | 40mm | 0 - 300kg | NISS058B | 1 | \$262.00 |
| Heavy | 40mm | 300kg - 600kg | NISS058C | 1 | \$262.00 |
| Extra Heavy | 45mm | 600kg - GVM | NISS058D | 1 | \$262.00 |

COIL SPACER

| | | | | | |
|-------------------|--|--|---------------|---|---------|
| Polyurethane 20mm | | | NAVR20 | 2 | \$44.00 |
|-------------------|--|--|---------------|---|---------|

SPACER KIT

| | | | | | |
|--|--|--|--------------|---|----------|
| Sway Bar and Headlight Bracket Extension Kit | | | 1204K | 1 | \$102.00 |
|--|--|--|--------------|---|----------|

SUSPENSION KIT - Specify Front Coil Springs When Ordering

| | | |
|-----------------------------|-------------------|-----------|
| Medium - Nitro Gas | NISS058BKG | \$1405.00 |
| Medium - Foam Cell | NISS058BKF | \$1608.00 |
| Medium - Foam Cell Pro | NISS058BKP | \$2071.00 |
| Heavy - Nitro Gas | NISS058CKG | \$1405.00 |
| Heavy - Foam Cell | NISS058CKF | \$1608.00 |
| Heavy - Foam Cell Pro | NISS058CKP | \$2071.00 |
| Extra Heavy - Nitro Gas | NISS058DKG | \$1405.00 |
| Extra Heavy - Foam Cell | NISS058DKF | \$1608.00 |
| Extra Heavy - Foam Cell Pro | NISS058DKP | \$2071.00 |

SUSPENSION KIT CONTENTS

| | |
|-----------------------|------------------------------------|
| Shock Absorbers | Coil Springs |
| Strut Shock Absorbers | Sway Bar and Headlight Bracket Kit |

Mitsubishi Pajero Sport

7/2019+



Product Description

DATE AVAILABLE

Part No.

Qty
Req

Retail
ea Inc GST

Please check vehicle date range (if shown) next to product description prior to ordering

ACCESSORIES TO SUIT MITSUBISHI PAJERO SPORT - 7/2019+

STEEL WINCH BULL BARS

Commercial Deluxe

BBCD079

\$2387.00

Proguard No Loop

Q4 2022

BBT079-NL

\$1973.00

• Winch with Steel Cable and Roller Fairlead is not suitable - Use Winch with Synthetic Rope and Alloy Hawse only

STEEL SIDE STEPS AND RAILS

Side Steps

Q1 2023

SS079

\$1003.00

RECOVERY POINTS - IRONMAN 4X4 BULL BAR ONLY

Recovery Points - 5000kg Rating (Pair)

IRP059

\$340.00

PREMIUM UNDERBODY PROTECTION

Engine Bay and Transmission

UBP050

\$782.00

SEAT COVER

Front

ICSC059F

\$420.00

Rear

ICSC059R

\$420.00

BREATHER KIT

Universal Twin Manifold Filtered Breather Kit

IDIFFBRE

\$115.00





7/2019+

Mitsubishi Pajero Sport

Product Description

Part No.

Qty
Req

Retail
ea Inc GST

Please check vehicle date range (if shown) next to product description prior to ordering

SUSPENSION TO SUIT MITSUBISHI PAJERO SPORT - 7/2019+

FRONT SUSPENSION

SHOCK ABSORBER

| | | | | | |
|---|--|--|----------------|---|----------|
| Nitro Gas Strut - Performance | | | 12715GR | 2 | \$232.00 |
| Foam Cell Strut - Performance | | | 24715FE | 2 | \$262.00 |
| Foam Cell Pro Strut - Performance* (SEE NOTE) | | | 45715FE | 2 | \$406.00 |

*NOTE: MANDATORY FITMENT of UCA050FA and MITS045B /C Coil Springs with 45715FE

COIL SPRINGS

| | Est. Lift | Additional Load | | | |
|--------------------|-----------|-----------------|-------------------|---|----------|
| Medium | 15mm | 0 - 50kg | MITSO40B | 1 | \$262.00 |
| Medium* (SEE NOTE) | 50mm | 0 - 50kg | MITSO45B * | 1 | \$262.00 |
| Heavy | 30mm | 50 - 110kg | MITSO40C | 1 | \$262.00 |
| Heavy* (SEE NOTE) | 50mm | 50 - 110kg | MITSO45C * | 1 | \$262.00 |

*NOTE: MANDATORY FITMENT of UCA050FA and 45715FE with (MITSO45B /C) Coil Springs

STRUT MOUNTS

| | | | | | |
|-----------------|--|--|----------------|---|----------|
| Steel Strut Top | | | ISST010 | 2 | \$102.00 |
|-----------------|--|--|----------------|---|----------|

TRIM PACKERS

| | | | | |
|------------------------|-----------------------|-------------------------|---|---------|
| 5mm Strut Trim Packer | Nitro Gas / Foam Cell | HILFR05/HILFR05F | 2 | \$30.00 |
| 10mm Strut Trim Packer | Nitro Gas / Foam Cell | HILFR10/HILFR10F | 2 | \$30.00 |
| 15mm Strut Trim Packer | Nitro Gas / Foam Cell | HILFR15/HILFR15F | 2 | \$30.00 |

• ONLY Compatible with Ironman 4x4 Struts, lift height subject to 2:1 motion ratio. Unnecessary fitment may lift vehicle too high

CONTROL ARMS

| | | | | | |
|------------------------------|--|--|-----------------|---|----------|
| Pro-Forge Upper Control Arms | | | UCA050FA | 1 | \$882.00 |
|------------------------------|--|--|-----------------|---|----------|

REAR SUSPENSION

SHOCK ABSORBER

| | | | | | |
|-------------------------|--|--|-----------------|---|----------|
| Nitro Gas - Performance | | | 12645GRS | 2 | \$160.00 |
| Foam Cell - Performance | | | 24645FES | 2 | \$232.00 |

COIL SPRINGS

| | Est. Lift | Additional Load | | | |
|---------------------------|-----------|-----------------|-----------------|---|----------|
| Light | 15mm | 0 - 200kg | MITSO42A | 1 | \$262.00 |
| Medium | 30mm | 0 - 250kg | MITSO42B | 1 | \$262.00 |
| Medium - with Accessories | 40mm | 250-500kg | MITSO20B | 1 | \$262.00 |
| Heavy | 40mm | 300kg - GVM | MITSO42C | 1 | \$262.00 |

• Check LHS rear coil captivity when lowering to ground

SUSPENSION KIT - Specify Front Coil Springs When Ordering

| | | |
|--------------------|--------------------|-----------|
| Medium - Nitro Gas | MITSO42BKG1 | \$1304.00 |
| Medium - Foam Cell | MITSO42BKF1 | \$1506.00 |
| Heavy - Nitro Gas | MITSO42CKG1 | \$1304.00 |
| Heavy - Foam Cell | MITSO42CKF1 | \$1506.00 |

• Please note limited lift height, due to restrictions in vehicle design.

SUSPENSION KIT CONTENTS

Shock Absorbers

Strut Shock Absorbers

Coil Springs



Mitsubishi Pajero Sport

11/2016 to 6/2019



Product Description

Part No.

Qty
Req

Retail
ea Inc GST

Please check vehicle date range (if shown) next to product description prior to ordering

ACCESSORIES TO SUIT MITSUBISHI PAJERO SPORT - 11/2016-6/2019

STEEL WINCH BULL BARS

Commercial Deluxe* - Suits GLX and GLS

BBCD059

\$2387.00

Exceed Kit - Required for Exceed model

BB059-EXCEEDKIT

\$142.00

Proguard No Loop

BBT059-NL

\$1973.00

Proguard Single Loop Kit

BB059-SL

\$352.00

Proguard Triple Loop Kit

BB059-TL

\$423.00

Driving Light / Lightbar Patch Loom

IPL059

\$38.00

** Winch with Steel Cable and Roller Fairlead is not suitable - Use Winch with Synthetic Rope and Alloy Hawse only*

** Do not fit winch control box in front of Mitsubishi Badge for vehicles with Radar.*

STEEL SIDE STEPS AND RAILS - BODY MOUNT ONLY DUE TO ELECTRIC HANDBRAKE

Side Steps

SS059

\$851.00

RECOVERY POINTS - IRONMAN 4X4 BULL BAR ONLY

Recovery Points - 5000kg Rating (Pair)

IRP059

\$340.00

SEAT COVER

Canvas Comfort - Front

ICSC059F

\$420.00

Canvas Comfort - Rear

ICSC059R

\$420.00

BREATHER KIT

Universal Twin Manifold Filtered Breather Kit

IDIFFBRE

\$115.00





2.4L Mivec
2015 to 6/2019

Mitsubishi Pajero Sport

Product Description

Part No.

Qty
ReqRetail
ea Inc GST

Please check vehicle date range (if shown) next to product description prior to ordering

SUSPENSION TO SUIT MITSUBISHI PAJERO SPORT - 2015-6/2019

FRONT SUSPENSION

SHOCK ABSORBER

| | | | | | |
|---|--|--|----------------|---|----------|
| Nitro Gas Strut - Performance | | | 12715GR | 2 | \$232.00 |
| Foam Cell Strut - Performance | | | 24715FE | 2 | \$262.00 |
| Foam Cell Pro Strut - Performance* (SEE NOTE) | | | 45715FE | 2 | \$406.00 |

*NOTE: MANDATORY FITMENT of UCA050FA and MITS045B /C Coil Springs with 45715FE

COIL SPRINGS

| | Est. Lift | Additional Load | | | |
|--------------------|-----------|-----------------|-------------------|---|----------|
| Medium | 15mm | 0 - 50kg | MITSO40B | 1 | \$262.00 |
| Medium* (SEE NOTE) | 50mm | 0 - 50kg | MITSO45B * | 1 | \$262.00 |
| Heavy | 30mm | 50 - 110kg | MITSO40C | 1 | \$262.00 |
| Heavy* (SEE NOTE) | 50mm | 50 - 110kg | MITSO45C * | 1 | \$262.00 |

*NOTE: MANDATORY FITMENT of UCA050FA and 45715FE with (MITSO45B /C) Coil Springs

STRUT MOUNTS

| | | | | | |
|-----------------|--|--|----------------|---|----------|
| Steel Strut Top | | | ISST010 | 2 | \$102.00 |
|-----------------|--|--|----------------|---|----------|

TRIM PACKERS

| | | | | |
|------------------------|-----------------------|-------------------------|---|---------|
| 5mm Strut Trim Packer | Nitro Gas / Foam Cell | HILFR05/HILFR05F | 2 | \$30.00 |
| 10mm Strut Trim Packer | Nitro Gas / Foam Cell | HILFR10/HILFR10F | 2 | \$30.00 |
| 15mm Strut Trim Packer | Nitro Gas / Foam Cell | HILFR15/HILFR15F | 2 | \$30.00 |

• ONLY Compatible with Ironman 4x4 Struts, lift height subject to 2:1 motion ratio. Unnecessary fitment may lift vehicle too high

CONTROL ARMS

| | | | | |
|------------------------------|--|-----------------|---|----------|
| Pro-Forge Upper Control Arms | | UCA050FA | 1 | \$882.00 |
|------------------------------|--|-----------------|---|----------|

REAR SUSPENSION

SHOCK ABSORBER

| | | | | |
|-------------------------|--|-----------------|---|----------|
| Nitro Gas - Performance | | 12645GRS | 2 | \$160.00 |
| Foam Cell - Performance | | 24645FES | 2 | \$232.00 |

COIL SPRINGS

| | Est. Lift | Additional Load | | | |
|---------------------------|-----------|-----------------|-----------------|---|----------|
| Light | 15mm | 0 - 200kg | MITSO42A | 1 | \$262.00 |
| Medium | 30mm | 0 - 250kg | MITSO42B | 1 | \$262.00 |
| Medium - with Accessories | 40mm | 250-500kg | MITSO20B | 1 | \$262.00 |
| Heavy | 40mm | 300kg - GVM | MITSO42C | 1 | \$262.00 |

• Check LHS rear coil captivity when lowering to ground

SUSPENSION KIT - Specify Front Coil Springs When Ordering

| | | |
|--------------------|--------------------|-----------|
| Medium - Nitro Gas | MITSO42BKG1 | \$1304.00 |
| Medium - Foam Cell | MITSO42BKF1 | \$1506.00 |
| Heavy - Nitro Gas | MITSO42CKG1 | \$1304.00 |
| Heavy - Foam Cell | MITSO42CKF1 | \$1506.00 |

• Please note limited lift height, due to restrictions in vehicle design.

SUSPENSION KIT CONTENTS

Shock Absorbers

Strut Shock Absorbers

Coil Springs

Mitsubishi Pajero

NW 2011 to NX



Product Description

Part No.

Qty
Req

Retail
ea Inc GST

Please check vehicle date range (if shown) next to product description prior to ordering

ACCESSORIES TO SUIT MITSUBISHI PAJERO - 2011-NX

STEEL WINCH BULL BARS - NOT SUITABLE FOR VEHICLES WITH FACTORY FITTED HEADLIGHT WASHERS (DRL'S NOT COMPATIBLE)

Commercial Deluxe

BBCD045

\$2345.00

BREATHER KIT

Universal Twin Manifold Filtered Breather Kit

IDIFFBRE

\$115.00



NM, NP, NS, NT
5/2000 to 2011

Mitsubishi Pajero

Product Description

Part No.

Qty
Req

Retail
ea Inc GST

Please check vehicle date range (if shown) next to product description prior to ordering

ACCESSORIES TO SUIT MITSUBISHI PAJERO - 5/2000-2011

STEEL WINCH BULL BARS - NOT SUITABLE FOR VEHICLES WITH FACTORY FITTED HEADLIGHT WASHERS (DRL'S NOT COMPATIBLE)

Commercial Deluxe - *Fits NS and NT models only*

BBCD045

\$2345.00

BREATHER KIT

Universal Twin Manifold Filtered Breather Kit

IDIFFBRE

\$115.00



Mitsubishi Pajero

Montero NM-NX
2000+



Product Description

Part No.

Qty
Req

Retail
ea Inc GST

Please check vehicle date range (if shown) next to product description prior to ordering

SUSPENSION TO SUIT MITSUBISHI PAJERO - 2000+

FRONT SUSPENSION

SHOCK ABSORBER

| | | | | | |
|-------------------------------|--|--|----------------|---|----------|
| Nitro Gas Strut - Performance | | | 12713GR | 2 | \$232.00 |
| Foam Cell Strut - Performance | | | 24713FE | 2 | \$262.00 |

COIL SPRINGS

| | Est. Lift | Additional Load | | | |
|----------------|-----------|-----------------|-----------------|---|----------|
| Medium | 40mm | 0 - 50kg | MITS038B | 1 | \$262.00 |
| Heavy - Diesel | 40mm | 50 - 100kg | MITS038C | 1 | \$262.00 |

REAR SUSPENSION

SHOCK ABSORBER

| | | | | | |
|-------------------------|--|--|----------------|---|----------|
| Nitro Gas - Performance | | | 12714GR | 2 | \$160.00 |
|-------------------------|--|--|----------------|---|----------|

COIL SPRINGS

| | Est. Lift | Additional Load | | | |
|--------------|-----------|-----------------|-----------------|---|----------|
| Medium - SWB | 40mm | 0 - 200kg | MITS039A | 1 | \$262.00 |
| Medium - LWB | 40mm | 0 - 200kg | MITS039B | 1 | \$262.00 |
| Heavy | 40mm | 200kg - GVM | MITS039C | 1 | \$262.00 |

SUSPENSION KIT - Specify Front Coil Springs When Ordering

| | | | | | |
|--------------------|-----|--------|--------------------|--|-----------|
| Medium - Nitro Gas | SWB | | MITS038AKG | | \$1304.00 |
| Medium - Nitro Gas | LWB | Petrol | MITS038BKG | | \$1304.00 |
| Medium - Nitro Gas | LWB | Diesel | MITS038CKG | | \$1304.00 |
| Heavy - Nitro Gas | LWB | Petrol | MITS038CKG1 | | \$1304.00 |
| Heavy - Nitro Gas | LWB | Diesel | MITS038CKG2 | | \$1304.00 |

- Vehicles with monocoque body construction can be subject to increased NVH (Noise) with upgraded suspension installed
- Vehicles with independent suspension must maintain a minimum of 60mm downward suspension travel
- Mandatory 4 wheel alignment after installing new suspension

SUSPENSION KIT CONTENTS

Shock Absorbers

Strut Shock Absorbers

Coil Springs



iO Pinin
1999+

Mitsubishi Pajero

Product Description

Part No.

Qty
Req

Retail
ea Inc GST

Please check vehicle date range (if shown) next to product description prior to ordering

SUSPENSION TO SUIT MITSUBISHI PAJERO - 1999+

FRONT SUSPENSION

COIL SPRINGS

| | Est. Lift | Additional Load | Part No. | Qty Req | Retail Price |
|--------|-----------|-----------------|-----------------|---------|--------------|
| Medium | 35mm | 0 - 50kg | MITSO34B | 1 | \$262.00 |

CAMBER CORRECTION

| | | | | | |
|-----------------|--|--|------------------|---|---------|
| Camber Bolt Kit | | | ICAMBER14 | 1 | \$30.00 |
|-----------------|--|--|------------------|---|---------|

REAR SUSPENSION

COIL SPRINGS

| | Est. Lift | Additional Load | Part No. | Qty Req | Retail Price |
|--------|-----------|-----------------|-----------------|---------|--------------|
| Medium | 35mm | 0 - 200kg | MITSO35B | 1 | \$262.00 |



Mitsubishi Pajero

Montero NH-NL (Coil)
6/1991 to 2000



Product Description

Part No.

Qty
Req

Retail
ea Inc GST

Please check vehicle date range (if shown) next to product description prior to ordering

SUSPENSION TO SUIT MITSUBISHI PAJERO - 6/1991-2000

FRONT SUSPENSION

SHOCK ABSORBER

| | | | | |
|-------------------------|--|----------------|---|----------|
| Nitro Gas - Performance | | 12087GR | 2 | \$160.00 |
| Foam Cell - Performance | | 24087FE | 2 | \$232.00 |

TORSION BAR

| | | | | |
|----------------------|---------------|----------------|---|----------|
| Uprated Torsion Bars | 1278mm Length | MITS013 | 1 | \$435.00 |
| Uprated Torsion Bars | 1308mm Length | MITS019 | 1 | \$435.00 |

- Check Torsion Bar length before ordering
- Minimum 60mm downward suspension travel required after adjustment

STEERING DAMPER

| | | | | |
|-----------|-----------------------------------|-------------|---|----------|
| Foam Cell | Suits vehicles w/o power steering | 3517 | 1 | \$175.00 |
|-----------|-----------------------------------|-------------|---|----------|

REAR SUSPENSION

SHOCK ABSORBER

| | | | | |
|-------------------------|--|----------------|---|----------|
| Nitro Gas - Performance | | 12646GR | 2 | \$160.00 |
| Foam Cell - Performance | | 24646FE | 2 | \$232.00 |

COIL SPRINGS

| | Est. Lift | Additional Load | | | |
|--------------|-----------|-----------------|-----------------|---|----------|
| Medium - SWB | 40mm | 0 - 200kg | MITS022B | 1 | \$262.00 |
| Medium - LWB | 40mm | 0 - 200kg | MITS020B | 1 | \$262.00 |
| Heavy | 40mm | 200kg - GVM | MITS020C | 1 | \$262.00 |

SUSPENSION KIT

| | | | |
|--------------------|-----|--------------------|-----------|
| Medium - Nitro Gas | SWB | MITS022BKG2 | \$1333.00 |
| Medium - Nitro Gas | LWB | MITS020BKG2 | \$1333.00 |
| Medium - Foam Cell | SWB | MITS022BKF2 | \$1622.00 |
| Medium - Foam Cell | LWB | MITS020BKF2 | \$1622.00 |
| Heavy - Nitro Gas | | MITS020CKG2 | \$1333.00 |
| Heavy - Foam Cell | | MITS020CKF2 | \$1622.00 |

- Check Torsion Bar length before ordering

SUSPENSION KIT CONTENTS

Shock Absorbers

Coil Springs

Torsion Bars



Montero NH-NL (Leaf)
1991 to 1999

Mitsubishi Pajero

Product Description

Part No.

Qty Req

Retail ea Inc GST

Please check vehicle date range (if shown) next to product description prior to ordering

SUSPENSION TO SUIT MITSUBISHI PAJERO - 1991-1999

FRONT SUSPENSION

SHOCK ABSORBER

| | | | | |
|-------------------------|--|----------------|---|----------|
| Nitro Gas - Performance | | 12087GR | 2 | \$160.00 |
| Foam Cell - Performance | | 24087FE | 2 | \$232.00 |

TORSION BAR

| | | | | |
|----------------------|---------------|----------------|---|----------|
| Uprated Torsion Bars | 1278mm Length | MITSO13 | 1 | \$435.00 |
| Uprated Torsion Bars | 1308mm Length | MITSO19 | 1 | \$435.00 |

- Check Torsion Bar length before ordering
- Minimum 60mm downward suspension travel required after adjustment

STEERING DAMPER

| | | | | |
|-----------|-----------------------------------|-------------|---|----------|
| Foam Cell | Suits vehicles w/o power steering | 3517 | 1 | \$175.00 |
|-----------|-----------------------------------|-------------|---|----------|

REAR SUSPENSION

SHOCK ABSORBER

| | | | | |
|--------------------------|--|-----------------|---|----------|
| Nitro Gas - Comfort | | 12636GRC | 2 | \$160.00 |
| Nitro Gas - Performance | | 12636GR | 2 | \$160.00 |
| Nitro Gas - Professional | | 12636GRP | 2 | \$160.00 |
| Foam Cell - Comfort | | 24636FEC | 2 | \$232.00 |
| Foam Cell - Performance | | 24636FE | 2 | \$232.00 |
| Foam Cell - Professional | | 24636FEP | 2 | \$232.00 |

LEAF SPRINGS

| | Est. Lift | Additional Load | | | |
|--------|-----------|-----------------|-----------------|---|----------|
| Medium | 40mm | 0 - 300kg | MITSO18B | 2 | \$392.00 |
| Heavy | 40mm | 300kg - GVM | MITSO18C | 2 | \$421.00 |

- Must use Ironman 4x4 bushes

U-BOLTS

| | | | | |
|------------|--|---------------|---|---------|
| U-Bolt Kit | | 451UBK | 2 | \$44.00 |
|------------|--|---------------|---|---------|

POLYURETHANE SPRING BUSHES

| | | | | |
|----------|--|---------------|---|---------|
| Bush Kit | | 715TUK | 1 | \$88.00 |
|----------|--|---------------|---|---------|

GREASABLE SHACKLES AND PINS

| | | | | |
|-------------------|--|------------|---|---------|
| Greasable Shackle | | 795 | 2 | \$59.00 |
| Greasable Pin | | 796 | 2 | \$30.00 |

HELPER SPRINGS

| | | | | |
|--------------------------|--|------------|---|----------|
| Load Plus Helper Springs | | LP4 | 1 | \$165.00 |
|--------------------------|--|------------|---|----------|

SUSPENSION KIT

| | | |
|--------------------|--------------------|-----------|
| Medium - Nitro Gas | MITSO18BKG2 | \$2028.00 |
| Medium - Foam Cell | MITSO18BKF2 | \$2317.00 |
| Heavy - Nitro Gas | MITSO18CKG2 | \$2085.00 |
| Heavy - Foam Cell | MITSO18CKF2 | \$2375.00 |

- Check Torsion Bar length before ordering

SUSPENSION KIT CONTENTS

Shock Absorbers
Leaf Springs

Torsion Bars
U-Bolts

Polyurethane Spring Bushes

Mitsubishi Pajero

Montero NA-NG (Coil)
1988 to 1991



Product Description

Part No.

Qty
Req

Retail
ea Inc GST

Please check vehicle date range (if shown) next to product description prior to ordering

SUSPENSION TO SUIT MITSUBISHI PAJERO - 1988-1991

FRONT SUSPENSION

SHOCK ABSORBER

| | | | | |
|-------------------------|--|----------------|---|----------|
| Nitro Gas - Performance | | 12082GR | 2 | \$160.00 |
| Foam Cell - Performance | | 24082FE | 2 | \$232.00 |

TORSION BAR

| | | | | |
|----------------------|---------------|----------------|---|----------|
| Uprated Torsion Bars | 1278mm Length | MITSO13 | 1 | \$435.00 |
| Uprated Torsion Bars | 1308mm Length | MITSO19 | 1 | \$435.00 |

- Check Torsion Bar length before ordering
- Minimum 60mm downward suspension travel required after adjustment

STEERING DAMPER

| | | | | |
|-----------|-----------------------------------|-------------|---|----------|
| Foam Cell | Suits vehicles w/o power steering | 3517 | 1 | \$175.00 |
|-----------|-----------------------------------|-------------|---|----------|

REAR SUSPENSION

SHOCK ABSORBER

| | | | | |
|-------------------------|--|-----------------|---|----------|
| Nitro Gas - Comfort | | 12645GRC | 2 | \$160.00 |
| Nitro Gas - Performance | | 12645GR | 2 | \$160.00 |
| Foam Cell - Comfort | | 24645FEC | 2 | \$232.00 |
| Foam Cell - Performance | | 24645FE | 2 | \$232.00 |

COIL SPRINGS

| | Est. Lift | Additional Load | | | |
|--------------|-----------|-----------------|-----------------|---|----------|
| Medium - SWB | 40mm | 0 - 200kg | MITSO22B | 1 | \$262.00 |
| Medium - LWB | 40mm | 0 - 200kg | MITSO20B | 1 | \$262.00 |
| Heavy | 40mm | 200kg - GVM | MITSO20C | 1 | \$262.00 |

SUSPENSION KIT

| | | | |
|--------------------|-----|--------------------|-----------|
| Medium - Nitro Gas | SWB | MITSO22BKG1 | \$1333.00 |
| Medium - Nitro Gas | LWB | MITSO20BKG1 | \$1333.00 |
| Medium - Foam Cell | SWB | MITSO22BKF1 | \$1466.00 |
| Medium - Foam Cell | LWB | MITSO20BKF1 | \$1622.00 |
| Heavy - Nitro Gas | | MITSO20CKG1 | \$1333.00 |
| Heavy - Foam Cell | | MITSO20CKF1 | \$1622.00 |

- Check Torsion Bar length before ordering

SUSPENSION KIT CONTENTS

Shock Absorbers Coil Springs



Montero NA-NG (Leaf)
Pre 1991

Mitsubishi Pajero

Product Description

Part No.

Qty
Req

Retail
ea Inc GST

Please check vehicle date range (if shown) next to product description prior to ordering

SUSPENSION TO SUIT MITSUBISHI PAJERO - PRE 1991

FRONT SUSPENSION

SHOCK ABSORBER

| | | | | |
|-------------------------|--|----------------|---|----------|
| Nitro Gas - Performance | | 12082GR | 2 | \$160.00 |
| Foam Cell - Performance | | 24082FE | 2 | \$232.00 |

TORSION BAR

| | | | | |
|----------------------|---------------|----------------|---|----------|
| Uprated Torsion Bars | 1278mm Length | MITS013 | 1 | \$435.00 |
| Uprated Torsion Bars | 1308mm Length | MITS019 | 1 | \$435.00 |

- Check Torsion Bar length before ordering
- Minimum 60mm downward suspension travel required after adjustment

STEERING DAMPER

| | | | | |
|-----------|-----------------------------------|-------------|---|----------|
| Foam Cell | Suits vehicles w/o power steering | 3517 | 1 | \$175.00 |
|-----------|-----------------------------------|-------------|---|----------|

REAR SUSPENSION

SHOCK ABSORBER

| | | | | |
|--------------------------|--|-----------------|---|----------|
| Nitro Gas - Comfort | | 12636GRC | 2 | \$160.00 |
| Nitro Gas - Performance | | 12636GR | 2 | \$160.00 |
| Nitro Gas - Professional | | 12636GRP | 2 | \$160.00 |
| Foam Cell - Comfort | | 24636FEC | 2 | \$232.00 |
| Foam Cell - Performance | | 24636FE | 2 | \$232.00 |
| Foam Cell - Professional | | 24636FEP | 2 | \$232.00 |

LEAF SPRINGS

| | Est. Lift | Additional Load | | | |
|--------|-----------|-----------------|-----------------|---|----------|
| Medium | 45mm | 0 - 300kg | MITS018B | 2 | \$392.00 |
| Heavy | 45mm | 300kg - GVM | MITS018C | 2 | \$421.00 |

- Must use Ironman 4x4 bushes

U-BOLTS

| | | | | |
|------------|--|---------------|---|---------|
| U-Bolt Kit | | 451UBK | 2 | \$44.00 |
|------------|--|---------------|---|---------|

POLYURETHANE SPRING BUSHES

| | | | | |
|----------|--|--------------|---|---------|
| Bush Kit | | 715UK | 1 | \$88.00 |
|----------|--|--------------|---|---------|

GREASABLE SHACKLES AND PINS

| | | | | |
|-------------------|--|------------|---|---------|
| Greasable Shackle | | 795 | 2 | \$59.00 |
| Greasable Pin | | 796 | 2 | \$30.00 |

HELPER SPRINGS

| | | | | |
|--------------------------|--|------------|---|----------|
| Load Plus Helper Springs | | LP4 | 1 | \$165.00 |
|--------------------------|--|------------|---|----------|

SUSPENSION KIT

| | | |
|--------------------|--------------------|-----------|
| Medium - Nitro Gas | MITS018BKG1 | \$2028.00 |
| Medium - Foam Cell | MITS018BKF1 | \$2317.00 |
| Heavy - Nitro Gas | MITS018CKG1 | \$2085.00 |
| Heavy - Foam Cell | MITS018CKF1 | \$2375.00 |

- Check Torsion Bar length before ordering

SUSPENSION KIT CONTENTS

| | | |
|-----------------|--------------|----------------------------|
| Shock Absorbers | Torsion Bars | Polyurethane Spring Bushes |
| Leaf Springs | U-Bolts | |



Mitsubishi Pajero

Pajero Sport /
Montero Sport / Dakar PB
2009 to 2015



Product Description

Part No.

Qty
Req

Retail
ea Inc GST

Please check vehicle date range (if shown) next to product description prior to ordering

SUSPENSION TO SUIT MITSUBISHI PAJERO - 2009-2015

FRONT SUSPENSION

SHOCK ABSORBER

| | | | | | |
|-------------------------------|--|--|----------------|---|----------|
| Nitro Gas Strut - Performance | | | 12715GR | 2 | \$232.00 |
| Foam Cell Strut - Performance | | | 24715FE | 2 | \$262.00 |

COIL SPRINGS

| | Est. Lift | Additional Load | | | |
|-----------------|-----------|-----------------|-----------------|---|----------|
| Standard Height | 0mm | 0 - 50kg | MITS040S | 1 | \$262.00 |
| Light | 35mm | 0 - 50kg | MITS040A | 1 | \$262.00 |
| Medium | 40mm | 0 - 80kg | MITS040B | 1 | \$262.00 |
| Heavy | 40mm | 80 - 110kg | MITS040C | 1 | \$262.00 |

STRUT MOUNTS

| | | | | | |
|-----------------|--|--|----------------|---|----------|
| Steel Strut Top | | | ISST010 | 2 | \$102.00 |
|-----------------|--|--|----------------|---|----------|

TRIM PACKERS

| | | | | |
|------------------------|-----------------------|-------------------------|---|---------|
| 5mm Strut Trim Packer | Nitro Gas / Foam Cell | HILFR05/HILFR05F | 2 | \$30.00 |
| 10mm Strut Trim Packer | Nitro Gas / Foam Cell | HILFR10/HILFR10F | 2 | \$30.00 |
| 15mm Strut Trim Packer | Nitro Gas / Foam Cell | HILFR15/HILFR15F | 2 | \$30.00 |

• ONLY Compatible with Ironman 4x4 Struts (except Pro), lift height subject to 2:1 motion ratio. Unnecessary fitment may lift vehicle too high

REAR SUSPENSION

SHOCK ABSORBER

| | | | | | |
|-------------------------|--|--|-----------------|---|----------|
| Nitro Gas - Performance | | | 12645GRS | 2 | \$160.00 |
| Foam Cell - Performance | | | 24645FES | 2 | \$232.00 |

COIL SPRINGS

| | Est. Lift | Additional Load | | | |
|----------|-----------|-----------------|-----------------|---|----------|
| Standard | 0mm | 0 - 250kg | MITS042S | 1 | \$262.00 |
| Light | 20mm | 0 - 250kg | MITS042A | 1 | \$262.00 |
| Medium | 40mm | 0 - 250kg | MITS042B | 1 | \$262.00 |
| Heavy | 40mm | 250kg - GVM | MITS042C | 1 | \$262.00 |

SUSPENSION KIT - Specify Front Coil Springs When Ordering

| | | |
|----------------------|-------------------|-----------|
| Standard - Nitro Gas | MITS042SKG | \$1304.00 |
| Standard - Foam Cell | MITS042SKF | \$1506.00 |
| Light - Nitro Gas | MITS042AKG | \$1304.00 |
| Light - Foam Cell | MITS042AKF | \$1506.00 |
| Medium - Nitro Gas | MITS042BKG | \$1304.00 |
| Medium - Foam Cell | MITS042BKF | \$1506.00 |
| Heavy - Nitro Gas | MITS042CKG | \$1304.00 |
| Heavy - Foam Cell | MITS042CKF | \$1506.00 |

SUSPENSION KIT CONTENTS

| | |
|-----------------------|--------------|
| Shock Absorbers | Coil Springs |
| Strut Shock Absorbers | |



Challenger / Montero Sport PA (Coil)
1998 to 2008

Mitsubishi Pajero

Product Description

Part No.

Qty
ReqRetail
ea Inc GST

Please check vehicle date range (if shown) next to product description prior to ordering

SUSPENSION TO SUIT MITSUBISHI PAJERO - 1998-2008

FRONT SUSPENSION

SHOCK ABSORBER

| | | | |
|-------------------------|----------------|---|----------|
| Nitro Gas - Performance | 12087GR | 2 | \$160.00 |
| Foam Cell - Performance | 24087FE | 2 | \$232.00 |

TORSION BAR

| | | | |
|----------------------|----------------|---|----------|
| Uprated Torsion Bars | MITS019 | 1 | \$435.00 |
|----------------------|----------------|---|----------|

• Minimum 60mm downward suspension travel required after adjustment

REAR SUSPENSION

SHOCK ABSORBER

| | | | |
|-------------------------|-----------------|---|----------|
| Nitro Gas - Comfort | 12645GRC | 2 | \$160.00 |
| Nitro Gas - Performance | 12645GR | 2 | \$160.00 |
| Foam Cell - Comfort | 24645FEC | 2 | \$232.00 |
| Foam Cell - Performance | 24645FE | 2 | \$232.00 |

COIL SPRINGS

| | Est. Lift | Additional Load | | | |
|-------------|-----------|-----------------|-----------------|---|----------|
| Medium | 40mm | 0 - 200kg | MITS022B | 1 | \$262.00 |
| Heavy | 40mm | 200-400kg | MITS020B | 1 | \$262.00 |
| Extra Heavy | 40mm | 400kg - GVM | MITS020C | 1 | \$262.00 |

SUSPENSION KIT

| | | |
|-------------------------|-------------------|-----------|
| Medium - Nitro Gas | MITS022BKG | \$1333.00 |
| Medium - Foam Cell | MITS022BKF | \$1622.00 |
| Heavy - Nitro Gas | MITS020BKG | \$1333.00 |
| Heavy - Foam Cell | MITS020BKF | \$1622.00 |
| Extra Heavy - Nitro Gas | MITS020CKG | \$1333.00 |
| Extra Heavy - Foam Cell | MITS020CKF | \$1622.00 |

SUSPENSION KIT CONTENTS

| | |
|-----------------|--------------|
| Shock Absorbers | Torsion Bars |
| Coil Springs | |

Mitsubishi Pajero

Montero Sport (Leaf)
1998 to 2006



Product Description

Part No.

Qty
Req

Retail
ea Inc GST

Please check vehicle date range (if shown) next to product description prior to ordering

SUSPENSION TO SUIT MITSUBISHI PAJERO - 1998-2006

FRONT SUSPENSION

SHOCK ABSORBER

| | | | |
|-------------------------|----------------|---|----------|
| Nitro Gas - Performance | 12087GR | 2 | \$160.00 |
| Foam Cell - Performance | 24087FE | 2 | \$232.00 |

TORSION BAR

| | | | |
|-----------------------|----------------|---|----------|
| Up-rated Torsion Bars | MITSO19 | 1 | \$435.00 |
|-----------------------|----------------|---|----------|

• Minimum 60mm downward suspension travel required after adjustment

REAR SUSPENSION

SHOCK ABSORBER

| | | | |
|--------------------------|-----------------|---|----------|
| Nitro Gas - Comfort | 12636GRC | 2 | \$160.00 |
| Nitro Gas - Performance | 12636GR | 2 | \$160.00 |
| Nitro Gas - Professional | 12636GRP | 2 | \$160.00 |
| Foam Cell - Comfort | 24636FEC | 2 | \$232.00 |
| Foam Cell - Performance | 24636FE | 2 | \$232.00 |
| Foam Cell - Professional | 24636FEP | 2 | \$232.00 |

LEAF SPRINGS

| | Est. Lift | Additional Load | | |
|--------|-----------|-----------------|-----------------|---|
| Medium | 40mm | 0 - 300kg | MITSO18B | 2 |
| Heavy | 40mm | 300kg - GVM | MITSO18C | 2 |

• Must use Ironman 4x4 bushes

U-BOLTS

| | | | |
|------------|---------------|---|---------|
| U-Bolt Kit | 451UBK | 2 | \$44.00 |
|------------|---------------|---|---------|

POLYURETHANE SPRING BUSHES

| | | | |
|----------|----------------|---|---------|
| Bush Kit | 715STUK | 1 | \$88.00 |
|----------|----------------|---|---------|

• Not compatible with OEM springs

GREASABLE SHACKLES AND PINS

| | | | |
|-------------------|------------|---|---------|
| Greasable Shackle | 795 | 2 | \$59.00 |
| Greasable Pin | 796 | 2 | \$30.00 |

HELPER SPRINGS

| | | | |
|--------------------------|------------|---|----------|
| Load Plus Helper Springs | LP4 | 1 | \$165.00 |
|--------------------------|------------|---|----------|

SUSPENSION KIT

| | | |
|--------------------|-------------------|-----------|
| Medium - Nitro Gas | MITSO18BKG | \$2028.00 |
| Medium - Foam Cell | MITSO18BKF | \$2317.00 |
| Heavy - Nitro Gas | MITSO18CKG | \$2085.00 |
| Heavy - Foam Cell | MITSO18CKF | \$2375.00 |

SUSPENSION KIT CONTENTS

| | | |
|-----------------|--------------|----------------------------|
| Shock Absorbers | Torsion Bars | Polyurethane Spring Bushes |
| Leaf Springs | U-Bolts | |



L400
1994+

Mitsubishi Delica

Product Description

Part No.

Qty
Req

Retail
ea Inc GST

Please check vehicle date range (if shown) next to product description prior to ordering

SUSPENSION TO SUIT MITSUBISHI DELICA - 1994+

FRONT SUSPENSION

SHOCK ABSORBER

| | | | | |
|-------------------------|--|----------------|---|----------|
| Nitro Gas - Performance | | 12667GR | 2 | \$160.00 |
| Foam Cell - Performance | | 24667FE | 2 | \$232.00 |

TORSION BAR

| | | | | |
|----------------------|--|----------------|---|----------|
| Uprated Torsion Bars | | MITS031 | 1 | \$435.00 |
|----------------------|--|----------------|---|----------|

- Torsion Bars suit vehicles 5/1994-5/1999 only
- Minimum 60mm downward suspension travel required after adjustment

REAR SUSPENSION

SHOCK ABSORBER

| | | | | |
|-------------------------|-------------|----------------|---|----------|
| Nitro Gas - Performance | Without ECS | 12698GR | 2 | \$160.00 |
| Nitro Gas - Performance | With ECS | 12671GR | 2 | \$160.00 |

- ECS - Electronic Control Suspension

COIL SPRINGS

| | Est. Lift | Additional Load | | |
|--------|-----------|-----------------|-----------------|---|
| Medium | 40mm | 0 - 250kg | MITS025B | 1 |

SUSPENSION KIT

| | | | | |
|--------------------|-------------|--------------------|--|-----------|
| Medium - Nitro Gas | Without ECS | MITS031BKG | | \$1333.00 |
| Medium - Nitro Gas | With ECS | MITS031BKG1 | | \$1333.00 |

- Shock Absorbers do not re-connect to ECS system

SUSPENSION KIT CONTENTS

Shock Absorbers Coil Springs Torsion Bars





Product Description

Part No.

Qty
ReqRetail
ea Inc GST

Please check vehicle date range (if shown) next to product description prior to ordering

ACCESSORIES TO SUIT MITSUBISHI TRITON MR - 11/2018+

STEEL WINCH BULL BARS (INCLUDING GLS PREMIUM)

| | | |
|---|-----------|-----------|
| Commercial | BBC067 | \$1754.00 |
| Commercial Deluxe | BBCD067 | \$2387.00 |
| Proguard No Loop | BBT067-NL | \$1973.00 |
| Proguard Single Loop Kit | BB067-SL | \$352.00 |
| Proguard Triple Loop Kit | BB067-TL | \$423.00 |
| Driving Light / Lightbar Patch Loom - Factory LED Headlight models only | IPL067 | \$33.00 |
| Load Resistor Kit with Mounting Brackets for Indicator / Parker Replacement | LR12V21W | \$52.00 |

• Winch with Steel Cable and Roller Fairlead is not suitable - Use Winch with Synthetic Rope and Alloy Hawse only

STEEL SIDE STEPS AND RAILS - FITS DUAL AND CLUB CAB

| | | |
|----------------------|------------|-----------|
| Side Steps | SS050 | \$1006.00 |
| Side Rails | SS050 RAIL | \$332.00 |
| Side Steps and Rails | SSR050 | \$1207.00 |

TOWING (GLS MODEL ONLY)

| | | |
|---|-------------|-----------|
| Class 4 Towbar - Compatible with Factory Rear Bumper | TB050 | \$608.00 |
| Rear Protection Towbar - Full Rear Bumper Replacement | RTB067GLS | \$1388.00 |
| Rear Protection Towbar Plates (Pair) | RTBPLATE050 | \$153.00 |
| Towbar Wiring Loom - Plug and Play | ITBL067 | \$468.00 |

TOWING (NOT GLS MODEL)

| | | |
|---|-------------|-----------|
| Class 4 Towbar - Compatible with Factory Rear Bumper | TB050 | \$608.00 |
| Rear Protection Towbar - Full Rear Bumper Replacement | RTB067GLX | \$1388.00 |
| Rear Protection Towbar Plates (Pair) | RTBPLATE050 | \$153.00 |
| Towbar Wiring Loom - Plug and Play | ITBL067 | \$468.00 |

RECOVERY POINTS - IRONMAN 4X4 BULL BAR ONLY

| | | |
|---|--------|----------|
| Recovery Points - 5000kg Rating (Pair) (Includes GLS Premium) | IRP059 | \$340.00 |
|---|--------|----------|

SNORKEL

| | | |
|---|-------------|----------|
| MR Triton - GLS and GSR only. Not compatible with GLX model | ISNORKEL067 | \$437.00 |
|---|-------------|----------|

BATTERY TRAY

| | | |
|-------------------|-----------|----------|
| Suits 12" Battery | IBTRAY050 | \$240.00 |
|-------------------|-----------|----------|

LONG RANGE FUEL TANK

| | | |
|--|---------|-----------|
| 125L* Diesel only - Fits Dual and Extra Cab only | TANK004 | \$1180.00 |
|--|---------|-----------|

* Usable volume may differ to the stated tank capacity

PREMIUM UNDERBODY PROTECTION

| | | |
|-----------------------------|--------|----------|
| Engine Bay and Transmission | UBP050 | \$782.00 |
|-----------------------------|--------|----------|

UNDERBODY PROTECTION

| | | |
|--|---------|----------|
| Engine Bay and Transmission - Not compatible with bull bars. - While Stocks Last | IUP050K | \$563.00 |
|--|---------|----------|

LOCKSAFE DRAWER SYSTEMS

| | | |
|------------------------|---------|-----------|
| Twin Drawers - 1300mm | ITD1300 | \$1536.00 |
| Single Drawer - 1300mm | ISD1300 | \$932.00 |
| Wing Kit - 1300mm* | ITDW050 | \$367.00 |

*Designed to suit factory tubs, will not suit ute liner without modification.



MR
11/2018+

Mitsubishi Triton

| Product Description | Part No. | Qty Req | Retail ea Inc GST |
|---|-------------------|------------|----------------------|
| CANOPY - ABS PLASTIC (SIDE LIFT UP WINDOWS AND CENTRAL LOCKING REAR DOOR) - FITS 4X4 AND 4X2 DUAL CAB MODELS | | | |
| Pre Primed | CANOPY014-P | | \$3238.00 |
| ABS Canopy Rack Feet | IRRFETABS14 | | \$287.00 |
| • See Page 38 for 1.4m Roof Rack options and pricing. | | | |
| CANOPY - PINNACLE SMOOTH FINISH FIBREGLASS (SIDE LIFT UP WINDOWS AND CENTRAL LOCKING REAR DOOR) - FITS 4X4 AND 4X2 DUAL CAB MODELS | | | |
| Black Mica (X08) | CANFIBRE050-BM | | \$3763.00 |
| Impulse Blue (D23) | CANFIBRE050-IB | | \$3763.00 |
| Graphite Grey (U28) | CANFIBRE050-GG | | \$3763.00 |
| Sterling Silver (U25) | CANFIBRE050-SS | | \$3763.00 |
| White Solid (W32) | CANFIBRE050-WS | | \$3763.00 |
| CANOPY - PINNACLE 2 FIBREGLASS (SIDE LIFT UP WINDOWS AND CENTRAL LOCKING REAR DOOR) - FITS 4X4 AND 4X2 DUAL CAB MODELS | | | |
| Pre-Primed | ICANOPY050-P | | \$3213.00 |
| Black Mica (X08) | ICANOPY050-BM | | \$3763.00 |
| Graphite Grey (U28) | ICANOPY050-GG | | \$3763.00 |
| Impulse Blue (D23) | ICANOPY050-IB | | \$3763.00 |
| Sterling Silver (U25) | ICANOPY050-SS | | \$3763.00 |
| Titanium Grey (U17) | ICANOPY050-TG | | \$3763.00 |
| White Solid (W32) | ICANOPY050-WS | | \$3763.00 |
| * Pre-primed canopies, plus colour coding. | | | |
| SLIDE-AWAY ROLL UP HARD TONNEAU COVER | | | |
| Electric with Remote Control | ISLIDEAWAY067-E | | \$2716.00 |
| Sports Bar Adaptor | ISLIDEAWAY067-SBA | | \$135.00 |
| ATLAS DUAL CAB ROOF RACK KITS | | | |
| Platform A with Blade Fit Kit (Dual Cab Only) - 1530mm Length | IFR067PAK | | \$1608.00 |
| Crossbar (x 2) and Fit Kit (Dual Cab) - 1250mm Width | IFR067C2K | | \$616.00 |
| Platform K with Leg Fit Kit to Suit Pinnacle 2 Canopy - 1390mm Length | IFRP2PKK | | \$1294.00 |
| Crossbar (x 2) and Fit Kit to Suit Pinnacle 2 Canopy - 1250mm Width | IFRP2C125K | | \$564.00 |
| Platform S with Blade Fit Kit to Suit Slideaway Hard Tonneau Cover - 1390mm Length | IFRSLDAWAYPSK | | \$1670.00 |
| Crossbar (x 2) and Fit Kit to Suit Slideaway Hard Tonneau Cover - 1500mm Width | IFRSLDAWAYC2K | | \$940.00 |
| • See Page 36 and 37 for more Atlas rack and crossbar options. | | | |
| FENDER FLARE KITS | | | |
| Matte Black Smooth Finish 6" (Suits Dual Cab) | IFF6067 | | \$499.00 |
| SEAT COVER | | | |
| Canvas Comfort - Front | ICSC050F | | \$420.00 |
| Canvas Comfort - Rear | ICSC050R | | \$420.00 |
| BREATHER KIT | | | |
| Universal Twin Manifold Filtered Breather Kit | IDIFFBRE | | \$115.00 |

LISTING
CONTINUED
OVER THE
PAGE



Product Description

Part No.

Qty
Req

Retail
ea Inc GST

Please check vehicle date range (if shown) next to product description prior to ordering

SUSPENSION TO SUIT MITSUBISHI TRITON MR - 11/2018+

FRONT SUSPENSION

SHOCK ABSORBER

| | | | | | |
|---|--|--|----------------|---|----------|
| Nitro Gas Strut - Performance | | | 12715GR | 2 | \$232.00 |
| Foam Cell Strut - Performance | | | 24715FE | 2 | \$262.00 |
| Foam Cell Pro Strut - Performance* (SEE NOTE) | | | 45715FE | 2 | \$406.00 |

*NOTE: MANDATORY FITMENT of UCA050FA and MITS045B /C Coil Springs with 45715FE

COIL SPRINGS

| | Est. Lift | Additional Load | | | |
|--------------------|-----------|-----------------|-------------------|---|----------|
| Standard | 0mm | 0 - 50kg | MITS040S | 1 | \$262.00 |
| Light | 25mm | 0 - 50kg | MITS040A | 1 | \$262.00 |
| Medium | 30mm | 0 - 80kg | MITS040B | 1 | \$262.00 |
| Medium* (SEE NOTE) | 50mm | 0 - 80kg | MITS045B * | 1 | \$262.00 |
| Heavy | 30mm | 80 - 110kg | MITS040C | 1 | \$262.00 |
| Heavy* (SEE NOTE) | 50mm | 80 - 110kg | MITS045C * | 1 | \$262.00 |

*NOTE: MANDATORY FITMENT of UCA050FA and 45715FE with (MITS045B /C) Coil Springs

STRUT MOUNTS

| | | | | | |
|-----------------|--|--|----------------|---|----------|
| Steel Strut Top | | | ISST010 | 2 | \$102.00 |
|-----------------|--|--|----------------|---|----------|

TRIM PACKERS

| | | | | |
|------------------------|-----------------------|-------------------------|---|---------|
| 5mm Strut Trim Packer | Nitro Gas / Foam Cell | HILFR05/HILFR05F | 2 | \$30.00 |
| 10mm Strut Trim Packer | Nitro Gas / Foam Cell | HILFR10/HILFR10F | 2 | \$30.00 |
| 15mm Strut Trim Packer | Nitro Gas / Foam Cell | HILFR15/HILFR15F | 2 | \$30.00 |

• ONLY Compatible with Ironman 4x4 Struts, lift height subject to 2:1 motion ratio. Unnecessary fitment may lift vehicle too high

CONTROL ARMS

| | | | | | |
|------------------------------|--|--|-----------------|---|----------|
| Pro-Forge Upper Control Arms | | | UCA050FA | 1 | \$882.00 |
|------------------------------|--|--|-----------------|---|----------|





MR L200
11/2018+

Mitsubishi Triton

Product Description

Part No.

**Qty
Req**

**Retail
ea Inc GST**

Please check vehicle date range (if shown) next to product description prior to ordering

REAR SUSPENSION

SHOCK ABSORBER

| | | | | | |
|------------------------------|--|--|-----------------|---|----------|
| Nitro Gas - Comfort | | | 12729GRC | 2 | \$160.00 |
| Nitro Gas - Performance | | | 12729GR | 2 | \$160.00 |
| Nitro Gas - Professional | | | 12729GRP | 2 | \$160.00 |
| Foam Cell - Comfort | | | 24729FEC | 2 | \$232.00 |
| Foam Cell - Performance | | | 24729FE | 2 | \$232.00 |
| Foam Cell - Professional | | | 24729FEP | 2 | \$232.00 |
| Foam Cell Pro - Comfort | | | 45729FEC | 2 | \$319.00 |
| Foam Cell Pro - Performance | | | 45729FE | 2 | \$319.00 |
| Foam Cell Pro - Professional | | | 45729FEP | 2 | \$319.00 |

LEAF SPRINGS

| | Est. Lift | Additional Load | | | |
|--------|-----------|-----------------|-----------------|---|----------|
| Light | 30mm | 0 - 200kg | MITSO47A | 2 | \$392.00 |
| Medium | 30mm | 0 - 300kg | MITSO47B | 2 | \$392.00 |
| Heavy | 30mm | 300kg - GVM | MITSO47C | 2 | \$421.00 |

• Two piece tailshaft models may experience driveline vibration, use 1201K to reduce vibration.

U-BOLTS

| | | | | | |
|------------|----------------|--|----------------|---|---------|
| U-Bolt Kit | | | 437UBK | 2 | \$44.00 |
| U-Bolt Kit | Suits MITSO47C | | 437UBKL | 2 | \$44.00 |

POLYURETHANE SPRING BUSHES

| | | | | | |
|----------|--|--|---------------|---|---------|
| Bush Kit | | | 1200UK | 1 | \$88.00 |
|----------|--|--|---------------|---|---------|

DRIVELINE SPACERS

| | | | | | |
|---------------------------|--|--|--------------|---|----------|
| Centre Bearing Spacer Kit | | | 1201K | 1 | \$116.00 |
|---------------------------|--|--|--------------|---|----------|

SPACER KIT

| | | | | | |
|---------------------------|--|--|--------------|---|---------|
| Brake Hose Relocation Kit | | | 1205K | 1 | \$59.00 |
|---------------------------|--|--|--------------|---|---------|

GREASABLE SHACKLES AND PINS

| | | | | | |
|-------------------|--|--|--------------|---|---------|
| Greasable Shackle | | | 1199 | 2 | \$59.00 |
| Non-Greasable Pin | | | 387-1 | 2 | \$30.00 |

HELPER SPRINGS

| | | | | | |
|------------|--|--|----------------|---|----------|
| Add-A-Leaf | | | ISL6010 | 1 | \$175.00 |
|------------|--|--|----------------|---|----------|

SUSPENSION KIT - Specify Front Coil Springs When Ordering

| | | |
|------------------------|-------------------|-----------|
| Light - Nitro Gas | MITSO47AKG | \$2172.00 |
| Light - Foam Cell | MITSO47AKF | \$2375.00 |
| Medium - Nitro Gas | MITSO47BKG | \$2172.00 |
| Medium - Foam Cell | MITSO47BKF | \$2375.00 |
| Medium - Foam Cell Pro | MITSO47BKP | \$3759.00 |
| Heavy - Nitro Gas | MITSO47CKG | \$2231.00 |
| Heavy - Foam Cell | MITSO47CKF | \$2433.00 |
| Heavy - Foam Cell Pro | MITSO47CKP | \$3817.00 |

• Two piece tailshaft models may experience driveline vibration, use 1201K to reduce vibration

SUSPENSION KIT CONTENTS

| | | | |
|-----------------------|--------------|--|---------------------------|
| Shock Absorbers | Coil Springs | Upper Control Arms (Foam Cell Pro Kits Only) | Brake Hose Relocation Kit |
| Leaf Springs | U-Bolts | Polyurethane Spring Bushes | Centre Bearing Spacer Kit |
| Strut Shock Absorbers | | | |





Product Description

Part No.

Qty
Req

Retail
ea Inc GST

Please check vehicle date range (if shown) next to product description prior to ordering

ACCESSORIES TO SUIT MITSUBISHI TRITON MQ - 2015-10/2018

| Product Description | Part No. | Qty Req | Retail ea Inc GST |
|---|-------------|---------|-------------------|
| STEEL WINCH BULL BARS | | | |
| Commercial | BBC050 | | \$1754.00 |
| Commercial Deluxe | BBCD050 | | \$2387.00 |
| Polished Alloy | BBA050 | | \$2472.00 |
| Proguard No Loop | BBT050-NL | | \$1973.00 |
| Proguard Single Loop Kit | BB050-SL | | \$352.00 |
| Proguard Triple Loop Kit | BB050-TL | | \$423.00 |
| Driving Light / Lightbar Patch Loom - Factory LED Headlight models only | IPL050 | | \$33.00 |
| STEEL SIDE STEPS AND RAILS - FITS DUAL AND CLUB CAB | | | |
| Side Steps | SS050 | | \$1006.00 |
| Side Rails | SS050 RAIL | | \$332.00 |
| Side Steps and Rails | SSR050 | | \$1207.00 |
| TOWING | | | |
| Class 4 Towbar - Compatible with Factory Rear Bumper | TB050 | | \$608.00 |
| Rear Protection Towbar - Full Rear Bumper Replacement | RTB050 | | \$1388.00 |
| Rear Protection Towbar Plates (Pair) | RTBPLATE050 | | \$153.00 |
| Towbar Wiring Loom - Plug and Play | ITBL050 | | \$276.00 |
| RECOVERY POINTS - IRONMAN 4X4 BULL BAR ONLY | | | |
| Recovery Points - 5000kg Rating (Pair) | IRP050 | | \$300.00 |
| SNORKEL | | | |
| Triton MQ 2015-10/2018 Only - Suits 2.4L Diesel Only | ISNORKEL050 | | \$437.00 |
| BATTERY TRAY | | | |
| Suits 12" Battery | IBTRAY050 | | \$240.00 |
| LONG RANGE FUEL TANK | | | |
| 125L* Diesel only - Fits Dual and Extra Cab only | TANK004 | | \$1180.00 |
| <i>* Usable volume may differ to the stated tank capacity</i> | | | |
| PREMIUM UNDERBODY PROTECTION | | | |
| Engine Bay and Transmission | UBP050 | | \$782.00 |
| UNDERBODY PROTECTION | | | |
| Engine Bay and Transmission - Not compatible with bull bars. - <i>While Stocks Last</i> | IUP050K | | \$563.00 |
| LOCKSAFE DRAWER SYSTEMS | | | |
| Twin Drawers - 1300mm | ITD1300 | | \$1536.00 |
| Single Drawer - 1300mm | ISD1300 | | \$932.00 |
| Wing Kit - 1300mm* | ITDW050 | | \$367.00 |
| <i>*Designed to suit factory tubs, will not suit ute liner without modification.</i> | | | |



MQ
2015 to 10/2018

Mitsubishi Triton

| Product Description | Part No. | Qty Req | Retail ea Inc GST |
|---|-------------------|------------|----------------------|
| CANOPY - ABS PLASTIC (SIDE LIFT UP WINDOWS AND CENTRAL LOCKING REAR DOOR) - FITS 4X4 AND 4X2 DUAL CAB MODELS | | | |
| Pre Primed | CANOPY014-P | | \$3238.00 |
| ABS Canopy Rack Feet | IRRFEETABS14 | | \$287.00 |
| • See Page 38 for 1.4m Roof Rack options and pricing. | | | |
| CANOPY - PINNACLE SMOOTH FINISH FIBREGLASS (SIDE LIFT UP WINDOWS AND CENTRAL LOCKING REAR DOOR) - FITS 4X4 AND 4X2 DUAL CAB MODELS | | | |
| Black Mica (X08) | CANFIBRE050-BM | | \$3763.00 |
| Impulse Blue (D23) | CANFIBRE050-IB | | \$3763.00 |
| Titanium Grey (U17) | CANFIBRE050-TG | | \$3763.00 |
| Sterling Silver (U25) | CANFIBRE050-SS | | \$3763.00 |
| White Solid (W32) | CANFIBRE050-WS | | \$3763.00 |
| CANOPY - PINNACLE 2 FIBREGLASS (SIDE LIFT UP WINDOWS AND CENTRAL LOCKING REAR DOOR) - FITS 4X4 AND 4X2 DUAL CAB MODELS | | | |
| Pre-Primed | ICANOPY050-P | | \$3213.00 |
| Black Mica (X08) | ICANOPY050-BM | | \$3763.00 |
| Graphite Grey (U28) | ICANOPY050-GG | | \$3763.00 |
| Impulse Blue (D23) | ICANOPY050-IB | | \$3763.00 |
| Sterling Silver (U25) | ICANOPY050-SS | | \$3763.00 |
| Titanium Grey (U17) | ICANOPY050-TG | | \$3763.00 |
| White Solid (W32) | ICANOPY050-WS | | \$3763.00 |
| * Pre-primed canopies, plus colour coding. | | | |
| SLIDE-AWAY ROLL UP HARD TONNEAU COVER | | | |
| Electric with Remote Control | ISLIDEAWAY067-E | | \$2716.00 |
| Sports Bar Adaptor | ISLIDEAWAY067-SBA | | \$135.00 |
| ATLAS DUAL CAB ROOF RACK KITS | | | |
| Platform A with Blade Fit Kit (Dual Cab Only) - 1530mm Length | IFR067PAK | | \$1608.00 |
| Crossbar (x 2) and Fit Kit (Dual Cab) - 1250mm Width | IFR067C2K | | \$616.00 |
| Platform K with Leg Fit Kit to Suit Pinnacle 2 Canopy - 1390mm Length | IFRP2PKK | | \$1294.00 |
| Crossbar (x 2) and Fit Kit to Suit Pinnacle 2 Canopy - 1250mm Width | IFRP2C125K | | \$564.00 |
| Platform S with Blade Fit Kit to Suit Slideaway Hard Tonneau Cover - 1390mm Length | IFRSLDAWAYPSK | | \$1670.00 |
| Crossbar (x 2) and Fit Kit to Suit Slideaway Hard Tonneau Cover - 1500mm Width | IFRSLDAWAYC2K | | \$940.00 |
| • See Page 36 and 37 for more Atlas rack and crossbar options. | | | |
| FENDER FLARE KITS | | | |
| Matte Black Smooth Finish 6" (Suits Dual Cab) | IFF6050 | | \$499.00 |
| SEAT COVER | | | |
| Canvas Comfort - Front | ICSC050F | | \$420.00 |
| Canvas Comfort - Rear | ICSC050R | | \$420.00 |
| BREATHER KIT | | | |
| Universal Twin Manifold Filtered Breather Kit | IDIFFBRE | | \$115.00 |

LISTING
CONTINUED
OVER THE
PAGE





Product Description

Part No.

Qty
Req

Retail
ea Inc GST

Please check vehicle date range (if shown) next to product description prior to ordering

SUSPENSION TO SUIT MITSUBISHI TRITON MQ - 2015-10/2018

FRONT SUSPENSION

SHOCK ABSORBER

| | | | | | |
|---|--|--|----------------|---|----------|
| Nitro Gas Strut - Performance | | | 12715GR | 2 | \$232.00 |
| Foam Cell Strut - Performance | | | 24715FE | 2 | \$262.00 |
| Foam Cell Pro Strut - Performance* (SEE NOTE) | | | 45715FE | 2 | \$406.00 |

*NOTE: MANDATORY FITMENT of UCA050FA and MITS045B /C Coil Springs with 45715FE

COIL SPRINGS

| | Est. Lift | Additional Load | | | |
|--------------------|-----------|-----------------|-------------------|---|----------|
| Standard | 0mm | 0 - 50kg | MITS040S | 1 | \$262.00 |
| Light | 25mm | 0 - 50kg | MITS040A | 1 | \$262.00 |
| Medium | 30mm | 0 - 80kg | MITS040B | 1 | \$262.00 |
| Medium* (SEE NOTE) | 50mm | 0 - 80kg | MITS045B * | 1 | \$262.00 |
| Heavy | 30mm | 80 - 110kg | MITS040C | 1 | \$262.00 |
| Heavy* (SEE NOTE) | 50mm | 80 - 110kg | MITS045C * | 1 | \$262.00 |

*NOTE: MANDATORY FITMENT of UCA050FA and 45715FE with (MITS045B /C) Coil Springs

STRUT MOUNTS

| | | | | | |
|-----------------|--|--|----------------|---|----------|
| Steel Strut Top | | | ISST010 | 2 | \$102.00 |
|-----------------|--|--|----------------|---|----------|

TRIM PACKERS

| | | | | |
|------------------------|-----------------------|-------------------------|---|---------|
| 5mm Strut Trim Packer | Nitro Gas / Foam Cell | HILFR05/HILFR05F | 2 | \$30.00 |
| 10mm Strut Trim Packer | Nitro Gas / Foam Cell | HILFR10/HILFR10F | 2 | \$30.00 |
| 15mm Strut Trim Packer | Nitro Gas / Foam Cell | HILFR15/HILFR15F | 2 | \$30.00 |

• ONLY Compatible with Ironman 4x4 Struts, lift height subject to 2:1 motion ratio. Unnecessary fitment may lift vehicle too high

CONTROL ARMS

| | | | | | |
|------------------------------|--|--|-----------------|---|----------|
| Pro-Forge Upper Control Arms | | | UCA050FA | 1 | \$882.00 |
|------------------------------|--|--|-----------------|---|----------|





MQ L200
2015 to 10/2018

SUSPENSION TO SUIT

Mitsubishi Triton

Product Description

Part No.

Qty Req

Retail ea Inc GST

Please check vehicle date range (if shown) next to product description prior to ordering

REAR SUSPENSION

SHOCK ABSORBER

| | | | | | |
|------------------------------|--|--|-----------------|---|----------|
| Nitro Gas - Comfort | | | 12729GRC | 2 | \$160.00 |
| Nitro Gas - Performance | | | 12729GR | 2 | \$160.00 |
| Nitro Gas - Professional | | | 12729GRP | 2 | \$160.00 |
| Foam Cell - Comfort | | | 24729FEC | 2 | \$232.00 |
| Foam Cell - Performance | | | 24729FE | 2 | \$232.00 |
| Foam Cell - Professional | | | 24729FEP | 2 | \$232.00 |
| Foam Cell Pro - Comfort | | | 45729FEC | 2 | \$319.00 |
| Foam Cell Pro - Performance | | | 45729FE | 2 | \$319.00 |
| Foam Cell Pro - Professional | | | 45729FEP | 2 | \$319.00 |

LEAF SPRINGS

| | Est. Lift | Additional Load | | | |
|--------|-----------|-----------------|-----------------|---|----------|
| Light | 30mm | 0 - 200kg | MITSO47A | 2 | \$392.00 |
| Medium | 30mm | 0 - 300kg | MITSO47B | 2 | \$392.00 |
| Heavy | 30mm | 300kg - GVM | MITSO47C | 2 | \$421.00 |

• Two piece tailshaft models may experience driveline vibration, use 1201K to reduce vibration.

U-BOLTS

| | | | | | |
|------------|--|----------------|----------------|---|---------|
| U-Bolt Kit | | | 437UBK | 2 | \$44.00 |
| U-Bolt Kit | | Suits MITSO47C | 437UBKL | 2 | \$44.00 |

POLYURETHANE SPRING BUSHES

| | | | | | |
|----------|--|--|---------------|---|---------|
| Bush Kit | | | 1200UK | 1 | \$88.00 |
|----------|--|--|---------------|---|---------|

DRIVELINE SPACERS

| | | | | | |
|---------------------------|--|--|--------------|---|----------|
| Centre Bearing Spacer Kit | | | 1201K | 1 | \$116.00 |
|---------------------------|--|--|--------------|---|----------|

SPACER KIT

| | | | | | |
|---------------------------|--|--|--------------|---|---------|
| Brake Hose Relocation Kit | | | 1205K | 1 | \$59.00 |
|---------------------------|--|--|--------------|---|---------|

GREASABLE SHACKLES AND PINS

| | | | | | |
|-------------------|--|--|--------------|---|---------|
| Greasable Shackle | | | 1199 | 2 | \$59.00 |
| Non-Greasable Pin | | | 387-1 | 2 | \$30.00 |

HELPER SPRINGS

| | | | | | |
|------------|--|--|----------------|---|----------|
| Add-A-Leaf | | | ISL6010 | 1 | \$175.00 |
|------------|--|--|----------------|---|----------|

SUSPENSION KIT - Specify Front Coil Springs When Ordering

| | | | |
|------------------------|--|-------------------|-----------|
| Light - Nitro Gas | | MITSO47AKG | \$2172.00 |
| Light - Foam Cell | | MITSO47AKF | \$2375.00 |
| Medium - Nitro Gas | | MITSO47BKG | \$2172.00 |
| Medium - Foam Cell | | MITSO47BKF | \$2375.00 |
| Medium - Foam Cell Pro | | MITSO47BKP | \$3759.00 |
| Heavy - Nitro Gas | | MITSO47CKG | \$2231.00 |
| Heavy - Foam Cell | | MITSO47CKF | \$2433.00 |
| Heavy - Foam Cell Pro | | MITSO47CKP | \$3817.00 |

• Two piece tailshaft models may experience driveline vibration, use 1201K to reduce vibration

SUSPENSION KIT CONTENTS

| | | | |
|-----------------------|--------------|--|---------------------------|
| Shock Absorbers | Coil Springs | Upper Control Arms (Foam Cell Pro Kits Only) | Brake Hose Relocation Kit |
| Leaf Springs | U-Bolts | Polyurethane Spring Bushes | Centre Bearing Spacer Kit |
| Strut Shock Absorbers | | | |



Reach for the Sky





MN
2009 to 2015

Mitsubishi Triton

Product Description

Part No.

Qty
Req

Retail
ea Inc GST

Please check vehicle date range (if shown) next to product description prior to ordering

ACCESSORIES TO SUIT MITSUBISHI TRITON MN - 2009-2015

STEEL WINCH BULL BARS

| | | |
|-------------------|---------|-----------|
| Commercial | BBC031 | \$1723.00 |
| Commercial Deluxe | BBCD031 | \$2345.00 |

• Can also be fitted to both 2WD and 4WD models.

STEEL SIDE STEPS AND RAILS - FITS DUAL CAB, EXTRA CAB AND SINGLE CAB

| | | |
|----------------------|--------|-----------|
| Side Steps | SS031 | \$1006.00 |
| Side Steps and Rails | SSR031 | \$1207.00 |

SNORKEL

| | | |
|--------|-------------|----------|
| Triton | ISNORKEL020 | \$437.00 |
|--------|-------------|----------|

LONG RANGE FUEL TANK

| | | |
|-----------------------------------|---------|-----------|
| 125L* Diesel - Fits Dual Cab only | TANK004 | \$1180.00 |
|-----------------------------------|---------|-----------|

| | | |
|-----------------------------------|---------|-----------|
| 125L* Petrol - Fits Dual Cab only | TANK005 | \$1180.00 |
|-----------------------------------|---------|-----------|

* Usable volume may differ to the stated tank capacity

• Modification required with factory rear diff-lock.

LOCKSAFE DRAWER SYSTEMS

| | | |
|-----------------------|---------|-----------|
| Twin Drawers - 1300mm | ITD1300 | \$1536.00 |
|-----------------------|---------|-----------|

| | | |
|------------------------|---------|----------|
| Single Drawer - 1300mm | ISD1300 | \$932.00 |
|------------------------|---------|----------|

| | | |
|--------------------|---------|----------|
| Wing Kit - 1300mm* | ITDW032 | \$367.00 |
|--------------------|---------|----------|

*Designed to suit factory tubs, will not suit ute liner without modification.

SEAT COVER

| | | |
|------------------------|----------|----------|
| Canvas Comfort - Front | ICSC031F | \$420.00 |
|------------------------|----------|----------|

| | | |
|-----------------------|----------|----------|
| Canvas Comfort - Rear | ICSC031R | \$420.00 |
|-----------------------|----------|----------|

BREATHER KIT

| | | |
|---|----------|----------|
| Universal Twin Manifold Filtered Breather Kit | IDIFFBRE | \$115.00 |
|---|----------|----------|

LISTING
CONTINUED
OVER THE
PAGE



Product Description

Part No.

Qty
Req

Retail
ea Inc GST

Please check vehicle date range (if shown) next to product description prior to ordering

SUSPENSION TO SUIT MITSUBISHI TRITON MN - 2009-2015

FRONT SUSPENSION

SHOCK ABSORBER

| | | | | | |
|---|--|--|----------------|---|----------|
| Nitro Gas Strut - Performance | | | 12715GR | 2 | \$232.00 |
| Foam Cell Strut - Performance | | | 24715FE | 2 | \$262.00 |
| Foam Cell Pro Strut - Performance* (SEE NOTE) | | | 45715FE | 2 | \$406.00 |

*NOTE: MANDATORY FITMENT of UCA050FA and MITS045B /C Coil Springs with 45715FE

COIL SPRINGS

| | Est. Lift | Additional Load | | | |
|--------------------|-----------|-----------------|-------------------|---|----------|
| Standard | 0mm | 0 - 50kg | MITS040S | 1 | \$262.00 |
| Light | 25mm | 0 - 50kg | MITS040A | 1 | \$262.00 |
| Medium | 30mm | 0 - 80kg | MITS040B | 1 | \$262.00 |
| Medium* (SEE NOTE) | 50mm | 0 - 80kg | MITS045B * | 1 | \$262.00 |
| Heavy | 30mm | 80 - 110kg | MITS040C | 1 | \$262.00 |
| Heavy* (SEE NOTE) | 50mm | 80 - 110kg | MITS045C * | 1 | \$262.00 |

*NOTE: MANDATORY FITMENT of UCA050FA and 45715FE with (MITS045B /C) Coil Springs

STRUT MOUNTS

| | | | | | |
|-----------------|--|--|---------------|---|----------|
| Steel Strut Top | | | ISS010 | 2 | \$102.00 |
|-----------------|--|--|---------------|---|----------|

TRIM PACKERS

| | | | | |
|------------------------|-----------------------|-------------------------|---|---------|
| 5mm Strut Trim Packer | Nitro Gas / Foam Cell | HILFR05/HILFR05F | 2 | \$30.00 |
| 10mm Strut Trim Packer | Nitro Gas / Foam Cell | HILFR10/HILFR10F | 2 | \$30.00 |
| 15mm Strut Trim Packer | Nitro Gas / Foam Cell | HILFR15/HILFR15F | 2 | \$30.00 |

CONTROL ARMS

| | | | | | |
|------------------------------|--|--|-----------------|---|----------|
| Pro-Forge Upper Control Arms | | | UCA050FA | 1 | \$882.00 |
|------------------------------|--|--|-----------------|---|----------|





MN L200
2009 to 2015

Mitsubishi Triton

Product Description

Part No.

Qty Req

Retail ea Inc GST

Please check vehicle date range (if shown) next to product description prior to ordering

REAR SUSPENSION

SHOCK ABSORBER

| | | | | | |
|------------------------------|--|--|-----------------|---|----------|
| Nitro Gas - Comfort | | | 12636GRC | 2 | \$160.00 |
| Nitro Gas - Performance | | | 12636GR | 2 | \$160.00 |
| Nitro Gas - Professional | | | 12636GRP | 2 | \$160.00 |
| Foam Cell - Comfort | | | 24636FEC | 2 | \$232.00 |
| Foam Cell - Performance | | | 24636FE | 2 | \$232.00 |
| Foam Cell - Professional | | | 24636FEP | 2 | \$232.00 |
| Foam Cell Pro - Comfort | | | 45636FEC | 2 | \$319.00 |
| Foam Cell Pro - Performance | | | 45636FE | 2 | \$319.00 |
| Foam Cell Pro - Professional | | | 45636FEP | 2 | \$319.00 |

LEAF SPRINGS

| | Est. Lift | Additional Load | | | |
|--------|-----------|-----------------|----------------|---|----------|
| Light | 40mm | 0 - 200kg | MTS041A | 2 | \$392.00 |
| Medium | 40mm | 0 - 300kg | MTS041B | 2 | \$392.00 |
| Heavy | 40mm | 300kg - GVM | MTS041C | 2 | \$421.00 |

• Must use Ironman 4x4 bushes.

• Unladen manual vehicles with 2 piece tail shaft may experience vibration in first gear.

U-BOLTS

| | | | | | |
|------------|--|--|----------------|---|---------|
| U-Bolt Kit | | | 1102UBK | 2 | \$44.00 |
|------------|--|--|----------------|---|---------|

POLYURETHANE SPRING BUSHES

| | | | | | |
|----------|--|--|---------------|---|---------|
| Bush Kit | | | 715TUK | 1 | \$88.00 |
|----------|--|--|---------------|---|---------|

• Not compatible with OEM springs

GREASABLE SHACKLES AND PINS

| | | | | | |
|-------------------|--|--|--------------|---|---------|
| Greasable Shackle | | | 795 | 2 | \$59.00 |
| Non-Greasable Pin | | | 387-1 | 2 | \$30.00 |

HELPER SPRINGS

| | | | | | |
|--------------------------|--|--|------------|---|----------|
| Load Plus Helper Springs | | | LP4 | 1 | \$165.00 |
|--------------------------|--|--|------------|---|----------|

SUSPENSION KIT - Specify Front Coil Springs When Ordering

| | | | | | |
|------------------------|--|--|------------------|--|-----------|
| Light - Nitro Gas | | | MTS041AKG | | \$1999.00 |
| Light - Foam Cell | | | MTS041AKF | | \$2201.00 |
| Medium - Nitro Gas | | | MTS041BKG | | \$1999.00 |
| Medium - Foam Cell | | | MTS041BKF | | \$2201.00 |
| Medium - Foam Cell Pro | | | MTS041BKP | | \$3678.00 |
| Heavy - Nitro Gas | | | MTS041CKG | | \$2056.00 |
| Heavy - Foam Cell | | | MTS041CKF | | \$2259.00 |
| Heavy - Foam Cell Pro | | | MTS041CKP | | \$3735.00 |

• Unladen manual vehicles with 2 piece tail shaft may experience vibration in first gear

SUSPENSION KIT CONTENTS

Shock Absorbers
Strut Shock Absorbers

Leaf Springs
Coil Springs

U-Bolts
Upper Control Arms (Foam Cell Pro Kits Only)

Polyurethane Spring Bushes

Mitsubishi Triton

ML
2006 to 2009



Product Description

Part No.

Qty
Req

Retail
ea Inc GST

Please check vehicle date range (if shown) next to product description prior to ordering

ACCESSORIES TO SUIT MITSUBISHI TRITON ML - 2006-2009

STEEL WINCH BULL BARS

| | | |
|--------------------------------------|---------|-----------|
| Commercial Deluxe | BBCD016 | \$2345.00 |
| Protector - <i>While Stocks Last</i> | BBT016 | \$2271.00 |

• Can also be fitted to both 2WD and 4WD models.

STEEL SIDE STEPS AND RAILS - FITS DUAL CAB AND EXTRA CAB MODELS ONLY

| | | |
|----------------------|--------|-----------|
| Side Steps and Rails | SSR031 | \$1207.00 |
|----------------------|--------|-----------|

LOCKSAFE DRAWER SYSTEMS

| | | |
|------------------------|---------|-----------|
| Twin Drawers - 1300mm | ITD1300 | \$1536.00 |
| Single Drawer - 1300mm | ISD1300 | \$932.00 |
| Wing Kit - 1300mm* | ITDW031 | \$367.00 |

*Designed to suit factory tubs, will not suit ute liner without modification.

SNORKEL

| | | |
|------------------------|-------------|----------|
| ML Triton 2006 to 2009 | ISNORKEL020 | \$437.00 |
|------------------------|-------------|----------|

LONG RANGE FUEL TANK

| | | |
|---|---------|-----------|
| 125L* Diesel (Not compatible with factory diff-lock) - Fits Dual Cab only | TANK004 | \$1180.00 |
| 125L* Petrol (Not compatible with factory diff-lock) - Fits Dual Cab only | TANK005 | \$1180.00 |

* Usable volume may differ to the stated tank capacity

• Modification required with factory rear diff-lock.

UNDERBODY PROTECTION

| | | |
|--------------------------------------|---------|----------|
| Fuel Tank - <i>While Stocks Last</i> | IUP010F | \$296.00 |
|--------------------------------------|---------|----------|

• Fuel tank protection plates are not compatible with long range fuel tanks.

SEAT COVER

| | | |
|------------------------|----------|----------|
| Canvas Comfort - Front | ICSC031F | \$420.00 |
| Canvas Comfort - Rear | ICSC031R | \$420.00 |

BREATHER KIT

| | | |
|---|----------|----------|
| Universal Twin Manifold Filtered Breather Kit | IDIFFBRE | \$115.00 |
|---|----------|----------|





ML L200
2006 to 2009

Mitsubishi Triton

Product Description

Part No.

Qty
Req

Retail
ea Inc GST

Please check vehicle date range (if shown) next to product description prior to ordering

SUSPENSION TO SUIT MITSUBISHI TRITON ML - 2006-2009

FRONT SUSPENSION

SHOCK ABSORBER

| | | | | | |
|---|--|--|----------------|---|----------|
| Nitro Gas Strut - Performance | | | 12715GR | 2 | \$232.00 |
| Foam Cell Strut - Performance | | | 24715FE | 2 | \$262.00 |
| Foam Cell Pro Strut - Performance* (SEE NOTE) | | | 45715FE | 2 | \$406.00 |

*NOTE: MANDATORY FITMENT of UCA050FA and MITS045B /C Coil Springs with 45715FE

COIL SPRINGS

| | Est. Lift | Additional Load | | | |
|--------------------|-----------|-----------------|-------------------|---|----------|
| Standard | 0mm | 0 - 50kg | MITSO40S | 1 | \$262.00 |
| Light | 25mm | 0 - 50kg | MITSO40A | 1 | \$262.00 |
| Medium | 30mm | 0 - 80kg | MITSO40B | 1 | \$262.00 |
| Medium* (SEE NOTE) | 50mm | 0 - 80kg | MITSO45B * | 1 | \$262.00 |
| Heavy | 30mm | 80 - 110kg | MITSO40C | 1 | \$262.00 |
| Heavy* (SEE NOTE) | 50mm | 80 - 110kg | MITSO45C * | 1 | \$262.00 |

*NOTE: MANDATORY FITMENT of UCA050FA and 45715FE with (MITSO45B /C) Coil Springs

STRUT MOUNTS

| | | | | | |
|-----------------|--|--|----------------|---|----------|
| Steel Strut Top | | | ISST010 | 2 | \$102.00 |
|-----------------|--|--|----------------|---|----------|

TRIM PACKERS

| | | | | | |
|------------------------|-----------------------|--|-------------------------|---|---------|
| 5mm Strut Trim Packer | Nitro Gas / Foam Cell | | HILFR05/HILFR05F | 2 | \$30.00 |
| 10mm Strut Trim Packer | Nitro Gas / Foam Cell | | HILFR10/HILFR10F | 2 | \$30.00 |
| 15mm Strut Trim Packer | Nitro Gas / Foam Cell | | HILFR15/HILFR15F | 2 | \$30.00 |

CONTROL ARMS

| | | | | | |
|------------------------------|--|--|-----------------|---|----------|
| Pro-Forge Upper Control Arms | | | UCA050FA | 1 | \$882.00 |
|------------------------------|--|--|-----------------|---|----------|

REAR SUSPENSION

SHOCK ABSORBER

| | | | | | |
|------------------------------|--|--|-----------------|---|----------|
| Nitro Gas - Comfort | | | 12636GRC | 2 | \$160.00 |
| Nitro Gas - Performance | | | 12636GR | 2 | \$160.00 |
| Nitro Gas - Professional | | | 12636GRP | 2 | \$160.00 |
| Foam Cell - Comfort | | | 24636FEC | 2 | \$232.00 |
| Foam Cell - Performance | | | 24636FE | 2 | \$232.00 |
| Foam Cell - Professional | | | 24636FEP | 2 | \$232.00 |
| Foam Cell Pro - Comfort | | | 45636FEC | 2 | \$319.00 |
| Foam Cell Pro - Performance | | | 45636FE | 2 | \$319.00 |
| Foam Cell Pro - Professional | | | 45636FEP | 2 | \$319.00 |

LEAF SPRINGS

| | Est. Lift | Additional Load | | | |
|--------|-----------|-----------------|-----------------|---|----------|
| Light | 40mm | 0 - 200kg | MITSO41A | 2 | \$392.00 |
| Medium | 40mm | 0 - 300kg | MITSO41B | 2 | \$392.00 |
| Heavy | 40mm | 300kg - GVM | MITSO41C | 2 | \$421.00 |

• Must use Ironman 4x4 bushes.

• Unladen manual vehicles with 2 piece tail shaft may experience vibration in first gear.

U-BOLTS

| | | | | | |
|------------|--|--|----------------|---|---------|
| U-Bolt Kit | | | 1102UBK | 2 | \$44.00 |
|------------|--|--|----------------|---|---------|

POLYURETHANE SPRING BUSHES

| | | | | | |
|----------|--|--|---------------|---|---------|
| Bush Kit | | | 715TUK | 1 | \$88.00 |
|----------|--|--|---------------|---|---------|

• Not compatible with OEM springs

GREASABLE SHACKLES AND PINS

| | | | | | |
|-------------------|--|--|--------------|---|---------|
| Greasable Shackle | | | 795 | 2 | \$59.00 |
| Non-Greasable Pin | | | 387-1 | 2 | \$30.00 |

HELPER SPRINGS

| | | | | | |
|--------------------------|--|--|------------|---|----------|
| Load Plus Helper Springs | | | LP4 | 1 | \$165.00 |
|--------------------------|--|--|------------|---|----------|

LISTING
CONTINUED
OVER THE
PAGE

Mitsubishi Triton

ML L200
2006 to 2009



Product Description

Part No.

**Qty
Req**

**Retail
ea Inc GST**

Please check vehicle date range (if shown) next to product description prior to ordering

SUSPENSION KIT - Specify Front Coil Springs When Ordering

| | | |
|------------------------|-------------------|-----------|
| Light - Nitro Gas | MITSO41AKG | \$1999.00 |
| Light - Foam Cell | MITSO41AKF | \$2201.00 |
| Medium - Nitro Gas | MITSO41BKG | \$1999.00 |
| Medium - Foam Cell | MITSO41BKF | \$2201.00 |
| Medium - Foam Cell Pro | MITSO41BKP | \$3678.00 |
| Heavy - Nitro Gas | MITSO41CKG | \$2056.00 |
| Heavy - Foam Cell | MITSO41CKF | \$2259.00 |
| Heavy - Foam Cell Pro | MITSO41CKP | \$3735.00 |

• Unladen manual vehicles with 2 piece tail shaft may experience vibration in first gear

SUSPENSION KIT CONTENTS

| | | | |
|-----------------------|--------------|--|----------------------------|
| Shock Absorbers | Leaf Springs | U-Bolts | Polyurethane Spring Bushes |
| Strut Shock Absorbers | Coil Springs | Upper Control Arms (Foam Cell Pro Kits Only) | |



MK L200
1996 to 2006

Mitsubishi Triton

Product Description

Part No.

Qty Req

Retail ea Inc GST

Please check vehicle date range (if shown) next to product description prior to ordering

SUSPENSION TO SUIT MITSUBISHI TRITON MK - 1996-2006

FRONT SUSPENSION

SHOCK ABSORBER

| | | | |
|-------------------------|----------------|---|----------|
| Nitro Gas - Performance | 12087GR | 2 | \$160.00 |
| Foam Cell - Performance | 24087FE | 2 | \$232.00 |

TORSION BAR

| | | | |
|----------------------|-----------------|---|----------|
| Uprated Torsion Bars | MITSO15C | 1 | \$435.00 |
|----------------------|-----------------|---|----------|

• Minimum 60mm downward suspension travel required after adjustment

STEERING DAMPER

| | | | | |
|-----------|-----------------------------------|-------------|---|----------|
| Foam Cell | Suits vehicles w/o power steering | 3517 | 1 | \$175.00 |
|-----------|-----------------------------------|-------------|---|----------|

REAR SUSPENSION

SHOCK ABSORBER

| | | | |
|--------------------------|-----------------|---|----------|
| Nitro Gas - Comfort | 12698GRC | 2 | \$160.00 |
| Nitro Gas - Performance | 12698GR | 2 | \$160.00 |
| Nitro Gas - Professional | 12698GRP | 2 | \$160.00 |
| Foam Cell - Comfort | 24698FEC | 2 | \$232.00 |
| Foam Cell - Performance | 24698FE | 2 | \$232.00 |
| Foam Cell - Professional | 24698FEP | 2 | \$232.00 |

LEAF SPRINGS

| | Est. Lift | Additional Load | | | |
|--------|-----------|-----------------|-----------------|---|----------|
| Medium | 40mm | 0 - 300kg | MITSO18B | 2 | \$392.00 |
| Heavy | 40mm | 300kg - GVM | MITSO18C | 2 | \$421.00 |

• Must use Ironman 4x4 bushes

U-BOLTS

| | | | |
|------------|---------------|---|---------|
| U-Bolt Kit | 451UBK | 2 | \$44.00 |
|------------|---------------|---|---------|

POLYURETHANE SPRING BUSHES

| | | | |
|----------|---------------|---|---------|
| Bush Kit | 715TUK | 1 | \$88.00 |
|----------|---------------|---|---------|

• Not compatible with OEM springs

GREASABLE SHACKLES AND PINS

| | | | |
|-------------------|--------------|---|---------|
| Greasable Shackle | 795 | 2 | \$59.00 |
| Non-Greasable Pin | 387-1 | 2 | \$30.00 |

HELPER SPRINGS

| | | | |
|--------------------------|------------|---|----------|
| Load Plus Helper Springs | LP4 | 1 | \$165.00 |
|--------------------------|------------|---|----------|

SUSPENSION KIT

| | | |
|--------------------|--------------------|-----------|
| Medium - Nitro Gas | MITSO15BKG1 | \$2028.00 |
| Medium - Foam Cell | MITSO15BKF1 | \$2317.00 |
| Heavy - Nitro Gas | MITSO15CKG1 | \$2085.00 |
| Heavy - Foam Cell | MITSO15CKF1 | \$2375.00 |

SUSPENSION KIT CONTENTS

| | | | |
|-----------------|--------------|----------------------------|-----------------------|
| Shock Absorbers | Coil Springs | Polyurethane Spring Bushes | Strut Shock Absorbers |
| Leaf Springs | U-Bolts | Brake Hose Relocation Kit | |

Mitsubishi Triton

ME-MJ
1993 to 1996



Product Description

Part No.

Qty
Req

Retail
ea Inc GST

Please check vehicle date range (if shown) next to product description prior to ordering

SUSPENSION TO SUIT MITSUBISHI TRITON ME-MJ - 1993-1996

FRONT SUSPENSION

SHOCK ABSORBER

| | | | |
|-------------------------|----------------|---|----------|
| Nitro Gas - Performance | 12082GR | 2 | \$160.00 |
| Foam Cell - Performance | 24082FE | 2 | \$232.00 |

TORSION BAR

| | | | |
|----------------------|-----------------|---|----------|
| Uprated Torsion Bars | MITS015C | 1 | \$435.00 |
|----------------------|-----------------|---|----------|

• Minimum 60mm downward suspension travel required after adjustment

STEERING DAMPER

| | | | | |
|-----------|-----------------------------------|-------------|---|----------|
| Foam Cell | Suits vehicles w/o power steering | 3517 | 1 | \$175.00 |
|-----------|-----------------------------------|-------------|---|----------|

REAR SUSPENSION

SHOCK ABSORBER

| | | | |
|--------------------------|-----------------|---|----------|
| Nitro Gas - Comfort | 12636GRC | 2 | \$160.00 |
| Nitro Gas - Performance | 12636GR | 2 | \$160.00 |
| Nitro Gas - Professional | 12636GRP | 2 | \$160.00 |
| Foam Cell - Comfort | 24636FEC | 2 | \$232.00 |
| Foam Cell - Performance | 24636FE | 2 | \$232.00 |
| Foam Cell - Professional | 24636FEP | 2 | \$232.00 |

LEAF SPRINGS

| | Est. Lift | Additional Load | | | |
|--------|-----------|-----------------|-----------------|---|----------|
| Medium | 40mm | 0 - 300kg | MITS018B | 2 | \$392.00 |
| Heavy | 40mm | 300kg - GVM | MITS018C | 2 | \$421.00 |

• Must use Ironman 4x4 bushes

U-BOLTS

| | | | |
|------------|---------------|---|---------|
| U-Bolt Kit | 451UBK | 2 | \$44.00 |
|------------|---------------|---|---------|

POLYURETHANE SPRING BUSHES

| | | | |
|----------|---------------|---|---------|
| Bush Kit | 715TUK | 1 | \$88.00 |
|----------|---------------|---|---------|

• Not compatible with OEM springs

GREASABLE SHACKLES AND PINS

| | | | |
|-------------------|--------------|---|---------|
| Greasable Shackle | 795 | 2 | \$59.00 |
| Non-Greasable Pin | 387-1 | 2 | \$30.00 |

HELPER SPRINGS

| | | | |
|--------------------------|------------|---|----------|
| Load Plus Helper Springs | LP4 | 1 | \$165.00 |
|--------------------------|------------|---|----------|

SUSPENSION KIT

| | | |
|--------------------|-------------------|-----------|
| Medium - Nitro Gas | MITS015BKG | \$2028.00 |
| Medium - Foam Cell | MITS015BKF | \$2317.00 |
| Heavy - Nitro Gas | MITS015CKG | \$2085.00 |
| Heavy - Foam Cell | MITS015CKF | \$2375.00 |

SUSPENSION KIT CONTENTS

| | | |
|-----------------|--------------|----------------------------|
| Shock Absorbers | Torsion Bars | Polyurethane Spring Bushes |
| Leaf Springs | U-Bolts | |



L200
Pre 1993

Mitsubishi Triton

Product Description

Part No.

Qty
ReqRetail
ea Inc GST

Please check vehicle date range (if shown) next to product description prior to ordering

SUSPENSION TO SUIT MITSUBISHI TRITON L200 - PRE 1993

FRONT SUSPENSION

SHOCK ABSORBER

| | | | |
|-------------------------|----------------|---|----------|
| Nitro Gas - Performance | 12082GR | 2 | \$160.00 |
| Foam Cell - Performance | 24082FE | 2 | \$232.00 |

TORSION BAR

| | | | |
|----------------------|----------------|---|----------|
| Uprated Torsion Bars | MITSO13 | 1 | \$435.00 |
|----------------------|----------------|---|----------|

• Minimum 60mm downward suspension travel required after adjustment

STEERING DAMPER

| | | | | |
|-----------|-----------------------------------|-------------|---|----------|
| Foam Cell | Suits vehicles w/o power steering | 3517 | 1 | \$175.00 |
|-----------|-----------------------------------|-------------|---|----------|

REAR SUSPENSION

SHOCK ABSORBER

| | | | |
|--------------------------|-----------------|---|----------|
| Nitro Gas - Comfort | 12636GRC | 2 | \$160.00 |
| Nitro Gas - Performance | 12636GR | 2 | \$160.00 |
| Nitro Gas - Professional | 12636GRP | 2 | \$160.00 |
| Foam Cell - Comfort | 24636FEC | 2 | \$232.00 |
| Foam Cell - Performance | 24636FE | 2 | \$232.00 |
| Foam Cell - Professional | 24636FEP | 2 | \$232.00 |

LEAF SPRINGS

| | Est. Lift | Additional Load | | | |
|--------|-----------|-----------------|-----------------|---|----------|
| Medium | 45mm | 0 - 300kg | MITSO18B | 2 | \$392.00 |
| Heavy | 45mm | 300kg - GVM | MITSO18C | 2 | \$421.00 |

• Must use Ironman 4x4 bushes

U-BOLTS

| | | | |
|------------|---------------|---|---------|
| U-Bolt Kit | 451UBK | 2 | \$44.00 |
|------------|---------------|---|---------|

POLYURETHANE SPRING BUSHES

| | | | |
|----------|--------------|---|---------|
| Bush Kit | 715UK | 1 | \$88.00 |
|----------|--------------|---|---------|

GREASABLE SHACKLES AND PINS

| | | | |
|-------------------|------------|---|---------|
| Greasable Shackle | 795 | 2 | \$59.00 |
| Greasable Pin | 796 | 2 | \$30.00 |

HELPER SPRINGS

| | | | |
|--------------------------|------------|---|----------|
| Load Plus Helper Springs | LP4 | 1 | \$165.00 |
|--------------------------|------------|---|----------|

SUSPENSION KIT

| | | |
|--------------------|--------------------|-----------|
| Medium - Nitro Gas | MITSO18BKG1 | \$2028.00 |
| Medium - Foam Cell | MITSO18BKF1 | \$2317.00 |
| Heavy - Nitro Gas | MITSO18CKG1 | \$2085.00 |
| Heavy - Foam Cell | MITSO18CKF1 | \$2375.00 |

SUSPENSION KIT CONTENTS

| | | |
|-----------------|--------------|----------------------------|
| Shock Absorbers | Torsion Bars | Polyurethane Spring Bushes |
| Leaf Springs | U-Bolts | |

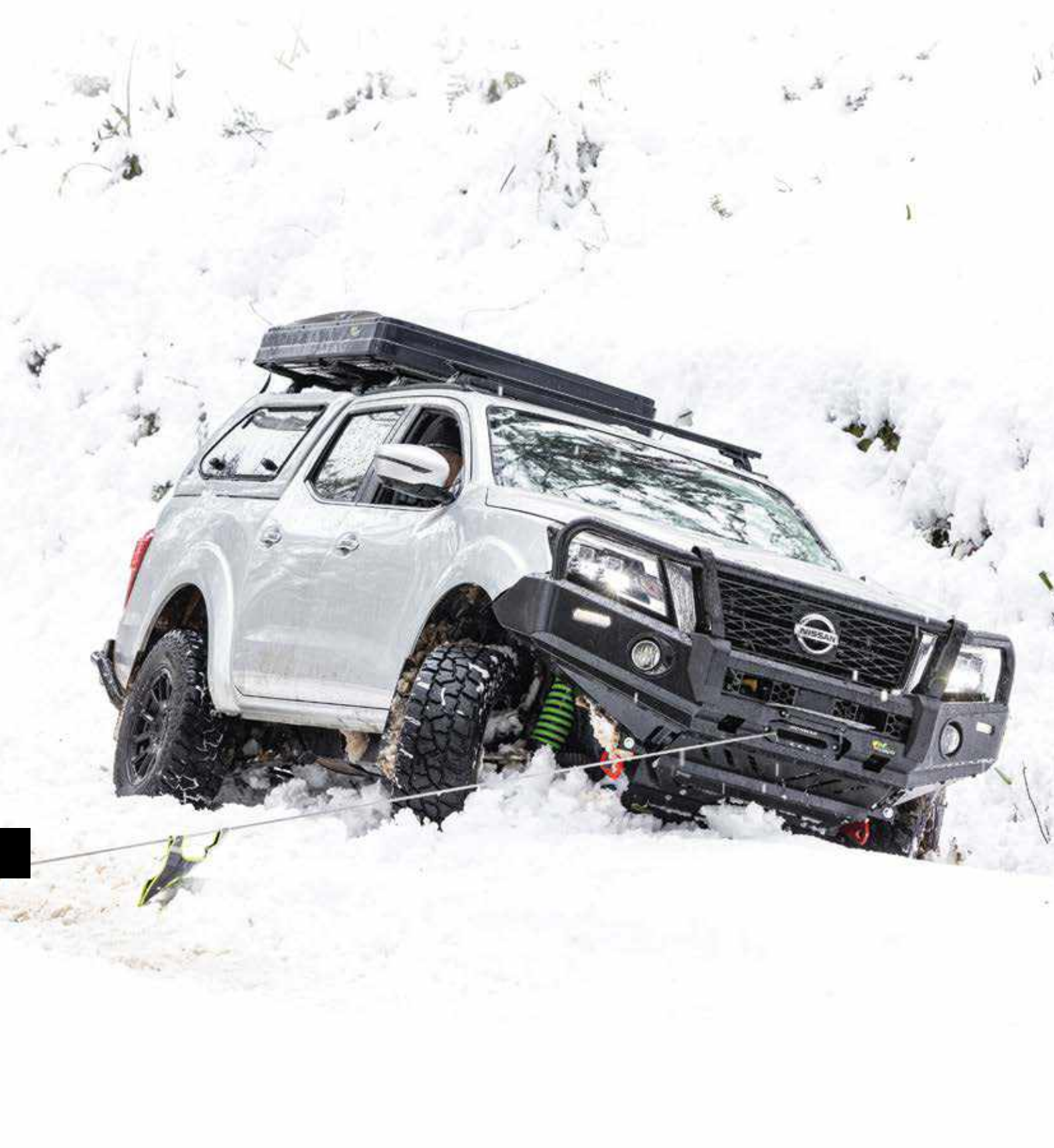

Be ready for every occasion!



Nissan Navara

NP300
2021+ Series 5

Product Description

DATE AVAILABLE

Part No.

Qty
ReqRetail
ea Inc GST*Please check vehicle date range (if shown) next to product description prior to ordering*

ACCESSORIES TO SUIT NISSAN NAVARA NP300 - 2021+

STEEL WINCH BULL BARS

| | | | |
|---|--|------------------|-----------|
| Commercial Deluxe ^Δ | | BBCD082 | \$2345.00 |
| Premium - 60.3mm Tube† | | BBP082 | \$2523.00 |
| Proguard No Loop | | BBT082-NL | \$1939.00 |
| Bull Bar Multi-Function Light Patch Loom | | IBBPLO82 | \$173.00 |
| Driving Light / Lightbar Patch Loom | | IPL048 | \$33.00 |
| * Nissan Australia recommend installation of heavy duty front coil springs when installing a bull bar - Aust Only | | NISS040C | \$262.00 |

† Low profile design retains ADAS radar in factory grille

^Δ Relocates ADAS radar into bull bar

• Premium bull bar compatible with Ironman 4x4 Lightbar, refer below for available option

LIGHTING OPTION - TO SUIT PREMIUM BULL BAR

| | | | |
|---|--|-------------------|----------|
| 75W Bright Sabre Single Row Lightbar 524mm (20") Straight | | ILBSR003BW | \$198.00 |
|---|--|-------------------|----------|

STEEL SIDE STEPS AND RAILS - FITS DUAL CAB MODELS ONLY

| | | | |
|--|----------------|--------------------|-----------|
| Side Steps | Q1 2023 | SS048-D | \$962.00 |
| Side Rails | Q1 2023 | SS048 RAIL | \$317.00 |
| Side Steps and Rails | Q1 2023 | SSR048-D | \$1155.00 |
| Premium Side Steps - 60.3mm Tube | | SSP082 | \$1103.00 |
| Premium Side Rails - 60.3mm Tube | | SSP082 RAIL | \$402.00 |
| Premium Side Steps and Rails - 60.3mm Tube | | SSRP082 | \$1334.00 |

SSR082-D and SS082 RAIL suit BBCD082 Bull bar. SSRP082 and SSP082 RAIL suit BBP082 bull bar

TOWING

| | | | |
|---|--|----------------|-----------|
| Rear Protection Towbar - Full Rear Bumper Replacement | | RTB082 | \$1388.00 |
| Towbar Wiring Loom - Plug and Play | | ITBL082 | \$466.00 |

RECOVERY POINTS - IRONMAN 4X4 BULL BAR ONLY

| | | | |
|--|--|---------------|----------|
| Recovery Points - 5000kg Rating (Pair) | | IRP005 | \$227.00 |
|--|--|---------------|----------|

LOCKSAFE DRAWER SYSTEMS - FITS DUAL AND EXTRA CAB

| | | | |
|------------------------|--|----------------|-----------|
| Twin Drawers - 1300mm | | ITD1300 | \$1536.00 |
| Single Drawer - 1300mm | | ISD1300 | \$932.00 |
| Wing Kit - 1300mm* | | ITDW048 | \$367.00 |

*Designed to suit factory tubs, will not suit ute liner without modification.

SNORKEL

| | | | |
|--|--|--------------------|----------|
| Suits wide and narrow body 2.3L twin and single turbo diesel | | ISNORKEL048 | \$437.00 |
|--|--|--------------------|----------|

PREMIUM UNDERBODY PROTECTION

| | | | |
|--|--|----------------|----------|
| Engine Bay and Transmission - Series 5 | | UBP048S | \$782.00 |
|--|--|----------------|----------|

CANOPY - PINNACLE 2 FIBREGLASS (SIDE LIFT UP WINDOWS AND CENTRAL LOCKING REAR DOOR) - FITS 4X4 AND 4X2 DUAL CAB MODELS

| | | | |
|------------------------|--|----------------------|-----------|
| Pre-Primed | | ICANOPY082-P | \$3213.00 |
| Black Star (G42) | | ICANOPY082-B | \$3763.00 |
| Brilliant Silver (K23) | | ICANOPY082-BS | \$3763.00 |
| Stealth Grey (KBY) | | ICANOPY082-SG | \$3763.00 |
| Solid White (QM1) | | ICANOPY082-SW | \$3763.00 |
| Twilight Grey (K21) | | ICANOPY082-TG | \$3763.00 |
| White Pearl (QX1) | | ICANOPY082-WP | \$3763.00 |

* Pre-primed canopies, plus colour coding.

SLIDE-AWAY ROLL UP HARD TONNEAU COVER

| | | | |
|------------------------------|--|------------------------|-----------|
| Electric with Remote Control | | ISLIDEAWAY082-E | \$2716.00 |
|------------------------------|--|------------------------|-----------|

ATLAS DUAL CAB ROOF RACK KITS

| | | | |
|--|--|----------------------|-----------|
| Platform B with Blade Fit Kit (Dual Cab Only) - 1530mm Length* | | IFR048PBK | \$1816.00 |
| Crossbar (x 2) and Fit Kit (Dual Cab) - 1250mm Width* | | IFR048C2K | \$616.00 |
| Platform K with Leg Fit Kit to Suit Pinnacle 2 Canopy - 1390mm Length | | IFRP2PKK | \$1294.00 |
| Crossbar (x 2) and Fit Kit to Suit Pinnacle 2 Canopy - 1250mm Width | | IFRP2C125K | \$564.00 |
| Platform S with Blade Fit Kit to Suit Slideaway Hard Tonneau Cover - 1390mm Length | | IFRSLDAWAYPSK | \$1670.00 |
| Crossbar (x 2) and Fit Kit to Suit Slideaway Hard Tonneau Cover - 1500mm Width | | IFRSLDAWAYC2K | \$940.00 |

*Does not suit models with OE raised rails.

• See Page 36 and 37 for more Atlas rack and crossbar options.

FENDER FLARE KITS

| | | | |
|---|--|----------------|----------|
| Matte Black Smooth Finish 6" (Suits Dual Cab) | | IFF6082 | \$499.00 |
|---|--|----------------|----------|

SEAT COVER

| | | | |
|------------------------|--|-----------------|----------|
| Canvas Comfort - Front | | ICSC082F | \$420.00 |
| Canvas Comfort - Rear | | ICSC082R | \$420.00 |

BREATHER KIT

| | | | |
|---|--|-----------------|----------|
| Universal Twin Manifold Filtered Breather Kit | | IDIFFBRE | \$115.00 |
|---|--|-----------------|----------|

LISTING
CONTINUED
OVER THE
PAGE

SUSPENSION TO SUIT Nissan Navara / Renault Alaskan

NP300 (Coil Springs)
2015 to 2020 Series 1 to 4
Alaskan 2017+
2021+ Series 5



Product Description

Part No.

Qty
Req

Retail
ea Inc GST

Please check vehicle date range (if shown) next to product description prior to ordering

SUSPENSION TO SUIT NISSAN NAVARA NP300 / RENAULT ALASKAN - 2015+

FRONT SUSPENSION

SHOCK ABSORBER

| | | | | | |
|---|--|--|-------------------|---|----------|
| Nitro Gas Strut - Performance | | | 12716GR | 2 | \$232.00 |
| Foam Cell Strut - Performance | | | 24716FE | 2 | \$262.00 |
| Foam Cell Pro Strut - Performance | | | 45716FE | 2 | \$406.00 |
| Foam Cell Pro Strut - Performance - Long Travel* (SEE NOTE) | | | 45716LFE * | 2 | \$406.00 |

*NOTE: MANDATORY FITMENT of Ironman 4x4 UCA048FA is required with Long Travel - Foam Cell Pro

• Foam Cell Pro contains a single adjusting ring for driveshaft clearance

COIL SPRINGS

| | Est. Lift | Additional Load | | | |
|----------|-----------|-----------------|-----------------|---|----------|
| Standard | 0mm | 0 - 50kg | NISS040A | 1 | \$262.00 |
| Light | 20mm | 0 - 50kg | NISS040B | 1 | \$262.00 |
| Medium | 35mm | 0 - 80kg | NISS040C | 1 | \$262.00 |
| Heavy | 40mm | 50 - 110kg | NISS040D | 1 | \$262.00 |

• Series 5 vehicles are produced with a 25mm increased ride height from factory. The resulting lift estimated with Ironman 4x4 suspension will be 25mm less than stated above

STRUT MOUNTS

| | | | | | |
|-----------------|--|--|----------------|---|---------|
| Steel Strut Top | | | ISST007 | 2 | \$88.00 |
|-----------------|--|--|----------------|---|---------|

TRIM PACKERS

| | | | | | |
|------------------------|-----------------------|--|-------------------------|---|---------|
| 5mm Strut Trim Packer | Nitro Gas / Foam Cell | | HILFR05/HILFR05F | 2 | \$30.00 |
| 10mm Strut Trim Packer | Nitro Gas / Foam Cell | | HILFR10/HILFR10F | 2 | \$30.00 |
| 15mm Strut Trim Packer | Nitro Gas / Foam Cell | | HILFR15/HILFR15F | 2 | \$30.00 |

• ONLY Compatible with Ironman 4x4 Struts (except Pro), lift height subject to 2:1 motion ratio. Unnecessary fitment may lift vehicle too high

CONTROL ARMS

| | | | | | |
|------------------------------|--|--|-----------------|---|----------|
| Pro-Forge Upper Control Arms | | | UCA048FA | 1 | \$882.00 |
|------------------------------|--|--|-----------------|---|----------|

REAR SUSPENSION

SHOCK ABSORBER

| | | | | | |
|------------------------------|--|--|-----------------|---|----------|
| Nitro Gas - Performance | | | 12728GR | 2 | \$160.00 |
| Foam Cell - Performance | | | 24728FE | 2 | \$232.00 |
| Foam Cell - Professional | | | 24728FEP | 2 | \$232.00 |
| Foam Cell Pro - Comfort | | | 45728FEC | 2 | \$319.00 |
| Foam Cell Pro - Performance | | | 45728FE | 2 | \$319.00 |
| Foam Cell Pro - Professional | | | 45728FEP | 2 | \$319.00 |

• When fitting Foam Cell Pro shock absorbers to the rear of the vehicle, a small modification may be needed on some vehicles to create clearance between the shock body and the lower shock mount gusset on the differential. Also note the Foam Cell Pro lower eye is offset to assist with clearance.

COIL SPRINGS

| | Est. Lift | Additional Load | | | |
|-------------|-----------|-----------------|-----------------|---|----------|
| Light | 20mm | 0 - 200kg | NISS058A | 1 | \$262.00 |
| Medium | 40mm | 0 - 300kg | NISS058B | 1 | \$262.00 |
| Heavy | 40mm | 300kg - 600kg | NISS058C | 1 | \$262.00 |
| Extra Heavy | 45mm | 600kg - GVM | NISS058D | 1 | \$262.00 |

• Series 5 vehicles are produced with a 25mm increased ride height from factory. The resulting lift estimated with Ironman 4x4 suspension will be 25mm less than stated above

COIL SPACER

| | | | | | |
|-------------------|--|--|---------------|---|---------|
| Polyurethane 20mm | | | NAVR20 | 2 | \$44.00 |
|-------------------|--|--|---------------|---|---------|

SPACER KIT

| | | | | | |
|--|--|--|--------------|---|----------|
| Sway Bar and Headlight Bracket Extension Kit | | | 1204K | 1 | \$102.00 |
|--|--|--|--------------|---|----------|

SUSPENSION KIT - Specify Front Coil Springs When Ordering

| | | |
|-----------------------------|-------------------|-----------|
| Medium - Nitro Gas | NISS058BKG | \$1405.00 |
| Medium - Foam Cell | NISS058BKF | \$1608.00 |
| Medium - Foam Cell Pro | NISS058BKP | \$2071.00 |
| Heavy - Nitro Gas | NISS058CKG | \$1405.00 |
| Heavy - Foam Cell | NISS058CKF | \$1608.00 |
| Heavy - Foam Cell Pro | NISS058CKP | \$2071.00 |
| Extra Heavy - Nitro Gas | NISS058DKG | \$1405.00 |
| Extra Heavy - Foam Cell | NISS058DKF | \$1608.00 |
| Extra Heavy - Foam Cell Pro | NISS058DKP | \$2071.00 |

• Specify front Coil Springs when ordering

• Series 5 vehicles are produced with a 25mm increased ride height from factory. The resulting lift estimated with Ironman 4x4 suspension will be 25mm less than stated above

SUSPENSION KIT CONTENTS

| | |
|-----------------|------------------------------------|
| Shock Absorbers | Strut Shock Absorbers |
| Coil Springs | Sway Bar and Headlight Bracket Kit |



Nissan Navara

NP300 (Leaf Springs)
2015 to 2020 Series 1 to 4
2021+ Series 5



Product Description

Part No.

Qty
ReqRetail
ea Inc GST

Please check vehicle date range (if shown) next to product description prior to ordering

SUSPENSION TO SUIT NISSAN NAVARA NP300 - 2015+

FRONT SUSPENSION

SHOCK ABSORBER

| | | | | | |
|---|--|--|-------------------|---|----------|
| Nitro Gas Strut - Performance | | | 12716GR | 2 | \$232.00 |
| Foam Cell Strut - Performance | | | 24716FE | 2 | \$262.00 |
| Foam Cell Pro Strut - Performance | | | 45716FE | 2 | \$406.00 |
| Foam Cell Pro Strut - Performance - Long Travel* (SEE NOTE) | | | 45716LFE * | 2 | \$406.00 |

*NOTE: MANDATORY FITMENT of Ironman 4x4 UCA048FA is required with Long Travel - Foam Cell Pro

• Foam Cell Pro contains a single adjusting ring for driveshaft clearance

COIL SPRINGS

| | Est. Lift | Additional Load | | | |
|----------|-----------|-----------------|-----------------|---|----------|
| Standard | 0mm | 0 - 50kg | NISS040A | 1 | \$262.00 |
| Light | 20mm | 0 - 50kg | NISS040B | 1 | \$262.00 |
| Medium | 35mm | 0 - 80kg | NISS040C | 1 | \$262.00 |
| Heavy | 40mm | 50 - 110kg | NISS040D | 1 | \$262.00 |

STRUT MOUNTS

| | | | | | |
|-----------------|--|--|----------------|---|---------|
| Steel Strut Top | | | ISST007 | 2 | \$88.00 |
|-----------------|--|--|----------------|---|---------|

TRIM PACKERS

| | | | | |
|------------------------|-----------------------|-------------------------|---|---------|
| 5mm Strut Trim Packer | Nitro Gas / Foam Cell | HILFR05/HILFR05F | 2 | \$30.00 |
| 10mm Strut Trim Packer | Nitro Gas / Foam Cell | HILFR10/HILFR10F | 2 | \$30.00 |
| 15mm Strut Trim Packer | Nitro Gas / Foam Cell | HILFR15/HILFR15F | 2 | \$30.00 |

• ONLY Compatible with Ironman 4x4 Struts (Except Pro), lift height subject to 2:1 motion ratio. Unnecessary fitment may lift vehicle too high

CONTROL ARMS

| | | | | | |
|------------------------------|--|--|-----------------|---|----------|
| Pro-Forge Upper Control Arms | | | UCA048FA | 1 | \$882.00 |
|------------------------------|--|--|-----------------|---|----------|

REAR SUSPENSION

SHOCK ABSORBER

| | | | | | |
|------------------------------|--|--|-----------------|---|----------|
| Nitro Gas - Comfort | | | 12698GRC | 2 | \$160.00 |
| Nitro Gas - Performance | | | 12698GR | 2 | \$160.00 |
| Foam Cell - Comfort | | | 24698FEC | 2 | \$232.00 |
| Foam Cell - Performance | | | 24698FE | 2 | \$232.00 |
| Foam Cell - Professional | | | 24698FEP | 2 | \$232.00 |
| Foam Cell Pro - Comfort | | | 45698FEC | 2 | \$319.00 |
| Foam Cell Pro - Performance | | | 45698FE | 2 | \$319.00 |
| Foam Cell Pro - Professional | | | 45698FEP | 2 | \$319.00 |

LEAF SPRINGS

| | Est. Lift | Additional Load | | | |
|--------|-----------|-----------------|-----------------|---|----------|
| Medium | 40mm | 0 - 300kg | NISS057B | 2 | \$392.00 |
| Heavy | 40mm | 300kg - GVM | NISS057C | 2 | \$421.00 |

U-BOLTS

| | | | | | |
|------------|--|--|----------------|---|---------|
| U-Bolt Kit | | | 1104UBK | 2 | \$44.00 |
|------------|--|--|----------------|---|---------|

POLYURETHANE SPRING BUSHES

| | | | | | |
|----------|--|--|---------------|---|---------|
| Bush Kit | | | 704TUK | 1 | \$88.00 |
|----------|--|--|---------------|---|---------|

GREASABLE SHACKLES AND PINS

| | | | | | |
|-------------------|--|--|--------------|---|---------|
| Greasable Shackle | | | 797-3 | 2 | \$59.00 |
|-------------------|--|--|--------------|---|---------|

HELPER SPRINGS

| | | | | | |
|--------------------------|--|--|----------------|---|----------|
| Load Plus Helper Springs | | | LP2 | 1 | \$165.00 |
| Add-A-Leaf | | | ISL6010 | 1 | \$175.00 |

SUSPENSION KIT - Specify Front Coil Springs When Ordering

| | | |
|------------------------|-------------------|-----------|
| Medium - Nitro Gas | NISS057BKG | \$1999.00 |
| Medium - Foam Cell | NISS057BKF | \$2201.00 |
| Medium - Foam Cell Pro | NISS057BKP | \$2664.00 |
| Heavy - Nitro Gas | NISS057CKG | \$2056.00 |
| Heavy - Foam Cell | NISS057CKF | \$2259.00 |
| Heavy - Foam Cell Pro | NISS057CKP | \$2723.00 |

SUSPENSION KIT CONTENTS

Shock Absorbers

Coil Springs

Polyurethane Spring Bushes

Leaf Springs

U-Bolts



Product Description

Part No.

Qty
ReqRetail
ea Inc GST

Please check vehicle date range (if shown) next to product description prior to ordering

ACCESSORIES TO SUIT NISSAN NAVARA NP300 - 2015-2020

STEEL WINCH BULL BARS - THAI BUILT MODEL ONLY (SUITS WIDE BODY)

| | | |
|--|-----------|-----------|
| Commercial | BBC048 | \$1723.00 |
| Commercial Deluxe | BBCD048 | \$2345.00 |
| Polished Alloy | BBA048 | \$2472.00 |
| Proguard No Loop | BBT048-NL | \$1939.00 |
| Proguard Single Loop Kit | BB048-SL | \$352.00 |
| Proguard Triple Loop Kit | BB048-TL | \$423.00 |
| Driving Light / Lightbar Patch Loom - Factory LED Headlight models only | IPL048 | \$33.00 |
| <i>* Nissan Australia recommend installation of heavy duty front coil springs when installing a bull bar - Aust Only</i> | NISS040C | \$262.00 |

STEEL SIDE STEPS AND RAILS - FITS DUAL CAB MODELS ONLY

| | | |
|----------------------|------------|-----------|
| Side Steps | SS048 | \$1006.00 |
| Side Rails | SS048 RAIL | \$332.00 |
| Side Steps and Rails | SSR048 | \$1207.00 |

TOWING

| | | |
|---|-------------|-----------|
| Class 4 Towbar - Compatible with Factory Rear Bumper | TB048 | \$608.00 |
| Rear Protection Towbar - Full Rear Bumper Replacement | RTB048 | \$1388.00 |
| Rear Protection Towbar Plates (Pair) | RTBPLATE048 | \$153.00 |
| Towbar Wiring Loom - Plug and Play | ITBL048 | \$289.00 |

RECOVERY POINTS - IRONMAN 4X4 BULL BAR ONLY

| | | |
|--|--------|----------|
| Recovery Points - 5000kg Rating (Pair) | IRP005 | \$227.00 |
|--|--------|----------|

LOCKSAFE DRAWER SYSTEMS - FITS DUAL AND EXTRA CAB

| | | |
|------------------------|---------|-----------|
| Twin Drawers - 1300mm | ITD1300 | \$1536.00 |
| Single Drawer - 1300mm | ISD1300 | \$932.00 |
| Wing Kit - 1300mm* | ITDW048 | \$367.00 |

**Designed to suit factory tubs, will not suit ute liner without modification.*

SNORKEL

| | | |
|--|-------------|----------|
| Suits wide and narrow body 2.3L twin and single turbo diesel | ISNORKEL048 | \$437.00 |
|--|-------------|----------|

LONG RANGE FUEL TANK

| | | |
|--|---------|-----------|
| 140L* - Auto/Coil Spring Diesel only. Not compatible with AdBlue equipped models | TANK048 | \$1180.00 |
|--|---------|-----------|

** Usable volume may differ to the stated tank capacity*

PREMIUM UNDERBODY PROTECTION

| | | |
|---|---------|----------|
| Engine Bay and Transmission - Series 1 | UBP048 | \$782.00 |
| Engine Bay and Transmission - Series 2, 3 and 4 | UBP048S | \$782.00 |

Nissan Navara

NP300
2015 to 2020 Series 1 to 4

| Product Description | Part No. | Qty Req | Retail ea Inc GST |
|---|-------------------|------------|----------------------|
| Please check vehicle date range (if shown) next to product description prior to ordering | | | |
| CANOPY - ABS PLASTIC (SIDE LIFT UP WINDOWS AND CENTRAL LOCKING REAR DOOR) - FITS 4X4 AND 4X2 DUAL CAB MODELS | | | |
| White (QM1) | CANOPY013-PW | | \$3856.00 |
| Cosmic Black (G42) | CANOPY013-CB | | \$3856.00 |
| ABS Canopy Rack Feet | IRRFETABS14 | | \$287.00 |
| • See Page 38 for 1.4m Roof Rack options and pricing. | | | |
| CANOPY - PINNACLE SMOOTH FINISH FIBREGLASS (SIDE LIFT UP WINDOWS AND CENTRAL LOCKING REAR DOOR) - FITS 4X4 AND 4X2 DUAL CAB MODELS | | | |
| White (QM1) | CANFIBRE048-PW | | \$3763.00 |
| Brilliant Silver (K23) | CANFIBRE048-BS | | \$3763.00 |
| White Diamond (QX1) | CANFIBRE048-WP | | \$3763.00 |
| Slate Grey (K21) | CANFIBRE048-SG | | \$3763.00 |
| * Pre-primed canopies, plus colour coding. | | | |
| SLIDE-AWAY ROLL UP HARD TONNEAU COVER | | | |
| Electric with Remote Control | ISLIDEAWAY048-E | | \$2716.00 |
| Sports Bar Adaptor | ISLIDEAWAY048-SBA | | \$135.00 |
| ATLAS DUAL CAB ROOF RACK KITS | | | |
| Platform B with Blade Fit Kit (Dual Cab Only) - 1530mm Length | IFR048PBK | | \$1816.00 |
| Crossbar (x 2) and Fit Kit (Dual Cab) - 1250mm Width | IFR048C2K | | \$616.00 |
| Platform K with Leg Fit Kit to Suit Pinnacle 2 Canopy - 1390mm Length | IFRP2PKK | | \$1294.00 |
| Crossbar (x 2) and Fit Kit to Suit Pinnacle 2 Canopy - 1250mm Width | IFRP2C125K | | \$564.00 |
| Platform S with Blade Fit Kit to Suit Slideaway Hard Tonneau Cover - 1390mm Length | IFRSLDAWAYPSK | | \$1670.00 |
| Crossbar (x 2) and Fit Kit to Suit Slideaway Hard Tonneau Cover - 1500mm Width | IFRSLDAWAYC2K | | \$940.00 |
| * Does not suit models with OE raised rails. | | | |
| • See Page 36 and 37 for more Atlas rack and crossbar options. | | | |
| FENDER FLARE KITS | | | |
| Matte Black Smooth Finish 6" (Suits Dual Cab) | IFF6048 | | \$499.00 |
| SEAT COVER | | | |
| Canvas Comfort - Front | ICSC048F | | \$420.00 |
| Canvas Comfort - Rear (Does not suit series 3) | ICSC048R | | \$420.00 |
| Canvas Comfort - Rear (Suits series 3) | ICSC048MYR | | \$420.00 |
| BREATHER KIT | | | |
| Universal Twin Manifold Filtered Breather Kit | IDIFFBRE | | \$115.00 |



Urban Assault



D40
2005+

Nissan Navara

| Product Description | Part No. | Qty Req | Retail ea Inc GST |
|---|-------------|------------|----------------------|
| ACCESSORIES TO SUIT NISSAN NAVARA D40 - 2005+ | | | |
| STEEL WINCH BULL BARS - RECESSED LINE IN OE BUMPER BAR AND THAI BUILT VEHICLES WITH SMOOTH BUMPER | | | |
| Commercial Deluxe | BBCD012 | | \$2345.00 |
| • Can also be fitted to both 2WD and 4WD models. | | | |
| STEEL WINCH BULL BARS - SMOOTH OE BUMPER BAR EXCEPT THAI BUILT VEHICLES | | | |
| Commercial Deluxe | BBCD042 | | \$2345.00 |
| • Can also be fitted to both 2WD and 4WD models. | | | |
| • STX Spain Built 2010+ - Fits 440(4Cyl) and 550 (V6) Smooth Bumper | | | |
| STEEL SIDE STEPS AND RAILS - THAI BUILT DUAL CAB MODEL | | | |
| Side Steps | SS007 | | \$1006.00 |
| Side Steps and Rails | SSR003 | | \$1207.00 |
| STEEL SIDE STEPS AND RAILS - SPAIN BUILT 2010+ DUAL CAB MODEL | | | |
| Side Steps | SS042 | | \$1006.00 |
| Side Steps and Rails | SSR042 | | \$1207.00 |
| RECOVERY POINTS - IRONMAN 4X4 BULL BAR ONLY | | | |
| Recovery Points - 5000kg Rating (Pair) | IRP005 | | \$227.00 |
| LOCKSAFE DRAWER SYSTEMS | | | |
| Twin Drawers - 1300mm | ITD1300 | | \$1536.00 |
| Single Drawer - 1300mm | ISD1300 | | \$932.00 |
| Wing Kit - 1300mm (ST 2010+)* | ITDW028 | | \$367.00 |
| Wing Kit - 1300mm (STX, 2006+ Spain built)* | ITDW029 | | \$367.00 |
| *Designed to suit factory tubs, will not suit ute liner without modification. | | | |
| SNORKEL | | | |
| D40 Navara 2005+ - Not including RX models | ISNORKEL019 | | \$437.00 |
| • Not compatible with RX models. | | | |
| LONG RANGE FUEL TANK | | | |
| Spain Built 145L* Dual Cab - Diesel only | TANK003 | | \$1180.00 |
| Thai Built 145L* Dual Cab - Diesel only (includes adaptor kit) | TANK003T | | \$1180.00 |
| * Usable volume may differ to the stated tank capacity | | | |
| UNDERBODY PROTECTION | | | |
| Engine Bay, Radiator* and Transmission - <i>While Stocks Last</i> | IUP007K | | \$563.00 |
| * IMPORTANT - Radiator plate ONLY suitable for Spain Built Vehicle. Does not fit vehicles with bull bar fitted. | | | |
| SEAT COVER | | | |
| Canvas Comfort - Front | ICSC042F | | \$420.00 |
| Canvas Comfort - Rear | ICSC042R | | \$420.00 |
| BREATHER KIT | | | |
| Universal Twin Manifold Filtered Breather Kit | IDIFFBRE | | \$115.00 |

LISTING
CONTINUED
OVER THE
PAGE

Nissan Navara

D40 (V6 Diesel)
2005+



Product Description

Part No.

Qty
Req

Retail
ea Inc GST

Please check vehicle date range (if shown) next to product description prior to ordering

SUSPENSION TO SUIT NISSAN NAVARA D40 - 2005+

FRONT SUSPENSION

SHOCK ABSORBER

| | | | | | |
|---|--|--|-------------------|---|----------|
| Nitro Gas Strut - Performance | | | 12716GR | 2 | \$232.00 |
| Foam Cell Strut - Performance | | | 24716FE | 2 | \$262.00 |
| Foam Cell Pro Strut - Performance | | | 45716FE | 2 | \$406.00 |
| Foam Cell Pro Strut - Performance - Long Travel* (SEE NOTE) | | | 45716LFE * | 2 | \$406.00 |

*NOTE: MANDATORY FITMENT of Ironman 4x4 UCA048FA is required with Long Travel - Foam Cell Pro

• Foam Cell Pro contains a single adjusting ring for driveshaft clearance

COIL SPRINGS

| | Est. Lift | Additional Load | | | |
|--------|-----------|-----------------|-----------------|---|----------|
| Medium | 35mm | 0 - 50kg | NISS040C | 1 | \$262.00 |
| Heavy | 35mm | 50 - 110kg | NISS040D | 1 | \$262.00 |

STRUT MOUNTS

| | | | | | |
|-----------------|--|--|----------------|---|---------|
| Steel Strut Top | | | ISST007 | 2 | \$88.00 |
|-----------------|--|--|----------------|---|---------|

TRIM PACKERS

| | | | | |
|------------------------|-----------------------|-------------------------|---|---------|
| 5mm Strut Trim Packer | Nitro Gas / Foam Cell | HILFR05/HILFR05F | 2 | \$30.00 |
| 10mm Strut Trim Packer | Nitro Gas / Foam Cell | HILFR10/HILFR10F | 2 | \$30.00 |
| 15mm Strut Trim Packer | Nitro Gas / Foam Cell | HILFR15/HILFR15F | 2 | \$30.00 |

• ONLY Compatible with Ironman 4x4 Struts (Except Pro), lift height subject to 2:1 motion ratio. Unnecessary fitment may lift vehicle too high

CONTROL ARMS

| | | | | | |
|------------------------------|--|--|-----------------|---|----------|
| Pro-Forge Upper Control Arms | | | UCA048FA | 1 | \$882.00 |
|------------------------------|--|--|-----------------|---|----------|

REAR SUSPENSION

SHOCK ABSORBER

| | | | | | |
|------------------------------|--|--|-----------------|---|----------|
| Nitro Gas - Performance | | | 12717GR | 2 | \$160.00 |
| Foam Cell - Performance | | | 24717FE | 2 | \$232.00 |
| Foam Cell - Professional | | | 24717FEP | 2 | \$232.00 |
| Foam Cell Pro - Performance | | | 45717FE | 2 | \$319.00 |
| Foam Cell Pro - Professional | | | 45717FEP | 2 | \$319.00 |

LEAF SPRINGS

| | Est. Lift | Additional Load | | | |
|-------------|-----------|-----------------|-----------------|---|----------|
| Medium | 40mm | 0 - 300kg | NISS041B | 2 | \$392.00 |
| Heavy | 40mm | 300 - 500kg | NISS041C | 2 | \$421.00 |
| Extra Heavy | 40mm | 500kg - GVM | NISS041D | 2 | \$421.00 |

U-BOLTS

| | | | | |
|-----------------------|-----------------------------|----------------|---|---------|
| U-Bolt Kit | Suits NISS041B and NISS041C | 437UBK | 2 | \$44.00 |
| U-Bolt Kit Extra Long | Suits NISS041D | 437UBKL | 2 | \$44.00 |

POLYURETHANE SPRING BUSHES

| | | | | |
|----------|--|--------------|---|---------|
| Bush Kit | | 769UK | 1 | \$88.00 |
|----------|--|--------------|---|---------|

GREASABLE SHACKLES AND PINS

| | | | | |
|-------------------|--|--------------|---|---------|
| Greasable Shackle | | 797-1 | 2 | \$59.00 |
|-------------------|--|--------------|---|---------|

AXLE PROTECTION

| | | | | |
|--------------------------|--|---------------|---|----------|
| ABS Wire and Axle Shield | | IAP001 | 1 | \$102.00 |
|--------------------------|--|---------------|---|----------|

HELPER SPRINGS

| | | | | |
|--------------------------|--|----------------|---|----------|
| Load Plus Helper Springs | | LP2 | 1 | \$165.00 |
| Add-A-Leaf | | ISL6010 | 1 | \$175.00 |

SUSPENSION KIT - Specify Front Coil Springs When Ordering

| | | |
|-----------------------------|--------------------|-----------|
| Medium - Nitro Gas | NISS041BKG1 | \$1999.00 |
| Medium - Foam Cell | NISS041BKF1 | \$2201.00 |
| Medium - Foam Cell Pro | NISS041BKP1 | \$2664.00 |
| Heavy - Nitro Gas | NISS041CKG1 | \$2056.00 |
| Heavy - Foam Cell | NISS041CKF1 | \$2259.00 |
| Heavy - Foam Cell Pro | NISS041CKP1 | \$2723.00 |
| Extra Heavy - Nitro Gas | NISS041DKG1 | \$2056.00 |
| Extra Heavy - Foam Cell | NISS041DKF1 | \$2259.00 |
| Extra Heavy - Foam Cell Pro | NISS041DKP1 | \$2723.00 |

SUSPENSION KIT CONTENTS

| | | |
|-----------------|--------------|----------------------------|
| Shock Absorbers | Coil Springs | Polyurethane Spring Bushes |
| Leaf Springs | U-Bolts | Strut Shock Absorbers |





D40 (4cyl Diesel and V6 Petrol)
2005+

Nissan Navara

Product Description

Part No.

Qty Req

Retail ea Inc GST

Please check vehicle date range (if shown) next to product description prior to ordering

SUSPENSION TO SUIT NISSAN NAVARA D40 - 2005+

FRONT SUSPENSION

SHOCK ABSORBER

| | | | | | |
|---|--|--|-------------------|---|----------|
| Nitro Gas Strut - Performance | | | 12716GR | 2 | \$232.00 |
| Foam Cell Strut - Performance | | | 24716FE | 2 | \$262.00 |
| Foam Cell Pro Strut - Performance | | | 45716FE | 2 | \$406.00 |
| Foam Cell Pro Strut - Performance - Long Travel* (SEE NOTE) | | | 45716LFE * | 2 | \$406.00 |

*NOTE: MANDATORY FITMENT of Ironman 4x4 UCA048FA is required with Long Travel - Foam Cell Pro

• Foam Cell Pro contains a single adjusting ring for driveshaft clearance

COIL SPRINGS

| | Est. Lift | Additional Load | | | |
|--------|-----------|-----------------|-----------------|---|----------|
| Medium | 35mm | 0 - 50kg | NISS040B | 1 | \$262.00 |
| Heavy | 35mm | 50 - 110kg | NISS040C | 1 | \$262.00 |

STRUT MOUNTS

| | | | | | |
|-----------------|--|--|----------------|---|---------|
| Steel Strut Top | | | ISST007 | 2 | \$88.00 |
|-----------------|--|--|----------------|---|---------|

TRIM PACKERS

| | | | | |
|------------------------|-----------------------|-------------------------|---|---------|
| 5mm Strut Trim Packer | Nitro Gas / Foam Cell | HILFR05/HILFR05F | 2 | \$30.00 |
| 10mm Strut Trim Packer | Nitro Gas / Foam Cell | HILFR10/HILFR10F | 2 | \$30.00 |
| 15mm Strut Trim Packer | Nitro Gas / Foam Cell | HILFR15/HILFR15F | 2 | \$30.00 |

• ONLY Compatible with Ironman 4x4 Struts (Except Pro), lift height subject to 2:1 motion ratio. Unnecessary fitment may lift vehicle too high

CONTROL ARMS

| | | | | | |
|------------------------------|--|--|-----------------|---|----------|
| Pro-Forge Upper Control Arms | | | UCA048FA | 1 | \$882.00 |
|------------------------------|--|--|-----------------|---|----------|

REAR SUSPENSION

SHOCK ABSORBER

| | | | | | |
|------------------------------|--|--|-----------------|---|----------|
| Nitro Gas - Performance | | | 12717GR | 2 | \$160.00 |
| Foam Cell - Performance | | | 24717FE | 2 | \$232.00 |
| Foam Cell - Professional | | | 24717FEP | 2 | \$232.00 |
| Foam Cell Pro - Performance | | | 45717FE | 2 | \$319.00 |
| Foam Cell Pro - Professional | | | 45717FEP | 2 | \$319.00 |

LEAF SPRINGS

| | Est. Lift | Additional Load | | | |
|-------------|-----------|-----------------|-----------------|---|----------|
| Medium | 40mm | 0 - 300kg | NISS041B | 2 | \$392.00 |
| Heavy | 40mm | 300 - 500kg | NISS041C | 2 | \$421.00 |
| Extra Heavy | 40mm | 500kg - GVM | NISS041D | 2 | \$421.00 |

U-BOLTS

| | | | | |
|-----------------------|-----------------------------|----------------|---|---------|
| U-Bolt Kit | Suits NISS041B and NISS041C | 437UBK | 2 | \$44.00 |
| U-Bolt Kit Extra Long | Suits NISS041D | 437UBKL | 2 | \$44.00 |

POLYURETHANE SPRING BUSHES

| | | | | |
|----------|--|--------------|---|---------|
| Bush Kit | | 769UK | 1 | \$88.00 |
|----------|--|--------------|---|---------|

GREASABLE SHACKLES AND PINS

| | | | | |
|-------------------|--|--------------|---|---------|
| Greasable Shackle | | 797-1 | 2 | \$59.00 |
|-------------------|--|--------------|---|---------|

AXLE PROTECTION

| | | | | |
|--------------------------|--|---------------|---|----------|
| ABS Wire and Axle Shield | | IAP001 | 1 | \$102.00 |
|--------------------------|--|---------------|---|----------|

HELPER SPRINGS

| | | | | |
|--------------------------|--|----------------|---|----------|
| Load Plus Helper Springs | | LP2 | 1 | \$165.00 |
| Add-A-Leaf | | ISL6010 | 1 | \$175.00 |

SUSPENSION KIT - Specify Front Coil Springs When Ordering

| | | |
|-----------------------------|-------------------|-----------|
| Medium - Nitro Gas | NISS041BKG | \$1886.00 |
| Medium - Foam Cell | NISS041BKF | \$2201.00 |
| Medium - Foam Cell Pro | NISS041BKP | \$2664.00 |
| Heavy - Nitro Gas | NISS041CKG | \$2056.00 |
| Heavy - Foam Cell | NISS041CKF | \$2259.00 |
| Heavy - Foam Cell Pro | NISS041CKP | \$2723.00 |
| Extra Heavy - Nitro Gas | NISS041DKG | \$2056.00 |
| Extra Heavy - Foam Cell | NISS041DKF | \$2259.00 |
| Extra Heavy - Foam Cell Pro | NISS041DKP | \$2723.00 |

SUSPENSION KIT CONTENTS

| | | |
|-----------------|--------------|----------------------------|
| Shock Absorbers | Coil Springs | Polyurethane Spring Bushes |
| Leaf Springs | U-Bolts | Strut Shock Absorbers |

Nissan Navara

D22
2002+



Product Description

Part No.

Qty
Req

Retail
ea Inc GST

Please check vehicle date range (if shown) next to product description prior to ordering

ACCESSORIES TO SUIT NISSAN NAVARA D22 - 2002+

STEEL WINCH BULL BARS

Commercial Deluxe

BBCD013

\$2345.00

• Can also be fitted to both 2WD and 4WD models.

LOCKSAFE DRAWER SYSTEMS

Twin Drawer - 1300mm

ITD1300

\$1536.00

Single Drawer - 1300mm

ISD1300

\$932.00

Wing Kit - 1300mm (2002 to 2007)*

ITDW025

\$367.00

Wing Kit - 1300mm (2007+)*

ITDW026

\$367.00

**Designed to suit factory tubs, will not suit ute liner without modification.*

BREATHER KIT

Universal Twin Manifold Filtered Breather Kit

IDIFFBRE

\$115.00





D22 / NP300 (Torsion Bar)
1997+

Nissan Navara

Product Description

Part No.

Qty
Req

Retail
ea Inc GST

Please check vehicle date range (if shown) next to product description prior to ordering

SUSPENSION TO SUIT NISSAN NAVARA D22 - 1997+

FRONT SUSPENSION

SHOCK ABSORBER

| | | | | |
|-------------------------|--|----------------|---|----------|
| Nitro Gas - Performance | | 12791GR | 2 | \$160.00 |
|-------------------------|--|----------------|---|----------|

• Upper control arm may contact shock absorber, grind away material on control arm for clearance

TORSION BAR

| | | | | |
|----------------------|--|----------------|---|----------|
| Uprated Torsion Bars | | NISS025 | 1 | \$435.00 |
|----------------------|--|----------------|---|----------|

• Minimum 60mm downward suspension travel required after adjustment

REAR SUSPENSION

SHOCK ABSORBER

| | | | | |
|--------------------------|--|-----------------|---|----------|
| Nitro Gas - Comfort | | 12636GRC | 2 | \$160.00 |
| Nitro Gas - Performance | | 12636GR | 2 | \$160.00 |
| Nitro Gas - Professional | | 12636GRP | 2 | \$160.00 |

LEAF SPRINGS EST. LIFT ADDITIONAL LOAD

| | | | | | |
|-----------------------|------|-------------|--------------------|---|----------|
| Light - Drivers Side | 40mm | 0 - 100kg | NISS014AD/S | 1 | \$392.00 |
| Light - Near Side | 40mm | 0 - 100kg | NISS014AN/S | 1 | \$392.00 |
| Medium - Drivers Side | 40mm | 0 - 250kg | NISS014BD/S | 1 | \$392.00 |
| Medium - Near Side | 40mm | 0 - 250kg | NISS014BN/S | 1 | \$392.00 |
| Heavy - Drivers Side | 40mm | 250kg - GVM | NISS014CD/S | 1 | \$421.00 |
| Heavy - Near Side | 40mm | 250kg - GVM | NISS014CN/S | 1 | \$421.00 |

U-BOLTS

| | | | | |
|------------|--|---------------|---|---------|
| U-Bolt Kit | | 788UBK | 2 | \$44.00 |
|------------|--|---------------|---|---------|

POLYURETHANE SPRING BUSHES

| | | | | |
|----------|--|--------------|---|---------|
| Bush Kit | | 704UK | 1 | \$88.00 |
|----------|--|--------------|---|---------|

GREASABLE SHACKLES AND PINS

| | | | | |
|-------------------|--|------------|---|---------|
| Greasable Shackle | | 797 | 2 | \$74.00 |
| Greasable Pin | | 798 | 2 | \$30.00 |

HELPER SPRINGS

| | | | | |
|--------------------------|--|----------------|---|----------|
| Load Plus Helper Springs | | LP3 | 1 | \$165.00 |
| Add-A-Leaf | | ISL6010 | 1 | \$175.00 |

SUSPENSION KIT

| | | | | |
|--------------------|--|-------------------|--|-----------|
| Light - Nitro Gas | | NISS025AKG | | \$2028.00 |
| Medium - Nitro Gas | | NISS025BKG | | \$2028.00 |
| Heavy - Nitro Gas | | NISS025CKG | | \$2085.00 |

SUSPENSION KIT CONTENTS

| | | |
|-----------------|--------------|----------------------------|
| Shock Absorbers | Torsion Bars | Polyurethane Spring Bushes |
| Leaf Springs | U-Bolts | |



Nissan Navara

D21
1985 to 1996



Product Description

Part No.

Qty
Req

Retail
ea Inc GST

Please check vehicle date range (if shown) next to product description prior to ordering

SUSPENSION TO SUIT NISSAN NAVARA D21 - 1985-1996

FRONT SUSPENSION

SHOCK ABSORBER

| | | | |
|-------------------------|----------------|---|----------|
| Nitro Gas - Performance | 12087GR | 2 | \$160.00 |
| Foam Cell - Performance | 24087FE | 2 | \$232.00 |

TORSION BAR

| | | | |
|-----------------------|----------------|---|----------|
| Up-rated Torsion Bars | NISS013 | 1 | \$435.00 |
|-----------------------|----------------|---|----------|

• Minimum 60mm downward suspension travel required after adjustment

REAR SUSPENSION

SHOCK ABSORBER

| | | | |
|--------------------------|-----------------|---|----------|
| Nitro Gas - Comfort | 12636GRC | 2 | \$160.00 |
| Nitro Gas - Performance | 12636GR | 2 | \$160.00 |
| Nitro Gas - Professional | 12636GRP | 2 | \$160.00 |
| Foam Cell - Comfort | 24636FEC | 2 | \$232.00 |
| Foam Cell - Performance | 24636FE | 2 | \$232.00 |
| Foam Cell - Professional | 24636FEP | 2 | \$232.00 |

LEAF SPRINGS EST. LIFT ADDITIONAL LOAD

| | | | | | |
|-----------------------|------|-------------|--------------------|---|----------|
| Light - Drivers Side | 40mm | 0 - 100kg | NISS014AD/S | 1 | \$392.00 |
| Light - Near Side | 40mm | 0 - 100kg | NISS014AN/S | 1 | \$392.00 |
| Medium - Drivers Side | 40mm | 0 - 250kg | NISS014BD/S | 1 | \$392.00 |
| Medium - Near Side | 40mm | 0 - 250kg | NISS014BN/S | 1 | \$392.00 |
| Heavy - Drivers Side | 40mm | 250kg - GVM | NISS014CD/S | 1 | \$421.00 |
| Heavy - Near Side | 40mm | 250kg - GVM | NISS014CN/S | 1 | \$421.00 |

U-BOLTS

| | | | |
|------------|---------------|---|---------|
| U-Bolt Kit | 788UBK | 2 | \$44.00 |
|------------|---------------|---|---------|

POLYURETHANE SPRING BUSHES

| | | | |
|----------|--------------|---|---------|
| Bush Kit | 704UK | 1 | \$88.00 |
|----------|--------------|---|---------|

GREASABLE SHACKLES AND PINS

| | | | |
|-------------------|------------|---|---------|
| Greasable Shackle | 797 | 2 | \$74.00 |
| Greasable Pin | 798 | 2 | \$30.00 |

HELPER SPRINGS

| | | | |
|--------------------------|----------------|---|----------|
| Load Plus Helper Springs | LP3 | 1 | \$165.00 |
| Add-A-Leaf | ISL6010 | 1 | \$175.00 |

SUSPENSION KIT

| | | |
|--------------------|-------------------|-----------|
| Light - Nitro Gas | NISS014AKG | \$2028.00 |
| Light - Foam Cell | NISS014AKF | \$2317.00 |
| Medium - Nitro Gas | NISS014BKG | \$2028.00 |
| Medium - Foam Cell | NISS014BKF | \$2317.00 |
| Heavy - Nitro Gas | NISS014CKG | \$2056.00 |
| Heavy - Foam Cell | NISS014CKF | \$2347.00 |

SUSPENSION KIT CONTENTS

| | | |
|-----------------|--------------|----------------------------|
| Shock Absorbers | Torsion Bars | Polyurethane Spring Bushes |
| Leaf Springs | U-Bolts | |



Pre 2005

Nissan Paladin

Product Description

Part No.

Qty
ReqRetail
ea Inc GST

Please check vehicle date range (if shown) next to product description prior to ordering

SUSPENSION TO SUIT NISSAN PALADIN - PRE 2005

FRONT SUSPENSION

SHOCK ABSORBER

| | | | |
|-------------------------|---------|---|----------|
| Nitro Gas - Performance | 12791GR | 2 | \$160.00 |
|-------------------------|---------|---|----------|

TORSION BAR

| | | | |
|----------------------|---------|---|----------|
| Uprated Torsion Bars | NISS048 | 1 | \$435.00 |
|----------------------|---------|---|----------|

• Minimum 60mm downward suspension travel required after adjustment

REAR SUSPENSION

SHOCK ABSORBER

| | | | |
|---------------------|----------|---|----------|
| Nitro Gas - Comfort | 12698GRC | 2 | \$160.00 |
|---------------------|----------|---|----------|

| | | | |
|-------------------------|---------|---|----------|
| Nitro Gas - Performance | 12698GR | 2 | \$160.00 |
|-------------------------|---------|---|----------|

| | | | |
|---------------------|----------|---|----------|
| Foam Cell - Comfort | 24698FEC | 2 | \$232.00 |
|---------------------|----------|---|----------|

| | | | |
|-------------------------|---------|---|----------|
| Foam Cell - Performance | 24698FE | 2 | \$232.00 |
|-------------------------|---------|---|----------|

| | | | |
|--------------------------|----------|---|----------|
| Foam Cell - Professional | 24698FEP | 2 | \$232.00 |
|--------------------------|----------|---|----------|

LEAF SPRINGS EST. LIFT ADDITIONAL LOAD

| | | | | | |
|--------|------|-----------|----------|---|----------|
| Medium | 40mm | 0 - 250kg | NISS049B | 2 | \$392.00 |
|--------|------|-----------|----------|---|----------|

U-BOLTS

| | | | |
|------------|--------|---|---------|
| U-Bolt Kit | 654UBK | 2 | \$44.00 |
|------------|--------|---|---------|

POLYURETHANE SPRING BUSHES

| | | | |
|----------|--------|---|---------|
| Bush Kit | 769UKL | 1 | \$88.00 |
|----------|--------|---|---------|

GREASABLE SHACKLES AND PINS

| | | | |
|-------------------|-------|---|---------|
| Greasable Shackle | 797-2 | 2 | \$59.00 |
|-------------------|-------|---|---------|

| | | | |
|---------------|-----|---|---------|
| Greasable Pin | 798 | 2 | \$30.00 |
|---------------|-----|---|---------|

HELPER SPRINGS

| | | | |
|--------------------------|-----|---|----------|
| Load Plus Helper Springs | LP2 | 1 | \$165.00 |
|--------------------------|-----|---|----------|

| | | | |
|------------|---------|---|----------|
| Add-A-Leaf | ISL6010 | 1 | \$175.00 |
|------------|---------|---|----------|

SUSPENSION KIT

| | | |
|--------------------|------------|-----------|
| Medium - Nitro Gas | NISS049BKG | \$2144.00 |
|--------------------|------------|-----------|

SUSPENSION KIT CONTENTS

Shock Absorbers

Shackles

Polyurethane Spring Bushes

Leaf Springs

U-Bolts

Nissan Pathfinder

R51
2005 to 2013



Product Description

Part No.

Qty
Req

Retail
ea Inc GST

Please check vehicle date range (if shown) next to product description prior to ordering

ACCESSORIES TO SUIT NISSAN PATHFINDER R51 - 2005-2013

STEEL WINCH BULL BARS - RECESSED LINE IN OE BUMPER BAR AND THAI VEHICLES WITH SMOOTH BUMPER

| | | |
|-------------------|----------------|-----------|
| Commercial Deluxe | BBCD012 | \$2345.00 |
|-------------------|----------------|-----------|

STEEL WINCH BULL BARS - SMOOTH OE BUMPER BAR EXCEPT THAI BUILT VEHICLES

| | | |
|-------------------|----------------|-----------|
| Commercial Deluxe | BBCD042 | \$2345.00 |
|-------------------|----------------|-----------|

• STX Spain Built 2010+ - Fits 2012 V6 model only

SNORKEL

| | | |
|----------------|--------------------|----------|
| R51 Pathfinder | ISNORKELO19 | \$437.00 |
|----------------|--------------------|----------|

BREATHER KIT

| | | |
|---|-----------------|----------|
| Universal Twin Manifold Filtered Breather Kit | IDIFFBRE | \$115.00 |
|---|-----------------|----------|



R51 (V6 Diesel)
7/2005+

Nissan Pathfinder

Product Description

Part No.

Qty
ReqRetail
ea Inc GST

Please check vehicle date range (if shown) next to product description prior to ordering

SUSPENSION TO SUIT NISSAN PATHFINDER R51 - 7/2005+

FRONT SUSPENSION

SHOCK ABSORBER

| | | | | | |
|--|--|--|-------------------|---|----------|
| Nitro Gas Strut - Performance | | | 12716GR | 2 | \$232.00 |
| Foam Cell Strut - Performance | | | 24716FE | 2 | \$262.00 |
| Foam Cell Pro Strut - Performance | | | 45716FE | 2 | \$406.00 |
| Foam Cell Pro Strut - Performance - Long Travel* (SEE NOTE) | | | 45716LFE * | 2 | \$406.00 |

*NOTE: MANDATORY FITMENT of Ironman 4x4 UCA048FA is required with Long Travel - Foam Cell Pro

• Foam Cell Pro contains a single adjusting ring for driveshaft clearance

COIL SPRINGS

| | Est. Lift | Additional Load | | | |
|--------|-----------|-----------------|-----------------|---|----------|
| Medium | 35mm | 0 - 50kg | NISS040C | 1 | \$262.00 |
| Heavy | 35mm | 50 - 110kg | NISS040D | 1 | \$262.00 |

STRUT MOUNTS

| | | | | | |
|-----------------|--|--|----------------|---|---------|
| Steel Strut Top | | | ISST007 | 2 | \$88.00 |
|-----------------|--|--|----------------|---|---------|

TRIM PACKERS

| | | | | |
|------------------------|-----------------------|-------------------------|---|---------|
| 5mm Strut Trim Packer | Nitro Gas / Foam Cell | HILFR05/HILFR05F | 2 | \$30.00 |
| 10mm Strut Trim Packer | Nitro Gas / Foam Cell | HILFR10/HILFR10F | 2 | \$30.00 |
| 15mm Strut Trim Packer | Nitro Gas / Foam Cell | HILFR15/HILFR15F | 2 | \$30.00 |

• ONLY Compatible with Ironman 4x4 Struts (Except Pro), lift height subject to 2:1 motion ratio. Unnecessary fitment may lift vehicle too high

CONTROL ARMS

| | | | | | |
|------------------------------|--|--|-----------------|---|----------|
| Pro-Forge Upper Control Arms | | | UCA048FA | 1 | \$882.00 |
|------------------------------|--|--|-----------------|---|----------|

REAR SUSPENSION

SHOCK ABSORBER

| | | | | | |
|-------------------------|--|--|----------------|---|----------|
| Nitro Gas - Performance | | | 12718GR | 2 | \$160.00 |
| Foam Cell - Performance | | | 24718FE | 2 | \$232.00 |

COIL SPRINGS

| | Est. Lift | Additional Load | | | |
|--------|-----------|-----------------|-----------------|---|----------|
| Medium | 40mm | 0 - 250kg | NISS042B | 1 | \$262.00 |
| Heavy | 40mm | 250kg - GVM | NISS042C | 1 | \$262.00 |

SUSPENSION KIT - Specify Front Coil Springs When Ordering

| | | |
|--------------------|--------------------|-----------|
| Medium - Nitro Gas | NISS042BKG1 | \$1304.00 |
| Medium - Foam Cell | NISS042BKF1 | \$1506.00 |
| Heavy - Nitro Gas | NISS042CKG1 | \$1304.00 |
| Heavy - Foam Cell | NISS042CKF1 | \$1506.00 |

SUSPENSION KIT CONTENTS

Shock Absorbers

Strut Shock Absorbers

Coil Springs



Outback Tested





R51 (4cyl Diesel and V6 Petrol)
7/2005+

Nissan Pathfinder

Product Description

Part No.

Qty
ReqRetail
ea Inc GST

Please check vehicle date range (if shown) next to product description prior to ordering

SUSPENSION TO SUIT NISSAN PATHFINDER R51 - 7/2005+

FRONT SUSPENSION

SHOCK ABSORBER

| | | | | | |
|--|--|--|-------------------|---|----------|
| Nitro Gas Strut - Performance | | | 12716GR | 2 | \$232.00 |
| Foam Cell Strut - Performance | | | 24716FE | 2 | \$262.00 |
| Foam Cell Pro Strut - Performance | | | 45716FE | 2 | \$406.00 |
| Foam Cell Pro Strut - Performance - Long Travel* (SEE NOTE) | | | 45716LFE * | 2 | \$406.00 |

*NOTE: MANDATORY FITMENT of Ironman 4x4 UCA048FA is required with Long Travel - Foam Cell Pro

• Foam Cell Pro contains a single adjusting ring for driveshaft clearance

COIL SPRINGS

| | Est. Lift | Additional Load | | | |
|--------|-----------|-----------------|-----------------|---|----------|
| Medium | 35mm | 0 - 50kg | NISS040B | 1 | \$262.00 |
| Heavy | 35mm | 50 - 110kg | NISS040C | 1 | \$262.00 |

STRUT MOUNTS

| | | | | | |
|-----------------|--|--|----------------|---|---------|
| Steel Strut Top | | | ISST007 | 2 | \$88.00 |
|-----------------|--|--|----------------|---|---------|

TRIM PACKERS

| | | | | |
|------------------------|-----------------------|-------------------------|---|---------|
| 5mm Strut Trim Packer | Nitro Gas / Foam Cell | HILFR05/HILFR05F | 2 | \$30.00 |
| 10mm Strut Trim Packer | Nitro Gas / Foam Cell | HILFR10/HILFR10F | 2 | \$30.00 |
| 15mm Strut Trim Packer | Nitro Gas / Foam Cell | HILFR15/HILFR15F | 2 | \$30.00 |

• ONLY Compatible with Ironman 4x4 Struts (Except Pro), lift height subject to 2:1 motion ratio. Unnecessary fitment may lift vehicle too high

CONTROL ARMS

| | | | | | |
|------------------------------|--|--|-----------------|---|----------|
| Pro-Forge Upper Control Arms | | | UCA048FA | 1 | \$882.00 |
|------------------------------|--|--|-----------------|---|----------|

REAR SUSPENSION

SHOCK ABSORBER

| | | | | | |
|-------------------------|--|--|----------------|---|----------|
| Nitro Gas - Performance | | | 12718GR | 2 | \$160.00 |
| Foam Cell - Performance | | | 24718FE | 2 | \$232.00 |

COIL SPRINGS

| | Est. Lift | Additional Load | | | |
|--------|-----------|-----------------|-----------------|---|----------|
| Medium | 40mm | 0 - 250kg | NISS042B | 1 | \$262.00 |
| Heavy | 40mm | 250kg - GVM | NISS042C | 1 | \$262.00 |

SUSPENSION KIT - Specify Front Coil Springs When Ordering

| | | |
|--------------------|-------------------|-----------|
| Medium - Nitro Gas | NISS042BKG | \$1304.00 |
| Medium - Foam Cell | NISS042BKF | \$1506.00 |
| Heavy - Nitro Gas | NISS042CKG | \$1304.00 |
| Heavy - Foam Cell | NISS042CKF | \$1506.00 |

• Mandatory 4 wheel alignment after installing new suspension

SUSPENSION KIT CONTENTS

Shock Absorbers

Strut Shock Absorbers

Coil Springs

Nissan Pathfinder

R50
1995 to 7/2005



Product Description

Part No.

Qty
Req

Retail
ea Inc GST

Please check vehicle date range (if shown) next to product description prior to ordering

SUSPENSION TO SUIT NISSAN PATHFINDER R50 - 1995-7/2005

FRONT SUSPENSION

COIL SPRINGS

| | Est. Lift | Additional Load | Part No. | Qty | Retail Price |
|--------|-----------|-----------------|-----------------|-----|--------------|
| Medium | 35mm | 0 - 50kg | NISS034B | 1 | \$262.00 |

CAMBER CORRECTION

| | | | | | |
|-----------------|--|--|------------------|---|---------|
| Camber Bolt Kit | | | ICAMBER14 | 1 | \$30.00 |
|-----------------|--|--|------------------|---|---------|

REAR SUSPENSION

COIL SPRINGS

| | Est. Lift | Additional Load | Part No. | Qty | Retail Price |
|--------|-----------|-----------------|-----------------|-----|--------------|
| Medium | 35mm | 0 - 200kg | NISS035B | 1 | \$262.00 |



R20 / WD21
Pre 1995

SUSPENSION TO SUIT Nissan Pathfinder / Terrano / II

Product Description

Part No.

Qty
Req

Retail
ea Inc GST

Please check vehicle date range (if shown) next to product description prior to ordering

SUSPENSION TO SUIT NISSAN PATHFINDER R50 / TERRANO / II - PRE 1995

FRONT SUSPENSION

SHOCK ABSORBER

| | | | |
|-------------------------|----------------|---|----------|
| Nitro Gas - Performance | 12667GR | 2 | \$160.00 |
| Foam Cell - Performance | 24667FE | 2 | \$232.00 |

TORSION BAR

| | | | |
|----------------------|----------------|---|----------|
| Uprated Torsion Bars | NISS017 | 1 | \$435.00 |
|----------------------|----------------|---|----------|

• Minimum 60mm downward suspension travel required after adjustment

REAR SUSPENSION

SHOCK ABSORBER

| | | | |
|--------------------------|-----------------|---|----------|
| Nitro Gas - Comfort | 12636GRC | 2 | \$160.00 |
| Nitro Gas - Performance | 12636GR | 2 | \$160.00 |
| Nitro Gas - Professional | 12636GRP | 2 | \$160.00 |
| Foam Cell - Comfort | 24636FEC | 2 | \$232.00 |
| Foam Cell - Performance | 24636FE | 2 | \$232.00 |
| Foam Cell - Professional | 24636FEP | 2 | \$232.00 |

COIL SPRINGS

| | Est. Lift | Additional Load | | |
|--------|-----------|-----------------|-----------------|---|
| Medium | 40mm | 0 - 250kg | NISS018B | 1 |
| Heavy | 40mm | 250kg - GVM | HOLD008B | 1 |

SUSPENSION KIT

| | | |
|--------------------|------------------|-----------|
| Medium - Nitro Gas | NISS018BK | \$1333.00 |
| Medium - Foam Cell | NISS018BK | \$1622.00 |
| Heavy - Nitro Gas | NISS018CK | \$1333.00 |
| Heavy - Foam Cell | NISS018CK | \$1622.00 |

SUSPENSION KIT CONTENTS

Shock Absorbers

Coil Springs

Torsion Bars

Nissan Patrol

Y62
2010 to 2019 Series 2 to 3
2020+ Series 5



Product Description

DATE AVAILABLE

Part No.

Qty
Req

Retail
ea Inc GST

Please check vehicle date range (if shown) next to product description prior to ordering

ACCESSORIES TO SUIT NISSAN PATROL Y62 - 2010+

STEEL WINCH BULL BARS

| | | | |
|---|----------------|---------------|-----------|
| Premium Commercial Deluxe - 60.3mm Tube - (2010 to 2019)* | | BBP062 | \$2523.00 |
| Premium Commercial Deluxe - 60.3mm Tube - (2020+) | Q1 2023 | BBP084 | \$2523.00 |
| Driving Light / Lightbar Patch Loom - Factory LED Headlight models only | | IPL084 | \$38.00 |

** Does not suit vehicles with Adaptive Cruise Control.*

STEEL SIDE STEPS AND RAILS

| | | | |
|--|----------------|--------------------|-----------|
| Premium Side Steps - 60.3mm Tube - (2020+) | Q2 2023 | SSP084 | \$1055.00 |
| Premium Side Rails - 60.3mm Tube - (2020+) | Q2 2023 | SSP084 RAIL | \$384.00 |
| Premium Side Steps and Rails - 60.3mm Tube - (2020+) | Q2 2023 | SSRP084 | \$1276.00 |

ATLAS ROOF RACK KIT

| | | | |
|---|--|-------------------|-----------|
| Platform N with Blade Fit Kit - 2130mm Length | | IFR062LPNK | \$2005.00 |
|---|--|-------------------|-----------|

• See Page 36 and 37 for more Atlas rack and crossbar options.

BREATHER KIT

| | | | |
|---|--|-----------------|----------|
| Universal Twin Manifold Filtered Breather Kit | | IDIFFBRE | \$115.00 |
|---|--|-----------------|----------|



Nissan Patrol

Y62
2010+

Product Description

Part No.

Qty
ReqRetail
ea Inc GST*Please check vehicle date range (if shown) next to product description prior to ordering***SUSPENSION TO SUIT NISSAN PATROL Y62 - 2010+****FRONT SUSPENSION****SHOCK ABSORBER**

| | | | | | |
|-----------------------------------|--|--|----------------|---|----------|
| Nitro Gas Strut - Performance | | | 12740GR | 2 | \$232.00 |
| Foam Cell Strut - Performance | | | 24740FE | 2 | \$262.00 |
| Foam Cell Pro Strut - Performance | | | 45740FE | 2 | \$406.00 |

• Non HBMC models only

COIL SPRINGS

| | Est. Lift | Additional Load | | | |
|--------|-----------|-----------------|-----------------|---|----------|
| Light | 30mm | 0 - 50kg | NISS045A | 1 | \$262.00 |
| Medium | 40mm | 0 - 50kg | NISS045B | 1 | \$262.00 |
| Heavy | 50mm | 50 - 110kg | NISS045C | 1 | \$262.00 |

TRIM PACKERS

| | | | | |
|------------------------|-----------------------|-------------------------|---|---------|
| 5mm Strut Trim Packer | Nitro Gas / Foam Cell | HILFR05/HILFR05F | 2 | \$30.00 |
| 10mm Strut Trim Packer | Nitro Gas / Foam Cell | HILFR10/HILFR10F | 2 | \$30.00 |
| 15mm Strut Trim Packer | Nitro Gas / Foam Cell | HILFR15/HILFR15F | 2 | \$30.00 |

• ONLY Compatible with Ironman 4x4 Struts (except Pro), lift height subject to 2:1 motion ratio. Unnecessary fitment may lift vehicle too high

SWAY BAR

| | | | |
|---------------|----------------|---|----------|
| 36mm Sway Bar | ISB600F | 1 | \$609.00 |
|---------------|----------------|---|----------|

REAR SUSPENSION**SHOCK ABSORBER**

| | | | | | |
|-----------------------------|--|--|----------------|---|----------|
| Nitro Gas - Performance | | | 12742GR | 2 | \$160.00 |
| Foam Cell - Performance | | | 24742FE | 2 | \$232.00 |
| Foam Cell Pro - Performance | | | 45742FE | 2 | \$319.00 |

• Non HBMC models only

COIL SPRINGS

| | Est. Lift | Additional Load | | | |
|--------|-----------|-----------------|-----------------|---|----------|
| Light | 30mm | 0 - 300kg | NISS046A | 1 | \$305.00 |
| Medium | 40mm | 0 - 300kg | NISS046B | 1 | \$305.00 |
| Heavy | 50mm | 300kg - GVM | NISS046C | 1 | \$305.00 |

SWAY BAR

| | | | |
|---------------|----------------|---|----------|
| 27mm Sway Bar | ISB600R | 1 | \$609.00 |
|---------------|----------------|---|----------|

SUSPENSION KIT - Specify Front Coil Springs When Ordering

| | | |
|------------------------|-------------------|-----------|
| Light - Nitro Gas | NISS045AKG | \$1348.00 |
| Light - Foam Cell | NISS045AKF | \$1550.00 |
| Light - Foam Cell Pro | NISS045AKP | \$2013.00 |
| Medium - Nitro Gas | NISS045BKG | \$1348.00 |
| Medium - Foam Cell | NISS045BKF | \$1550.00 |
| Medium - Foam Cell Pro | NISS045BKP | \$2013.00 |
| Heavy - Nitro Gas | NISS045CKG | \$1348.00 |
| Heavy - Foam Cell | NISS045CKF | \$1550.00 |
| Heavy - Foam Cell Pro | NISS045CKP | \$2013.00 |

• Non HBMC models only

• Mandatory 4 wheel alignment after installing new suspension

SUSPENSION KIT CONTENTS

| | |
|-----------------------|--------------|
| Shock Absorbers | Leaf Springs |
| Strut Shock Absorbers | Coil Springs |

Nissan Patrol

Y61 GU Series 4
2005+



Product Description

Part No.

Qty
Req

Retail
ea Inc GST

Please check vehicle date range (if shown) next to product description prior to ordering

ACCESSORIES TO SUIT NISSAN PATROL Y61 - 2005+

STEEL WINCH BULL BARS

Premium - 60.3mm Tube **BBP011** \$2478.00

STEEL SIDE STEPS AND RAILS

Side Steps **SS012** \$1006.00

Side Steps and Rails **SSR012** \$1207.00

Premium Side Steps and Rails - 60.3mm Tube **SSRP011** \$1334.00

RECOVERY POINTS - IRONMAN 4X4 BULL BAR ONLY

Recovery Points - 5000kg Rating (Pair) **IRP005** \$227.00

LOCKSAFE DRAWER SYSTEMS

Twin Drawers - 1000mm **ITD1000** \$1355.00

Single Drawer - 1000mm **ISD1000** \$820.00

Wing Kit - 1000mm (DX, ST, STI) **ITDW011** \$283.00

Wing Kit - 1000mm (STL, D) **ITDW012** \$283.00

SNORKEL

GU Patrol Series 4 **ISNORKEL013** \$437.00

STEEL ROOF RACKS

Cage Style - 1.4m x 1.25m **IRRCAGE14** \$812.00

Cage Style - 1.8m x 1.25m **IRRCAGE18** \$852.00

Cage Style - 2.2m x 1.25m **IRRCAGE22** \$885.00

Rooftop Tent Compatible - 1.8m x 1.25m **IRRTENT18** \$812.00

Rooftop Tent Compatible - 2.2m x 1.25m **IRRTENT22** \$852.00

Trade Style - 1.8m x 1.25m (Open end) **IRRTRADE18** \$812.00

Trade Style - 2.2m x 1.25m (Open end) **IRRTRADE22** \$846.00

ALLOY ROOF RACKS

Cage Style - 1.4m x 1.25m **IRRCAGE14-ALLOY** \$1028.00

Cage Style - 1.8m x 1.25m **IRRCAGE18-ALLOY** \$1201.00

Cage Style - 2.2m x 1.25m **IRRCAGE22-ALLOY** \$1267.00

Trade Style - 1.4m x 1.25m (Open end) **IRROPEN14-ALLOY** \$1015.00

Trade Style - 1.8m x 1.25m (Open end) **IRRTRADE18-ALLOY** \$1183.00

Trade Style - 2.2m x 1.25m (Open end) **IRRTRADE22-ALLOY** \$1235.00

Flat Rack - 1.8m x 1.25m **IRRTFLAT18-ALLOY** \$1167.00

STEEL AND ALLOY ROOF RACK - MOUNT KITS

Gutter Mount Feet - 100mm (8 Feet) **IRRFEET100** \$207.00

Gutter Mount Feet - 125mm (8 Feet) **IRRFEET125** \$207.00

SEAT COVER

Canvas Comfort - Front **ICSC011F** \$420.00

Canvas Comfort - Rear **ICSC011R** \$420.00

Canvas Comfort - Front Bucket + 3/4 Bench (GU4-GU8 Single Cab DX only) **ICSC011F3/4** \$420.00

BREATHER KIT

Universal Twin Manifold Filtered Breather Kit **IDIFFBRE** \$115.00

Nissan Patrol

Y61 GU Series 1-3
1998 to 2004

Product Description

Part No.

Qty
ReqRetail
ea Inc GST*Please check vehicle date range (if shown) next to product description prior to ordering*

ACCESSORIES TO SUIT NISSAN PATROL Y61 - 1998-2004

STEEL WINCH BULL BARS

Commercial Deluxe (Coil Spring Only)

BBCD009

\$2345.00

STEEL SIDE STEPS AND RAILS

Side Steps

SS012

\$1006.00

Side Steps and Rails

SSR012

\$1207.00

RECOVERY POINTS - IRONMAN 4X4 BULL BAR ONLY

Recovery Points - 5000kg Rating (Pair)

IRP005

\$227.00

• Series 3-5 only.

LOCKSAFE DRAWER SYSTEMS

Twin Drawers - 1000mm

ITD1000

\$1355.00

Single Drawer - 1000mm

ISD1000

\$820.00

Wing Kit - 1000mm (DX, ST, STI)*

ITDW011

\$283.00

Wing Kit - 1000mm (STL, Di)

ITDW012

\$283.00

SNORKEL

GU Patrol Series 1 2 and 3

ISNORKEL015

\$437.00

STEEL ROOF RACKS

Cage Style - 1.4m x 1.25m

IRRCAGE14

\$812.00

Cage Style - 1.8m x 1.25m

IRRCAGE18

\$852.00

Cage Style - 2.2m x 1.25m

IRRCAGE22

\$885.00

Rooftop Tent Compatible - 1.8m x 1.25m

IRRTENT18

\$812.00

Rooftop Tent Compatible - 2.2m x 1.25m

IRRTENT22

\$852.00

Trade Style - 1.8m x 1.25m (Open end)

IRRTRADE18

\$812.00

Trade Style - 2.2m x 1.25m (Open end)

IRRTRADE22

\$846.00

ALLOY ROOF RACKS

Cage Style - 1.4m x 1.25m

IRRCAGE14-ALLOY

\$1028.00

Cage Style - 1.8m x 1.25m

IRRCAGE18-ALLOY

\$1201.00

Cage Style - 2.2m x 1.25m

IRRCAGE22-ALLOY

\$1267.00

Trade Style - 1.4m x 1.25m (Open end)

IRROPEN14-ALLOY

\$1015.00

Trade Style - 1.8m x 1.25m (Open end)

IRRTRADE18-ALLOY

\$1183.00

Trade Style - 2.2m x 1.25m (Open end)

IRRTRADE22-ALLOY

\$1235.00

Flat Rack - 1.8m x 1.25m

IRRTFLAT18-ALLOY

\$1167.00

STEEL AND ALLOY ROOF RACK - MOUNT KITS

Gutter Mount Feet - 100mm (8 Feet)

IRRFEET100

\$207.00

Gutter Mount Feet - 125mm (8 Feet)

IRRFEET125

\$207.00

BREATHER KIT

Universal Twin Manifold Filtered Breather Kit

IDIFFBRE

\$115.00

LISTING
CONTINUED
OVER THE
PAGE



Product Description

Part No.

Qty
Req

Retail
ea Inc GST

Please check vehicle date range (if shown) next to product description prior to ordering

SUSPENSION TO SUIT NISSAN PATROL Y61

FRONT SUSPENSION

SHOCK ABSORBER

| | | | | | |
|------------------------------|---------------|--|------------------|---|----------|
| Nitro Gas - Performance | | | 12091GR | 2 | \$160.00 |
| Foam Cell - Performance | | | 24091FE | 2 | \$232.00 |
| Foam Cell - Professional | | | 24091FEP | 2 | \$232.00 |
| Foam Cell - Performance | Suits 4" Lift | | 24091LFE | 2 | \$262.00 |
| Foam Cell - Performance | Suits 6" Lift | | 24091LFE1 | 2 | \$291.00 |
| Foam Cell Pro - Performance | | | 45091FE | 2 | \$319.00 |
| Foam Cell Pro - Professional | | | 45091FEP | 2 | \$319.00 |
| Foam Cell Pro - Performance | Suits 4" Lift | | 45091LFE | 2 | \$334.00 |
| Foam Cell Pro - Professional | Suits 4" Lift | | 45091LFEP | 2 | \$334.00 |
| Foam Cell Pro - Performance | Suits 6" Lift | | 45091LFE1 | 2 | \$348.00 |

COIL SPRINGS

| | Est. Lift | Additional Load | | | |
|------------------|-----------|-----------------|-----------------|---|----------|
| Medium | 50mm | 0 - 50kg | NISS024B | 1 | \$262.00 |
| Medium - 4" Lift | 100mm | 0 - 100kg | NISS026B | 1 | \$406.00 |
| Medium - 6" Lift | 150mm | 0 - 100kg | NISS043B | 1 | \$479.00 |
| Heavy | 50mm | 50 - 110kg | NISS009C | 1 | \$262.00 |

STEERING DAMPER

| | | | | | |
|-----------|------------|--|-------------|---|----------|
| Foam Cell | Pre 2/2000 | | 3511 | 1 | \$175.00 |
| Foam Cell | 2/2000+ | | 3501 | 1 | \$175.00 |

CASTER CORRECTION

| | | | | | |
|-----------------------------------|------|--|------------------|---|----------|
| 2° Offset Bush Kit - Polyurethane | | | 1144SK | 1 | \$160.00 |
| 2° Offset Bush Kit - Rubber | | | 1144RK | 1 | \$160.00 |
| 5° Offset Plate Kit | | | CPLATE003 | 1 | \$232.00 |
| Radius Arm Spacer | 15mm | | 833WT | 1 | \$88.00 |
| 4° Drop Box | | | DBOX003 | 1 | \$406.00 |

STEERING RODS

| | | | | | |
|----------------------|--|--|---------------|---|----------|
| Adjustable Drag Link | | | ADL005 | 1 | \$507.00 |
| Track Rod | | | ATR005 | 1 | \$507.00 |

ADJUSTABLE PANHARD ROD

| | | | | | |
|----------------------|------------|--|-------------------|---|----------|
| Right Hand Drive Rod | Pre 2/2000 | | PANHARD003 | 1 | \$334.00 |
| Left Hand Drive Rod | Pre 2/2000 | | PANHARD008 | 1 | \$334.00 |
| Right Hand Drive Rod | 2/2000+ | | PANHARD005 | 1 | \$348.00 |
| Left Hand Drive Rod | 2/2000+ | | PANHARD009 | 1 | \$348.00 |

SWAY BAR LINK

| | | | | | |
|------------------------|-----------------|--|-----------------|---|---------|
| Extended Sway Bar Link | Suits 1-3" Lift | | SBEXT006 | 2 | \$88.00 |
| Extended Sway Bar Link | Suits 4-7" Lift | | SBEXT003 | 2 | \$88.00 |

COIL SPACER

| | | | | | |
|-------------------|--------------------|--|---------------|---|---------|
| Polyurethane 15mm | Provides 10mm Lift | | PATF15 | 2 | \$30.00 |
| Polyurethane 30mm | Provides 25mm Lift | | PATF30 | 2 | \$44.00 |

BRAKE HOSE

| | | | | | |
|---------------------|----------------|--|-----------------|---|---------|
| Extended Brake Hose | Non ABS Models | | BHOSE003 | 1 | \$74.00 |
| Extended Brake Hose | ABS models | | BHOSE005 | 2 | \$74.00 |



Y61 GU LWB Wagon

Nissan Patrol

Product Description

Part No.

Qty
ReqRetail
ea Inc GST

Please check vehicle date range (if shown) next to product description prior to ordering

REAR SUSPENSION

SHOCK ABSORBER

| | | | | | |
|------------------------------|---------------|--|------------------|---|----------|
| Nitro Gas - Performance | | | 12094GR | 2 | \$160.00 |
| Foam Cell - Performance | | | 24094FE | 2 | \$232.00 |
| Foam Cell - Professional | | | 24094FEP | 2 | \$232.00 |
| Foam Cell - Performance | Suits 4" Lift | | 24094LFE | 2 | \$262.00 |
| Foam Cell - Professional | Suits 4" Lift | | 24094LFEP | 2 | \$262.00 |
| Foam Cell - Performance | Suits 6" Lift | | 24094LFE1 | 2 | \$291.00 |
| Foam Cell Pro - Performance | | | 45094FE | 2 | \$319.00 |
| Foam Cell Pro - Professional | | | 45094FEP | 2 | \$319.00 |
| Foam Cell Pro - Performance | Suits 4" Lift | | 45094LFE | 2 | \$334.00 |
| Foam Cell Pro - Professional | Suits 4" Lift | | 45094LFEP | 2 | \$334.00 |
| Foam Cell Pro - Performance | Suits 6" Lift | | 45094LFE1 | 2 | \$348.00 |

COIL SPRINGS

| | Est. Lift | Additional Load | | | |
|------------------|-----------|-----------------|-----------------|---|----------|
| Medium | 50mm | 0 - 200kg | NISS010C | 1 | \$276.00 |
| Medium - 4" Lift | 100mm | 0 - 300kg | NISS027B | 1 | \$406.00 |
| Medium - 6" Lift | 150mm | 0 - 300kg | NISS044B | 1 | \$479.00 |
| Heavy | 50mm | 200 - 400kg | NISS020C | 1 | \$291.00 |
| Heavy - 4" Lift | 100mm | 400kg - GVM | NISS027C | 1 | \$406.00 |
| Heavy - 6" Lift | 150mm | 400kg - GVM | NISS044C | 1 | \$479.00 |
| Extra Heavy | 50mm | 400kg - GVM | NISS020D | 1 | \$435.00 |

PANHARD ROD

| | | | | | |
|------------------------|------------|--|-------------------|---|----------|
| Adjustable Panhard Rod | Pre 2/2000 | | PANHARD004 | 1 | \$334.00 |
| Adjustable Panhard Rod | 2/2000+ | | PANHARD006 | 1 | \$348.00 |

ADJUSTABLE TRAILING ARM

| | | | | | |
|--------------------|--|--|---------------|---|----------|
| Upper Trailing Arm | | | UTA003 | 2 | \$218.00 |
| Lower Trailing Arm | | | LTA003 | 2 | \$276.00 |

SWAY BAR LINK

| | | | | | |
|------------------------|-----------------|------------|-----------------|---|---------|
| Extended Sway Bar Link | Suits 1-3" Lift | Right Side | SBEXT006 | 1 | \$88.00 |
| Extended Sway Bar Link | Suits 4-7" Lift | Right Side | SBEXT003 | 1 | \$88.00 |
| Extended Sway Bar Link | Suits 1-3" Lift | Left Side | SBEXT007 | 1 | \$88.00 |
| Extended Sway Bar Link | Suits 4-7" Lift | Left Side | SBEXT004 | 1 | \$88.00 |

COIL SPACER

| | | | | | |
|-------------------|--------------------|--|---------------|---|---------|
| Polyurethane 15mm | Provides 10mm Lift | | PATR15 | 2 | \$30.00 |
| Polyurethane 30mm | Provides 25mm Lift | | PATR30 | 2 | \$44.00 |

BRAKE HOSE

| | | | | | |
|---------------------|--|--|-----------------|---|---------|
| Extended Brake Hose | | | BHOSE004 | 1 | \$74.00 |
|---------------------|--|--|-----------------|---|---------|

BRACKET KIT

| | | | | | |
|--------------------|--|--|----------------|---|----------|
| Coil Drop Out Cone | | | IDOC003 | 1 | \$262.00 |
| Coil Retainer Kit | | | ICR003 | 1 | \$131.00 |

BUSH KIT

| | | | | | |
|---|-------------------------------|--|---------------|---|----------|
| Rubber Suspension Arm Bush Kit - Pre 2/2000 | W/ Standard Radius Arm Bushes | | 839RK | 1 | \$421.00 |
| Rubber Suspension Arm Bush Kit - Pre 2/2000 | W/ Offset Radius Arm Bushes | | 839CRK | 1 | \$421.00 |
| Rubber Suspension Arm Bush Kit - 2/2000+ | W/ Standard Radius Arm Bushes | | 848RK | 1 | \$450.00 |
| Rubber Suspension Arm Bush Kit - 2/2000+ | W/ Offset Radius Arm Bushes | | 848CRK | 1 | \$450.00 |

LISTING
CONTINUED
OVER THE
PAGE

Nissan Patrol

Y61 GU LWB Wagon



Product Description

Part No.

Qty
Req

Retail
ea Inc GST

Please check vehicle date range (if shown) next to product description prior to ordering

SUSPENSION KIT - Specify Front Coil Springs When Ordering

| | | | | |
|-----------------------------|--------|------------------|---------------------|-----------|
| Medium - Nitro Gas | | | NISS024CKG | \$1174.00 |
| Medium - Foam Cell | | | NISS024CKF | \$1463.00 |
| Medium - Foam Cell | 4"Lift | RHD - Pre 2/2000 | NISS026BKF | \$4228.00 |
| Medium - Foam Cell | 4"Lift | LHD - Pre 2/2000 | NISS026BKFL | \$4228.00 |
| Medium - Foam Cell | 6"Lift | RHD - Pre 2/2000 | NISS043BKF | \$4489.00 |
| Medium - Foam Cell | 6"Lift | LHD - Pre 2/2000 | NISS043BKFL | \$4489.00 |
| Medium - Foam Cell | 4"Lift | RHD - 2/2000+ | NISS026BKF1 | \$4257.00 |
| Medium - Foam Cell | 4"Lift | LHD - 2/2000+ | NISS026BKF1L | \$4257.00 |
| Medium - Foam Cell | 6"Lift | RHD - 2/2000+ | NISS043BKF1 | \$4517.00 |
| Medium - Foam Cell | 6"Lift | LHD - 2/2000+ | NISS043BKF1L | \$4517.00 |
| Medium - Foam Cell Pro | | | NISS024CKP | \$1810.00 |
| Medium - Foam Cell Pro | 4"Lift | RHD - Pre 2/2000 | NISS026BKP | \$4517.00 |
| Medium - Foam Cell Pro | 4"Lift | LHD - Pre 2/2000 | NISS026BKPL | \$4517.00 |
| Medium - Foam Cell Pro | 6"Lift | RHD - Pre 2/2000 | NISS043BKP | \$4720.00 |
| Medium - Foam Cell Pro | 6"Lift | LHD - Pre 2/2000 | NISS043BKPL | \$4720.00 |
| Medium - Foam Cell Pro | 4"Lift | RHD - 2/2000+ | NISS026BKP1 | \$4546.00 |
| Medium - Foam Cell Pro | 4"Lift | LHD - 2/2000+ | NISS026BKP1L | \$4546.00 |
| Medium - Foam Cell Pro | 6"Lift | RHD - 2/2000+ | NISS043BKP1 | \$4749.00 |
| Medium - Foam Cell Pro | 6"Lift | LHD - 2/2000+ | NISS043BKP1L | \$4749.00 |
| Heavy - Nitro Gas | | | NISS037CKG | \$1188.00 |
| Heavy - Foam Cell | | | NISS037CKF | \$1477.00 |
| Heavy - Foam Cell | 4"Lift | RHD - Pre 2/2000 | NISS026CKF | \$4228.00 |
| Heavy - Foam Cell | 6"Lift | RHD - Pre 2/2000 | NISS043CKF | \$4489.00 |
| Heavy - Foam Cell | 4"Lift | RHD - 2/2000+ | NISS026CKF1 | \$4257.00 |
| Heavy - Foam Cell | 6"Lift | RHD - 2/2000+ | NISS043CKF1 | \$4517.00 |
| Heavy - Foam Cell Pro | | | NISS037CKP | \$1825.00 |
| Heavy - Foam Cell Pro | 4"Lift | RHD - Pre 2/2000 | NISS026CKP | \$4517.00 |
| Heavy - Foam Cell Pro | 6"Lift | RHD - Pre 2/2000 | NISS043CKP | \$4720.00 |
| Heavy - Foam Cell Pro | 4"Lift | RHD - 2/2000+ | NISS026CKP1 | \$4546.00 |
| Heavy - Foam Cell Pro | 6"Lift | RHD - 2/2000+ | NISS043CKP1 | \$4749.00 |
| Extra Heavy - Nitro Gas | | | NISS037DKG | \$1333.00 |
| Extra Heavy - Foam Cell | | | NISS037DKF | \$1530.00 |
| Extra Heavy - Foam Cell Pro | | | NISS037DKP | \$1969.00 |

- Specify ABS / non-ABS brake hoses when ordering suspension kits
 - 4" and 6" lifts may not be legal for on-road use in your area, certification may be required for on-road use
 - Due to the extreme nature of 4" and 6" lifts, further modifications may be required, and will vary between vehicles, such modifications are entirely the owners responsibility
- Ironman 4x4 accept no responsibility for any damage or injury caused by use of the these products

50MM SUSPENSION KIT CONTENTS

Shock Absorbers Coil Springs

4" AND 6" SUSPENSION KIT CONTENTS

Shock Absorbers Caster Plates
 Coil Springs Brake Hoses
 Panhard Rods Adjustable Trailing Arms
 Sway Bar Links



On the road again



Nissan Patrol

Y60 GQ / Y61 GU
Cab Chassis (Coil/Coil)



Product Description

Part No.

Qty
Req

Retail
ea Inc GST

Please check vehicle date range (if shown) next to product description prior to ordering

SUSPENSION TO SUIT NISSAN PATROL Y60 / Y61 - COIL/COIL

FRONT SUSPENSION

SHOCK ABSORBER

| | | | | | |
|------------------------------|--|---------------|------------------|---|----------|
| Nitro Gas - Performance | | | 12091GR | 2 | \$160.00 |
| Foam Cell - Performance | | | 24091FE | 2 | \$232.00 |
| Foam Cell - Professional | | | 24091FEP | 2 | \$232.00 |
| Foam Cell - Performance | | Suits 4" Lift | 24091LFE | 2 | \$262.00 |
| Foam Cell - Performance | | Suits 6" Lift | 24091LFE1 | 2 | \$291.00 |
| Foam Cell Pro - Performance | | | 45091FE | 2 | \$319.00 |
| Foam Cell Pro - Professional | | | 45091FEP | 2 | \$319.00 |
| Foam Cell Pro - Performance | | Suits 4" Lift | 45091LFE | 2 | \$334.00 |
| Foam Cell Pro - Professional | | Suits 4" Lift | 45091LFE1 | 2 | \$334.00 |
| Foam Cell Pro - Performance | | Suits 6" Lift | 45091LFE1 | 2 | \$348.00 |

COIL SPRINGS

| | Est. Lift | Additional Load | | | |
|------------------|-----------|-----------------|-----------------|---|----------|
| Medium | 50mm | 0 - 50kg | NISS024B | 1 | \$262.00 |
| Heavy | 50mm | 50 - 110kg | NISS009C | 1 | \$262.00 |
| Medium - 4" Lift | 100mm | 0 - 100kg | NISS026B | 1 | \$406.00 |
| Medium - 6" Lift | 150mm | 0 - 100kg | NISS043B | 1 | \$479.00 |

STEERING DAMPER

| | | | | | |
|-----------|--|--|-------------|---|----------|
| Foam Cell | | | 3511 | 1 | \$175.00 |
|-----------|--|--|-------------|---|----------|

CASTER CORRECTION

| | | | | | |
|-----------------------------------|--|------|------------------|---|----------|
| 2° Offset Bush Kit - Polyurethane | | | 1144SK | 1 | \$160.00 |
| 2° Offset Bush Kit - Rubber | | | 1144RK | 1 | \$160.00 |
| 5° Offset Plate Kit | | | CPLATE003 | 1 | \$232.00 |
| Radius Arm Spacer | | 15mm | 833WT | 1 | \$88.00 |
| 4° Drop Box | | | DBOX003 | 1 | \$406.00 |

STEERING RODS

| | | | | | |
|----------------------|--|--|---------------|---|----------|
| Adjustable Drag Link | | | ADL003 | 1 | \$507.00 |
| Track Rod | | | ATRO03 | 1 | \$507.00 |

ADJUSTABLE PANHARD ROD

| | | | | | |
|----------------------|--|--|-------------------|---|----------|
| Right Hand Drive Rod | | | PANHARD003 | 1 | \$334.00 |
| Left Hand Drive Rod | | | PANHARD008 | 1 | \$334.00 |

SWAY BAR LINK

| | | | | | |
|------------------------|--|-----------------|-----------------|---|---------|
| Extended Sway Bar Link | | Suits 1-3" Lift | SBEXT006 | 2 | \$88.00 |
| Extended Sway Bar Link | | Suits 4-7" Lift | SBEXT003 | 2 | \$88.00 |

COIL SPACER

| | | | | | |
|-------------------|--|--------------------|---------------|---|---------|
| Polyurethane 15mm | | Provides 10mm Lift | PATF15 | 2 | \$30.00 |
| Polyurethane 30mm | | Provides 25mm Lift | PATF30 | 2 | \$44.00 |

BRAKE HOSE

| | | | | | |
|---------------------|--|----------------|-----------------|---|---------|
| Extended Brake Hose | | Non ABS Models | BHOSE003 | 1 | \$74.00 |
| Extended Brake Hose | | ABS models | BHOSE005 | 2 | \$74.00 |





Y60 GQ / Y61 GU
Cab Chassis (Coil/Coil)

SUSPENSION TO SUIT

Nissan Patrol

Product Description

Part No.

Qty
Req

Retail
ea Inc GST

Please check vehicle date range (if shown) next to product description prior to ordering

REAR SUSPENSION

SHOCK ABSORBER

| | | | | | |
|------------------------------|---------------|--|------------------|---|----------|
| Nitro Gas - Performance | | | 12094GR | 2 | \$160.00 |
| Foam Cell - Performance | | | 24094FE | 2 | \$232.00 |
| Foam Cell - Professional | | | 24094FEP | 2 | \$232.00 |
| Foam Cell - Performance | Suits 4" Lift | | 24094LFE | 2 | \$262.00 |
| Foam Cell - Professional | Suits 4" Lift | | 24094LFEP | 2 | \$262.00 |
| Foam Cell - Performance | Suits 6" Lift | | 24094LFE1 | 2 | \$291.00 |
| Foam Cell Pro - Performance | | | 45094FE | 2 | \$319.00 |
| Foam Cell Pro - Professional | | | 45094FEP | 2 | \$319.00 |
| Foam Cell Pro - Performance | Suits 4" Lift | | 45094LFE | 2 | \$334.00 |
| Foam Cell Pro - Professional | Suits 4" Lift | | 45094LFEP | 2 | \$334.00 |
| Foam Cell Pro - Performance | Suits 6" Lift | | 45094LFE1 | 2 | \$348.00 |

COIL SPRINGS

| | Est. Lift | Additional Load | | | |
|------------------|-----------|-----------------|-----------------|---|----------|
| Medium | 50mm | 0 - 300kg | NISS020B | 1 | \$276.00 |
| Medium - 4" Lift | 100mm | 0 - 300kg | NISS027B | 1 | \$406.00 |
| Medium - 6" Lift | 150mm | 0 - 300kg | NISS044B | 1 | \$479.00 |
| Heavy | 50mm | 300 - 400kg | NISS020C | 1 | \$291.00 |
| Heavy - 4" Lift | 100mm | 400kg - GVM | NISS027C | 1 | \$406.00 |
| Heavy - 6" Lift | 150mm | 400kg - GVM | NISS044C | 1 | \$479.00 |
| Extra Heavy | 50mm | 400kg - GVM | NISS020D | 1 | \$435.00 |

PANHARD ROD

| | | | | | |
|------------------------|--|--|-------------------|---|----------|
| Adjustable Panhard Rod | | | PANHARD004 | 1 | \$334.00 |
|------------------------|--|--|-------------------|---|----------|

ADJUSTABLE TRAILING ARM

| | | | | | |
|--------------------|--|--|---------------|---|----------|
| Upper Trailing Arm | | | UTA003 | 2 | \$218.00 |
| Lower Trailing Arm | | | LTA003 | 2 | \$276.00 |

SWAY BAR LINK

| | | | | | |
|------------------------|-----------------|------------|-----------------|---|---------|
| Extended Sway Bar Link | Suits 1-3" Lift | Right Side | SBEXT006 | 1 | \$88.00 |
| Extended Sway Bar Link | Suits 4-7" Lift | Right Side | SBEXT003 | 1 | \$88.00 |
| Extended Sway Bar Link | Suits 1-3" Lift | Left Side | SBEXT007 | 1 | \$88.00 |
| Extended Sway Bar Link | Suits 4-7" Lift | Left Side | SBEXT004 | 1 | \$88.00 |

COIL SPACER

| | | | | | |
|-------------------|--|--------------------|---------------|---|---------|
| Polyurethane 15mm | | Provides 10mm Lift | PATR15 | 2 | \$30.00 |
| Polyurethane 30mm | | Provides 25mm Lift | PATR30 | 2 | \$44.00 |

BRAKE HOSE

| | | | | | |
|---------------------|--|--|-----------------|---|---------|
| Extended Brake Hose | | | BHOSE004 | 1 | \$74.00 |
|---------------------|--|--|-----------------|---|---------|

BRACKET KIT

| | | | | | |
|--------------------|--|--|----------------|---|----------|
| Coil Drop Out Cone | | | IDOC003 | 1 | \$262.00 |
| Coil Retainer Kit | | | ICR003 | 1 | \$131.00 |

BUSH KIT

| | | | | | |
|--------------------------------|--|-------------------------------|---------------|---|----------|
| Rubber Suspension Arm Bush Kit | | W/ Standard Radius Arm Bushes | 839RK | 1 | \$421.00 |
| Rubber Suspension Arm Bush Kit | | W/ Offset Radius Arm Bushes | 839CRK | 1 | \$421.00 |

LISTING
CONTINUED
OVER THE
PAGE

Nissan Patrol

Y60 GQ / Y61 GU
Cab Chassis (Coil/Coil)



Product Description

Part No.

Qty
Req

Retail
ea Inc GST

Please check vehicle date range (if shown) next to product description prior to ordering

SUSPENSION KIT - Specify Front Coil Springs When Ordering

| | | | | |
|-----------------------------|--------|-----|--------------------|-----------|
| Medium - Nitro Gas | | | NISS037BKG | \$1174.00 |
| Medium - Foam Cell | | | NISS037BKF | \$1463.00 |
| Medium - Foam Cell | 4"Lift | RHD | NISS026BKF | \$4228.00 |
| Medium - Foam Cell | 4"Lift | LHD | NISS026BKFL | \$4228.00 |
| Medium - Foam Cell | 6"Lift | RHD | NISS043BKF | \$4489.00 |
| Medium - Foam Cell | 6"Lift | LHD | NISS043BKFL | \$4489.00 |
| Medium - Foam Cell Pro | | | NISS037BKP | \$1810.00 |
| Medium - Foam Cell Pro | 4"Lift | RHD | NISS026BKP | \$4517.00 |
| Medium - Foam Cell Pro | 4"Lift | LHD | NISS026BKPL | \$4517.00 |
| Medium - Foam Cell Pro | 6"Lift | RHD | NISS043BKP | \$4720.00 |
| Medium - Foam Cell Pro | 6"Lift | LHD | NISS043BKPL | \$4720.00 |
| Heavy - Nitro Gas | | | NISS037CKG | \$1188.00 |
| Heavy - Foam Cell | | | NISS037CKF | \$1477.00 |
| Heavy - Foam Cell | 4"Lift | RHD | NISS026CKF | \$4228.00 |
| Heavy - Foam Cell | 4"Lift | LHD | NISS026CKFL | \$4228.00 |
| Heavy - Foam Cell | 6"Lift | RHD | NISS043CKF | \$4489.00 |
| Heavy - Foam Cell | 6"Lift | LHD | NISS043CKFL | \$4489.00 |
| Heavy - Foam Cell Pro | | | NISS037CKP | \$1825.00 |
| Heavy - Foam Cell Pro | 4"Lift | RHD | NISS026CKP | \$4517.00 |
| Heavy - Foam Cell Pro | 4"Lift | LHD | NISS026CKPL | \$4517.00 |
| Heavy - Foam Cell Pro | 6"Lift | RHD | NISS043CKP | \$4720.00 |
| Heavy - Foam Cell Pro | 6"Lift | LHD | NISS043CKPL | \$4720.00 |
| Extra Heavy - Nitro Gas | | | NISS037DKG | \$1333.00 |
| Extra Heavy - Foam Cell | | | NISS037DKF | \$1530.00 |
| Extra Heavy - Foam Cell Pro | | | NISS037DKP | \$1969.00 |

• Specify ABS / non-ABS brake hoses when ordering suspension kits

• 4" and 6" lifts may not be legal for on-road use in your area, certification may be required for on-road use

• Due to the extreme nature of 4" and 6" lifts, further modifications may be required, and will vary between vehicles

Such modifications are entirely the owners responsibility. Ironman 4x4 accept no responsibility for any damage or injury caused by use of the these products

50MM SUSPENSION KIT CONTENTS

4" AND 6" SUSPENSION KIT CONTENTS

Shock Absorbers

Coil Springs

Shock Absorbers

Coil Springs

Panhard Rods

Sway Bar Links

Caster Plates

Brake Hoses

Adjustable Trailing Arms

Nissan Patrol



Y60 GQ / Y61 GU
Cab Chassis (Coil/Leaf)

| Product Description | Part No. | Qty Req | Retail ea Inc GST |
|---------------------|----------|------------|----------------------|
|---------------------|----------|------------|----------------------|

Please check vehicle date range (if shown) next to product description prior to ordering

SUSPENSION TO SUIT NISSAN PATROL Y60 / Y61 - COIL/LEAF

FRONT SUSPENSION

SHOCK ABSORBER

| | | | |
|------------------------------|----------|---|----------|
| Nitro Gas - Performance | 12091GR | 2 | \$160.00 |
| Foam Cell - Performance | 24091FE | 2 | \$232.00 |
| Foam Cell Pro - Performance | 45091FE | 2 | \$319.00 |
| Foam Cell Pro - Professional | 45091FEP | 2 | \$319.00 |

COIL SPRINGS

| | Est. Lift | Additional Load | | | |
|--------|-----------|-----------------|----------|---|----------|
| Medium | 50mm | 0 - 50kg | NISS024B | 1 | \$262.00 |
| Heavy | 50mm | 50 - 110kg | NISS009C | 1 | \$262.00 |

STEERING DAMPER

| | | | |
|-----------|------|---|----------|
| Foam Cell | 3511 | 1 | \$175.00 |
|-----------|------|---|----------|

CASTER CORRECTION

| | | | |
|-----------------------------------|-----------|---|----------|
| 2° Offset Bush Kit - Polyurethane | 1144SK | 1 | \$160.00 |
| 2° Offset Bush Kit - Rubber | 1144RK | 1 | \$160.00 |
| 5° Offset Plate Kit | CPLATE003 | 1 | \$232.00 |
| Radius Arm Spacer | 833WT | 1 | \$88.00 |
| 4° Drop Box | DBOX003 | 1 | \$406.00 |

CROSSMEMBER SPACER

| | | | |
|-----------------------|-------|---|----------|
| 6mm / 12mm Spacer Kit | 1002K | 1 | \$102.00 |
|-----------------------|-------|---|----------|

STEERING RODS

| | | | |
|----------------------|--------|---|----------|
| Adjustable Drag Link | ADL003 | 1 | \$507.00 |
| Track Rod | ATRO03 | 1 | \$507.00 |

ADJUSTABLE PANHARD ROD

| | | | |
|----------------------|------------|---|----------|
| Right Hand Drive Rod | PANHARD003 | 1 | \$334.00 |
| Left Hand Drive Rod | PANHARD008 | 1 | \$334.00 |

SWAY BAR LINK

| | | | | |
|------------------------|-----------------|----------|---|---------|
| Extended Sway Bar Link | Suits 1-3" Lift | SBEXT006 | 2 | \$88.00 |
|------------------------|-----------------|----------|---|---------|

COIL SPACER

| | | | | |
|-------------------|--------------------|--------|---|---------|
| Polyurethane 15mm | Provides 10mm Lift | PATF15 | 2 | \$30.00 |
| Polyurethane 30mm | Provides 25mm Lift | PATF30 | 2 | \$44.00 |

BRAKE HOSE

| | | | |
|---------------------|----------|---|---------|
| Extended Brake Hose | BHOSE003 | 1 | \$74.00 |
|---------------------|----------|---|---------|

REAR SUSPENSION

SHOCK ABSORBER

| | | | |
|-----------------------------|---------|---|----------|
| Nitro Gas - Performance | 12648GR | 2 | \$160.00 |
| Foam Cell - Performance | 24648FE | 2 | \$232.00 |
| Foam Cell Pro - Performance | 45648FE | 2 | \$319.00 |

LEAF SPRINGS

| | Est. Lift | Additional Load | | | |
|----------------------------|-----------|-----------------|-------------|---|----------|
| Heavy - Drivers Side | 50mm | 0 - 400kg | NISS012CD/S | 1 | \$551.00 |
| Heavy - Near Side | 50mm | 0 - 400kg | NISS012CN/S | 1 | \$551.00 |
| Extra Heavy - Drivers Side | 50mm | 400kg - GVM | NISS012DD/S | 1 | \$638.00 |
| Extra Heavy - Near Side | 50mm | 400kg - GVM | NISS012DN/S | 1 | \$638.00 |

U-BOLTS

| | | | | |
|------------|----------------|----------|---|---------|
| U-Bolt Kit | | 1100UBK | 2 | \$44.00 |
| U-Bolt Kit | Suits NISS012D | 1100UBKL | 2 | \$44.00 |

POLYURETHANE SPRING BUSHES

| | | | |
|----------|-------|---|---------|
| Bush Kit | 719UK | 1 | \$74.00 |
|----------|-------|---|---------|

GREASABLE SHACKLES AND PINS

| | | | | |
|-------------------|-----------------|-------|---|---------|
| Greasable Shackle | Left Hand Side | 353LH | 1 | \$74.00 |
| Greasable Shackle | Right Hand Side | 353RH | 1 | \$74.00 |
| Greasable Pin | | 667 | 2 | \$44.00 |

HELPER SPRINGS

| | | | |
|--------------------------|-----|---|----------|
| Load Plus Helper Springs | LP4 | 1 | \$165.00 |
|--------------------------|-----|---|----------|

SUSPENSION KIT - Specify Front Coil Springs When Ordering

| | | |
|-----------------------------|------------|-----------|
| Heavy - Nitro Gas | NISS036CKG | \$2157.00 |
| Heavy - Foam Cell | NISS036CKF | \$2448.00 |
| Heavy - Foam Cell Pro | NISS036CKP | \$2795.00 |
| Extra Heavy - Nitro Gas | NISS036DKG | \$2245.00 |
| Extra Heavy - Foam Cell | NISS036DKF | \$2535.00 |
| Extra Heavy - Foam Cell Pro | NISS036DKP | \$2968.00 |

SUSPENSION KIT CONTENTS

| | | |
|-----------------|--------------|----------------------------|
| Shock Absorbers | Leaf Springs | Polyurethane Spring Bushes |
| Coil Springs | U-Bolts | |



Nissan Patrol

Y60 GQ Station Wagon and Coil Cab
1987 to 1997



Product Description

Part No.

Qty
Req

Retail
ea Inc GST

Please check vehicle date range (if shown) next to product description prior to ordering

ACCESSORIES TO SUIT NISSAN PATROL Y60 - 1987-1997

STEEL WINCH BULL BARS

Commercial Deluxe

BBCD010

\$2345.00

LOCKSAFE DRAWER SYSTEMS

Twin Drawers - 1000mm

ITD1000

\$1355.00

Single Drawer - 1000mm

ISD1000

\$820.00

SNORKEL

All Models Except 2.8L Diesel

ISNORKEL011

\$437.00

STEEL ROOF RACKS

Cage Style - 1.4m x 1.25m

IRRCAGE14

\$812.00

Cage Style - 1.8m x 1.25m

IRRCAGE18

\$852.00

Cage Style - 2.2m x 1.25m

IRRCAGE22

\$885.00

Rooftop Tent Compatible - 1.8m x 1.25m

IRRTENT18

\$812.00

Rooftop Tent Compatible - 2.2m x 1.25m

IRRTENT22

\$852.00

Trade Style - 1.8m x 1.25m (Open end)

IRRTRADE18

\$812.00

Trade Style - 2.2m x 1.25m (Open end)

IRRTRADE22

\$846.00

ALLOY ROOF RACKS

Cage Style - 1.4m x 1.25m

IRRCAGE14-ALLOY

\$1028.00

Cage Style - 1.8m x 1.25m

IRRCAGE18-ALLOY

\$1201.00

Cage Style - 2.2m x 1.25m

IRRCAGE22-ALLOY

\$1267.00

Trade Style - 1.4m x 1.25m (Open end)

IRROPEN14-ALLOY

\$1015.00

Trade Style - 1.8m x 1.25m (Open end)

IRRTRADE18-ALLOY

\$1183.00

Trade Style - 2.2m x 1.25m (Open end)

IRRTRADE22-ALLOY

\$1235.00

Flat Rack - 1.8m x 1.25m

IRRFLAT18-ALLOY

\$1167.00

STEEL AND ALLOY ROOF RACK - MOUNT KITS

Gutter Mount Feet - 125mm (8 Feet - Does not fit high roof model)

IRRFEET125

\$207.00

Gutter Mount Feet - 210mm (8 Feet - Fits high roof model)

IRRFEET210

\$228.00

BREATHER KIT

Universal Twin Manifold Filtered Breather Kit

IDIFFBRE

\$115.00

Nissan Patrol



Y60 GQ Cab Chassis (Leaf/Leaf)
1988+

Product Description

Part No.

Qty
ReqRetail
ea Inc GST

Please check vehicle date range (if shown) next to product description prior to ordering

SUSPENSION TO SUIT NISSAN PATROL Y60 - 1988+

FRONT SUSPENSION

SHOCK ABSORBER

| | | | | | |
|-----------------------------|--|--|----------------|---|----------|
| Nitro Gas - Performance | | | 12661GR | 2 | \$160.00 |
| Foam Cell - Performance | | | 24661FE | 2 | \$232.00 |
| Foam Cell Pro - Performance | | | 45661FE | 2 | \$319.00 |

LEAF SPRINGS

| | Est. Lift | Additional Load | | | |
|----------------------|-----------|-----------------|--------------------|---|----------|
| Heavy - Drivers Side | 50mm | 0 - 110kg | NISS011CD/S | 1 | \$421.00 |
| Heavy - Near Side | 50mm | 0 - 110kg | NISS011CN/S | 1 | \$421.00 |

STEERING DAMPER

| | | | | | |
|-----------|--|--|-------------|---|----------|
| Foam Cell | | | 3522 | 1 | \$175.00 |
|-----------|--|--|-------------|---|----------|

U-BOLTS

| | | | | | |
|-------------------------|--|--|---------------|---|---------|
| Drivers Side U-Bolt Kit | | | 669UBK | 1 | \$44.00 |
| Near Side U-Bolt Kit | | | 436UBK | 1 | \$44.00 |

POLYURETHANE SPRING BUSHES

| | | | | | |
|----------|--|--|--------------|---|---------|
| Bush Kit | | | 718UK | 1 | \$74.00 |
|----------|--|--|--------------|---|---------|

GREASABLE SHACKLES AND PINS

| | | | | | |
|-------------------|-----------------|--|--------------|---|---------|
| Greasable Shackle | Left Hand Side | | 353RH | 1 | \$74.00 |
| Greasable Shackle | Right Hand Side | | 353LH | 1 | \$74.00 |
| Greasable Pin | | | 667 | 2 | \$44.00 |

REAR SUSPENSION

SHOCK ABSORBER

| | | | | | |
|-----------------------------|--|--|----------------|---|----------|
| Nitro Gas - Performance | | | 12648GR | 2 | \$160.00 |
| Foam Cell - Performance | | | 24648FE | 2 | \$232.00 |
| Foam Cell Pro - Performance | | | 45648FE | 2 | \$319.00 |

LEAF SPRINGS

| | Est. Lift | Additional Load | | | |
|----------------------------|-----------|-----------------|--------------------|---|----------|
| Heavy - Drivers Side | 50mm | 0 - 400kg | NISS012CD/S | 1 | \$551.00 |
| Heavy - Near Side | 50mm | 0 - 400kg | NISS012CN/S | 1 | \$551.00 |
| Extra Heavy - Drivers Side | 50mm | 400kg - GVM | NISS012DD/S | 1 | \$638.00 |
| Extra Heavy - Near Side | 50mm | 400kg - GVM | NISS012DN/S | 1 | \$638.00 |

U-BOLTS

| | | | | | |
|------------|--|--|---------------|---|---------|
| U-Bolt Kit | | | 670UBK | 2 | \$44.00 |
|------------|--|--|---------------|---|---------|

POLYURETHANE SPRING BUSHES

| | | | | | |
|----------|--|--|--------------|---|---------|
| Bush Kit | | | 719UK | 1 | \$74.00 |
|----------|--|--|--------------|---|---------|

GREASABLE SHACKLES AND PINS

| | | | | | |
|-------------------|-----------------|--|--------------|---|---------|
| Greasable Shackle | Left Hand Side | | 353LH | 1 | \$74.00 |
| Greasable Shackle | Right Hand Side | | 353RH | 1 | \$74.00 |
| Greasable Pin | | | 667 | 2 | \$44.00 |

HELPER SPRINGS

| | | | | | |
|--------------------------|--|--|------------|---|----------|
| Load Plus Helper Springs | | | LP4 | 1 | \$165.00 |
|--------------------------|--|--|------------|---|----------|

SUSPENSION KIT

| | | |
|-----------------------------|-------------------|-----------|
| Heavy - Nitro Gas | NISS011CKG | \$2896.00 |
| Heavy - Foam Cell | NISS011CKF | \$3186.00 |
| Heavy - Foam Cell Pro | NISS011CKP | \$3533.00 |
| Extra Heavy - Nitro Gas | NISS011DKG | \$2983.00 |
| Extra Heavy - Foam Cell | NISS011DKF | \$3272.00 |
| Extra Heavy - Foam Cell Pro | NISS011DKP | \$3707.00 |

SUSPENSION KIT CONTENTS

| | |
|-----------------|----------------------------|
| Shock Absorbers | U-Bolts |
| Leaf Springs | Polyurethane Spring Bushes |

Nissan Patrol

Y60 GQ LWB Wagon
1988 to 1998



Product Description

Part No.

Qty
Req

Retail
ea Inc GST

Please check vehicle date range (if shown) next to product description prior to ordering

SUSPENSION TO SUIT NISSAN PATROL Y60 - 1988-1998

FRONT SUSPENSION

SHOCK ABSORBER

| | | | | | |
|------------------------------|--|---------------|------------------|---|----------|
| Nitro Gas - Performance | | | 12091GR | 2 | \$160.00 |
| Foam Cell - Performance | | | 24091FE | 2 | \$232.00 |
| Foam Cell - Professional | | | 24091FEP | 2 | \$232.00 |
| Foam Cell - Performance | | Suits 4" Lift | 24091LFE | 2 | \$262.00 |
| Foam Cell - Performance | | Suits 6" Lift | 24091LFE1 | 2 | \$291.00 |
| Foam Cell Pro - Performance | | | 45091FE | 2 | \$319.00 |
| Foam Cell Pro - Professional | | | 45091FEP | 2 | \$319.00 |
| Foam Cell Pro - Performance | | Suits 4" Lift | 45091LFE | 2 | \$334.00 |
| Foam Cell Pro - Professional | | Suits 4" Lift | 45091LFEP | 2 | \$334.00 |
| Foam Cell Pro - Performance | | Suits 6" Lift | 45091LFE1 | 2 | \$348.00 |

COIL SPRINGS

| | Est. Lift | Additional Load | | | |
|------------------|-----------|-----------------|-----------------|---|----------|
| Medium | 50mm | 0 - 50kg | NISS009B | 1 | \$262.00 |
| Heavy | 50mm | 50 - 110kg | NISS009C | 1 | \$262.00 |
| Medium - 4" Lift | 100mm | 0 - 100kg | NISS026B | 1 | \$406.00 |
| Medium - 6" Lift | 150mm | 0 - 100kg | NISS043B | 1 | \$479.00 |

STEERING DAMPER

| | | | | |
|-----------|------------|-------------|---|----------|
| Foam Cell | Pre 8/1989 | 3534 | 1 | \$175.00 |
| Foam Cell | 8/1989+ | 3536 | 1 | \$175.00 |

CASTER CORRECTION

| | | | | |
|-----------------------------------|------|------------------|---|----------|
| 2° Offset Bush Kit - Polyurethane | | 1144SK | 1 | \$160.00 |
| 2° Offset Bush Kit - Rubber | | 1144RK | 1 | \$160.00 |
| 5° Offset Plate Kit | | CPLATE003 | 1 | \$232.00 |
| Radius Arm Spacer | 15mm | 833WT | 1 | \$88.00 |
| 4° Drop Box | | DBOX003 | 1 | \$406.00 |

CROSSMEMBER SPACER

| | | | | |
|-----------------------|--|--------------|---|----------|
| 6mm / 12mm Spacer Kit | | 1002K | 1 | \$102.00 |
|-----------------------|--|--------------|---|----------|

STEERING RODS

| | | | | |
|----------------------|--|---------------|---|----------|
| Adjustable Drag Link | | ADL003 | 1 | \$507.00 |
| Track Rod | | ATRO03 | 1 | \$507.00 |

ADJUSTABLE PANHARD ROD

| | | | | |
|----------------------|--|-------------------|---|----------|
| Right Hand Drive Rod | | PANHARD003 | 1 | \$334.00 |
| Left Hand Drive Rod | | PANHARD008 | 1 | \$334.00 |

SWAY BAR LINK

| | | | | |
|------------------------|-----------------|-----------------|---|---------|
| Extended Sway Bar Link | Suits 1-3" Lift | SBEXT006 | 2 | \$88.00 |
| Extended Sway Bar Link | Suits 4-7" Lift | SBEXT003 | 2 | \$88.00 |

COIL SPACER

| | | | | |
|-------------------|--------------------|---------------|---|---------|
| Polyurethane 15mm | Provides 10mm Lift | PATF15 | 2 | \$30.00 |
| Polyurethane 30mm | Provides 25mm Lift | PATF30 | 2 | \$44.00 |

BRAKE HOSE

| | | | | |
|---------------------|--|-----------------|---|---------|
| Extended Brake Hose | | BHOSE003 | 1 | \$74.00 |
|---------------------|--|-----------------|---|---------|

REAR SUSPENSION

SHOCK ABSORBER

| | | | | | |
|------------------------------|--|---------------|------------------|---|----------|
| Nitro Gas - Performance | | | 12094GR | 2 | \$160.00 |
| Foam Cell - Performance | | | 24094FE | 2 | \$232.00 |
| Foam Cell - Professional | | | 24094FEP | 2 | \$232.00 |
| Foam Cell - Performance | | Suits 4" Lift | 24094LFE | 2 | \$262.00 |
| Foam Cell - Professional | | Suits 4" Lift | 24094LFEP | 2 | \$262.00 |
| Foam Cell - Performance | | Suits 6" Lift | 24094LFE1 | 2 | \$291.00 |
| Foam Cell Pro - Performance | | | 45094FE | 2 | \$319.00 |
| Foam Cell Pro - Professional | | | 45094FEP | 2 | \$319.00 |
| Foam Cell Pro - Performance | | Suits 4" Lift | 45094LFE | 2 | \$334.00 |
| Foam Cell Pro - Professional | | Suits 4" Lift | 45094LFEP | 2 | \$334.00 |
| Foam Cell Pro - Performance | | Suits 6" Lift | 45094LFE1 | 2 | \$348.00 |

Nissan Patrol



Y60 GQ LWB Wagon
1988 to 1998

| Product Description | Part No. | Qty Req | Retail ea Inc GST |
|---|-------------------------------|-----------------|----------------------------|
| <i>Please check vehicle date range (if shown) next to product description prior to ordering</i> | | | |
| COIL SPRINGS | Est. Lift | Additional Load | |
| Medium | 50mm | 0 - 200kg | NISS010B 1 \$262.00 |
| Medium - 4" Lift | 100mm | 0 - 300kg | NISS027B 1 \$406.00 |
| Medium - 6" Lift | 150mm | 0 - 300kg | NISS044B 1 \$479.00 |
| Heavy | 50mm | 200 - 400kg | NISS010C 1 \$276.00 |
| Heavy | 50mm | 400 - 600kg | NISS020C 1 \$291.00 |
| Heavy - 4" Lift | 100mm | 400kg - GVM | NISS027C 1 \$406.00 |
| Heavy - 6" Lift | 150mm | 400kg - GVM | NISS044C 1 \$479.00 |
| Extra Heavy | 50mm | 600kg - GVM | NISS020D 1 \$435.00 |
| PANHARD ROD | | | |
| Adjustable Panhard Rod | PANHARD004 | 1 | \$334.00 |
| ADJUSTABLE TRAILING ARM | | | |
| Upper Trailing Arm | UTA003 | 2 | \$218.00 |
| Lower Trailing Arm | LTA003 | 2 | \$276.00 |
| SWAY BAR LINK | | | |
| Extended Sway Bar Link | Suits 1-3" Lift | SBEXT006 | 2 \$88.00 |
| Extended Sway Bar Link | Suits 4-7" Lift | SBEXT003 | 2 \$88.00 |
| COIL SPACER | | | |
| Polyurethane 15mm | Provides 10mm Lift | PATR15 | 2 \$30.00 |
| Polyurethane 30mm | Provides 25mm Lift | PATR30 | 2 \$44.00 |
| BRAKE HOSE | | | |
| Extended Brake Hose | BHOSE004 | 1 | \$74.00 |
| BRACKET KIT | | | |
| Coil Drop Out Cone | IDOC003 | 1 | \$262.00 |
| Coil Retainer Kit | ICRO03 | 1 | \$131.00 |
| BUSH KIT | | | |
| Rubber Suspension Arm Bush Kit | W/ Standard Radius Arm Bushes | 839RK | 1 \$421.00 |
| Rubber Suspension Arm Bush Kit | W/ Offset Radius Arm Bushes | 839CRK | 1 \$421.00 |

SUSPENSION KIT - Specify Front Coil Springs When Ordering

| | | | |
|-----------------------------|---------|--------------------|-----------|
| Medium - Nitro Gas | | NISS009BKG | \$1159.00 |
| Medium - Foam Cell | | NISS009BKF | \$1449.00 |
| Medium - Foam Cell | 4" Lift | NISS026BKF | \$4228.00 |
| Medium - Foam Cell | 4" Lift | NISS026BKFL | \$4228.00 |
| Medium - Foam Cell | 6" Lift | NISS043BKF | \$4489.00 |
| Medium - Foam Cell | 6" Lift | NISS043BKFL | \$4489.00 |
| Medium - Foam Cell Pro | | NISS009BKP | \$1796.00 |
| Medium - Foam Cell Pro | 4" Lift | NISS026BKP | \$4517.00 |
| Medium - Foam Cell Pro | 4" Lift | NISS026BKPL | \$4517.00 |
| Medium - Foam Cell Pro | 6" Lift | NISS043BKP | \$4720.00 |
| Medium - Foam Cell Pro | 6" Lift | NISS043BKPL | \$4720.00 |
| Heavy - Nitro Gas | | NISS009CKG | \$1174.00 |
| Heavy - Foam Cell | | NISS009CKF | \$1463.00 |
| Heavy - Foam Cell | 4" Lift | NISS026CKF | \$4228.00 |
| Heavy - Foam Cell | 4" Lift | NISS026CKFL | \$4228.00 |
| Heavy - Foam Cell | 6" Lift | NISS043CKF | \$4489.00 |
| Heavy - Foam Cell | 6" Lift | NISS043CKFL | \$4489.00 |
| Heavy - Foam Cell Pro | | NISS009CKP | \$1810.00 |
| Heavy - Foam Cell Pro | 4" Lift | NISS026CKP | \$4517.00 |
| Heavy - Foam Cell Pro | 4" Lift | NISS026CKPL | \$4517.00 |
| Heavy - Foam Cell Pro | 6" Lift | NISS043CKP | \$4720.00 |
| Heavy - Foam Cell Pro | 6" Lift | NISS043CKPL | \$4720.00 |
| Extra Heavy - Nitro Gas | | NISS020CKG | \$1188.00 |
| Extra Heavy - Foam Cell | | NISS020CKF | \$1477.00 |
| Extra Heavy - Foam Cell Pro | | NISS020CKP | \$1825.00 |
| Super Heavy - Nitro Gas | | NISS024DKG | \$1333.00 |
| Super Heavy - Foam Cell | | NISS024DKF | \$1622.00 |
| Super Heavy - Foam Cell Pro | | NISS024DKP | \$1969.00 |

• 4" and 6" lifts may not be legal for on-road use in your area, certification may be required for on-road use

• Due to the extreme nature of 4" and 6" lifts, further modifications may be required, and will vary between vehicles

Such modifications are entirely the owners responsibility. Ironman 4x4 accept no responsibility for any damage or injury caused by use of the these products

50MM SUSPENSION KIT CONTENTS

Shock Absorbers Coil Springs

4" AND 6" SUSPENSION KIT CONTENTS

Shock Absorbers Caster Plates
Coil Springs Brake Hoses
Panhard Rods Adjustable Trailing Arms
Sway Bar Links



Nissan Patrol

Y60 GQ SWB Wagon
1988 to 1998



Product Description

Part No.

Qty
Req

Retail
ea Inc GST

Please check vehicle date range (if shown) next to product description prior to ordering

SUSPENSION TO SUIT NISSAN PATROL Y60 - 1988-1998

FRONT SUSPENSION

SHOCK ABSORBER

| | | | | | |
|------------------------------|--|---------------|------------------|---|----------|
| Nitro Gas - Performance | | | 12091GR | 2 | \$160.00 |
| Foam Cell - Performance | | | 24091FE | 2 | \$232.00 |
| Foam Cell - Professional | | | 24091FEP | 2 | \$232.00 |
| Foam Cell - Performance | | Suits 5" Lift | 24091LFE | 2 | \$262.00 |
| Foam Cell - Performance | | Suits 7" Lift | 24091LFE1 | 2 | \$291.00 |
| Foam Cell Pro - Performance | | | 45091FE | 2 | \$319.00 |
| Foam Cell Pro - Professional | | | 45091FEP | 2 | \$319.00 |
| Foam Cell Pro - Performance | | Suits 5" Lift | 45091LFE | 2 | \$334.00 |
| Foam Cell Pro - Professional | | Suits 5" Lift | 45091LFEP | 2 | \$334.00 |
| Foam Cell Pro - Performance | | Suits 7" Lift | 45091LFE1 | 2 | \$348.00 |

COIL SPRINGS

| | Est. Lift | Additional Load | | | |
|------------------|-----------|-----------------|-----------------|---|----------|
| Medium | 50mm | 0 - 50kg | NISS007B | 1 | \$262.00 |
| Medium - 5" Lift | 125mm | 0 - 100kg | NISS026B | 1 | \$406.00 |
| Medium - 7" Lift | 175mm | 0 - 100kg | NISS043B | 1 | \$479.00 |
| Heavy | 50mm | 50 - 110kg | NISS009B | 1 | \$262.00 |

STEERING DAMPER

| | | | | |
|-----------|------------|-------------|---|----------|
| Foam Cell | Pre 8/1989 | 3534 | 1 | \$175.00 |
| Foam Cell | 8/1989+ | 3536 | 1 | \$175.00 |

CASTER CORRECTION

| | | | | |
|-----------------------------------|------|------------------|---|----------|
| 2° Offset Bush Kit - Polyurethane | | 1144SK | 1 | \$160.00 |
| 2° Offset Bush Kit - Rubber | | 1144RK | 1 | \$160.00 |
| 5° Offset Plate Kit | | CPLATE003 | 1 | \$232.00 |
| Radius Arm Spacer | 15mm | 833WT | 1 | \$88.00 |
| 4° Drop Box | | DBOX003 | 1 | \$406.00 |

CROSSMEMBER SPACER

| | | | | |
|-----------------------|--|--------------|---|----------|
| 6mm / 12mm Spacer Kit | | 1002K | 1 | \$102.00 |
|-----------------------|--|--------------|---|----------|

STEERING RODS

| | | | | |
|----------------------|--|---------------|---|----------|
| Adjustable Drag Link | | ADL003 | 1 | \$507.00 |
| Track Rod | | ATRO03 | 1 | \$507.00 |

ADJUSTABLE PANHARD ROD

| | | | | |
|----------------------|--|-------------------|---|----------|
| Right Hand Drive Rod | | PANHARD003 | 1 | \$334.00 |
| Left Hand Drive Rod | | PANHARD008 | 1 | \$334.00 |

SWAY BAR LINK

| | | | | |
|------------------------|-----------------|-----------------|---|---------|
| Extended Sway Bar Link | Suits 1-3" Lift | SBEXT006 | 2 | \$88.00 |
| Extended Sway Bar Link | Suits 4-7" Lift | SBEXT003 | 2 | \$88.00 |

COIL SPACER

| | | | | |
|-------------------|--------------------|---------------|---|---------|
| Polyurethane 15mm | Provides 10mm Lift | PATF15 | 2 | \$30.00 |
| Polyurethane 30mm | Provides 25mm Lift | PATF30 | 2 | \$44.00 |

BRAKE HOSE

| | | | | |
|---------------------|--|-----------------|---|---------|
| Extended Brake Hose | | BHOSE003 | 1 | \$74.00 |
|---------------------|--|-----------------|---|---------|

REAR SUSPENSION

SHOCK ABSORBER

| | | | | | |
|------------------------------|--|---------------|------------------|---|----------|
| Nitro Gas - Performance | | | 12094GR | 2 | \$160.00 |
| Foam Cell - Performance | | | 24094FE | 2 | \$232.00 |
| Foam Cell - Professional | | | 24094FEP | 2 | \$232.00 |
| Foam Cell - Performance | | Suits 5" Lift | 24094LFE | 2 | \$262.00 |
| Foam Cell - Professional | | Suits 5" Lift | 24094LFEP | 2 | \$262.00 |
| Foam Cell - Performance | | Suits 7" Lift | 24094LFE1 | 2 | \$291.00 |
| Foam Cell Pro - Performance | | | 45094FE | 2 | \$319.00 |
| Foam Cell Pro - Professional | | | 45094FEP | 2 | \$319.00 |
| Foam Cell Pro - Performance | | Suits 5" Lift | 45094LFE | 2 | \$334.00 |
| Foam Cell Pro - Professional | | Suits 5" Lift | 45094LFEP | 2 | \$334.00 |
| Foam Cell Pro - Performance | | Suits 7" Lift | 45094LFE1 | 2 | \$348.00 |

Nissan Patrol



Y60 GQ SWB Wagon
1988 to 1998

| Product Description | Part No. | Qty Req | Retail ea Inc GST |
|---|-------------------------------|-----------------|----------------------------|
| <i>Please check vehicle date range (if shown) next to product description prior to ordering</i> | | | |
| COIL SPRINGS | Est. Lift | Additional Load | |
| Medium | 50mm | 0 - 200kg | NISS008B 1 \$262.00 |
| Medium - 5" Lift | 125mm | 0 - 300kg | NISS027B 1 \$406.00 |
| Medium - 7" Lift | 175mm | 0 - 300kg | NISS044B 1 \$479.00 |
| Heavy | 50mm | 200 - 400kg | NISS010B 1 \$262.00 |
| Extra Heavy | 55mm | 400kg - GVM | NISS010C 1 \$276.00 |
| PANHARD ROD | | | |
| Adjustable Panhard Rod | PANHARD004 | 1 | \$334.00 |
| ADJUSTABLE TRAILING ARM | | | |
| Upper Trailing Arm | UTA003 | 2 | \$218.00 |
| Lower Trailing Arm | LTA003 | 2 | \$276.00 |
| SWAY BAR LINK | | | |
| Extended Sway Bar Link | Suits 1-3"Lift | SBEXT006 | 2 \$88.00 |
| Extended Sway Bar Link | Suits 4-7"Lift | SBEXT003 | 2 \$88.00 |
| COIL SPACER | | | |
| Polyurethane 15mm | Provides 10mm Lift | PATR15 | 2 \$30.00 |
| Polyurethane 30mm | Provides 25mm Lift | PATR30 | 2 \$44.00 |
| BRAKE HOSE | | | |
| Extended Brake Hose | BHOSE004 | 1 | \$74.00 |
| BRACKET KIT | | | |
| Coil Drop Out Cone | IDOC003 | 1 | \$262.00 |
| Coil Retainer Kit | ICRO03 | 1 | \$131.00 |
| BUSH KIT | | | |
| Rubber Suspension Arm Bush Kit | W/ Standard Radius Arm Bushes | 839RK | 1 \$421.00 |
| Rubber Suspension Arm Bush Kit | W/ Offset Radius Arm Bushes | 839CRK | 1 \$421.00 |

SUSPENSION KIT - Specify Front Coil Springs When Ordering

| | | | |
|-----------------------------|--------|--------------------|-----------|
| Medium - Nitro Gas | | NISS007BKG | \$1159.00 |
| Medium - Foam Cell | | NISS007BKF | \$1449.00 |
| Medium - Foam Cell | 5"Lift | NISS026BKF | \$4228.00 |
| Medium - Foam Cell | 5"Lift | NISS026BKFL | \$4228.00 |
| Medium - Foam Cell | 7"Lift | NISS043BKF | \$4489.00 |
| Medium - Foam Cell | 7"Lift | NISS043BKFL | \$4489.00 |
| Medium - Foam Cell Pro | | NISS007BKP | \$1796.00 |
| Medium - Foam Cell Pro | 5"Lift | NISS026BKP | \$4517.00 |
| Medium - Foam Cell Pro | 5"Lift | NISS026BKPL | \$4517.00 |
| Medium - Foam Cell Pro | 7"Lift | NISS043BKP | \$4720.00 |
| Medium - Foam Cell Pro | 7"Lift | NISS043BKPL | \$4720.00 |
| Heavy - Nitro Gas | | NISS009BKG | \$1159.00 |
| Heavy - Foam Cell | | NISS009BKF | \$1449.00 |
| Heavy - Foam Cell Pro | | NISS009BKP | \$1796.00 |
| Extra Heavy - Nitro Gas | | NISS009BKG1 | \$1174.00 |
| Extra Heavy - Foam Cell | | NISS009BKF1 | \$1463.00 |
| Extra Heavy - Foam Cell Pro | | NISS009BKP1 | \$1810.00 |

• 5" and 7" lifts may not be legal for on-road use in your area, certification may be required for on-road use

• Due to the extreme nature of 5" and 7" lifts, further modifications may be required, and will vary between vehicles

Such modifications are entirely the owners responsibility. Ironman 4x4 accept no responsibility for any damage or injury caused by use of the these products

50MM SUSPENSION KIT CONTENTS

Shock Absorbers Coil Springs

4" AND 6" SUSPENSION KIT CONTENTS

Shock Absorbers Caster Plates
Coil Springs Brake Hoses
Panhard Rods Adjustable Trailing Arms
Sway Bar Links



Nissan Patrol

MK G160 (Rectangle Headlights)
1984+



Product Description

Part No.

Qty
Req

Retail
ea Inc GST

Please check vehicle date range (if shown) next to product description prior to ordering

SUSPENSION TO SUIT NISSAN PATROL MK - 1984+

FRONT SUSPENSION

SHOCK ABSORBER

| | | | | | |
|-------------------------|--|--|----------------|---|----------|
| Nitro Gas - Performance | | | 12075GR | 2 | \$160.00 |
|-------------------------|--|--|----------------|---|----------|

LEAF SPRINGS

| | Est. Lift | Additional Load | | | |
|--------------------------------|-----------|-----------------|--------------------|---|----------|
| Medium - Drivers Side (Petrol) | 45mm | 0 - 50kg | NISS005BD/S | 1 | \$392.00 |
| Medium - Near Side (Petrol) | 45mm | 0 - 50kg | NISS005BN/S | 1 | \$392.00 |

STEERING DAMPER

| | | | | | |
|-----------|--|--|-------------|---|----------|
| Foam Cell | | | 3522 | 1 | \$175.00 |
|-----------|--|--|-------------|---|----------|

U-BOLTS

| | | | | | |
|------------|--|--------------|---------------|---|---------|
| U-Bolt Kit | | Drivers side | 452UBK | 1 | \$44.00 |
| U-Bolt Kit | | Near side | 451UBK | 1 | \$44.00 |

POLYURETHANE SPRING BUSHES

| | | | | | |
|----------|--|--|--------------|---|---------|
| Bush Kit | | | 724UK | 1 | \$88.00 |
|----------|--|--|--------------|---|---------|

GREASABLE SHACKLES AND PINS

| | | | | | |
|-------------------|--|---------------------|------------|---|---------|
| Greasable Shackle | | Stepped Side Plates | 665 | 2 | \$74.00 |
| Greasable Pin | | | 470 | 2 | \$44.00 |

REAR SUSPENSION

SHOCK ABSORBER

| | | | | | |
|-------------------------|--|--|----------------|---|----------|
| Nitro Gas - Performance | | | 12076GR | 2 | \$160.00 |
|-------------------------|--|--|----------------|---|----------|

LEAF SPRINGS

| | Est. Lift | Additional Load | | | |
|-----------------------|-----------|-----------------|--------------------|---|----------|
| Medium - Drivers Side | 45mm | 0 - 200kg | NISS004BD/S | 1 | \$421.00 |
| Medium - Near Side | 45mm | 0 - 200kg | NISS004BN/S | 1 | \$421.00 |

U-BOLTS

| | | | | | |
|------------|--|--|---------------|---|---------|
| U-Bolt Kit | | | 453UBK | 2 | \$44.00 |
|------------|--|--|---------------|---|---------|

POLYURETHANE SPRING BUSHES

| | | | | | |
|----------|--|--|--------------|---|---------|
| Bush Kit | | | 722UK | 1 | \$88.00 |
|----------|--|--|--------------|---|---------|

GREASABLE SHACKLES AND PINS

| | | | | | |
|-------------------|--|--|------------|---|---------|
| Greasable Shackle | | | 664 | 2 | \$74.00 |
| Greasable Pin | | | 470 | 2 | \$44.00 |

HELPER SPRINGS

| | | | | | |
|--------------------------|--|--|----------------|---|----------|
| Load Plus Helper Springs | | | LP3 | 1 | \$165.00 |
| Add-A-Leaf | | | ISL6010 | 1 | \$175.00 |

SUSPENSION KIT

| | | | | | |
|--------------------|--|--|-------------------|--|-----------|
| Medium - Nitro Gas | | | NISS005BKG | | \$2607.00 |
|--------------------|--|--|-------------------|--|-----------|

SUSPENSION KIT CONTENTS

| | |
|-----------------|----------------------------|
| Shock Absorbers | U-Bolts |
| Leaf Springs | Polyurethane Spring Bushes |

Nissan Patrol

MQ G160 (Round Headlights)
Pre 1984

Product Description

Part No.

Qty
ReqRetail
ea Inc GST*Please check vehicle date range (if shown) next to product description prior to ordering***SUSPENSION TO SUIT NISSAN PATROL MQ - PRE 1984****FRONT SUSPENSION****SHOCK ABSORBER**Nitro Gas - Performance **12075GR** 2 \$160.00**LEAF SPRINGS**Medium - Drivers Side (Petrol) Est. Lift 45mm Additional Load 0 - 50kg **NISS003BD/S** 1 \$392.00Medium - Near Side (Petrol) 45mm 0 - 50kg **NISS003BN/S** 1 \$392.00**STEERING DAMPER**Foam Cell **3522** 1 \$175.00**U-BOLTS**U-Bolt Kit Drivers side **452UBK** 1 \$44.00U-Bolt Kit Near side **451UBK** 1 \$44.00**STEEL SPRING BUSHES**Bush Kit **721UK** 1 \$88.00**GREASABLE SHACKLES AND PINS**Greasable Shackle Straight Side Plates **355K** 2 \$74.00Greasable Pin **470** 2 \$44.00**REAR SUSPENSION****SHOCK ABSORBER**Nitro Gas - Performance **12076GR** 2 \$160.00**LEAF SPRINGS**Medium - Drivers Side Est. Lift 45mm Additional Load 0 - 200kg **NISS004BD/S** 1 \$421.00Medium - Near Side 45mm 0 - 200kg **NISS004BN/S** 1 \$421.00**U-BOLTS**U-Bolt Kit **453UBK** 2 \$44.00**POLYURETHANE SPRING BUSHES**Bush Kit **722UK** 1 \$88.00**GREASABLE SHACKLES AND PINS**Greasable Shackle **664** 2 \$74.00Greasable Pin **470** 2 \$44.00**HELPER SPRINGS**Load Plus Helper Springs **LP3** 1 \$165.00Add-A-Leaf **ISL6010** 1 \$175.00**SUSPENSION KIT**Medium - Nitro Gas **NISS003BKG** \$2607.00**SUSPENSION KIT CONTENTS**

Shock Absorbers

U-Bolts

Leaf Springs

Polyurethane Spring Bushes

Nissan Xterra

2005+



Product Description

Part No.

Qty
Req

Retail
ea Inc GST

Please check vehicle date range (if shown) next to product description prior to ordering

SUSPENSION TO SUIT NISSAN XTERRA - 2005+

FRONT SUSPENSION

SHOCK ABSORBER

| | | | | | |
|---|--|--|-------------------|---|----------|
| Nitro Gas Strut - Performance | | | 12716GR | 2 | \$232.00 |
| Foam Cell Strut - Performance | | | 24716FE | 2 | \$262.00 |
| Foam Cell Pro Strut - Performance | | | 45716FE | 2 | \$406.00 |
| Foam Cell Pro Strut - Performance - Long Travel* (SEE NOTE) | | | 45716LFE * | 2 | \$406.00 |

*NOTE: MANDATORY FITMENT of Ironman 4x4 UCA048FA is required with Long Travel - Foam Cell Pro

• Foam Cell Pro contains a single adjusting ring for driveshaft clearance

COIL SPRINGS

| | Est. Lift | Additional Load | | | |
|--------|-----------|-----------------|-----------------|---|----------|
| Medium | 35mm | 0 - 50kg | NISS040B | 1 | \$262.00 |
| Heavy | 35mm | 50 - 110kg | NISS040C | 1 | \$262.00 |

STRUT MOUNTS

| | | | | | |
|-----------------|--|--|----------------|---|---------|
| Steel Strut Top | | | ISST007 | 2 | \$88.00 |
|-----------------|--|--|----------------|---|---------|

TRIM PACKERS

| | | | | |
|------------------------|-----------------------|-------------------------|---|---------|
| 5mm Strut Trim Packer | Nitro Gas / Foam Cell | HILFR05/HILFR05F | 2 | \$30.00 |
| 10mm Strut Trim Packer | Nitro Gas / Foam Cell | HILFR10/HILFR10F | 2 | \$30.00 |
| 15mm Strut Trim Packer | Nitro Gas / Foam Cell | HILFR15/HILFR15F | 2 | \$30.00 |

• ONLY Compatible with Ironman 4x4 Struts (Except Pro), lift height subject to 2:1 motion ratio. Unnecessary fitment may lift vehicle too high

CONTROL ARMS

| | | | | | |
|------------------------------|--|--|-----------------|---|----------|
| Pro-Forge Upper Control Arms | | | UCA048FA | 1 | \$882.00 |
|------------------------------|--|--|-----------------|---|----------|

REAR SUSPENSION

SHOCK ABSORBER

| | | | | | |
|------------------------------|--|--|-----------------|---|----------|
| Nitro Gas - Performance | | | 12717GR | 2 | \$160.00 |
| Foam Cell - Performance | | | 24717FE | 2 | \$232.00 |
| Foam Cell - Professional | | | 24717FEP | 2 | \$232.00 |
| Foam Cell Pro - Performance | | | 45717FE | 2 | \$319.00 |
| Foam Cell Pro - Professional | | | 45717FEP | 2 | \$319.00 |

LEAF SPRINGS

| | Est. Lift | Additional Load | | | |
|--------|-----------|-----------------|-----------------|---|----------|
| Medium | 45mm | 0 - 300kg | NISS047B | 2 | \$392.00 |

U-BOLTS

| | | | | | |
|------------|--|--|---------------|---|---------|
| U-Bolt Kit | | | 416UBK | 2 | \$44.00 |
|------------|--|--|---------------|---|---------|

POLYURETHANE SPRING BUSHES

| | | | | | |
|----------|--|--|--------------|---|---------|
| Bush Kit | | | 769UK | 1 | \$88.00 |
|----------|--|--|--------------|---|---------|

GREASABLE SHACKLES AND PINS

| | | | | | |
|-------------------|--|--|--------------|---|---------|
| Greasable Shackle | | | 797-1 | 2 | \$59.00 |
|-------------------|--|--|--------------|---|---------|

HELPER SPRINGS

| | | | | | |
|--------------------------|--|--|----------------|---|----------|
| Load Plus Helper Springs | | | LP2 | 1 | \$165.00 |
| Add-A-Leaf | | | ISL6010 | 1 | \$175.00 |

SUSPENSION KIT - Specify Front Coil Springs When Ordering

| | | |
|------------------------|-------------------|-----------|
| Medium - Nitro Gas | NISS047BKG | \$1999.00 |
| Medium - Foam Cell | NISS047BKF | \$2201.00 |
| Medium - Foam Cell Pro | NISS047BKP | \$2664.00 |

SUSPENSION KIT CONTENTS

Shock Absorbers
Leaf Springs

Coil Springs
U-Bolts

Polyurethane Spring Bushes



T30
2001 to 9/2007

Nissan X-Trail

Product Description

Part No.

Qty
Req

Retail
ea Inc GST

Please check vehicle date range (if shown) next to product description prior to ordering

SUSPENSION TO SUIT NISSAN X-TRAIL T30 - 2001-9/2007

FRONT SUSPENSION

COIL SPRINGS

| | Est. Lift | Additional Load | Part No. | Qty Req | Retail Price |
|--------|-----------|-----------------|----------|---------|--------------|
| Medium | 35mm | 0 - 50kg | NISS038B | 1 | \$262.00 |

CAMBER CORRECTION

| | | | | | |
|-----------------|--|--|-----------|---|---------|
| Camber Bolt Kit | | | ICAMBER12 | 1 | \$30.00 |
|-----------------|--|--|-----------|---|---------|

REAR SUSPENSION

COIL SPRINGS

| | Est. Lift | Additional Load | Part No. | Qty Req | Retail Price |
|--------|-----------|-----------------|----------|---------|--------------|
| Medium | 35mm | 0 - 200kg | NISS039B | 1 | \$262.00 |



Ram 1500

DT
6/2018+



Product Description

Part No.

Qty
Req

Retail
ea Inc GST

Please check vehicle date range (if shown) next to product description prior to ordering

ACCESSORIES TO SUIT RAM 1500 DT - 6/2018+

STEEL WINCH BULL BARS

| | | | |
|---------------------------------------|---------|--|-----------|
| Raid Full Length Steel Tubular Bumper | BBR085E | | \$2064.00 |
|---------------------------------------|---------|--|-----------|

• *Raid Bull Bars are compatible with Ironman 4x4 Lightbars and Cube Lights, refer below for available options*

LIGHTING OPTIONS - TO SUIT RAID BULL BARS

| | | | |
|--|-----------|---|----------|
| 300W Bright Sabre Dual Row Slim Lightbar 815mm (32") Straight | ILBDR002B | 1 | \$417.00 |
| 40W Bright Cube Spot Beam LED Cube Light - 81 x 75mm (Each) - Clear | ILED80B | 2 | \$83.00 |
| 40W Bright Cube Spot Beam LED Cube Light - 81 x 75mm (Each) - Amber | ILED80BA | 2 | \$83.00 |
| 40W Bright Cube Flood Beam LED Cube Light - 81 x 75mm (Each) - Clear | ILED80BF | 2 | \$83.00 |
| 40W Bright Cube Flood Beam LED Cube Light - 81 x 75mm (Each) - Amber | ILED80BFA | 2 | \$83.00 |

STEEL SIDE STEPS AND RAILS

| | | | |
|-----------------|-------|--|-----------|
| Raid Side Steps | SS085 | | \$1098.00 |
|-----------------|-------|--|-----------|

REAR PROTECTION

| | | | |
|---|----------|--|-----------|
| Raid Steel Rear Tubular Bumper - (US Only) | RTB085 | | - |
| Raid Steel Rear Tubular Bumper - (Australia Only) | RTB085AU | | \$1620.00 |

LIGHTING OPTIONS - TO SUIT RAID REAR BARS

| | | | |
|--|-----------|---|---------|
| 20W Bright Cube Spot Beam LED Cube Light - 70 x 64mm (Each) - Clear | ILED20B | 2 | \$62.00 |
| 20W Bright Cube Spot Beam LED Cube Light - 70 x 64mm (Each) - Amber | ILED20BA | 2 | \$62.00 |
| 20W Bright Cube Flood Beam LED Cube Light - 70 x 64mm (Each) - Clear | ILED20BF | 2 | \$62.00 |
| 20W Bright Cube Flood Beam LED Cube Light - 70 x 64mm (Each) - Amber | ILED20BFA | 2 | \$62.00 |
| 20W Bright Cube Flood Beam LED Cube Light - 70 x 64mm (Each) - Red | ILED20BFR | 2 | \$62.00 |

PREMIUM UNDERBODY PROTECTION

| | | | |
|-------------|--------|--|----------|
| Ram 1500 DT | UBP085 | | \$745.00 |
|-------------|--------|--|----------|

SLIDE-AWAY ROLL UP HARD TONNEAU COVER

| | | | |
|--|-----------------|--|-----------|
| Electric with Remote Control (No RamBox) - Crew Cab Only with 5.8' Bed | ISLIDEAWAY075-E | | \$2716.00 |
|--|-----------------|--|-----------|

ATLAS RACK KIT

| | | | |
|--|---------------|--|-----------|
| Platform S with Blade Fit Kit to Suit Slideaway Hard Tonneau Cover - 1390mm Length | IFRSLDAWAYPSK | | \$1670.00 |
| Crossbar (x 2) and Fit Kit to Suit Slideaway Hard Tonneau Cover - 1500mm Width | IFRSLDAWAYC2K | | \$940.00 |

• See Page 36 and 37 for more Atlas rack and crossbar options.

BREATHER KIT

| | | | |
|---|----------|--|----------|
| Universal Twin Manifold Filtered Breather Kit | IDIFFBRE | | \$115.00 |
|---|----------|--|----------|

SUSPENSION TO SUIT RAM 1500 DT - 6/2018+

FRONT SUSPENSION

SHOCK ABSORBER

| | | | |
|-----------------------------------|---------|---|----------|
| Foam Cell Pro Strut - Performance | 45860FE | 2 | \$406.00 |
|-----------------------------------|---------|---|----------|

COIL SPRINGS

| | Est. Lift | Additional Load | | | |
|--------|-----------|-----------------|---------|---|----------|
| Light | 1.5" Lift | 0 - 50kg | RAM015A | 1 | \$262.00 |
| Medium | 2" Lift | 0 - 60kg | RAM015B | 1 | \$262.00 |
| Heavy | 2" Lift | 60 - 110kg | RAM015C | 1 | \$262.00 |

STRUT MOUNTS

| | | | |
|-----------------|---------|---|----------|
| Steel Strut Top | ISST075 | 2 | \$102.00 |
|-----------------|---------|---|----------|

CONTROL ARMS

| | | | |
|------------------------------|----------|---|----------|
| Pro-Forge Upper Control Arms | UCA075FA | 1 | \$882.00 |
|------------------------------|----------|---|----------|

REAR SUSPENSION

SHOCK ABSORBER

| | | | |
|-----------------------------|----------|---|----------|
| Foam Cell Pro - Comfort | 45862FEC | 2 | \$319.00 |
| Foam Cell Pro - Performance | 45862FE | 2 | \$319.00 |

COIL SPRINGS

| | Est. Lift | Additional Load | | | |
|--------|-----------|-----------------|---------|---|----------|
| Light | 1.5" Lift | 0 - 200kg | RAM016A | 1 | \$262.00 |
| Medium | 2" Lift | 0 - 300kg | RAM016B | 1 | \$262.00 |
| Heavy | 2" Lift | 200 - 500kg | RAM016C | 1 | \$262.00 |

SUSPENSION KIT - Specify Front Coil Springs When Ordering

| | | | |
|------------------------|-----------|-----------|-----------|
| Light - Foam Cell Pro | 1.5" Lift | RAM017AKP | \$1969.00 |
| Medium - Foam Cell Pro | 2" Lift | RAM017BKP | \$1969.00 |
| Heavy - Foam Cell Pro | 2" Lift | RAM017CKP | \$1969.00 |

SUSPENSION KIT CONTENTS

Shock Absorbers Coil Springs
Strut Shock Absorbers



DS
2014+

Product Description

Part No.

Qty
ReqRetail
ea Inc GST*Please check vehicle date range (if shown) next to product description prior to ordering***ACCESSORIES TO SUIT RAM 1500 DS - 2014+****STEEL WINCH BULL BARS**

Raid Full Length Steel Tubular Bumper

BBR075E

\$2064.00

** BBR075E suits vehicles with 4 parking sensor locations. Will not suit models with 6 parking sensor locations**• Raid Bull Bars are compatible with Ironman 4x4 Lightbars and Cube Lights, refer below for available options***LIGHTING OPTIONS - TO SUIT RAID BULL BARS**

300W Bright Sabre Dual Row Slim Lightbar 815mm (32") Straight

ILBDR002B

1

\$417.00

40W Bright Cube Spot Beam LED Cube Light - 81 x 75mm (Each) - Clear

ILED80B

2

\$83.00

40W Bright Cube Spot Beam LED Cube Light - 81 x 75mm (Each) - Amber

ILED80BA

2

\$83.00

40W Bright Cube Flood Beam LED Cube Light - 81 x 75mm (Each) - Clear

ILED80BF

2

\$83.00

40W Bright Cube Flood Beam LED Cube Light - 81 x 75mm (Each) - Amber

ILED80BFA

2

\$83.00

STEEL SIDE STEPS AND RAILS

Raid Side Steps*

SS075

\$1098.00

** Only compatible with Crew Cab model***REAR PROTECTION**

Raid Steel Rear Tubular Bumper - (US Only)

RTB075

-

Raid Steel Rear Tubular Bumper - (Australia Only)

RTB075AU

\$1620.00

LIGHTING OPTIONS - TO SUIT RAID REAR BARS

20W Bright Cube Spot Beam LED Cube Light - 70 x 64mm (Each) - Clear

ILED20B

2

\$62.00

20W Bright Cube Spot Beam LED Cube Light - 70 x 64mm (Each) - Amber

ILED20BA

2

\$62.00

20W Bright Cube Flood Beam LED Cube Light - 70 x 64mm (Each) - Clear

ILED20BF

2

\$62.00

20W Bright Cube Flood Beam LED Cube Light - 70 x 64mm (Each) - Amber

ILED20BFA

2

\$62.00

20W Bright Cube Flood Beam LED Cube Light - 70 x 64mm (Each) - Red

ILED20BFR

2

\$62.00

PREMIUM UNDERBODY PROTECTION

Ram 1500 DS

UBP075

\$745.00

SLIDE-AWAY ROLL UP HARD TONNEAU COVER

Electric with Remote Control (No RamBox) - Crew Cab Only with 5.8' Bed

ISLIDEAWAY075-E

\$2716.00

Electric with Remote Control (With RamBox) - Crew Cab Only with 5.8' Bed

ISLIDEAWAY075RB-E

\$2716.00

ATLAS RACK KIT

Platform S with Blade Fit Kit to Suit Slideaway Hard Tonneau Cover - 1390mm Length

IFRSLDAWAYPSK

\$1670.00

Crossbar (x 2) and Fit Kit to Suit Slideaway Hard Tonneau Cover - 1500mm Width

IFRSLDAWAYC2K

\$940.00

*• See Page 36 and 37 for more Atlas rack and crossbar options.***BREATHER KIT**

Universal Twin Manifold Filtered Breather Kit

IDIFFBRE

\$115.00

LISTING
CONTINUED
OVER THE
PAGE



Product Description

Part No.

Qty
Req

Retail
ea Inc GST

Please check vehicle date range (if shown) next to product description prior to ordering

SUSPENSION TO SUIT RAM 1500 DS - 2014+

FRONT SUSPENSION

SHOCK ABSORBER

| | | | | | |
|---|--|--|-------------------|---|----------|
| Foam Cell Pro Strut - Performance | | | 45855FE | 2 | \$406.00 |
| Foam Cell Pro Strut - Long Travel* (SEE NOTE) | | | 45855LFE * | 2 | \$406.00 |

*NOTE: MANDATORY FITMENT of UCA075FA and SBEXT075 is required with Long Travel - Foam Cell Pro Strut

COIL SPRINGS

| | Est. Lift | Additional Load | | | |
|--------|-----------|-----------------|----------------|---|----------|
| Light | 2" Lift | 0 - 50kg | RAM015A | 1 | \$262.00 |
| Medium | 2" Lift | 0 - 60kg | RAM015B | 1 | \$262.00 |
| Heavy | 2" Lift | 60 - 110kg | RAM015C | 1 | \$262.00 |

STRUT MOUNTS

| | | | | | |
|-----------------|--|--|----------------|---|----------|
| Steel Strut Top | | | ISST075 | 2 | \$102.00 |
|-----------------|--|--|----------------|---|----------|

SWAY BAR LINK

| | | | | | |
|--------------------------|--|--|-----------------|---|----------|
| Adjustable Sway Bar Link | | | SBEXT075 | 2 | \$149.00 |
|--------------------------|--|--|-----------------|---|----------|

CONTROL ARMS

| | | | | | |
|------------------------------|--|--|-----------------|---|----------|
| Pro-Forge Upper Control Arms | | | UCA075FA | 1 | \$882.00 |
|------------------------------|--|--|-----------------|---|----------|

REAR SUSPENSION

SHOCK ABSORBER

| | | | | | |
|---|--|--|--------------------|---|----------|
| Foam Cell Pro - Comfort | | | 45856FEC | 2 | \$319.00 |
| Foam Cell Pro - Comfort - Long Travel* (SEE NOTE) | | | 45856LFEC * | 2 | \$319.00 |
| Foam Cell Pro - Performance | | | 45856FE | 2 | \$319.00 |
| Foam Cell Pro - Performance - Long Travel* (SEE NOTE) | | | 45856LFE * | 2 | \$319.00 |

*NOTE: MANDATORY FITMENT of Ironman 4x4 Coil Springs are required with Long Travel - Foam Cell Pro

COIL SPRINGS

| | Est. Lift | Additional Load | | | |
|--------|-----------|-----------------|----------------|---|----------|
| Light | 1.5" Lift | 0 - 200kg | RAM016A | 1 | \$262.00 |
| Medium | 2" Lift | 0 - 300kg | RAM016B | 1 | \$262.00 |
| Heavy | 2" Lift | 200 - 500kg | RAM016C | 1 | \$262.00 |

SUSPENSION KIT - Specify Front Coil Springs When Ordering

| | | | |
|-------------------------|-----------|-------------------|-----------|
| Light - Foam Cell Pro | 1.5" Lift | RAM016AKP | \$2467.00 |
| Medium - Foam Cell Pro | 2" Lift | RAM016BKP | \$2467.00 |
| Medium - Foam Cell Pro* | 2.5" Lift | RAM016BKP1 | \$3480.00 |
| Heavy - Foam Cell Pro | 2" Lift | RAM016CKP | \$2467.00 |
| Heavy - Foam Cell Pro* | 2.5" Lift | RAM016CKP1 | \$3480.00 |

*Adjust 45855LFE seat height to 193mm

SUSPENSION KIT CONTENTS

| | | |
|-----------------------|--------------|---|
| Shock Absorbers | Coil Springs | Sway Bar Links |
| Strut Shock Absorbers | Strut Mounts | Upper Control Arms (2.5" lift kit only) |



Thai-Built Only
2017+

Renault Alaskan

| Product Description | Part No. | Qty Req | Retail ea Inc GST |
|---|----------------|------------|----------------------|
| <i>Please check vehicle date range (if shown) next to product description prior to ordering</i> | | | |
| ACCESSORIES TO SUIT RENAULT ALASKAN - 2017+ | | | |
| STEEL WINCH BULL BARS - THAI BUILT MODEL ONLY | | | |
| Commercial | BBC048 | | \$1723.00 |
| Commercial Deluxe | BBCD048 | | \$2345.00 |
| Polished Alloy | BBA048 | | \$2472.00 |
| Proguard No Loop | BBT048-NL | | \$1939.00 |
| Proguard Single Loop Kit | BB048-SL | | \$352.00 |
| Proguard Triple Loop Kit | BB048-TL | | \$423.00 |
| STEEL SIDE STEPS AND RAILS - FITS DUAL CAB MODELS ONLY | | | |
| Side Steps | SS048 | | \$1006.00 |
| Side Rails | SS048 RAIL | | \$332.00 |
| Side Steps and Rails | SSR048 | | \$1207.00 |
| TOWING | | | |
| Class 4 Towbar - Compatible with Factory Rear Bumper | TB048 | | \$608.00 |
| Rear Protection Towbar - Full Rear Bumper Replacement | RTB048 | | \$1388.00 |
| Rear Protection Towbar Plates (Pair) | RTBPLATE048 | | \$153.00 |
| Towbar Wiring Loom - Plug and Play | ITBL048 | | \$289.00 |
| LOCKSAFE DRAWER SYSTEMS | | | |
| Twin Drawers - 1300mm | ITD1300 | | \$1536.00 |
| Single Drawer - 1300mm | ISD1300 | | \$932.00 |
| Wing Kit - 1300mm* | ITDW048 | | \$367.00 |
| <i>*Designed to suit factory tubs, will not suit ute liner without modification.</i> | | | |
| LONG RANGE FUEL TANK | | | |
| 140L* - Auto/Coil Spring Diesel only. Not compatible with AdBlue equipped models | TANK048 | | \$1180.00 |
| <i>* Usable volume may differ to the stated tank capacity</i> | | | |
| PREMIUM UNDERBODY PROTECTION | | | |
| Engine Bay and Transmission - Series 1 | UBP048 | | \$782.00 |
| Engine Bay and Transmission - Series 2, 3 and 4 | UBP048S | | \$782.00 |
| CANOPY - ABS PLASTIC (SIDE LIFT UP WINDOWS AND CENTRAL LOCKING REAR DOOR) - FITS 4X4 AND 4X2 DUAL CAB MODELS | | | |
| White (QM1) | CANOPY013-PW | | \$3856.00 |
| Cosmic Black (G42) | CANOPY013-CB | | \$3856.00 |
| CANOPY - PINNACLE SMOOTH FINISH FIBREGLASS (SIDE LIFT UP WINDOWS AND CENTRAL LOCKING REAR DOOR) - FITS 4X4 AND 4X2 DUAL CAB MODELS | | | |
| White (QM1) | CANFIBRE048-PW | | \$3763.00 |
| Brilliant Silver (K23) | CANFIBRE048-BS | | \$3763.00 |
| White Diamond (QX1) | CANFIBRE048-WP | | \$3763.00 |
| Slate Grey (K21) | CANFIBRE048-SG | | \$3763.00 |
| <i>* Pre-primed canopies, plus colour coding.</i> | | | |
| BREATHER KIT | | | |
| Universal Twin Manifold Filtered Breather Kit | IDIFFBRE | | \$115.00 |

Renault Duster

2010+



Product Description

Part No.

Qty
Req

Retail
ea Inc GST

Please check vehicle date range (if shown) next to product description prior to ordering

SUSPENSION TO SUIT RENAULT DUSTER - 2010+

FRONT SUSPENSION

SHOCK ABSORBER

Nitro Gas Strut - Performance

12747GR

2

\$291.00

COIL SPRINGS

Medium

Est. Lift
40mm

Additional Load
0 - 50kg

REN001B

1

\$262.00

CAMBER CORRECTION

Camber Bolt Kit

ICAMBER12

1

\$30.00

REAR SUSPENSION

SHOCK ABSORBER

Nitro Gas Strut - Performance

12748GR

2

\$291.00

COIL SPRINGS

Medium

Est. Lift
40mm

Additional Load
0 - 200kg

REN002B

1

\$262.00

CAMBER CORRECTION

Camber Bolt Kit

ICAMBER12

1

\$30.00

SUSPENSION KIT

Medium - Nitro Gas

REN001BKG

\$1738.00

SUSPENSION KIT CONTENTS

Shock Absorbers

Camber Correction

Coil Springs



Q200 / Q201 / Q205 / Q215
10/2018+

SsangYong Musso

Product Description

Part No.

Qty
Req

Retail
ea Inc GST

Please check vehicle date range (if shown) next to product description prior to ordering

ACCESSORIES TO SUIT SSANGYONG MUSSO - 10/2018+

STEEL WINCH BULL BARS

Commercial Deluxe (Not suitable for Q215 Model)

BBCD071

\$2345.00

• Winch with Steel Cable and Roller Fairlead is not suitable - Use Winch with Synthetic Rope and Alloy Hawse only

PREMIUM UNDERBODY PROTECTION

Engine Bay

UBP201SY

\$550.00

SLIDE-AWAY ROLL UP HARD TONNEAU COVER

Electric with Remote Control

ISLIDEAWAY071-E

\$2716.00

ATLAS ROOF RACK KITS

Platform S with Blade Fit Kit to Suit Slideaway Hard Tonneau Cover - 1390mm Length

IFRSLDAWAYPSK

\$1670.00

Crossbar (x 2) and Fit Kit to Suit Slideaway Hard Tonneau Cover - 1500mm Width

IFRSLDAWAYC2K

\$940.00

• See Page 36 and 37 for more Atlas rack and crossbar options.

BREATHER KIT

Universal Twin Manifold Filtered Breather Kit

IDIFFBRE

\$115.00

LISTING
CONTINUED
OVER THE
PAGE



SsangYong Musso

Q200 SWB
10/2018+



Product Description

Part No.

Qty
Req

Retail
ea Inc GST

Please check vehicle date range (if shown) next to product description prior to ordering

SUSPENSION TO SUIT SSANGYONG MUSSO Q200 - 10/2018+

FRONT SUSPENSION

SHOCK ABSORBER

Nitro Gas Strut - Performance

12823GR 2 \$232.00

COIL SPRINGS

| | Est. Lift | Additional Load | | | |
|--------|-----------|-----------------|------------------|---|----------|
| Medium | 30mm | 0-50kg | SSANG003B | 1 | \$262.00 |
| Heavy | 35mm | 50-100kg | SSANG003C | 1 | \$262.00 |

• Estimated lift is 15mm less in 2020+ models due to factory OEM height increase

REAR SUSPENSION

SHOCK ABSORBER

Nitro Gas - Performance

12824GR 2 \$160.00

COIL SPRINGS

| | Est. Lift | Additional Load | | | |
|--------|-----------|-----------------|------------------|---|----------|
| Medium | 35mm | 0 - 200kg | SSANG004B | 1 | \$262.00 |
| Heavy | 40mm | 200 - 400kg | SSANG004C | 1 | \$262.00 |

• Estimated lift is 15mm less in 2020+ models due to factory OEM height increase

SUSPENSION KIT - Specify Front Coil Springs When Ordering

| | | |
|--------------------|--------------------|-----------|
| Medium - Nitro Gas | SSANG004BKG | \$1304.00 |
| Heavy - Nitro Gas | SSANG004CKG | \$1304.00 |

• Estimated lift is 15mm less in 2020+ models due to factory OEM height increase

SUSPENSION KIT CONTENTS

| | |
|-----------------------|--------------|
| Shock Absorbers | Coil Springs |
| Strut Shock Absorbers | |



Q201 / Q215 LWB (Coil)
10/2018+

SsangYong Musso

Product Description

Part No.

Qty
ReqRetail
ea Inc GST

Please check vehicle date range (if shown) next to product description prior to ordering

SUSPENSION TO SUIT SSANGYONG MUSSO Q201 / Q215 - 10/2018+

FRONT SUSPENSION

SHOCK ABSORBER

Nitro Gas Strut - Performance

12823GR

2

\$232.00

COIL SPRINGS

| | Est. Lift | Additional Load | Part No. | Qty | Price |
|--------|-----------|-----------------|-----------|-----|----------|
| Medium | 30mm | 0 - 50kg | SSANG003B | 1 | \$262.00 |
| Heavy | 35mm | 50 - 100kg | SSANG003C | 1 | \$262.00 |

• Estimated lift is 15mm less in 2020+ models due to factory OEM height increase

REAR SUSPENSION

SHOCK ABSORBER

Nitro Gas - Performance

12825GR

2

\$160.00

COIL SPRINGS

| | Est. Lift | Additional Load | Part No. | Qty | Price |
|--------|-----------|-----------------|-----------|-----|----------|
| Medium | 35mm | 0 - 200kg | SSANG006B | 1 | \$262.00 |
| Heavy | 40mm | 200 - 400kg | SSANG006C | 1 | \$262.00 |

• Estimated lift is 15mm less in 2020+ models due to factory OEM height increase

SUSPENSION KIT - Specify Front Coil Springs When Ordering

Medium - Nitro Gas

SSANG006BKG

\$1186.00

Heavy - Nitro Gas

SSANG006CKG

\$1186.00

• Estimated lift is 15mm less in 2020+ models due to factory OEM height increase

SUSPENSION KIT CONTENTS

Shock Absorbers

Coil Springs

Strut Shock Absorbers

SsangYong Musso

Q201 / Q205 / Q215 LWB (Leaf)
10/2018+



Product Description

Part No.

Qty
Req

Retail
ea Inc GST

Please check vehicle date range (if shown) next to product description prior to ordering

SUSPENSION TO SUIT SSANGYONG MUSSO Q201 / Q205 / Q215 - 10/2018+

FRONT SUSPENSION

SHOCK ABSORBER

| | | | | | |
|-------------------------------|--|--|----------------|---|----------|
| Nitro Gas Strut - Performance | | | 12823GR | 2 | \$232.00 |
|-------------------------------|--|--|----------------|---|----------|

COIL SPRINGS

| | Est. Lift | Additional Load | | | |
|--------|-----------|-----------------|------------------|---|----------|
| Medium | 30mm | 0-50kg | SSANG003B | 1 | \$262.00 |
| Heavy | 35mm | 50-100kg | SSANG003C | 1 | \$262.00 |

• Estimated lift is 15mm less in 2020+ models due to factory OEM height increase

REAR SUSPENSION

SHOCK ABSORBER

| | | | | | |
|-------------------------|--|--|----------------|---|----------|
| Nitro Gas - Performance | | | 12826GR | 2 | \$160.00 |
|-------------------------|--|--|----------------|---|----------|

LEAF SPRINGS

| | Est. Lift | Additional Load | | | |
|--------|-----------|-----------------|------------------|---|----------|
| Medium | 45mm | 0-300kg | SSANG005B | 2 | \$392.00 |
| Heavy | 50mm | 300kg-GVM | SSANG005C | 2 | \$421.00 |

U-BOLTS

| | | | | | |
|------------|--|--|----------------|---|---------|
| U-Bolt Kit | | | 1105UBK | 2 | \$44.00 |
|------------|--|--|----------------|---|---------|

POLYURETHANE SPRING BUSHES

| | | | | | |
|----------|--|--|---------------|---|----------|
| Bush Kit | | | 1153UK | 1 | \$175.00 |
|----------|--|--|---------------|---|----------|

SUSPENSION KIT - Specify Front Coil Springs When Ordering

| | | |
|--------------------|--------------------|-----------|
| Medium - Nitro Gas | SSANG005BKG | \$1517.00 |
| Heavy - Nitro Gas | SSANG005CKG | \$1559.00 |

SUSPENSION KIT CONTENTS

| | | |
|-----------------------|--------------|----------------------------|
| Shock Absorbers | Coil Springs | U-Bolts |
| Strut Shock Absorbers | Leaf Springs | Polyurethane Spring Bushes |



1996 to 2006

SUSPENSION TO SUIT SsangYong Musso / Korando

Product Description

Part No.

Qty
Req

Retail
ea Inc GST

Please check vehicle date range (if shown) next to product description prior to ordering

SUSPENSION TO SUIT SSANGYONG MUSSO / KORANDO - 1996-2006

FRONT SUSPENSION

SHOCK ABSORBER

| | | | |
|-------------------------|----------------|---|----------|
| Nitro Gas - Performance | 12667GR | 2 | \$160.00 |
| Foam Cell - Performance | 24667FE | 2 | \$232.00 |

TORSION BAR

| | | | |
|----------------------|-----------------|---|----------|
| Uprated Torsion Bars | SSANG001 | 1 | \$609.00 |
|----------------------|-----------------|---|----------|

• Minimum 60mm downward suspension travel required after adjustment

REAR SUSPENSION

SHOCK ABSORBER

| | | | |
|-------------------------|-----------------|---|----------|
| Nitro Gas - Performance | 12661GRS | 2 | \$160.00 |
| Foam Cell - Performance | 24661FES | 2 | \$232.00 |

COIL SPRINGS

| | Est. Lift | Additional Load | | |
|--------|-----------|-----------------|------------------|---|
| Medium | 45mm | 0 -200kg | SSANG002B | 1 |

SUSPENSION KIT

| | | |
|--------------------|--------------------|-----------|
| Medium - Nitro Gas | SSANG002BKG | \$1506.00 |
| Medium - Foam Cell | SSANG002BKF | \$1796.00 |

SUSPENSION KIT CONTENTS

Shock Absorbers Torsion Bars
Coil Springs

SsangYong Rexton

Y400
10/2018+



Product Description

Part No.

Qty
Req

Retail
ea Inc GST

Please check vehicle date range (if shown) next to product description prior to ordering

ACCESSORIES TO SUIT SSANGYONG REXTON Y400 - 10/2018+

STEEL WINCH BULL BARS

Commercial Deluxe

BBCD071

\$2345.00

• Winch with Steel Cable and Roller Fairlead is not suitable - Use Winch with Synthetic Rope and Alloy Hawse only

PREMIUM UNDERBODY PROTECTION

Engine Bay

UBP201SY

\$550.00

BREATHER KIT

Universal Twin Manifold Filtered Breather Kit

IDIFFBRE

\$115.00



Y400 / Y450
2018+

SsangYong Rexton

Product Description

Part No.

Qty
ReqRetail
ea Inc GST

Please check vehicle date range (if shown) next to product description prior to ordering

SUSPENSION TO SUIT SSANGYONG REXTON Y400 / Y450 - 10/2018+

FRONT SUSPENSION

SHOCK ABSORBER

Nitro Gas - Performance

12823GR

2

\$232.00

COIL SPRINGS

Est. Lift

Additional Load

Medium

30mm

0-50kg

SSANG003B

1

\$262.00

Heavy

35mm

50-100kg

SSANG003C

1

\$262.00

REAR SUSPENSION

SHOCK ABSORBER

Nitro Gas - Performance

12828GR

2

\$160.00

COIL SPRINGS

Est. Lift

Additional Load

Medium

40mm

0-200kg

SSANG010B

1

\$262.00

SUSPENSION KIT - Specify Front Coil Springs When Ordering

Medium - Nitro Gas

SSANG010BKG

\$1304.00

SUSPENSION KIT CONTENTS

Shock Absorbers

Coil Springs

Strut Shock Absorbers

Subaru Forester

2019+



Product Description

Part No.

Qty
Req

Retail
ea Inc GST

Please check vehicle date range (if shown) next to product description prior to ordering

SUSPENSION TO SUIT SUBARU FORESTER - 2019+

FRONT SUSPENSION

SHOCK ABSORBER

| | Est. Lift | Additional Load | | | |
|---|-----------|-----------------|----------------------|---|----------|
| Nitro Gas Strut Assembly Left - Medium | 50mm | 0 - 50kg | 12830007GRLH | 1 | \$493.00 |
| Nitro Gas Strut Assembly Right - Medium | 50mm | 0 - 50kg | 12830007GRRH | 1 | \$493.00 |
| Nitro Gas Strut Assembly Left - Heavy | 50mm | 50 - 80kg | 12830007GRPLH | 1 | \$493.00 |
| Nitro Gas Strut Assembly Right - Heavy | 50mm | 50 - 80kg | 12830007GRPRH | 1 | \$493.00 |

• *Strut Assembly includes pre-assembled Coil Springs, Shock Absorber and Strut Top Cap*

REAR SUSPENSION

SHOCK ABSORBER

| | Est. Lift | Additional Load | | | |
|-----------------------------------|-----------|-----------------|--------------------|---|----------|
| Nitro Gas Strut Assembly - Medium | 50mm | 0 - 200kg | 12832008GR | 2 | \$480.00 |
| Nitro Gas Strut Assembly - Heavy | 50mm | 200kg - GVM | 12832008GRP | 2 | \$480.00 |

• *Strut Assembly includes pre-assembled Coil Springs, Shock Absorber and Strut Top Cap*

SPACER KIT

| | | | | | |
|-------------------------|--|--|--------------|---|----------|
| Sway Bar Relocation Kit | | | 1216K | 1 | \$122.00 |
| Sub Frame Alignment Kit | | | 1215K | 1 | \$309.00 |

SUSPENSION KIT

| | | | | | |
|--------------------|--|--|------------------|--|-----------|
| Medium - Nitro Gas | | | SUB007BKG | | \$2372.00 |
| Heavy - Nitro Gas | | | SUB007CKG | | \$2372.00 |

SUSPENSION KIT CONTENTS

| | |
|-------------------------------------|-----------------------------|
| Left / Right Front Strut Assemblies | Rear Subframe Alignment Kit |
| Rear Strut Assemblies | Sway Bar Relocation Kit |



SF5, GX, RX, GT
1997 to 2013

Subaru Forester

Product Description

Part No.

Qty
Req

Retail
ea Inc GST

Please check vehicle date range (if shown) next to product description prior to ordering

SUSPENSION TO SUIT SUBARU FORESTER SF5, GX, RX, GT - 1997-2013

FRONT SUSPENSION

COIL SPRINGS

| | Est. Lift | Additional Load | | | |
|----------------------|-----------|-----------------|----------------|---|----------|
| Medium - 1997 - 2001 | 35mm | 0 - 50kg | SUB001B | 1 | \$262.00 |
| Medium - 2002 - 2008 | 35mm | 0 - 50kg | SUB003B | 1 | \$262.00 |
| Medium - 2008 - 2013 | 20mm | 0 - 50kg | SUB005B | 1 | \$262.00 |

CAMBER CORRECTION

| | | | | | |
|-----------------|--|--|------------------|---|---------|
| Camber Bolt Kit | | | ICAMBER14 | 1 | \$30.00 |
|-----------------|--|--|------------------|---|---------|

REAR SUSPENSION

COIL SPRINGS

| | Est. Lift | Additional Load | | | |
|----------------------|-----------|-----------------|----------------|---|----------|
| Medium - 1997 - 2001 | 35mm | 0 - 200kg | SUB002B | 1 | \$262.00 |
| Medium - 2002 - 2008 | 35mm | 0 - 200kg | SUB004B | 1 | \$262.00 |
| Medium - 2008 - 2013 | 20mm | 0 - 200kg | SUB006B | 1 | \$262.00 |

• Not suitable for self leveling suspension models

CAMBER CORRECTION

| | | | | | |
|-----------------|--|--|------------------|---|---------|
| Camber Bolt Kit | | | ICAMBER14 | 1 | \$30.00 |
|-----------------|--|--|------------------|---|---------|

Subaru Outback

2015 to 2019
2020+



Product Description

Part No.

Qty
Req

Retail
ea Inc GST

Please check vehicle date range (if shown) next to product description prior to ordering

SUSPENSION TO SUIT SUBARU OUTBACK - 2015+

FRONT SUSPENSION

SHOCK ABSORBER

| | Est. Lift | Additional Load | | | |
|--|-----------|-----------------|----------------------|---|----------|
| Nitro Gas Strut Assembly Left - Medium (2015-2019) | 50mm | 0 - 50kg | 12833009GRLH | 1 | \$493.00 |
| Nitro Gas Strut Assembly Right- Medium (2015-2019) | 50mm | 0 - 50kg | 12833009GRRH | 1 | \$493.00 |
| Nitro Gas Strut Assembly Left - Heavy (2015-2019) | 50mm | 50 - 80kg | 12833009GRPLH | 1 | \$493.00 |
| Nitro Gas Strut Assembly Right- Heavy (2015-2019) | 50mm | 50 - 80kg | 12833009GRPRH | 1 | \$493.00 |
| Nitro Gas Strut Assembly Left - Medium (2020+) | 50mm | 0 - 50kg | 12831009GRLH | 1 | \$493.00 |
| Nitro Gas Strut Assembly Right- Medium (2020+) | 50mm | 0 - 50kg | 12831009GRRH | 1 | \$493.00 |
| Nitro Gas Strut Assembly Left - Heavy (2020+) | 50mm | 50 - 80kg | 12831009GRPLH | 1 | \$493.00 |
| Nitro Gas Strut Assembly Right- Heavy (2020+) | 50mm | 50 - 80kg | 12831009GRPRH | 1 | \$493.00 |

- Strut Assembly includes pre-assembled Coil Springs, Shock Absorber and Strut Top Cap
- Gen 5 (2015-2019) uses 10mm Strut Top Studs - Gen 6 (2020+) uses 12mm Strut Top Studs

REAR SUSPENSION

SHOCK ABSORBER

| | Est. Lift | Additional Load | | | |
|---|-----------|-----------------|--------------------|---|----------|
| Nitro Gas Strut Assembly - Medium (2015-2019) | 50mm | 0 - 200kg | 12834010GR | 2 | \$480.00 |
| Nitro Gas Strut Assembly - Heavy (2015-2019) | 50mm | 200kg - GVM | 12834010GRP | 2 | \$480.00 |
| Nitro Gas Strut Assembly - Medium (2020+) | 50mm | 0 - 200kg | 12834014GR | 2 | \$480.00 |
| Nitro Gas Strut Assembly - Heavy (2020+) | 50mm | 200kg - GVM | 12834014GRP | 2 | \$480.00 |

- Strut Assembly includes pre-assembled Coil Springs, Shock Absorber and Strut Top Cap

SPACER KIT

| | | | | |
|-------------------------|--|--------------|---|----------|
| Sub Frame Alignment Kit | | 1215K | 1 | \$309.00 |
|-------------------------|--|--------------|---|----------|

SUSPENSION KIT

| | | |
|--------------------------------|-------------------|-----------|
| Medium - Nitro Gas (2015-2019) | SUB009BKG | \$2251.00 |
| Heavy - Nitro Gas (2015-2019) | SUB009CKG | \$2251.00 |
| Medium - Nitro Gas (2020+) | SUB009BKG1 | \$2251.00 |
| Heavy - Nitro Gas (2020+) | SUB009CKG1 | \$2251.00 |

SUSPENSION KIT CONTENTS

Left / Right Front Strut Assemblies Rear Subframe Alignment Kit
Rear Strut Assemblies



2018+

Subaru XV Crosstrek

Product Description

Part No.

Qty
ReqRetail
ea Inc GST

Please check vehicle date range (if shown) next to product description prior to ordering

SUSPENSION TO SUIT SUBARU XV CROSSTREK - 2018+

FRONT SUSPENSION

| SHOCK ABSORBER | Est. Lift | Additional Load | Part No. | Qty | Retail Price |
|--|-----------|-----------------|---------------|-----|--------------|
| Nitro Gas Strut Assembly Left - Medium | 50mm | 0 - 50kg | 12835011GRLH | 1 | \$493.00 |
| Nitro Gas Strut Assembly Right- Medium | 50mm | 0 - 50kg | 12835011GRRH | 1 | \$493.00 |
| Nitro Gas Strut Assembly Left - Heavy | 50mm | 50 - 80kg | 12835011GRPLH | 1 | \$493.00 |
| Nitro Gas Strut Assembly Right- Heavy | 50mm | 50 - 80kg | 12835011GRPRH | 1 | \$493.00 |

• Strut Assembly includes pre-assembled Coil Springs, Shock Absorber and Strut Top Cap

REAR SUSPENSION

| SHOCK ABSORBER | Est. Lift | Additional Load | Part No. | Qty | Retail Price |
|-----------------------------------|-----------|-----------------|-------------|-----|--------------|
| Nitro Gas Strut Assembly - Medium | 50mm | 0 - 200kg | 12836012GR | 2 | \$480.00 |
| Nitro Gas Strut Assembly - Heavy | 50mm | 200kg - GVM | 12836012GRP | 2 | \$480.00 |

• Strut Assembly includes pre-assembled Coil Springs, Shock Absorber and Strut Top Cap

SPACER KIT

| | | | |
|-------------------------|-------|---|----------|
| Sway Bar Relocation Kit | 1216K | 1 | \$122.00 |
| Sub Frame Alignment Kit | 1215K | 1 | \$309.00 |

SUSPENSION KIT

| | | |
|--------------------|-----------|-----------|
| Medium - Nitro Gas | SUB011BKG | \$2418.00 |
| Heavy - Nitro Gas | SUB011CKG | \$2418.00 |

SUSPENSION KIT CONTENTS

| | | |
|-------------------------------------|-----------------------------|------------------------|
| Left / Right Front Strut Assemblies | Rear Subframe Alignment Kit | Exhaust Hanger Rubbers |
| Rear Strut Assemblies | Sway Bar Relocation Kit | |



Product Description

Part No.

Qty
Req

Retail
ea Inc GST

Please check vehicle date range (if shown) next to product description prior to ordering

ACCESSORIES TO SUIT SUZUKI JIMNY GJ - 2018+

STEEL WINCH BULL BARS

| | | |
|-------------------------------------|---------|-----------|
| Commercial Deluxe* | BBCD070 | \$1825.00 |
| Jimny Special* | BBS070 | \$1825.00 |
| Driving Light / Lightbar Patch Loom | IPL070 | \$33.00 |

- Winch with Steel Cable and Roller Fairlead is not suitable - Use Winch with Synthetic Rope and Alloy Hawse only
- Uses factory fog/DRL Lights. Suits factory flares

* Black textured paint

RECOVERY POINTS - IRONMAN 4X4 BULL BAR ONLY

| | | |
|--|--------|----------|
| Recovery Points - 5000kg Rating (Pair) | IRP070 | \$300.00 |
|--|--------|----------|

ALLOY ROOF RACKS

| | | |
|---------------------------------------|-----------------|-----------|
| Cage Style - 1.4m x 1.25m | IRRCAGE14-ALLOY | \$1028.00 |
| Trade Style - 1.4m x 1.25m (Open end) | IRROPEN14-ALLOY | \$1015.00 |

STEEL AND ALLOY ROOF RACK - MOUNT KITS

| | | |
|------------------------------------|------------|----------|
| Gutter Mount Feet - 100mm (8 Feet) | IRRFEET100 | \$207.00 |
|------------------------------------|------------|----------|

PREMIUM UNDERBODY PROTECTION

| | | |
|--------------------------------------|--------|----------|
| Transfer Case, Driveline and Exhaust | UBP070 | \$550.00 |
|--------------------------------------|--------|----------|

SNORKEL

| | | |
|-------|-------------|----------|
| 2018+ | ISNORKEL070 | \$437.00 |
|-------|-------------|----------|

ATLAS ROOF RACK KIT

| | | |
|---|-----------|----------|
| Crossbar (x 2) and Fit Kit - 1500mm Width | IFR070C2K | \$523.00 |
|---|-----------|----------|

- See Page 36 and 37 for more Atlas rack and crossbar options.

SEAT COVER

| | | |
|------------------------|----------|----------|
| Canvas Comfort - Front | ICSC070F | \$420.00 |
| Canvas Comfort - Rear | ICSC070R | \$420.00 |

BREATHER KIT

| | | |
|---|----------|----------|
| Universal Twin Manifold Filtered Breather Kit | IDIFFBRE | \$115.00 |
|---|----------|----------|



GJ
2018+

Product Description

Part No.

Qty
ReqRetail
ea Inc GST*Please check vehicle date range (if shown) next to product description prior to ordering***SUSPENSION TO SUIT SUZUKI JIMNY GJ - 2018+****FRONT SUSPENSION****SHOCK ABSORBER**Nitro Gas - Performance **12759GR** 2 \$160.00**STEERING DAMPER**Foam Cell **3542** 1 \$175.00**COIL SPRINGS**

| | Est. Lift | Additional Load | | | |
|--------|-----------|-----------------|----------------|---|----------|
| Medium | 50mm | 0 - 50kg | SUZ009B | 1 | \$262.00 |
| Heavy | 50mm | 50 - 80kg | SUZ009C | 1 | \$262.00 |

CHASSIS DROPMEMBERFront Crossmember Drop Brackets **IDM009** 1 \$146.00**OFFSET CASTER BUSH KIT**Offset Bush Kit Rubber 2 Degree offset **1146RK** 1 \$131.00**BUMP STOP**Extended Bump Stop **1219R** 2 \$41.00

• Must install 1219R extended bump stop when fitting 1146RK

• Must install IDM009 Dropmember when fitting 1146RK and 12759GR

REAR SUSPENSION**SHOCK ABSORBER**Nitro Gas - Performance **12760GR** 2 \$160.00**COIL SPRINGS**

| | Est. Lift | Additional Load | | | |
|--------------|-----------|-----------------|----------------|---|----------|
| Medium - RHD | 50mm | 0 - 200kg | SUZ010B | 1 | \$262.00 |
| Medium - LHD | 50mm | 0 - 200kg | SUZ011B | 1 | \$262.00 |
| Heavy - RHD | 50mm | 200 - 400kg | SUZ010C | 1 | \$262.00 |
| Heavy - LHD | 50mm | 200 - 400kg | SUZ011C | 1 | \$262.00 |

• SUZ010 are staggered height for Japan Spec vehicles, SUZ011 are equal height for Euro spec vehicles

BRAKE HOSEExtended Brake Hose Left side **BHOSE009** 1 \$74.00**SPACER KIT**Extended Headlight Sensor Bracket **1211K** 1 \$15.00

• Must install BHOSE009 and 1211K when fitting 12760GR

SUSPENSION KIT - Specify Front Coil Springs When OrderingMedium - Nitro Gas **SUZ010BKG** \$1390.00Heavy - Nitro Gas **SUZ010CKG** \$1390.00**SUSPENSION KIT CONTENTS**

Shock Absorbers

Extended Brake Hose

Front Crossmember Drop Brackets

Coil Springs

Extended Headlight Sensor Bracket

**OPTIONS AVAILABLE FOR THIS VEHICLE - SEE PAGE 384**



Product Description

Part No.

Qty
Req

Retail
ea Inc GST

Please check vehicle date range (if shown) next to product description prior to ordering

ACCESSORIES TO SUIT SUZUKI JIMNY - 2012-1/2019

STEEL WINCH BULL BARS

Commercial Deluxe

BBCD063

\$2345.00

• Winch with Steel Cable and Roller Fairlead is not suitable - Use Winch with Synthetic Rope and Alloy Hawse only

BREATHER KIT

Universal Twin Manifold Filtered Breather Kit

IDIFFBRE

\$115.00

Suzuki Jimny

SN413
1998 to 2018

Product Description

Part No.

Qty
ReqRetail
ea Inc GST*Please check vehicle date range (if shown) next to product description prior to ordering***SUSPENSION TO SUIT SUZUKI JIMNY SN413 - 1998-2018****FRONT SUSPENSION****SHOCK ABSORBER**Nitro Gas - Performance **12759GR** 2 \$160.00**STEERING DAMPER**Foam Cell Includes Adaptor Kit **3521S** 1 \$175.00**COIL SPRINGS**Medium Est. Lift Additional Load **SUZ009B** 1 \$262.00**OFFSET CASTER BUSH KIT**Offset Bush Kit Rubber 2 Degree offset **1146RK** 1 \$131.00**REAR SUSPENSION****SHOCK ABSORBER**Nitro Gas - Performance **12760GR** 2 \$160.00**COIL SPRINGS**Medium - Japan Spec Est. Lift Additional Load **SUZ010B** 1 \$262.00Medium - Euro Spec **SUZ011B** 1 \$262.00

• SUZ010B are staggered height for Japan Spec vehicles, SUZ011B are equal height for Euro spec vehicles

SUSPENSION KITMedium - Nitro Gas **SUZ009BKG** \$1159.00

• Specify rear Coil Springs when ordering

SUSPENSION KIT CONTENTS

Shock Absorbers

Coil Springs

Suzuki Sierra

SJ80 (Coil)
1997+



Product Description

Part No.

Qty
Req

Retail
ea Inc GST

Please check vehicle date range (if shown) next to product description prior to ordering

SUSPENSION TO SUIT SUZUKI SIERRA SJ80 - 1997+

FRONT SUSPENSION

COIL SPRINGS

| | Est. Lift | Additional Load | Part No. | Qty Req | Retail Price |
|--------|-----------|-----------------|----------|---------|--------------|
| Medium | 35mm | 0 -40kg | SUZ007B | 1 | \$262.00 |

OFFSET CASTER BUSH KIT

| | | | | | |
|------------------------|-----------------|--|--------|---|----------|
| Offset Bush Kit Rubber | 2 Degree offset | | 1146RK | 1 | \$131.00 |
|------------------------|-----------------|--|--------|---|----------|

REAR SUSPENSION

COIL SPRINGS

| | Est. Lift | Additional Load | Part No. | Qty Req | Retail Price |
|--------|-----------|-----------------|----------|---------|--------------|
| Medium | 35mm | 0 -200kg | SUZ008B | 1 | \$262.00 |



Suzuki Sierra



Samurai LJ, SJ (Leaf)
1981+

Product Description

Part No.

Qty
ReqRetail
ea Inc GST

Please check vehicle date range (if shown) next to product description prior to ordering

SUSPENSION TO SUIT SUZUKI SIERRA SAMURAI LJ, SJ - 1981+

FRONT SUSPENSION

SHOCK ABSORBER

| | | | | | |
|-------------------------|--|--|----------------|---|----------|
| Nitro Gas - Performance | | | 12085GR | 2 | \$160.00 |
|-------------------------|--|--|----------------|---|----------|

LEAF SPRINGS

| | Est. Lift | Additional Load | | | |
|-----------------------|-----------|-----------------|-------------------|---|----------|
| Medium - Drivers Side | 50mm | 0 - 50kg | SUZ001BD/S | 1 | \$218.00 |
| Medium - Near Side | 50mm | 0 - 50kg | SUZ001BN/S | 1 | \$218.00 |

STEERING DAMPER

| | | | | | |
|-----------|--|--|-------------|---|----------|
| Foam Cell | | | 3530 | 1 | \$175.00 |
|-----------|--|--|-------------|---|----------|

U-BOLTS

| | | | | | |
|------------|--|--------------|---------------|---|---------|
| U-Bolt Kit | | Drivers side | 654UBK | 1 | \$44.00 |
| U-Bolt Kit | | Near side | 655UBK | 1 | \$44.00 |

POLYURETHANE SPRING BUSHES

| | | | | | |
|----------|--|--|--------------|---|---------|
| Bush Kit | | | 734UK | 1 | \$88.00 |
|----------|--|--|--------------|---|---------|

REAR SUSPENSION

SHOCK ABSORBER

| | | | | | |
|-------------------------|--|--|----------------|---|----------|
| Nitro Gas - Performance | | | 12086GR | 2 | \$160.00 |
|-------------------------|--|--|----------------|---|----------|

LEAF SPRINGS

| | Est. Lift | Additional Load | | | |
|-------------------------|-----------|-----------------|-------------------|---|----------|
| Medium | 50mm | 0 - 200kg | SUZ002B | 2 | \$262.00 |
| Medium - Optional +20mm | 50mm | 0 - 200kg | SUZ002BD/S | 1 | \$262.00 |

• Optional D/S spring to offset uneven weight distribution, eg. Spare Wheel

U-BOLTS

| | | | | | |
|------------|--|--|---------------|---|---------|
| U-Bolt Kit | | | 655UBK | 2 | \$44.00 |
|------------|--|--|---------------|---|---------|

POLYURETHANE SPRING BUSHES

| | | | | | |
|----------|--|--|--------------|---|---------|
| Bush Kit | | | 734UK | 1 | \$88.00 |
|----------|--|--|--------------|---|---------|

HELPER SPRINGS

| | | | | | |
|--------------------------|--|--|------------|---|----------|
| Load Plus Helper Springs | | | LP5 | 1 | \$165.00 |
|--------------------------|--|--|------------|---|----------|

SUSPENSION KIT - Specify Rear Spring When Ordering

| | | | | | |
|--------------------|--|--|------------------|--|-----------|
| Medium - Nitro Gas | | | SUZ001BKG | | \$1941.00 |
|--------------------|--|--|------------------|--|-----------|

SUSPENSION KIT CONTENTS

Shock Absorbers

U-Bolts

Leaf Springs

Polyurethane Spring Bushes

Suzuki Grand Vitara

8/2005 to 2015



Product Description

Part No.

Qty
Req

Retail
ea Inc GST

Please check vehicle date range (if shown) next to product description prior to ordering

ACCESSORIES TO SUIT SUZUKI GRAND VITARA - 8/2005-2015

STEEL WINCH BULL BARS - 2012 DIESEL MANUAL ONLY - NOT COMPATIBLE WITH V6 MODEL

Commercial Deluxe - Diesel Manual Only

BBCD046

\$2345.00

Protector - Diesel Manual Only - *While Stocks Last*

BBT046

\$2271.00

BREATHER KIT

Universal Twin Manifold Filtered Breather Kit

IDIFFBRE

\$115.00



8/2005 to 2015

Suzuki Grand Vitara

Product Description

Part No.

Qty
Req

Retail
ea Inc GST

Please check vehicle date range (if shown) next to product description prior to ordering

SUSPENSION TO SUIT SUZUKI GRAND VITARA - 8/2005-2015

FRONT SUSPENSION

SHOCK ABSORBER

| | | | | |
|-------------------------------|-----------------|----------------|---|----------|
| Nitro Gas Strut - Performance | McPherson Strut | 12721GR | 2 | \$262.00 |
|-------------------------------|-----------------|----------------|---|----------|

COIL SPRINGS

| | Est. Lift | Additional Load | | |
|--------------------------|-----------|-----------------|----------------|---|
| Medium | 40mm | 0 - 50kg | SUZ019B | 1 |
| Heavy or Diesel, or 2.7L | 40mm | 50 - 100kg | SUZ019C | 1 |

CAMBER CORRECTION

| | | | |
|-----------------|------------------|---|---------|
| Camber Bolt Kit | ICAMBER14 | 1 | \$30.00 |
|-----------------|------------------|---|---------|

REAR SUSPENSION

SHOCK ABSORBER

| | | | |
|-------------------------|----------------|---|----------|
| Nitro Gas - Performance | 12722GR | 2 | \$160.00 |
|-------------------------|----------------|---|----------|

COIL SPRINGS

| | Est. Lift | Additional Load | | |
|--------------------|-----------|-----------------|----------------|---|
| Medium - SWB (GV3) | 40mm | 0 - 200kg | SUZ020A | 1 |
| Medium - LWB | 40mm | 0 - 200kg | SUZ020B | 1 |
| Heavy - LWB | 40mm | 200 - 400kg | SUZ020C | 1 |

SUSPENSION KIT - Specify Front Coil Springs When Ordering

| | | | |
|--------------------|---------|------------------|-----------|
| Medium - Nitro Gas | SWB GV3 | SUZ019AKG | \$1390.00 |
| Medium - Nitro Gas | LWB | SUZ019BKG | \$1390.00 |
| Heavy - Nitro Gas | LWB | SUZ019CKG | \$1390.00 |

• SWB refers 3 door vehicles, LWB refers 5 door vehicles

• Monocoque constructed vehicles such as Suzuki Grand Vitara can be subject to increased NVH (Noise) with upgraded suspension installed

SUSPENSION KIT CONTENTS

Shock Absorbers
Coil Springs

Strut Shock Absorbers
Camber Correction



Suzuki Grand Vitara

1988 to 7/2005



Product Description

Part No.

Qty
Req

Retail
ea Inc GST

Please check vehicle date range (if shown) next to product description prior to ordering

SUSPENSION TO SUIT SUZUKI GRAND VITARA - 1988-7/2005

FRONT SUSPENSION

SHOCK ABSORBER

| | | | | |
|-------------------------------|------------------------|----------------|---|----------|
| Nitro Gas Strut - Performance | Full replacement strut | 12083GR | 2 | \$232.00 |
|-------------------------------|------------------------|----------------|---|----------|

COIL SPRINGS

| | Est. Lift | Additional Load | | |
|-------------------------|-----------|-----------------|----------------|---|
| Medium - 4 Cyl Carb | 35mm | 0 - 50kg | SUZ005B | 1 |
| Medium - V6 / 4 Cyl Inj | 35mm | 0 - 50kg | SUZ015B | 1 |
| Medium - XL7 | 35mm | 0 - 50kg | SUZ017B | 1 |

CAMBER CORRECTION

| | | | | |
|-----------------|--|------------------|---|---------|
| Camber Bolt Kit | | ICAMBER12 | 1 | \$30.00 |
|-----------------|--|------------------|---|---------|

REAR SUSPENSION

SHOCK ABSORBER

| | | | | |
|-------------------------|-----|----------------|---|----------|
| Nitro Gas - Performance | SWB | 12089GR | 2 | \$160.00 |
|-------------------------|-----|----------------|---|----------|

| | | | | |
|-------------------------|-----|----------------|---|----------|
| Nitro Gas - Performance | LWB | 12658GR | 2 | \$160.00 |
|-------------------------|-----|----------------|---|----------|

COIL SPRINGS

| | Est. Lift | Additional Load | | |
|--------------|-----------|-----------------|----------------|---|
| Medium - SWB | 35mm | 0 - 200kg | SUZ013B | 1 |
| Medium - LWB | 35mm | 0 - 200kg | SUZ016B | 1 |
| Medium - XL7 | 35mm | 0 - 200kg | SUZ018B | 1 |

SUSPENSION KIT - Specify Front Coil Springs When Ordering

| | | | |
|--------------------|-----|------------------|-----------|
| Medium - Nitro Gas | SWB | SUZ013BKG | \$1333.00 |
|--------------------|-----|------------------|-----------|

| | | | |
|--------------------|-----|------------------|-----------|
| Medium - Nitro Gas | LWB | SUZ016BKG | \$1333.00 |
|--------------------|-----|------------------|-----------|

| | | | |
|--------------------|-----|------------------|-----------|
| Medium - Nitro Gas | XL7 | SUZ018BKG | \$1333.00 |
|--------------------|-----|------------------|-----------|

• SWB suits short wheel base vehicles

• LWB Suits long wheel base vehicles

SUSPENSION KIT CONTENTS

Shock Absorbers

Strut Shock Absorbers

Coil Springs

Camber Correction

Suzuki Vitara



1988+

Product Description

Part No.

Qty
Req

Retail
ea Inc GST

Please check vehicle date range (if shown) next to product description prior to ordering

SUSPENSION TO SUIT SUZUKI VITARA - 1988+

FRONT SUSPENSION

SHOCK ABSORBER

| | | | | |
|-------------------------------|------------------------|----------------|---|----------|
| Nitro Gas Strut - Performance | Full replacement strut | 12083GR | 2 | \$232.00 |
|-------------------------------|------------------------|----------------|---|----------|

COIL SPRINGS

| | Est. Lift | Additional Load | | |
|--------------|-----------|-----------------|----------------|---|
| Medium - SWB | 35mm | 0 - 50kg | SUZ003B | 1 |
| Medium - LWB | 35mm | 0 - 50kg | SUZ005B | 1 |

CAMBER CORRECTION

| | | | | |
|-----------------|--|------------------|---|---------|
| Camber Bolt Kit | | ICAMBER12 | 1 | \$30.00 |
|-----------------|--|------------------|---|---------|

REAR SUSPENSION

SHOCK ABSORBER

| | | | | |
|-------------------------|-----|----------------|---|----------|
| Nitro Gas - Performance | SWB | 12089GR | 2 | \$160.00 |
| Nitro Gas - Performance | LWB | 12658GR | 2 | \$160.00 |

COIL SPRINGS

| | Est. Lift | Additional Load | | |
|--------------|-----------|-----------------|----------------|---|
| Medium - SWB | 35mm | 0 - 200kg | SUZ004B | 1 |
| Medium - LWB | 35mm | 0 - 200kg | SUZ006B | 1 |

SUSPENSION KIT - Specify Front Coil Springs When Ordering

| | | | |
|--------------------|-----|------------------|-----------|
| Medium - Nitro Gas | SWB | SUZ003BKG | \$1333.00 |
| Medium - Nitro Gas | LWB | SUZ005BKG | \$1333.00 |

- SWB suits short wheel base vehicles
- LWB Suits long wheel base vehicles

SUSPENSION KIT CONTENTS

| | |
|-----------------|-----------------------|
| Shock Absorbers | Strut Shock Absorbers |
| Coil Springs | Camber Correction |



Toyota 4Runner

Gen 5, N280
2009+



Product Description

Part No.

Qty
Req

Retail
ea Inc GST

Please check vehicle date range (if shown) next to product description prior to ordering

ACCESSORIES TO SUIT TOYOTA 4RUNNER - 2009+

STEEL WINCH BULL BARS

Raid Stubby Bumper - Not Available in Australia

BBR078

-

• Raid Bull Bars are compatible with Ironman 4x4 Lightbars, refer below for available options

LIGHTING OPTIONS - TO SUIT RAID BULL BARS

75W Bright Sabre Single Row Lightbar 524mm (20") Straight

ILBSR003BW

1

\$198.00

STEEL SIDE STEPS

Raid Rock Slider

SS078

\$1003.00

TOWING

Raid Rear Bumper*

RTB078

\$1103.00

** Compatible with Ironman 4x4 Cube Lights, refer below for available options*

LIGHTING OPTIONS - TO SUIT RAID REAR BARS (4 CUBE LIGHTS PER VEHICLE)

20W Bright Cube Spot Beam LED Cube Light - 70 x 64mm (Each) - Clear

ILED20B

2

\$62.00

20W Bright Cube Spot Beam LED Cube Light - 70 x 64mm (Each) - Amber

ILED20BA

2

\$62.00

20W Bright Cube Flood Beam LED Cube Light - 70 x 64mm (Each) - Clear

ILED20BF

2

\$62.00

20W Bright Cube Flood Beam LED Cube Light - 70 x 64mm (Each) - Amber

ILED20BFA

2

\$62.00

20W Bright Cube Flood Beam LED Cube Light - 70 x 64mm (Each) - Red

ILED20BFR

2

\$62.00

PREMIUM UNDERBODY PROTECTION

Engine Bay and Transmission for models without KDSS

UBP047

\$782.00

BREATHER KIT

Universal Twin Manifold Filtered Breather Kit

IDIFFBRE

\$115.00



Toyota 4Runner

Gen 4 and 5, N210-N280
2003+

Product Description

Part No.

Qty
ReqRetail
ea Inc GST*Please check vehicle date range (if shown) next to product description prior to ordering***SUSPENSION TO SUIT TOYOTA 4RUNNER - 2003+****FRONT SUSPENSION****SHOCK ABSORBER**

| | | | | | |
|-----------------------------------|--|--|----------------|---|----------|
| Nitro Gas Strut - Performance | | | 12710GR | 2 | \$232.00 |
| Foam Cell Strut - Performance | | | 24710FE | 2 | \$262.00 |
| Foam Cell Pro Strut - Performance | | | 45710FE | 2 | \$406.00 |

COIL SPRINGS

| | Est. Lift | Additional Load | | | |
|--------|-----------|-----------------|----------------|---|----------|
| Light | 30mm | 0 - 50kg | TOY055B | 1 | \$262.00 |
| Medium | 45mm | 0 - 50kg | TOY065B | 1 | \$262.00 |
| Heavy | 45mm | 50 - 110kg | TOY065C | 1 | \$262.00 |

STRUT MOUNTS

| | | | | | |
|-----------------|--|--|----------------|---|---------|
| Steel Strut Top | | | ISST001 | 2 | \$88.00 |
|-----------------|--|--|----------------|---|---------|

TRIM PACKERS

| | | | | |
|------------------------|-----------------------|-------------------------|---|---------|
| 5mm Strut Trim Packer | Nitro Gas / Foam Cell | HILFR05/HILFR05F | 2 | \$30.00 |
| 10mm Strut Trim Packer | Nitro Gas / Foam Cell | HILFR10/HILFR10F | 2 | \$30.00 |
| 15mm Strut Trim Packer | Nitro Gas / Foam Cell | HILFR15/HILFR15F | 2 | \$30.00 |

• ONLY Compatible with Ironman 4x4 Struts (except Pro), lift height subject to 2:1 motion ratio. Unnecessary fitment may lift vehicle too high

CONTROL ARMS

| | | | | | |
|------------------------------|--|--|-----------------|---|----------|
| Pro-Forge Upper Control Arms | | | UCA001FA | 1 | \$882.00 |
|------------------------------|--|--|-----------------|---|----------|

SPACER KIT

| | | | | | |
|-------------------------|--|--|--------------|---|----------|
| Sway Bar Spacer | | | 1198K | 1 | \$102.00 |
| Offset Sway Bar Bracket | | | 1209K | 1 | \$146.00 |

REAR SUSPENSION**SHOCK ABSORBER**

| | | | | | |
|------------------------------|--|--|-----------------|---|----------|
| Nitro Gas - Comfort | | | 12682GRC | 2 | \$160.00 |
| Nitro Gas - Professional | | | 12682GRP | 2 | \$160.00 |
| Foam Cell - Comfort | | | 24682FEC | 2 | \$232.00 |
| Foam Cell - Professional | | | 24682FEP | 2 | \$232.00 |
| Foam Cell Pro - Comfort | | | 45682FEC | 2 | \$319.00 |
| Foam Cell Pro - Professional | | | 45682FEP | 2 | \$319.00 |

COIL SPRINGS

| | Est. Lift | Additional Load | | | |
|--------------------|-----------|-----------------|----------------|---|----------|
| Light | 30mm | 0 - 300kg | TOY056A | 1 | \$262.00 |
| Medium | 45mm | 0 - 300kg | TOY056B | 1 | \$262.00 |
| Heavy | 45mm | 300kg - GVM | TOY056C | 1 | \$262.00 |
| Air Bag Delete Kit | | | 1218ADK | 1 | \$456.00 |

COIL SPACER

| | | | | | |
|-------------------|--|--|---------------|---|---------|
| Polyurethane 20mm | | | LCPR20 | 2 | \$30.00 |
| Polyurethane 25mm | | | LCPR25 | 2 | \$44.00 |

PANHARD ROD

| | | | | | |
|------------------------|--|--|-------------------|---|----------|
| Adjustable Panhard Rod | | | PANHARD015 | 1 | \$334.00 |
|------------------------|--|--|-------------------|---|----------|

SWAY BAR LINK

| | | | | | |
|------------------------|--|--|-----------------|---|----------|
| Extended Sway Bar Link | | | SBEXT006 | 2 | \$88.00 |
| KDSS Spacer Brackets | | | 1220K | 1 | \$149.00 |

SUSPENSION KIT - Specify Front Coil Springs When Ordering

| | | |
|------------------------|------------------|-----------|
| Light - Nitro Gas | TOY055AKG | \$1304.00 |
| Light - Foam Cell | TOY055AKF | \$1506.00 |
| Light - Foam Cell Pro | TOY055AKP | \$2115.00 |
| Medium - Nitro Gas | TOY055BKG | \$1304.00 |
| Medium - Foam Cell | TOY055BKF | \$1506.00 |
| Medium - Foam Cell Pro | TOY055BKP | \$2115.00 |
| Heavy - Nitro Gas | TOY055CKG | \$1304.00 |
| Heavy - Foam Cell | TOY055CKF | \$1506.00 |
| Heavy - Foam Cell Pro | TOY055CKP | \$2115.00 |

SUSPENSION KIT CONTENTS

| | |
|-----------------|---|
| Shock Absorbers | Strut Shock Absorbers |
| Coil Springs | Offset Sway Bar Bracket (Pro Kits Only) |

Toyota 4Runner

Gen 3 N180-N185
1996 to 2002



Product Description

Part No.

Qty
Req

Retail
ea Inc GST

Please check vehicle date range (if shown) next to product description prior to ordering

SUSPENSION TO SUIT TOYOTA 4RUNNER - 1996-2002

FRONT SUSPENSION

SHOCK ABSORBER

| | | | | | |
|-----------------------------------|--|--|----------------|---|----------|
| Nitro Gas Strut - Performance | | | 12691GR | 2 | \$232.00 |
| Foam Cell Strut - Performance | | | 24691FE | 2 | \$262.00 |
| Foam Cell Pro Strut - Performance | | | 45691FE | 2 | \$406.00 |

COIL SPRINGS

| | Est. Lift | Additional Load | | | |
|--------|-----------|-----------------|----------------|---|----------|
| Medium | 45mm | 0 - 50kg | TOY038B | 1 | \$262.00 |
| Heavy | 45mm | 50 - 110kg | TOY038C | 1 | \$262.00 |

STRUT MOUNTS

| | | | | | |
|-----------------|--|--|----------------|---|---------|
| Steel Strut Top | | | ISST001 | 2 | \$88.00 |
|-----------------|--|--|----------------|---|---------|

TRIM PACKERS

| | | | | |
|------------------------|-----------------------|-------------------------|---|---------|
| 5mm Strut Trim Packer | Nitro Gas / Foam Cell | HILFR05/HILFR05F | 2 | \$30.00 |
| 10mm Strut Trim Packer | Nitro Gas / Foam Cell | HILFR10/HILFR10F | 2 | \$30.00 |
| 15mm Strut Trim Packer | Nitro Gas / Foam Cell | HILFR15/HILFR15F | 2 | \$30.00 |

• ONLY Compatible with Ironman 4x4 Struts (except Pro), lift height subject to 2:1 motion ratio. Unnecessary fitment may lift vehicle too high

REAR SUSPENSION

SHOCK ABSORBER

| | | | | | |
|-----------------------------|--|--|----------------|---|----------|
| Nitro Gas - Performance | | | 12661GR | 2 | \$160.00 |
| Foam Cell - Performance | | | 24661FE | 2 | \$232.00 |
| Foam Cell Pro - Performance | | | 45661FE | 2 | \$319.00 |

COIL SPRINGS

| | Est. Lift | Additional Load | | | |
|--------|-----------|-----------------|----------------|---|----------|
| Light | 30mm | 0 - 200kg | TOY039A | 1 | \$262.00 |
| Medium | 45mm | 0 - 300kg | TOY039B | 1 | \$262.00 |
| Heavy | 45mm | 300kg - GVM | TOY039C | 1 | \$262.00 |

COIL SPACER

| | | | | | |
|-------------------|--|--|--------------|---|---------|
| Polyurethane 20mm | | | LCF20 | 2 | \$30.00 |
| Polyurethane 30mm | | | LCF30 | 2 | \$44.00 |

SUSPENSION KIT - Specify Front Coil Springs When Ordering

| | | |
|------------------------|-------------------|-----------|
| Light - Nitro Gas | TOY038AKG | \$1304.00 |
| Light - Foam Cell | TOY038AKF | \$1506.00 |
| Light - Foam Cell Pro | TOY038AKP | \$1969.00 |
| Medium - Nitro Gas | TOY038BKG | \$1304.00 |
| Medium - Foam Cell | TOY038BKF | \$1506.00 |
| Medium - Foam Cell Pro | TOY038BKP | \$1969.00 |
| Heavy - Nitro Gas | TOY038BKG1 | \$1304.00 |
| Heavy - Foam Cell | TOY038BKF1 | \$1506.00 |
| Heavy - Foam Cell Pro | TOY038BKP1 | \$1969.00 |

SUSPENSION KIT CONTENTS

Shock Absorbers
Coil Springs

Strut Shock Absorbers

Toyota 4Runner

Gen 2 Surf, N130 V6 (Coil)
1990 to 1997

Product Description

Part No.

Qty
ReqRetail
ea Inc GST*Please check vehicle date range (if shown) next to product description prior to ordering***SUSPENSION TO SUIT TOYOTA 4RUNNER - 1990-1997****FRONT SUSPENSION****SHOCK ABSORBER**

| | | | |
|-------------------------|----------------|---|----------|
| Nitro Gas - Performance | 12088GR | 2 | \$160.00 |
| Foam Cell - Performance | 24088FE | 2 | \$232.00 |

TORSION BAR

| | | | |
|----------------------|---------------|---|----------|
| Uprated Torsion Bars | TOY026 | 1 | \$435.00 |
|----------------------|---------------|---|----------|

- Minimum 60mm downward suspension travel required after adjustment.

STEERING DAMPER

| | | | |
|-----------|-------------|---|----------|
| Foam Cell | 3533 | 1 | \$175.00 |
|-----------|-------------|---|----------|

REAR SUSPENSION**SHOCK ABSORBER**

| | | | |
|-------------------------|-----------------|---|----------|
| Nitro Gas - Comfort | 12637GRC | 2 | \$160.00 |
| Nitro Gas - Performance | 12637GR | 2 | \$160.00 |
| Foam Cell - Comfort | 24637FEC | 2 | \$232.00 |
| Foam Cell - Performance | 24637FE | 2 | \$232.00 |

COIL SPRINGS

| | Est. Lift | Additional Load | | | |
|--------|-----------|-----------------|----------------|---|----------|
| Medium | 45mm | 0 -200kg | TOY023B | 1 | \$262.00 |
| Heavy | 45mm | 200kg - GVM | TOY023C | 1 | \$262.00 |

SUSPENSION KIT

| | | |
|--------------------|------------------|-----------|
| Medium - Nitro Gas | TOY023BKG | \$1333.00 |
| Medium - Foam Cell | TOY023BKF | \$1622.00 |
| Heavy - Nitro Gas | TOY023CKG | \$1333.00 |
| Heavy - Foam Cell | TOY023CKF | \$1622.00 |

SUSPENSION KIT CONTENTS

| | |
|-----------------|--------------|
| Shock Absorbers | Torsion Bars |
| Coil Springs | |

Toyota 4Runner

Gen 1, N60 (Leaf)
1988 to 1997



Product Description

Part No.

Qty
Req

Retail
ea Inc GST

Please check vehicle date range (if shown) next to product description prior to ordering

SUSPENSION TO SUIT TOYOTA 4RUNNER - 1988-1997

FRONT SUSPENSION

SHOCK ABSORBER

| | | | |
|-------------------------|----------------|---|----------|
| Nitro Gas - Performance | 12088GR | 2 | \$160.00 |
| Foam Cell - Performance | 24088FE | 2 | \$232.00 |

TORSION BAR

| | | | |
|-----------------------|---------------|---|----------|
| Up-rated Torsion Bars | TOY026 | 1 | \$435.00 |
|-----------------------|---------------|---|----------|

• Minimum 60mm downward suspension travel required after adjustment

STEERING DAMPER

| | | | |
|-----------|-------------|---|----------|
| Foam Cell | 3533 | 1 | \$175.00 |
|-----------|-------------|---|----------|

REAR SUSPENSION

SHOCK ABSORBER

| | | | |
|--------------------------|-----------------|---|----------|
| Nitro Gas - Comfort | 12650GRC | 2 | \$160.00 |
| Nitro Gas - Performance | 12650GR | 2 | \$160.00 |
| Foam Cell - Comfort | 24650FEC | 2 | \$232.00 |
| Foam Cell - Performance | 24650FE | 2 | \$232.00 |
| Foam Cell - Professional | 24650FEP | 2 | \$232.00 |

LEAF SPRINGS

| | Est. Lift | Additional Load | | | |
|--------|-----------|-----------------|----------------|---|----------|
| Medium | 50mm | 0-300kg | TOY011B | 2 | \$392.00 |
| Heavy | 50mm | 300kg - GVM | TOY011C | 2 | \$421.00 |

• 1200mm Leaf Length

U-BOLTS

| | | | |
|------------|---------------|---|---------|
| U-Bolt Kit | 437UBK | 2 | \$44.00 |
|------------|---------------|---|---------|

POLYURETHANE SPRING BUSHES

| | | | |
|----------|--------------|---|---------|
| Bush Kit | 733UK | 1 | \$74.00 |
|----------|--------------|---|---------|

GREASABLE SHACKLES AND PINS

| | | | | |
|-------------------|-------------------------------|--------------|---|---------|
| Greasable Shackle | Straight Shackle | 386 | 2 | \$59.00 |
| Greasable Shackle | Straight Shackle Extended 5mm | 386-2 | 2 | \$59.00 |
| Greasable Pin | | 385 | 2 | \$44.00 |

HELPER SPRINGS

| | | | |
|--------------------------|----------------|---|----------|
| Load Plus Helper Springs | LP2 | 1 | \$165.00 |
| Add-A-Leaf | ISL6010 | 1 | \$175.00 |

SUSPENSION KIT

| | | |
|--------------------|------------------|-----------|
| Medium - Nitro Gas | TOY011BKG | \$2013.00 |
| Medium - Foam Cell | TOY011BKF | \$2303.00 |
| Heavy - Nitro Gas | TOY011CKG | \$2071.00 |
| Heavy - Foam Cell | TOY011CKF | \$2360.00 |

SUSPENSION KIT CONTENTS

| | | |
|-----------------|--------------|----------------------------|
| Shock Absorbers | Torsion Bars | Polyurethane Spring Bushes |
| Leaf Springs | U-Bolts | |

Toyota Rav4

2019 to 2021

Product Description

Part No.

Qty
ReqRetail
ea Inc GST*Please check vehicle date range (if shown) next to product description prior to ordering***SUSPENSION TO SUIT TOYOTA RAV4 - 2019-2021****FRONT SUSPENSION****SHOCK ABSORBER**

| | Est. Lift | Additional Load | | | |
|--------------------------------|-----------|-----------------|----------------------|---|----------|
| Nitro Gas Strut Assembly Left | 50mm | 0 - 50kg | 12840080GR LH | 1 | \$493.00 |
| Nitro Gas Strut Assembly Right | 50mm | 0 - 50kg | 12840080GR RH | 1 | \$493.00 |

- Strut Assembly includes pre-assembled Coil Springs, Shock Absorber and Strut Top Cap

COIL SPRINGS

| | Est. Lift | Additional Load | | | |
|-------|-----------|-----------------|----------------|---|----------|
| Light | 50mm | 0-50kg | TOY080A | 1 | \$262.00 |

CAMBER CORRECTION

| | | | | | |
|-----------------|--|--|------------------|---|---------|
| Camber Bolt Kit | | | ICAMBER17 | 1 | \$45.00 |
|-----------------|--|--|------------------|---|---------|

REAR SUSPENSION**SHOCK ABSORBER**

| | | | | | |
|-------------------------|--|--|----------------|---|----------|
| Nitro Gas - Performance | | | 12842GR | 1 | \$160.00 |
|-------------------------|--|--|----------------|---|----------|

COIL SPRINGS

| | Est. Lift | Additional Load | | | |
|-------|-----------|-----------------|----------------|---|----------|
| Light | 50mm | 0-200kg | TOY082A | 1 | \$262.00 |

SUSPENSION KIT

| | | | | | |
|--------------------|--|--|------------------|--|-----------|
| Medium - Nitro Gas | | | TOY080AKG | | \$1568.00 |
|--------------------|--|--|------------------|--|-----------|

SUSPENSION KIT CONTENTS

Left / Right Front Strut Assemblies

Rear Coil Springs

Rear Shock Absorbers

Toyota FJ Cruiser

2006+



Product Description

Part No.

Qty
Req

Retail
ea Inc GST

Please check vehicle date range (if shown) next to product description prior to ordering

ACCESSORIES TO SUIT TOYOTA FJ CRUISER - 2006+

STEEL WINCH BULL BARS

Commercial Deluxe

BBCD037

\$2345.00

PREMIUM UNDERBODY PROTECTION

Engine Bay and Transmission

UBP047

\$782.00

BREATHER KIT

Universal Twin Manifold Filtered Breather Kit

IDIFFBRE

\$115.00



2006+

Toyota FJ Cruiser

| Product Description | Part No. | Qty Req | Retail ea Inc GST |
|---------------------|----------|---------|-------------------|
|---------------------|----------|---------|-------------------|

Please check vehicle date range (if shown) next to product description prior to ordering

SUSPENSION TO SUIT TOYOTA FJ CRUISER - 2006+

FRONT SUSPENSION

SHOCK ABSORBER

| | | | | |
|-----------------------------------|--|----------------|---|----------|
| Nitro Gas Strut - Performance | | 12710GR | 2 | \$232.00 |
| Foam Cell Strut - Performance | | 24710FE | 2 | \$262.00 |
| Foam Cell Pro Strut - Performance | | 45710FE | 2 | \$406.00 |

• Foam Cell Pro, must fit 1198K spacer for Sway Bar clearance

COIL SPRINGS

| | Est. Lift | Additional Load | | | |
|--------|-----------|-----------------|----------------|---|----------|
| Light | 30mm | 0 - 50kg | TOY055A | 1 | \$262.00 |
| Medium | 45mm | 0 - 50kg | TOY055B | 1 | \$262.00 |
| Heavy | 45mm | 50 - 110kg | TOY055C | 1 | \$262.00 |

STRUT MOUNTS

| | | | | |
|-----------------|--|----------------|---|---------|
| Steel Strut Top | | ISST001 | 2 | \$88.00 |
|-----------------|--|----------------|---|---------|

TRIM PACKERS

| | | | | |
|------------------------|-----------------------|-------------------------|---|---------|
| 5mm Strut Trim Packer | Nitro Gas / Foam Cell | HILFR05/HILFR05F | 2 | \$30.00 |
| 10mm Strut Trim Packer | Nitro Gas / Foam Cell | HILFR10/HILFR10F | 2 | \$30.00 |
| 15mm Strut Trim Packer | Nitro Gas / Foam Cell | HILFR15/HILFR15F | 2 | \$30.00 |

• ONLY Compatible with Ironman 4x4 Struts (except Pro), lift height subject to 2:1 motion ratio. Unnecessary fitment may lift vehicle too high

CONTROL ARMS

| | | | | |
|------------------------------|--|-----------------|---|----------|
| Pro-Forge Upper Control Arms | | UCA001FA | 1 | \$882.00 |
|------------------------------|--|-----------------|---|----------|

SPACER KIT

| | | | | |
|-------------------------|--|--------------|---|----------|
| Sway Bar Spacer | | 1198K | 1 | \$102.00 |
| Offset Sway Bar Bracket | | 1209K | 1 | \$146.00 |

REAR SUSPENSION

SHOCK ABSORBER

| | | | | |
|------------------------------|--|-----------------|---|----------|
| Nitro Gas - Comfort | | 12682GRC | 2 | \$160.00 |
| Nitro Gas - Performance | | 12682GR | 2 | \$160.00 |
| Nitro Gas - Professional | | 12682GRP | 2 | \$160.00 |
| Foam Cell - Comfort | | 24682FEC | 2 | \$232.00 |
| Foam Cell - Performance | | 24682FE | 2 | \$232.00 |
| Foam Cell - Professional | | 24682FEP | 2 | \$232.00 |
| Foam Cell Pro - Comfort | | 45682FEC | 2 | \$319.00 |
| Foam Cell Pro - Performance | | 45682FE | 2 | \$319.00 |
| Foam Cell Pro - Professional | | 45682FEP | 2 | \$319.00 |

COIL SPRINGS

| | Est. Lift | Additional Load | | | |
|--------|-----------|-----------------|----------------|---|----------|
| Light | 40mm | 0 - 300kg | TOY056A | 1 | \$262.00 |
| Medium | 50mm | 0 - 300kg | TOY056B | 1 | \$262.00 |
| Heavy | 50mm | 300kg - GVM | TOY069B | 1 | \$262.00 |

PANHARD ROD

| | | | | |
|------------------------|--|-------------------|---|----------|
| Adjustable Panhard Rod | | PANHARD015 | 1 | \$334.00 |
|------------------------|--|-------------------|---|----------|

SWAY BAR LINK

| | | | | |
|------------------------|--|-----------------|---|---------|
| Extended Sway Bar Link | | SBEXT006 | 2 | \$88.00 |
|------------------------|--|-----------------|---|---------|

BUMP STOP

| | | | | |
|----------------------|--|--------------|---|----------|
| Internal Rubber Cone | | 1218R | 2 | \$135.00 |
|----------------------|--|--------------|---|----------|

SUSPENSION KIT - Specify Front Coil Springs When Ordering

| | | |
|------------------------|------------------|-----------|
| Light - Nitro Gas | TOY055AKG | \$1304.00 |
| Light - Foam Cell | TOY055AKF | \$1506.00 |
| Light - Foam Cell Pro | TOY055AKP | \$2115.00 |
| Medium - Nitro Gas | TOY055BKG | \$1304.00 |
| Medium - Foam Cell | TOY055BKF | \$1506.00 |
| Medium - Foam Cell Pro | TOY055BKP | \$2115.00 |
| Heavy - Nitro Gas | TOY055CKG | \$1304.00 |
| Heavy - Foam Cell | TOY055CKF | \$1506.00 |
| Heavy - Foam Cell Pro | TOY055CKP | \$2115.00 |

SUSPENSION KIT CONTENTS

| | |
|-----------------|---|
| Shock Absorbers | Strut Shock Absorbers |
| Coil Springs | Offset Sway Bar Bracket (Pro Kits Only) |

Toyota Fortuner

2015 to 9/2020
(Facelift) 2020+



Product Description

Part No.

Qty
Req

Retail
ea Inc GST

Please check vehicle date range (if shown) next to product description prior to ordering

ACCESSORIES TO SUIT TOYOTA FORTUNER - 2015+

STEEL WINCH BULL BARS

| | | |
|--|------------------|-----------|
| Commercial Deluxe - (2015 to 2/2020 Only) | BBCD053 | \$2345.00 |
| Commercial Deluxe - (2020+ facelift Only) | BBCD081 | \$2345.00 |
| Protector - (2015 to 2/2020 Only) | BBT053 | \$2271.00 |
| Proguard No Loop - (2015 to 2/2020 Only) | BBT053-NL | \$1939.00 |
| Proguard No Loop - (2020+ facelift Only) | BBT081-NL | \$1939.00 |
| Proguard Single Loop Kit - (2015 to 2/2020 Only) | BB053-SL | \$352.00 |
| Proguard Single Loop Kit - (2020+ facelift Only) | BB081-SL | \$352.00 |
| Proguard Triple Loop Kit - (2015 to 2/2020 Only) | BB053-TL | \$423.00 |
| Proguard Triple Loop Kit - (2020+ facelift Only) | BB081-TL | \$423.00 |

STEEL SIDE STEPS AND RAILS

| | | |
|----------------------|-------------------|-----------|
| Side Steps | SS053 | \$1006.00 |
| Side Rails | SS053 RAIL | \$332.00 |
| Side Steps and Rails | SSR053 | \$1207.00 |

RECOVERY POINTS - IRONMAN 4X4 BULL BAR ONLY

| | | |
|--|---------------|----------|
| Recovery Points - 5000kg Rating (Pair) | IRP051 | \$227.00 |
|--|---------------|----------|

PREMIUM UNDERBODY PROTECTION

| | | |
|-----------------------------|---------------|----------|
| Engine Bay and Transmission | UBP051 | \$782.00 |
|-----------------------------|---------------|----------|

SNORKEL

| | | |
|-------------|--------------------|----------|
| 2.8L Diesel | ISNORKEL053 | \$437.00 |
|-------------|--------------------|----------|

SEAT COVER

| | | |
|------------------------|-----------------|----------|
| Canvas Comfort - Front | ICSC053F | \$420.00 |
| Canvas Comfort - Rear | ICSC053R | \$420.00 |

BREATHER KIT

| | | |
|---|-----------------|----------|
| Universal Twin Manifold Filtered Breather Kit | IDIFFBRE | \$115.00 |
|---|-----------------|----------|



Toyota Fortuner

2015+

Product Description

Part No.

Qty
ReqRetail
ea Inc GST

Please check vehicle date range (if shown) next to product description prior to ordering

SUSPENSION TO SUIT TOYOTA FORTUNER - 2015+

FRONT SUSPENSION

SHOCK ABSORBER

| | | | | | |
|-----------------------------------|--|--|----------------|---|----------|
| Nitro Gas Strut - Performance | | | 12730GR | 2 | \$232.00 |
| Foam Cell Strut - Performance | | | 24730FE | 2 | \$262.00 |
| Foam Cell Pro Strut - Performance | | | 45730FE | 2 | \$406.00 |

• Operating clearance to sway bar can be increased by installing 1210K offset sway bar bracket

COIL SPRINGS

| | Est. Lift | Additional Load | | | |
|--------|-----------|-----------------|----------------|---|----------|
| Medium | 30mm | 0 - 50kg | TOY055A | 1 | \$262.00 |
| Heavy | 40mm | 50 - 110kg | TOY055B | 1 | \$262.00 |

STRUT MOUNTS

| | | | | | |
|-----------------|--|--|----------------|---|---------|
| Steel Strut Top | | | ISST001 | 2 | \$88.00 |
|-----------------|--|--|----------------|---|---------|

TRIM PACKERS

| | | | | | |
|------------------------|-----------------------|--|-------------------------|---|---------|
| 5mm Strut Trim Packer | Nitro Gas / Foam Cell | | HILFR05/HILFR05F | 2 | \$30.00 |
| 10mm Strut Trim Packer | Nitro Gas / Foam Cell | | HILFR10/HILFR10F | 2 | \$30.00 |
| 15mm Strut Trim Packer | Nitro Gas / Foam Cell | | HILFR15/HILFR15F | 2 | \$30.00 |

• ONLY Compatible with Ironman 4x4 Struts (except Pro), lift height subject to 2:1 motion ratio. Unnecessary fitment may lift vehicle too high

CONTROL ARMS

| | | | | | |
|------------------------------|--|--|-----------------|---|----------|
| Pro-Forge Upper Control Arms | | | UCA001FA | 1 | \$882.00 |
|------------------------------|--|--|-----------------|---|----------|

SWAY BAR

| | | | | | |
|-------------------------|--|--|--------------|---|----------|
| Offset Sway Bar Bracket | | | 1210K | 1 | \$146.00 |
|-------------------------|--|--|--------------|---|----------|

REAR SUSPENSION

SHOCK ABSORBER

| | | | | | |
|-----------------------------|--|--|-----------------|---|----------|
| Nitro Gas - Comfort | | | 12743GRC | 2 | \$160.00 |
| Nitro Gas - Performance | | | 12743GR | 2 | \$160.00 |
| Foam Cell - Comfort | | | 24743FEC | 2 | \$232.00 |
| Foam Cell - Performance | | | 24743FE | 2 | \$232.00 |
| Foam Cell Pro - Comfort | | | 45743FEC | 2 | \$319.00 |
| Foam Cell Pro - Performance | | | 45743FE | 2 | \$319.00 |

COIL SPRINGS

| | Est. Lift | Additional Load | | | |
|----------|-----------|-----------------|----------------|---|----------|
| Standard | 0mm | 0 - 200kg | TOY017S | 1 | \$262.00 |
| Medium | 30mm | 0 - 200kg | TOY017A | 1 | \$262.00 |
| Heavy | 40mm | 100 - 300kg | TOY017B | 1 | \$262.00 |

• Possible driveline vibration may occur, use 1192K Centre Bearing Spacer Kit

SPACER KIT

| | | | | | |
|---------------------------|--|--|--------------|---|---------|
| Centre Bearing Spacer Kit | | | 1192K | 1 | \$30.00 |
|---------------------------|--|--|--------------|---|---------|

SUSPENSION KIT - Specify Front Coil Springs When Ordering

| | | |
|------------------------|-------------------|-----------|
| Medium - Nitro Gas | TOY017AKG1 | \$1333.00 |
| Medium - Foam Cell | TOY017AKF1 | \$1536.00 |
| Medium - Foam Cell Pro | TOY017AKP1 | \$2144.00 |
| Heavy - Nitro Gas | TOY017BKG1 | \$1333.00 |
| Heavy - Foam Cell | TOY017BKF1 | \$1536.00 |
| Heavy - Foam Cell Pro | TOY017BKP1 | \$2245.00 |

• Possible driveline vibration may occur if raised above 40mm

SUSPENSION KIT CONTENTS

Shock Absorbers

Strut Shock Absorbers

Offset Sway Bar Bracket (Pro Kits Only)

Coil Springs

Centre Bearing Spacer Kit



sometimes the best things in life come in fun size



for a full range of accessories visit our website

www.ironman4x4.com



Toyota Fortuner

2004 to 2015



Product Description

Part No.

Qty
ReqRetail
ea Inc GST

Please check vehicle date range (if shown) next to product description prior to ordering

SUSPENSION TO SUIT TOYOTA FORTUNER - 2004-2015

FRONT SUSPENSION

SHOCK ABSORBER

| | | | | | |
|-----------------------------------|--|--|----------------|---|----------|
| Nitro Gas Strut - Performance | | | 12710GR | 2 | \$232.00 |
| Foam Cell Strut - Performance | | | 24710FE | 2 | \$262.00 |
| Foam Cell Pro Strut - Performance | | | 45710FE | 2 | \$406.00 |

• Foam Cell Pro, must fit 1198K spacer for Sway Bar clearance

COIL SPRINGS

| | Est. Lift | Additional Load | | | |
|----------|-----------|-----------------|----------------|---|----------|
| Standard | 0mm | 0 - 50kg | TOY038B | 1 | \$262.00 |
| Medium | 45mm | 0 - 50kg | TOY055A | 1 | \$262.00 |
| Heavy | 45mm | 50 - 110kg | TOY055B | 1 | \$262.00 |

STRUT MOUNTS

| | | | | | |
|-----------------|--|--|----------------|---|---------|
| Steel Strut Top | | | ISST001 | 2 | \$88.00 |
|-----------------|--|--|----------------|---|---------|

TRIM PACKERS

| | | | | | |
|------------------------|-----------------------|--|-------------------------|---|---------|
| 5mm Strut Trim Packer | Nitro Gas / Foam Cell | | HILFR05/HILFR05F | 2 | \$30.00 |
| 10mm Strut Trim Packer | Nitro Gas / Foam Cell | | HILFR10/HILFR10F | 2 | \$30.00 |
| 15mm Strut Trim Packer | Nitro Gas / Foam Cell | | HILFR15/HILFR15F | 2 | \$30.00 |

• ONLY Compatible with Ironman 4x4 Struts (except Pro), lift height subject to 2:1 motion ratio. Unnecessary fitment may lift vehicle too high

CONTROL ARMS

| | | | | | |
|------------------------------|--|--|-----------------|---|----------|
| Pro-Forge Upper Control Arms | | | UCA001FA | 1 | \$882.00 |
|------------------------------|--|--|-----------------|---|----------|

SPACER KIT

| | | | | | |
|-----------------|--|--|--------------|---|----------|
| Sway Bar Spacer | | | 1198K | 1 | \$102.00 |
|-----------------|--|--|--------------|---|----------|

REAR SUSPENSION

SHOCK ABSORBER

| | | | | | |
|-----------------------------|--|--|-----------------|---|----------|
| Nitro Gas - Comfort | | | 12743GRC | 2 | \$160.00 |
| Nitro Gas - Performance | | | 12743GR | 2 | \$160.00 |
| Foam Cell - Comfort | | | 24743FEC | 2 | \$232.00 |
| Foam Cell - Performance | | | 24743FE | 2 | \$232.00 |
| Foam Cell Pro - Comfort | | | 45743FEC | 2 | \$319.00 |
| Foam Cell Pro - Performance | | | 45743FE | 2 | \$319.00 |

COIL SPRINGS

| | Est. Lift | Additional Load | | | |
|----------|-----------|-----------------|----------------|---|----------|
| Standard | 0mm | 0 - 200kg | TOY017S | 1 | \$262.00 |
| Light | 40mm | 0 - 200kg | TOY017A | 1 | \$262.00 |
| Medium | 45mm | 0 - 300kg | TOY017B | 1 | \$262.00 |

SPACER KIT

| | | | | | |
|---------------------------|--|--|--------------|---|---------|
| Centre Bearing Spacer Kit | | | 1192K | 1 | \$30.00 |
|---------------------------|--|--|--------------|---|---------|

SUSPENSION KIT - Specify Front Coil Springs When Ordering

| | | |
|--------------------------|------------------|-----------|
| Standard - Nitro Gas | TOY017SKG | \$1304.00 |
| Standard - Foam Cell | TOY017SKF | \$2071.00 |
| Standard - Foam Cell Pro | TOY017SKP | \$2100.00 |
| Light - Nitro Gas | TOY017AKG | \$1304.00 |
| Light - Foam Cell | TOY017AKF | \$1506.00 |
| Light - Foam Cell Pro | TOY017AKP | \$2071.00 |
| Medium - Nitro Gas | TOY017BKG | \$1304.00 |
| Medium - Foam Cell | TOY017BKF | \$1506.00 |
| Medium - Foam Cell Pro | TOY017BKP | \$2071.00 |

SUSPENSION KIT CONTENTS

| | |
|-----------------|---------------------------------|
| Shock Absorbers | Strut Shock Absorbers |
| Coil Springs | Sway Bar Spacer (Pro Kits Only) |

Toyota Hiace

Series 300
2019+



Product Description

Part No.

Qty
Req

Retail
ea Inc GST

Please check vehicle date range (if shown) next to product description prior to ordering

SUSPENSION TO SUIT TOYOTA HIACE - 2019+

FRONT SUSPENSION

SHOCK ABSORBER

| | | | | | |
|-------------------------------|-----------------|--|------------------|---|----------|
| Foam Cell Strut - Performance | Left Hand Side | | 24840FELH | 1 | \$291.00 |
| Foam Cell - Performance | Right Hand Side | | 24840FERH | 1 | \$291.00 |

COIL SPRINGS

| | Est. Lift | Additional Load | | | |
|--------|-----------|-----------------|----------------|---|----------|
| Medium | 40mm | 0 - 50kg | TOY072B | 1 | \$262.00 |

REAR SUSPENSION

SHOCK ABSORBER

| | | | | | |
|-------------------------|--|--|-----------------|---|----------|
| Foam Cell - Comfort | | | 24842FEC | 2 | \$232.00 |
| Foam Cell - Performance | | | 24842FE | 2 | \$232.00 |

LEAF SPRINGS

| | Est. Lift | Additional Load | | | |
|-----------------------------------|-----------|-----------------|----------------|---|----------|
| Medium - (Single Stage Parabolic) | 45mm | 0 - 300kg | TOY073B | 2 | \$609.00 |
| Heavy - (Dual Stage Parabolic) | 45mm | 300kg - GVM | TOY073C | 2 | \$609.00 |

U-BOLTS

| | | | | | |
|------------|--|--|----------------|---|---------|
| U-Bolt Kit | | | 1106UBK | 2 | \$44.00 |
|------------|--|--|----------------|---|---------|

POLYURETHANE SPRING BUSHES

| | | | | | |
|----------|--|--|---------------|---|----------|
| Bush Kit | | | 1154UK | 1 | \$242.00 |
|----------|--|--|---------------|---|----------|

SUSPENSION KIT

| | | | | | |
|--------------------|--|--|------------------|--|-----------|
| Medium - Foam Cell | | | TOY074BKF | | \$2848.00 |
| Heavy - Foam Cell | | | TOY074CKF | | \$2848.00 |

SUSPENSION KIT CONTENTS

| | | |
|-----------------------|--------------|----------------------------|
| Shock Absorbers | Coil Springs | U-Bolts |
| Strut Shock Absorbers | Leaf Springs | Polyurethane Spring Bushes |

Toyota Hiace

Series 200
2005 to 2019

Product Description

Part No.

Qty
ReqRetail
ea Inc GST*Please check vehicle date range (if shown) next to product description prior to ordering***SUSPENSION TO SUIT TOYOTA HIACE - 2005-2019****FRONT SUSPENSION****SHOCK ABSORBER**

| | | | |
|-------------------------|----------------|---|----------|
| Nitro Gas - Performance | 12667GR | 2 | \$160.00 |
| Foam Cell - Performance | 24667FE | 2 | \$232.00 |

TORSION BAR

| | | | |
|----------------------|---------------|---|----------|
| Uprated Torsion Bars | TOY042 | 1 | \$462.00 |
|----------------------|---------------|---|----------|

• Minimum 60mm downward suspension travel required after adjustment

REAR SUSPENSION**SHOCK ABSORBER**

| | | | |
|-------------------------|-----------------|---|----------|
| Nitro Gas - Comfort | 12805GRC | 2 | \$160.00 |
| Nitro Gas - Performance | 12805GR | 2 | \$160.00 |
| Foam Cell - Performance | 24805FE | 2 | \$232.00 |

LEAF SPRINGS

| | Est. Lift | Additional Load | | | |
|-------|-----------|-----------------|----------------|---|----------|
| Heavy | 40mm | 400kg - GVM | TOY044C | 2 | \$537.00 |

U-BOLTS

| | | | |
|------------|---------------|---|---------|
| U-Bolt Kit | 415UBK | 2 | \$44.00 |
|------------|---------------|---|---------|

POLYURETHANE SPRING BUSHES

| | | | |
|----------|---------------|---|---------|
| Bush Kit | 728UKL | 1 | \$88.00 |
|----------|---------------|---|---------|

HELPER SPRINGS

| | | | |
|--------------------------|----------------|---|----------|
| Load Plus Helper Springs | LP3 | 1 | \$165.00 |
| Add-A-Leaf | ISL6010 | 1 | \$175.00 |

SUSPENSION KIT

| | | |
|-------------------|------------------|-----------|
| Heavy - Nitro Gas | TOY044CKG | \$2350.00 |
| Heavy - Foam Cell | TOY044CKF | \$2456.00 |

SUSPENSION KIT CONTENTS

| | | |
|-----------------|--------------|----------------------------|
| Shock Absorbers | Torsion Bars | Polyurethane Spring Bushes |
| Leaf Springs | U-Bolts | |



Product Description

Part No.

Qty
Req

Retail
ea Inc GST

Please check vehicle date range (if shown) next to product description prior to ordering

ACCESSORIES TO SUIT TOYOTA HILUX - 8/2020+

STEEL WINCH BULL BARS

| | | |
|--|-------------------|-----------|
| Commercial - Narrow body Hilux WorkMate Aus and NZ only (1780mm Width) | BBC065-NB | \$1723.00 |
| Commercial Deluxe - Standard body width (1860mm Width) | BBCD076 | \$2387.00 |
| Commercial Deluxe - Narrow body Hilux all regions excluding Aus and NZ (1780mm Width) | BBCD076-NB | \$2387.00 |
| Proguard No Loop - Standard body width (1860mm Width) | BBT076-NL | \$1939.00 |
| Proguard Single Loop Kit | BB076-SL | \$352.00 |
| Proguard Triple Loop Kit | BB076-TL | \$423.00 |
| Driving Light / Lightbar Patch Loom (LED Headlights Only) | IPL065 | \$38.00 |
| • Standard body width - 1860mm | | |
| • Narrow body width - 1780mm | | |

STEEL SIDE STEPS AND RAILS

| | | |
|--|-------------------|-----------|
| Side Steps - Fits Dual Cab models only | SS051 | \$1006.00 |
| Side Rails | SS051 RAIL | \$332.00 |
| Side Steps and Rails - Fits Dual Cab models only | SSR051 | \$1207.00 |

TOWING

| | | |
|--|--------------------|-----------|
| Class 4 Towbar - Compatible with Factory Rear Bumper | TB051 | \$608.00 |
| Rear Protection Towbar - Full Rear Bumper Replacement - With Side Tubes | RTB051-SP | \$1388.00 |
| Rear Protection Towbar - Full Rear Bumper Replacement - Suits Cross Traffic Radar Models | RTB051-SPR | \$1411.00 |
| Rear Protection Towbar Plates (Pair) | RTBPLATE001 | \$153.00 |
| Towbar Wiring Loom - Plug and Play | ITBL076 | \$533.00 |

RECOVERY POINTS - IRONMAN 4X4 BULL BAR ONLY

| | | |
|------------------------|---------------|----------|
| Recovery Points (Pair) | IRP051 | \$227.00 |
|------------------------|---------------|----------|

LOCKSAFE DRAWER SYSTEMS

| | | |
|------------------------|----------------|-----------|
| Twin Drawers - 1300mm | ITD1300 | \$1536.00 |
| Single Drawer - 1300mm | ISD1300 | \$932.00 |
| Wing Kit - 1300mm* | ITDW051 | \$367.00 |

*Designed to suit factory tubs, will not suit ute liner without modification.

SNORKEL

| | | |
|-------------------|---------------------|----------|
| 2.8L Turbo Diesel | ISNORKEL051 | \$437.00 |
| Narrow Body Model | ISNORKEL076N | \$437.00 |

LONG RANGE FUEL TANK

| | | |
|----------------------------------|----------------|-----------|
| 135L* - 2.8L Diesel 4WD Dual Cab | TANK051 | \$1180.00 |
|----------------------------------|----------------|-----------|

* Usable volume may differ to the stated tank capacity

PREMIUM UNDERBODY PROTECTION

| | | |
|-----------------------------|---------------|----------|
| Engine Bay and Transmission | UBP051 | \$782.00 |
|-----------------------------|---------------|----------|



Toyota Hilux

8/2020+

| Product Description | Part No. | Qty Req | Retail ea Inc GST |
|---|-------------------|------------|----------------------|
| CANOPY - PINNACLE SMOOTH FINISH FIBREGLASS (SIDE LIFT UP WINDOWS AND CENTRAL LOCKING REAR DOOR) - FITS 4X4 AND 4X2 DUAL CAB MODELS | | | |
| A DECK | | | |
| Super White (040) | CANFIBRE051-SW | | \$3763.00 |
| Silver Metallic / Silver Sky (1D6) | CANFIBRE051-SM | | \$3763.00 |
| Attitude Black (218) | CANFIBRE051-AB | | \$3763.00 |
| Dark Grey (1G3) | CANFIBRE051-DG | | \$3763.00 |
| • Fits A Deck 4x4 and 4x2 Dual Cab models | | | |
| CANOPY - PINNACLE 2 SMOOTH FINISH FIBREGLASS (SIDE LIFT UP WINDOWS AND CENTRAL LOCKING REAR DOOR) - FITS 4X4 AND 4X2 DUAL CAB MODELS | | | |
| A DECK | | | |
| Pre-Primed | ICANOPY051-P | | \$3213.00 |
| Super White (040) | ICANOPY051-SW | | \$3763.00 |
| Silver Metallic / Silver Sky (1D6) | ICANOPY051-SM | | \$3763.00 |
| Attitude Black (218) | ICANOPY051-AB | | \$3763.00 |
| Dark Grey (1G3) | ICANOPY051-DG | | \$3763.00 |
| * Pre-primed canopies, plus colour coding. | | | |
| SLIDE-AWAY ROLL UP HARD TONNEAU COVER | | | |
| Electric with Remote Control | ISLIDEAWAY051-E | | \$2716.00 |
| Sports Bar Adaptor (SR5 Sports Bar only) | ISLIDEAWAY051-SBA | | \$135.00 |
| • Suits A Deck models only | | | |
| ATLAS DUAL CAB ROOF RACK KITS | | | |
| Platform A with Blade Fit Kit (Dual Cab Only) - 1530mm Length | IFR065PAK | | \$1816.00 |
| Crossbar (x 2) and Fit Kit (Dual Cab) - 1250mm Width | IFR065C2K | | \$616.00 |
| Platform K with Leg Fit Kit to Suit Pinnacle 2 Canopy - 1390mm Length | IFRP2PKK | | \$1294.00 |
| Crossbar (x 2) and Fit Kit to Suit Pinnacle 2 Canopy - 1250mm Width | IFRP2C125K | | \$564.00 |
| Platform S with Blade Fit Kit to Suit Slideaway Hard Tonneau Cover - 1390mm Length | IFRSLDAWAYPSK | | \$1670.00 |
| Crossbar (x 2) and Fit Kit to Suit Slideaway Hard Tonneau Cover - 1500mm Width | IFRSLDAWAYC2K | | \$940.00 |
| • See Page 36 and 37 for more Atlas rack and crossbar options. | | | |
| FENDER FLARE KITS | | | |
| Matte Black Smooth Finish 6" (Suits Dual Cab) | IFF6076 | | \$499.00 |
| SEAT COVER | | | |
| Canvas Comfort - Front | ICSC051F | | \$420.00 |
| Canvas Comfort - Rear (Not compatible with WorkMate models) | ICSC051R | | \$420.00 |
| BREATHER KIT | | | |
| Universal Twin Manifold Filtered Breather Kit | IDIFFBRE | | \$115.00 |

 LISTING
CONTINUED
OVER THE
PAGE



Product Description

Part No.

Qty
Req

Retail
ea Inc GST

Please check vehicle date range (if shown) next to product description prior to ordering

SUSPENSION TO SUIT TOYOTA HILUX - 8/2020+

FRONT SUSPENSION

SHOCK ABSORBER

| | | | | | |
|-----------------------------------|--|--|----------------|---|----------|
| Nitro Gas Strut - Performance | | | 12730GR | 2 | \$232.00 |
| Foam Cell Strut - Performance | | | 24730FE | 2 | \$262.00 |
| Foam Cell Pro Strut - Performance | | | 45730FE | 2 | \$406.00 |

• Operating clearance to sway bar can be increased by installing 1210K offset sway bar bracket

COIL SPRINGS

| | Est. Lift | Additional Load | | | |
|---------------------------|-----------|-----------------|----------------|---|----------|
| Standard | 0mm | 0 - 50kg | TOY055A | 1 | \$262.00 |
| Light | 20mm | 0 - 50kg | TOY055B | 1 | \$262.00 |
| Light | 45mm | 0 - 50kg | TOY065A | 1 | \$262.00 |
| Medium | 30mm | 0 - 50kg | TOY055C | 1 | \$262.00 |
| Medium - with Accessories | 45mm | 0 - 50kg | TOY065B | 1 | \$262.00 |
| Heavy | 45mm | 50 - 110kg | TOY065C | 1 | \$262.00 |

STRUT MOUNTS

| | | | | | |
|-----------------|--|--|----------------|---|---------|
| Steel Strut Top | | | ISST001 | 2 | \$88.00 |
|-----------------|--|--|----------------|---|---------|

TRIM PACKERS

| | | | | |
|------------------------|-----------------------|-------------------------|---|---------|
| 5mm Strut Trim Packer | Nitro Gas / Foam Cell | HILFR05/HILFR05F | 2 | \$30.00 |
| 10mm Strut Trim Packer | Nitro Gas / Foam Cell | HILFR10/HILFR10F | 2 | \$30.00 |
| 15mm Strut Trim Packer | Nitro Gas / Foam Cell | HILFR15/HILFR15F | 2 | \$30.00 |

• ONLY Compatible with Ironman 4x4 Struts (except Pro), lift height subject to 2:1 motion ratio. Unnecessary fitment may lift vehicle too high

CONTROL ARMS

| | | | | | |
|------------------------------|--|--|-----------------|---|----------|
| Pro-Forge Upper Control Arms | | | UCA001FA | 1 | \$882.00 |
|------------------------------|--|--|-----------------|---|----------|

SWAY BAR

| | | | | | |
|-------------------------|--|--|---------------|---|----------|
| 33mm Sway Bar | | | ISB80F | 1 | \$609.00 |
| Offset Sway Bar Bracket | | | 1210K | 1 | \$146.00 |

REAR SUSPENSION

SHOCK ABSORBER

| | | | | | |
|------------------------------|--|--|-----------------|---|----------|
| Nitro Gas - Comfort | | | 12081GRC | 2 | \$160.00 |
| Nitro Gas - Performance | | | 12081GR | 2 | \$160.00 |
| Foam Cell - Comfort | | | 24081FEC | 2 | \$232.00 |
| Foam Cell - Performance | | | 24081FE | 2 | \$232.00 |
| Foam Cell - Professional | | | 24081FEP | 2 | \$232.00 |
| Foam Cell Pro - Comfort | | | 45081FEC | 2 | \$319.00 |
| Foam Cell Pro - Performance | | | 45081FE | 2 | \$319.00 |
| Foam Cell Pro - Professional | | | 45081FEP | 2 | \$319.00 |

LEAF SPRINGS

| | Est. Lift | Additional Load | | | |
|-------------|-----------|-----------------|----------------|---|----------|
| Light | 40mm | 0 - 100kg | TOY077A | 2 | \$392.00 |
| Medium | 45mm | 0 - 200kg | TOY077B | 2 | \$392.00 |
| Heavy | 45mm | 200 - 400kg | TOY077C | 2 | \$421.00 |
| Extra Heavy | 45mm | 400kg - GVM | TOY077D | 2 | \$421.00 |

• New spring pins 387-1 may be required, as OEM orientation may require cutting for removal

U-BOLTS

| | | | | | |
|------------|--|--|----------------|---|---------|
| U-Bolt Kit | | | 437UBKL | 2 | \$44.00 |
|------------|--|--|----------------|---|---------|

POLYURETHANE SPRING BUSHES

| | | | | | |
|----------|--|--|--------------|---|---------|
| Bush Kit | | | 767UK | 1 | \$88.00 |
|----------|--|--|--------------|---|---------|

SPACER KIT

| | | | | | |
|---|--|--|--------------|---|---------|
| Centre Bearing Spacer Kit | | | 1192K | 1 | \$30.00 |
| Headlight Adjustment Leaf Spring Bracket (SR5 Only) | | | 1213K | 1 | \$19.00 |

GREASABLE SHACKLES AND PINS

| | | | | | |
|-------------------|--|--|--------------|---|---------|
| Greasable Shackle | | | 1155 | 2 | \$59.00 |
| Non-Greasable Pin | | | 387-1 | 2 | \$30.00 |

HELPER SPRINGS

| | | | | | |
|--------------------------|--|--|----------------|---|----------|
| Load Plus Helper Springs | | | LP2 | 1 | \$165.00 |
| Add-A-Leaf | | | ISL6010 | 1 | \$175.00 |



8/2020+

Toyota Hilux

Product Description

Part No.

**Qty
Req**

**Retail
ea Inc GST**

Please check vehicle date range (if shown) next to product description prior to ordering

SUSPENSION KIT - Specify Front Coil Springs When Ordering

| | | |
|-----------------------------|------------------|-----------|
| Light - Nitro Gas | TOY077AKG | \$2056.00 |
| Light - Foam Cell | TOY077AKF | \$2259.00 |
| Light - Foam Cell Pro | TOY077AKP | \$2867.00 |
| Medium - Nitro Gas | TOY077BKG | \$2056.00 |
| Medium - Foam Cell | TOY077BKF | \$2259.00 |
| Medium - Foam Cell Pro | TOY077BKP | \$2867.00 |
| Heavy - Nitro Gas | TOY077CKG | \$2115.00 |
| Heavy - Foam Cell | TOY077CKF | \$2317.00 |
| Heavy - Foam Cell Pro | TOY077CKP | \$2925.00 |
| Extra Heavy - Nitro Gas | TOY077DKG | \$2115.00 |
| Extra Heavy - Foam Cell | TOY077DKF | \$2317.00 |
| Extra Heavy - Foam Cell Pro | TOY077DKP | \$2925.00 |

SUSPENSION KIT CONTENTS

| | | | |
|-----------------------|--------------|----------------------------|---|
| Shock Absorbers | Coil Springs | U-Bolts | Non-Greasable Pins |
| Strut Shock Absorbers | Leaf Springs | Polyurethane Spring Bushes | Offset Sway Bar Bracket (Pro Kits Only) |



OPTIONS AVAILABLE FOR THIS VEHICLE - SEE PAGE 385



Product Description

Part No.

Qty
Req

Retail
ea Inc GST

Please check vehicle date range (if shown) next to product description prior to ordering

ACCESSORIES TO SUIT TOYOTA HILUX - 2015-7/2020

STEEL WINCH BULL BARS SUITS

| | | |
|--|--------------------|-----------|
| Commercial - (2015 to 4/2018 Only) * | BBC051 * | \$1754.00 |
| Commercial - (5/2018 to 7/2020 Only) * | BB065 * | \$1754.00 |
| Commercial Deluxe - (2015 to 4/2018 Only) * | BB065 * | \$2387.00 |
| Commercial Deluxe - (5/2018 to 7/2020 Only) * | BB065 * | \$2387.00 |
| Polished Alloy - (2015 to 4/2018 Only) * | BBA051 * | \$2472.00 |
| Polished Alloy - (5/2018 to 7/2020 Only) * | BBA065 * | \$2472.00 |
| Proguard No Loop - (2015 to 4/2018 Only) * | BBT051-NL * | \$1973.00 |
| Proguard No Loop - (5/2018 to 7/2020 Only) * | BBT065-NL * | \$1973.00 |
| Proguard Single Loop Kit - (2015 to 4/2018 Only) * | BB051-SL * | \$352.00 |
| Proguard Single Loop Kit - (5/2018 to 7/2020 Only) * | BB065-SL * | \$352.00 |
| Proguard Triple Loop Kit - (2015 to 4/2018 Only) * | BB051-TL * | \$423.00 |
| Proguard Triple Loop Kit - (5/2018 to 7/2020 Only) * | BB065-TL * | \$423.00 |

* Winch with Steel Cable and Roller Fairlead is not suitable - Use Winch with Synthetic Rope and Alloy Hawse only

* Suits wide body models only - Hi-Rider - 4x2 SR & SR5 / Dual Cab 4x4 - Workmate, SR & SR5 / Extra Cab 4x4 - Workmate, SR & SR5

STEEL SIDE STEPS AND RAILS

| | | |
|--|-------------------|-----------|
| Side Steps - Fits Dual Cab models only | SS051 | \$1006.00 |
| Side Rails | SS051 RAIL | \$332.00 |
| Side Steps and Rails - Fits Dual Cab models only | SSR051 | \$1207.00 |

TOWING

| | | |
|--|--------------------|-----------|
| Class 4 Towbar - Compatible with Factory Rear Bumper | TB051 | \$608.00 |
| Rear Protection Towbar - Full Rear Bumper Replacement* - With Side Tubes | RTB051-SP | \$1388.00 |
| Rear Protection Towbar Plates (Pair) | RTBPLATE001 | \$153.00 |
| Towbar Wiring Loom - Plug and Play | ITBL051 | \$289.00 |

RECOVERY POINTS - IRONMAN 4X4 BULL BAR ONLY

| | | |
|--|---------------|----------|
| Recovery Points - 5000kg Rating (Pair) | IRP051 | \$227.00 |
|--|---------------|----------|

LOCKSAFE DRAWER SYSTEMS

| | | |
|------------------------|----------------|-----------|
| Twin Drawers - 1300mm | ITD1300 | \$1536.00 |
| Single Drawer - 1300mm | ISD1300 | \$932.00 |
| Wing Kit - 1300mm* | ITDW051 | \$367.00 |

* Designed to suit factory tubs, will not suit ute liner without modification.

SNORKEL

| | | |
|-------------------|--------------------|----------|
| 2.8L Turbo Diesel | ISNORKEL051 | \$437.00 |
|-------------------|--------------------|----------|

LONG RANGE FUEL TANK

| | | |
|-------------------------|----------------|-----------|
| 135L* - 2.8L Diesel 4WD | TANK051 | \$1180.00 |
|-------------------------|----------------|-----------|

* Usable volume may differ to the stated tank capacity

PREMIUM UNDERBODY PROTECTION

| | | |
|-----------------------------|---------------|----------|
| Engine Bay and Transmission | UBP051 | \$782.00 |
|-----------------------------|---------------|----------|

Revo
2015 to 4/2018
(Facelift) 5/2018 to 7/2020



| Product Description | Part No. | Qty Req | Retail ea Inc GST |
|---|-------------------|------------|----------------------|
| Please check vehicle date range (if shown) next to product description prior to ordering | | | |
| CANOPY - ABS PLASTIC (SIDE LIFT UP WINDOWS AND CENTRAL LOCKING REAR DOOR) - FITS 4X4 AND 4X2 DUAL CAB MODELS | | | |
| J DECK | | | |
| Super White (040) | CANOPY017-SW | | \$3856.00 |
| ABS Canopy Rack Feet | IRRFETABS14 | | \$287.00 |
| • See Page 38 for 1.4m Roof Rack options and pricing. | | | |
| CANOPY - PINNACLE SMOOTH FINISH FIBREGLASS (SIDE LIFT UP WINDOWS AND CENTRAL LOCKING REAR DOOR) - FITS 4X4 AND 4X2 DUAL CAB MODELS | | | |
| A DECK | | | |
| Super White (040) | CANFIBRE051-SW | | \$3763.00 |
| Silver Metallic / Silver Sky (1D6) | CANFIBRE051-SM | | \$3763.00 |
| Attitude Black (218) | CANFIBRE051-AB | | \$3763.00 |
| Dark Grey (1G3) | CANFIBRE051-DG | | \$3763.00 |
| • Fits A Deck 4x4 and 4x2 Dual Cab models | | | |
| CANOPY - PINNACLE 2 SMOOTH FINISH FIBREGLASS (SIDE LIFT UP WINDOWS AND CENTRAL LOCKING REAR DOOR) - FITS 4X4 AND 4X2 DUAL CAB MODELS | | | |
| A DECK | | | |
| Pre-Primed | ICANOPY051-P | | \$3213.00 |
| Super White (040) | ICANOPY051-SW | | \$3763.00 |
| Silver Metallic / Silver Sky (1D6) | ICANOPY051-SM | | \$3763.00 |
| Attitude Black (218) | ICANOPY051-AB | | \$3763.00 |
| Dark Grey (1G3) | ICANOPY051-DG | | \$3763.00 |
| * Pre-primed canopies, plus colour coding. | | | |
| SLIDE-AWAY ROLL UP HARD TONNEAU COVER | | | |
| Electric with Remote Control | ISLIDEAWAY051-E | | \$2716.00 |
| Sports Bar Adaptor | ISLIDEAWAY051-SBA | | \$135.00 |
| • Suits A Deck models only | | | |
| ATLAS DUAL CAB ROOF RACK KITS | | | |
| Platform A with Blade Fit Kit (Dual Cab Only) - 1530mm Length | IFR065PAK | | \$1816.00 |
| Crossbar (x 2) and Fit Kit (Dual Cab) - 1250mm Width | IFR065C2K | | \$616.00 |
| Platform K with Leg Fit Kit to Suit Pinnacle 2 Canopy - 1390mm Length | IFRP2PKK | | \$1294.00 |
| Crossbar (x 2) and Fit Kit to Suit Pinnacle 2 Canopy - 1250mm Width | IFRP2C125K | | \$564.00 |
| Platform S with Blade Fit Kit to Suit Slideaway Hard Tonneau Cover - 1390mm Length | IFRSLDAWAYPSK | | \$1670.00 |
| Crossbar (x 2) and Fit Kit to Suit Slideaway Hard Tonneau Cover - 1500mm Width | IFRSLDAWAYC2K | | \$940.00 |
| • See Page 36 and 37 for more Atlas rack and crossbar options. | | | |
| FENDER FLARE KITS | | | |
| Matte Black Smooth Finish 6" (Suits Dual Cab) | IFF6051 | | \$499.00 |
| SEAT COVER | | | |
| Canvas Comfort - Front | ICSC051F | | \$420.00 |
| Canvas Comfort - Rear | ICSC051R | | \$420.00 |
| BREATHER KIT | | | |
| Universal Twin Manifold Filtered Breather Kit | IDIFFBRE | | \$115.00 |

LISTING
CONTINUED
OVER THE
PAGE



Product Description

Part No.

Qty
Req

Retail
ea Inc GST

Please check vehicle date range (if shown) next to product description prior to ordering

SUSPENSION TO SUIT TOYOTA HILUX - 2015-7/2020

FRONT SUSPENSION

SHOCK ABSORBER

| | | | | | |
|-----------------------------------|--|--|----------------|---|----------|
| Nitro Gas Strut - Performance | | | 12730GR | 2 | \$232.00 |
| Foam Cell Strut - Performance | | | 24730FE | 2 | \$262.00 |
| Foam Cell Pro Strut - Performance | | | 45730FE | 2 | \$406.00 |

• Operating clearance to sway bar can be increased by installing 1210K offset sway bar bracket

COIL SPRINGS

| | Est. Lift | Additional Load | | | |
|---------------------------|-----------|-----------------|----------------|---|----------|
| Standard | 0mm | 0 - 50kg | TOY055A | 1 | \$262.00 |
| Light | 20mm | 0 - 50kg | TOY055B | 1 | \$262.00 |
| Light | 45mm | 0 - 50kg | TOY065A | 1 | \$262.00 |
| Medium | 30mm | 0 - 50kg | TOY055C | 1 | \$262.00 |
| Medium - with Accessories | 45mm | 0 - 50kg | TOY065B | 1 | \$262.00 |
| Heavy | 45mm | 50 - 110kg | TOY065C | 1 | \$262.00 |

STRUT MOUNTS

| | | | | | |
|-----------------|--|--|----------------|---|---------|
| Steel Strut Top | | | ISST001 | 2 | \$88.00 |
|-----------------|--|--|----------------|---|---------|

TRIM PACKERS

| | | | | |
|------------------------|-----------------------|-------------------------|---|---------|
| 5mm Strut Trim Packer | Nitro Gas / Foam Cell | HILFR05/HILFR05F | 2 | \$30.00 |
| 10mm Strut Trim Packer | Nitro Gas / Foam Cell | HILFR10/HILFR10F | 2 | \$30.00 |
| 15mm Strut Trim Packer | Nitro Gas / Foam Cell | HILFR15/HILFR15F | 2 | \$30.00 |

• ONLY Compatible with Ironman 4x4 Struts (except Pro), lift height subject to 2:1 motion ratio. Unnecessary fitment may lift vehicle too high

CONTROL ARMS

| | | | | | |
|------------------------------|--|--|-----------------|---|----------|
| Pro-Forge Upper Control Arms | | | UCA001FA | 1 | \$882.00 |
|------------------------------|--|--|-----------------|---|----------|

SWAY BAR

| | | | | | |
|-------------------------|--|--|---------------|---|----------|
| 33mm Sway Bar | | | ISB80F | 1 | \$609.00 |
| Offset Sway Bar Bracket | | | 1210K | 1 | \$146.00 |

REAR SUSPENSION

SHOCK ABSORBER

| | | | | | |
|------------------------------|--|--|-----------------|---|----------|
| Nitro Gas - Comfort | | | 12081GRC | 2 | \$160.00 |
| Nitro Gas - Performance | | | 12081GR | 2 | \$160.00 |
| Foam Cell - Comfort | | | 24081FEC | 2 | \$232.00 |
| Foam Cell - Performance | | | 24081FE | 2 | \$232.00 |
| Foam Cell - Professional | | | 24081FEP | 2 | \$232.00 |
| Foam Cell Pro - Comfort | | | 45081FEC | 2 | \$319.00 |
| Foam Cell Pro - Performance | | | 45081FE | 2 | \$319.00 |
| Foam Cell Pro - Professional | | | 45081FEP | 2 | \$319.00 |

LEAF SPRINGS

| | Est. Lift | Additional Load | | | |
|-------------|-----------|-----------------|----------------|---|----------|
| Light | 40mm | 0 - 100kg | TOY077A | 2 | \$392.00 |
| Medium | 45mm | 0 - 200kg | TOY077B | 2 | \$392.00 |
| Heavy | 45mm | 200 - 400kg | TOY077C | 2 | \$421.00 |
| Extra Heavy | 45mm | 400kg - GVM | TOY077D | 2 | \$421.00 |

• New spring pins 387-1 may be required, as OEM orientation may require cutting for removal

U-BOLTS

| | | | | | |
|------------|--|--|----------------|---|---------|
| U-Bolt Kit | | | 437UBKL | 2 | \$44.00 |
|------------|--|--|----------------|---|---------|

POLYURETHANE SPRING BUSHES

| | | | | | |
|----------|--|--|--------------|---|---------|
| Bush Kit | | | 767UK | 1 | \$88.00 |
|----------|--|--|--------------|---|---------|

SPACER KIT

| | | | | | |
|---|--|--|--------------|---|---------|
| Centre Bearing Spacer Kit | | | 1192K | 1 | \$30.00 |
| Headlight Adjustment Leaf Spring Bracket (SR5 Only) | | | 1213K | 1 | \$19.00 |

GREASABLE SHACKLES AND PINS

| | | | | | |
|-------------------|--|--|--------------|---|---------|
| Greasable Shackle | | | 1155 | 2 | \$59.00 |
| Non-Greasable Pin | | | 387-1 | 2 | \$30.00 |

HELPER SPRINGS

| | | | | | |
|--------------------------|--|--|----------------|---|----------|
| Load Plus Helper Springs | | | LP2 | 1 | \$165.00 |
| Add-A-Leaf | | | ISL6010 | 1 | \$175.00 |



Revo
2015 to 4/2018
(Facelift) 5/2018 to 7/2020

SUSPENSION TO SUIT

Toyota Hilux

Product Description

Part No.

Qty
Req

Retail
ea Inc GST

Please check vehicle date range (if shown) next to product description prior to ordering

SUSPENSION KIT - Specify Front Coil Springs When Ordering

| | | |
|-----------------------------|-----------|-----------|
| Light - Nitro Gas | TOY077AKG | \$2056.00 |
| Light - Foam Cell | TOY077AKF | \$2259.00 |
| Light - Foam Cell Pro | TOY077AKP | \$2867.00 |
| Medium - Nitro Gas | TOY077BKG | \$2056.00 |
| Medium - Foam Cell | TOY077BKF | \$2259.00 |
| Medium - Foam Cell Pro | TOY077BKP | \$2867.00 |
| Heavy - Nitro Gas | TOY077CKG | \$2115.00 |
| Heavy - Foam Cell | TOY077CKF | \$2317.00 |
| Heavy - Foam Cell Pro | TOY077CKP | \$2925.00 |
| Extra Heavy - Nitro Gas | TOY077DKG | \$2115.00 |
| Extra Heavy - Foam Cell | TOY077DKF | \$2317.00 |
| Extra Heavy - Foam Cell Pro | TOY077DKP | \$2925.00 |

SUSPENSION KIT CONTENTS

| | | | |
|-----------------------|--------------|----------------------------|---|
| Shock Absorbers | Coil Springs | U-Bolts | Non-Greasable Pins |
| Strut Shock Absorbers | Leaf Springs | Polyurethane Spring Bushes | Offset Sway Bar Bracket (Pro Kits Only) |



OPTIONS AVAILABLE FOR THIS VEHICLE - SEE PAGE 385

Toyota Hilux

Vigo
3/2005 to 9/2011
(Facelift) 10/2011 to 2015



Product Description

Part No.

Qty
ReqRetail
ea Inc GST

Please check vehicle date range (if shown) next to product description prior to ordering

ACCESSORIES TO SUIT TOYOTA HILUX - 3/2005-2015

STEEL WINCH BULL BARS

| | | |
|---|---------|-----------|
| Commercial - (3/2005 to 9/2011 Only) | BBC002 | \$1723.00 |
| Commercial - (10/2011 to 2015 Only) | BBC033 | \$1723.00 |
| Commercial Deluxe - (3/2005 to 9/2011 Only) | BBCD002 | \$2345.00 |
| Commercial Deluxe - (10/2011 to 2015 Only) | BBCD033 | \$2345.00 |
| Protector - (10/2011 to 2015 Only) - <i>While Stocks Last</i> | BBT033 | \$2271.00 |

STEEL SIDE STEPS AND RAILS

| | | |
|--|--------|-----------|
| Side Steps - Fits Dual Cab models only | SS033 | \$1006.00 |
| Side Steps and Rails - Fits Dual Cab models only | SSR033 | \$1207.00 |

RECOVERY POINTS - IRONMAN 4X4 BULL BAR ONLY

| | | |
|--|--------|----------|
| Recovery Points - 5000kg Rating (Pair) | IRP033 | \$227.00 |
|--|--------|----------|

LOCKSAFE DRAWER SYSTEMS

| | | |
|------------------------|---------|-----------|
| Twin Drawers - 1300mm | ITD1300 | \$1536.00 |
| Single Drawer - 1300mm | ISD1300 | \$932.00 |
| Wing Kit - 1300mm* | ITDW024 | \$367.00 |

*Designed to suit factory tubs, will not suit ute liner without modification.

SNORKEL

| | | |
|---------------------------|-------------|----------|
| 3L D4D TDi / 4L Petrol V6 | ISNORKEL001 | \$437.00 |
|---------------------------|-------------|----------|

LONG RANGE FUEL TANK

| | | |
|------------------------------------|---------|-----------|
| 145L* - Diesel and Petrol 4WD only | TANK002 | \$1180.00 |
|------------------------------------|---------|-----------|

*Usable volume may differ to the stated tank capacity

PREMIUM UNDERBODY PROTECTION

| | | |
|-----------------------------|--------|----------|
| Engine Bay and Transmission | UBP033 | \$782.00 |
|-----------------------------|--------|----------|

UNDERBODY PROTECTION

| | | |
|--|---------|----------|
| Engine Bay and Transmission - <i>While Stocks Last</i> | IUP001K | \$563.00 |
|--|---------|----------|

FENDER FLARE KITS

| | | |
|--|---------|----------|
| Matte Black Smooth Finish 6" (Suits 3/2005 T 9/2011 Dual Cab Only) | IFF6002 | \$499.00 |
| Matte Black Smooth Finish 6" (Suits 10/2011 to 2015 Dual Cab Only) | IFF6002 | \$499.00 |

SEAT COVER

| | | |
|------------------------|----------|----------|
| Canvas Comfort - Front | ICSC033F | \$420.00 |
| Canvas Comfort - Rear | ICSC033R | \$420.00 |

BREATHER KIT

| | | |
|---|----------|----------|
| Universal Twin Manifold Filtered Breather Kit | IDIFFBRE | \$115.00 |
|---|----------|----------|



Vigo
3/2005 to 9/2011
(Facelift) 10/2011 to 2015

Product Description

Part No.

**Qty
Req**

**Retail
ea Inc GST**

Please check vehicle date range (if shown) next to product description prior to ordering

SUSPENSION TO SUIT TOYOTA HILUX - 3/2005-2015

FRONT SUSPENSION

SHOCK ABSORBER

| | | | | | |
|-----------------------------------|--|--|----------------|---|----------|
| Nitro Gas Strut - Performance | | | 12710GR | 2 | \$232.00 |
| Foam Cell Strut - Performance | | | 24710FE | 2 | \$262.00 |
| Foam Cell Pro Strut - Performance | | | 45710FE | 2 | \$406.00 |

• Foam Cell Pro, must fit 1198K spacer for Sway Bar clearance

COIL SPRINGS

| | Est. Lift | Additional Load | | | |
|--------|-----------|-----------------|----------------|---|----------|
| Light | 40mm | 0 - 50kg | TOY055A | 1 | \$262.00 |
| Medium | 45mm | 0 - 50kg | TOY055B | 1 | \$262.00 |
| Heavy | 45mm | 50 - 110kg | TOY055C | 1 | \$262.00 |

STRUT MOUNTS

| | | | | | |
|-----------------|--|--|----------------|---|---------|
| Steel Strut Top | | | ISST001 | 2 | \$88.00 |
|-----------------|--|--|----------------|---|---------|

TRIM PACKERS

| | | | | |
|------------------------|-----------------------|-------------------------|---|---------|
| 5mm Strut Trim Packer | Nitro Gas / Foam Cell | HILFR05/HILFR05F | 2 | \$30.00 |
| 10mm Strut Trim Packer | Nitro Gas / Foam Cell | HILFR10/HILFR10F | 2 | \$30.00 |
| 15mm Strut Trim Packer | Nitro Gas / Foam Cell | HILFR15/HILFR15F | 2 | \$30.00 |

• ONLY Compatible with Ironman 4x4 Struts (except Pro), lift height subject to 2:1 motion ratio. Unnecessary fitment may lift vehicle too high

CONTROL ARMS

| | | | | | |
|------------------------------|--|--|-----------------|---|----------|
| Pro-Forge Upper Control Arms | | | UCA001FA | 1 | \$882.00 |
|------------------------------|--|--|-----------------|---|----------|

SPACER KIT

| | | | | | |
|-----------------|--|--|--------------|---|----------|
| Sway Bar Spacer | | | 1198K | 1 | \$102.00 |
|-----------------|--|--|--------------|---|----------|

REAR SUSPENSION

SHOCK ABSORBER

| | | | | | |
|---|--|--|-----------------|---|----------|
| Nitro Gas - Comfort | | | 12650GRC | 2 | \$160.00 |
| Nitro Gas - Performance | | | 12650GR | 2 | \$160.00 |
| Nitro Gas Extra Long - Comfort | | | 12081GRC | 2 | \$160.00 |
| Nitro Gas Extra Long - Performance | | | 12081GR | 2 | \$160.00 |
| Foam Cell - Comfort | | | 24650FEC | 2 | \$232.00 |
| Foam Cell - Performance | | | 24650FE | 2 | \$232.00 |
| Foam Cell Extra Long - Comfort | | | 24081FEC | 2 | \$232.00 |
| Foam Cell Extra Long - Performance | | | 24081FE | 2 | \$232.00 |
| Foam Cell Extra Long - Professional | | | 24081FEP | 2 | \$232.00 |
| Foam Cell Pro - Comfort | | | 45650FEC | 2 | \$319.00 |
| Foam Cell Pro - Performance | | | 45650FE | 2 | \$319.00 |
| Foam Cell Pro Extra Long - Comfort | | | 45081FEC | 2 | \$319.00 |
| Foam Cell Pro Extra Long - Performance | | | 45081FE | 2 | \$319.00 |
| Foam Cell Pro Extra Long - Professional | | | 45081FEP | 2 | \$319.00 |

LEAF SPRINGS

| | Est. Lift | Additional Load | | | |
|-------------|-----------|-----------------|----------------|---|----------|
| Light | 45mm | 0 - 100kg | TOY057A | 2 | \$392.00 |
| Medium | 45mm | 0 - 200kg | TOY057B | 2 | \$392.00 |
| Heavy | 45mm | 200 - 400kg | TOY057C | 2 | \$421.00 |
| Extra Heavy | 45mm | 400kg - GVM | TOY057D | 2 | \$421.00 |

U-BOLTS

| | | | | | |
|-----------------------|----------------------------------|--|----------------|---|---------|
| U-Bolt Kit | | | 437UBK | 2 | \$44.00 |
| U-Bolt Kit Extra long | Suits TOY057A and TOY057D Spring | | 437UBKL | 2 | \$44.00 |

POLYURETHANE SPRING BUSHES

| | | | | | |
|----------|--|--|--------------|---|---------|
| Bush Kit | | | 767UK | 1 | \$88.00 |
|----------|--|--|--------------|---|---------|

GREASABLE SHACKLES AND PINS

| | | | | | |
|-------------------|--|--|--------------|---|---------|
| Greasable Shackle | | | 386-3 | 2 | \$59.00 |
| Non-Greasable Pin | | | 387-1 | 2 | \$30.00 |

HELPER SPRINGS

| | | | | | |
|--------------------------|--|--|----------------|---|----------|
| Load Plus Helper Springs | | | LP2 | 1 | \$165.00 |
| Add-A-Leaf | | | ISL6010 | 1 | \$175.00 |

**LISTING
CONTINUED
OVER THE
PAGE**



Toyota Hilux

Vigo
3/2005 to 9/2011
(Facelift) 10/2011 to 2015



Product Description

Part No.

**Qty
Req**

**Retail
ea Inc GST**

Please check vehicle date range (if shown) next to product description prior to ordering

SUSPENSION KIT - Specify Front Coil Springs When Ordering

| | | |
|-----------------------------|-----------|-----------|
| Light - Nitro Gas | TOY057AKG | \$1999.00 |
| Light - Foam Cell | TOY057AKF | \$2201.00 |
| Light - Foam Cell Pro | TOY057AKP | \$2766.00 |
| Medium - Nitro Gas | TOY057BKG | \$1999.00 |
| Medium - Foam Cell | TOY057BKF | \$2201.00 |
| Medium - Foam Cell Pro | TOY057BKP | \$2766.00 |
| Heavy - Nitro Gas | TOY057CKG | \$2056.00 |
| Heavy - Foam Cell | TOY057CKF | \$2259.00 |
| Heavy - Foam Cell Pro | TOY057CKP | \$2824.00 |
| Extra Heavy - Nitro Gas | TOY057DKG | \$2056.00 |
| Extra Heavy - Foam Cell | TOY057DKF | \$2259.00 |
| Extra Heavy - Foam Cell Pro | TOY057DKP | \$2824.00 |

SUSPENSION KIT CONTENTS

| | | |
|-----------------------|--------------|----------------------------|
| Shock Absorbers | Coil Springs | U-Bolts |
| Strut Shock Absorbers | Leaf Springs | Polyurethane Spring Bushes |



OPTIONS AVAILABLE FOR THIS VEHICLE - SEE PAGE 386

Toyota Hilux



Low Ride 2WD
2005+

Product Description

Part No.

Qty
ReqRetail
ea Inc GST

Please check vehicle date range (if shown) next to product description prior to ordering

SUSPENSION TO SUIT TOYOTA HILUX - 2005+

FRONT SUSPENSION

SHOCK ABSORBER

| | | | | |
|-------------------------------|-----------------|------------------|---|----------|
| Nitro Gas Strut - Performance | Left Hand Side | 12764GRLH | 1 | \$232.00 |
| Nitro Gas Strut - Performance | Right Hand Side | 12764GRRH | 1 | \$232.00 |

COIL SPRINGS

| | Est. Lift | Additional Load | | | |
|--------|-----------|-----------------|----------------|---|----------|
| Medium | 40mm | 0 -50kg | TOY067B | 1 | \$262.00 |

TRIM PACKERS

| | | | | |
|------------------------|-----------|----------------|---|---------|
| 5mm Strut Trim Packer | Nitro Gas | HILFR05 | 2 | \$30.00 |
| 10mm Strut Trim Packer | Nitro Gas | HILFR10 | 2 | \$30.00 |
| 15mm Strut Trim Packer | Nitro Gas | HILFR15 | 2 | \$30.00 |

• Only compatible with Ironman 4x4 Struts, lift height subject to 2:1 motion ratio. Unnecessary fitment may lift vehicle too high

REAR SUSPENSION

SHOCK ABSORBER

| | | | | |
|--------------------------|--|-----------------|---|----------|
| Nitro Gas - Comfort | | 12650GRC | 2 | \$160.00 |
| Nitro Gas - Performance | | 12650GR | 2 | \$160.00 |
| Foam Cell - Comfort | | 24650FEC | 2 | \$232.00 |
| Foam Cell - Performance | | 24650FE | 2 | \$232.00 |
| Foam Cell - Professional | | 24650FEP | 2 | \$232.00 |

LEAF SPRINGS

| | Est. Lift | Additional Load | | | |
|--------|-----------|-----------------|----------------|---|----------|
| Medium | 45mm | 0 -200kg | TOY068B | 2 | \$392.00 |
| Heavy | 45mm | 200 - 400kg | TOY068C | 2 | \$421.00 |

U-BOLTS

| | | | | |
|------------|--|---------------|---|---------|
| U-Bolt Kit | | 415UBK | 2 | \$44.00 |
|------------|--|---------------|---|---------|

POLYURETHANE SPRING BUSHES

| | | | | |
|----------|----------------------------------|---------------|---|---------|
| Bush Kit | (14mm Front Bolt) | 767UK | 1 | \$88.00 |
| Bush Kit | (23mm Front Pin with Side Plate) | 1151UK | 1 | \$88.00 |

GREASABLE SHACKLES AND PINS

| | | | | |
|-------------------|--|--------------|---|---------|
| Greasable Shackle | | 386-3 | 2 | \$59.00 |
| Non-Greasable Pin | | 387-1 | 2 | \$30.00 |

• 14mm Pin

HELPER SPRINGS

| | | | | |
|--------------------------|--|----------------|---|----------|
| Load Plus Helper Springs | | LP2 | 1 | \$165.00 |
| Add-A-Leaf | | ISL6010 | 1 | \$175.00 |

SUSPENSION KIT

| | | |
|--------------------|------------------|-----------|
| Medium - Nitro Gas | TOY068BKG | \$1999.00 |
| Heavy - Nitro Gas | TOY068CKG | \$2056.00 |

• Specify Leaf Springs front bush I/D before ordering

SUSPENSION KIT CONTENTS

Shock Absorbers
Leaf Springs

Torsion Bars
U-Bolts

Polyurethane Spring Bushes

Toyota Hilux

Tiger 107, 108, 110, 111, 167
1997 to 2004



Product Description

Part No.

Qty
Req

Retail
ea Inc GST

Please check vehicle date range (if shown) next to product description prior to ordering

ACCESSORIES TO SUIT TOYOTA HILUX - 1997-2004

STEEL WINCH BULL BARS

Commercial Deluxe - (2001 to 2004 Only)

BBCD001

\$2345.00

LOCKSAFE DRAWER SYSTEMS

Twin Drawers - 1300mm

ITD1300

\$1536.00

Single Drawer - 1300mm

ISD1300

\$932.00

Wing Kit - 1300mm (SR-SR5)*

ITDW023

\$367.00

*Designed to suit factory tubs, will not suit ute liner without modification.

BREATHER KIT

Universal Twin Manifold Filtered Breather Kit

IDIFFBRE

\$115.00

SUSPENSION TO SUIT TOYOTA HILUX - 1997-2004

FRONT SUSPENSION

SHOCK ABSORBER

Nitro Gas - Performance

12088GR

2

\$160.00

Foam Cell - Performance

24088FE

2

\$232.00

TORSION BAR

Up-rated Torsion Bars

TOY026

1

\$435.00

• Minimum 60mm downward suspension travel required after adjustment

STEERING DAMPER

Foam Cell

3533

1

\$175.00

• Check clearance to engine sump when fitting steering damper

REAR SUSPENSION

SHOCK ABSORBER

Nitro Gas - Comfort

12081GRC

2

\$160.00

Nitro Gas - Performance

12081GR

2

\$160.00

Foam Cell - Comfort

24081FEC

2

\$232.00

Foam Cell - Performance

24081FE

2

\$232.00

Foam Cell - Professional

24081FEP

2

\$232.00

LEAF SPRINGS

Light

Est. Lift

Additional Load

TOY027A

2

\$392.00

Medium

40mm

0-100kg

TOY027B

2

\$392.00

Heavy

40mm

200kg - GVM

TOY027C

2

\$421.00

• 1300mm Leaf Length

U-BOLTS

U-Bolt Kit

437UBK

2

\$44.00

U-Bolt Kit Extra long

Suits TOY027A Spring

437UBKL

2

\$44.00

POLYURETHANE SPRING BUSHES

Bush Kit

758UK

1

\$88.00

GREASABLE SHACKLES AND PINS

Greasable Shackle

Stepped Shackle

386-1

2

\$59.00

Non-Greasable Pin

387-1

2

\$30.00

HELPER SPRINGS

Load Plus Helper Springs

LP2

1

\$165.00

Add-A-Leaf

ISL6010

1

\$175.00

SUSPENSION KIT

Light - Nitro Gas

TOY027AKG

\$2028.00

Light - Foam Cell

TOY027AKF

\$2317.00

Medium - Nitro Gas

TOY027BKG

\$2028.00

Medium - Foam Cell

TOY027BKF

\$2317.00

Heavy - Nitro Gas

TOY027CKG

\$2085.00

Heavy - Foam Cell

TOY027CKF

\$2375.00

SUSPENSION KIT CONTENTS

Shock Absorbers

Torsion Bars

Polyurethane Spring Bushes

Leaf Springs

U-Bolts

Toyota Hilux

Solid Front Axle
11/1983 to 11/1997

Product Description

Part No.

Qty
ReqRetail
ea Inc GST*Please check vehicle date range (if shown) next to product description prior to ordering***SUSPENSION TO SUIT TOYOTA HILUX - 11/1983-11/1997****FRONT SUSPENSION****SHOCK ABSORBER**

| | | | | | |
|-------------------------|--|--|-----------------|---|----------|
| Nitro Gas - Comfort | | | 12639GRC | 2 | \$160.00 |
| Nitro Gas - Performance | | | 12639GR | 2 | \$160.00 |
| Foam Cell - Performance | | | 24639FE | 2 | \$232.00 |

LEAF SPRINGS

| | Est. Lift | Additional Load | | | |
|--------------------------------|-----------|-----------------|-------------------|---|----------|
| Medium - Drivers Side (Petrol) | 50mm | 0 - 50kg | TOY010BD/S | 1 | \$218.00 |
| Medium - Near Side (Petrol) | 50mm | 0 - 50kg | TOY010BN/S | 1 | \$218.00 |
| Heavy - Drivers Side (Diesel) | 50mm | 0 - 100kg | TOY010CD/S | 1 | \$218.00 |
| Heavy - Near Side (Diesel) | 50mm | 0 - 100kg | TOY010CN/S | 1 | \$218.00 |

• Check clearance to drag link / u-bolt, ADL106 may be required

STEERING DAMPER

| | | | | | |
|-----------|--|--|-------------|---|----------|
| Foam Cell | | | 3521 | 1 | \$175.00 |
|-----------|--|--|-------------|---|----------|

U-BOLTS

| | | | | | |
|-------------------------|--|--|---------------|---|---------|
| Drivers Side U-Bolt Kit | | | 678UBK | 1 | \$44.00 |
| Near Side U-Bolt Kit | | | 437UBK | 1 | \$44.00 |

POLYURETHANE SPRING BUSHES

| | | | | | |
|----------|--|--|--------------|---|---------|
| Bush Kit | | | 732UK | 1 | \$74.00 |
|----------|--|--|--------------|---|---------|

STEERING ARMS

| | | | | | |
|----------------|--|--|---------------|---|----------|
| Drop Drag Link | | | ADL106 | 1 | \$291.00 |
|----------------|--|--|---------------|---|----------|

GREASABLE SHACKLES AND PINS

| | | | | | |
|-------------------|--|--|------------|---|---------|
| Greasable Shackle | | | 384 | 2 | \$74.00 |
| Greasable Pin | | | 385 | 2 | \$44.00 |

REAR SUSPENSION**SHOCK ABSORBER**

| | | | | | |
|--------------------------|--|--|-----------------|---|----------|
| Nitro Gas - Comfort | | | 12650GRC | 2 | \$160.00 |
| Nitro Gas - Performance | | | 12650GR | 2 | \$160.00 |
| Foam Cell - Comfort | | | 24650FEC | 2 | \$232.00 |
| Foam Cell - Performance | | | 24650FE | 2 | \$232.00 |
| Foam Cell - Professional | | | 24650FEP | 2 | \$232.00 |

LEAF SPRINGS

| | Est. Lift | Additional Load | | | |
|--------|-----------|-----------------|----------------|---|----------|
| Medium | 50mm | 0 - 300kg | TOY011B | 2 | \$392.00 |
| Heavy | 50mm | 300kg - GVM | TOY011C | 2 | \$421.00 |

U-BOLTS

| | | | | | |
|------------|--|--|---------------|---|---------|
| U-Bolt Kit | | | 437UBK | 2 | \$44.00 |
|------------|--|--|---------------|---|---------|

POLYURETHANE SPRING BUSHES

| | | | | | |
|----------|--|--|--------------|---|---------|
| Bush Kit | | | 733UK | 1 | \$74.00 |
|----------|--|--|--------------|---|---------|

GREASABLE SHACKLES AND PINS

| | | | | | |
|-------------------|--|--------------|--------------|---|---------|
| Greasable Shackle | | | 386 | 2 | \$59.00 |
| Greasable Shackle | | Extended 5mm | 386-2 | 2 | \$59.00 |
| Greasable Pin | | | 385 | 2 | \$44.00 |

HELPER SPRINGS

| | | | | | |
|--------------------------|--|--|----------------|---|----------|
| Load Plus Helper Springs | | | LP2 | 1 | \$165.00 |
| Add-A-Leaf | | | ISL6010 | 1 | \$175.00 |

SUSPENSION KIT - Specify Front Leaf Springs When Ordering

| | | | | | |
|--------------------|--|--|-------------------|--|-----------|
| Medium - Nitro Gas | | | TOY010BKG2 | | \$2172.00 |
| Medium - Foam Cell | | | TOY010BKF2 | | \$2461.00 |
| Heavy - Nitro Gas | | | TOY010CKG2 | | \$2231.00 |
| Heavy - Foam Cell | | | TOY010CKF2 | | \$2520.00 |

SUSPENSION KIT CONTENTS

| | |
|-----------------|----------------------------|
| Shock Absorbers | U-Bolts |
| Leaf Springs | Polyurethane Spring Bushes |

Toyota Hilux

Solid Front Axle
1979 to 10/1983



Product Description

Part No.

Qty
Req

Retail
ea Inc GST

Please check vehicle date range (if shown) next to product description prior to ordering

SUSPENSION TO SUIT TOYOTA HILUX - 1979-10/1983

FRONT SUSPENSION

SHOCK ABSORBER

| | | | | | |
|-------------------------|--|--|-----------------|---|----------|
| Nitro Gas - Comfort | | | 12639GRC | 2 | \$160.00 |
| Nitro Gas - Performance | | | 12639GR | 2 | \$160.00 |
| Foam Cell - Performance | | | 24639FE | 2 | \$232.00 |

LEAF SPRINGS

| | Est. Lift | Additional Load | | | |
|--------------------------------|-----------|-----------------|-------------------|---|----------|
| Medium - Drivers Side (Petrol) | 50mm | 0 - 50kg | TOY010BD/S | 1 | \$218.00 |
| Medium - Near Side (Petrol) | 50mm | 0 - 50kg | TOY010BN/S | 1 | \$218.00 |
| Heavy - Drivers Side (Diesel) | 50mm | 0 - 100kg | TOY010CD/S | 1 | \$218.00 |
| Heavy - Near Side (Diesel) | 50mm | 0 - 100kg | TOY010CN/S | 1 | \$218.00 |

• Check clearance to drag link / u-bolt, ADL106 may be required

STEERING DAMPER

| | | | | | |
|-----------|--|--|-------------|---|----------|
| Foam Cell | | | 3521 | 1 | \$175.00 |
|-----------|--|--|-------------|---|----------|

U-BOLTS

| | | | | | |
|-------------------------|--|--|---------------|---|---------|
| Drivers Side U-Bolt Kit | | | 678UBK | 1 | \$44.00 |
| Near Side U-Bolt Kit | | | 437UBK | 1 | \$44.00 |

POLYURETHANE SPRING BUSHES

| | | | | | |
|----------|--|--|--------------|---|---------|
| Bush Kit | | | 732UK | 1 | \$74.00 |
|----------|--|--|--------------|---|---------|

STEERING ARMS

| | | | | | |
|----------------|--|--|---------------|---|----------|
| Drop Drag Link | | | ADL106 | 1 | \$291.00 |
|----------------|--|--|---------------|---|----------|

GREASABLE SHACKLES AND PINS

| | | | | | |
|-------------------|--|--|------------|---|---------|
| Greasable Shackle | | | 384 | 2 | \$74.00 |
| Greasable Pin | | | 385 | 2 | \$44.00 |

REAR SUSPENSION

SHOCK ABSORBER

| | | | | | |
|--------------------------|--|--|-----------------|---|----------|
| Nitro Gas - Comfort | | | 12636GRC | 2 | \$160.00 |
| Nitro Gas - Performance | | | 12636GR | 2 | \$160.00 |
| Nitro Gas - Professional | | | 12636GRP | 2 | \$160.00 |
| Foam Cell - Comfort | | | 24636FEC | 2 | \$232.00 |
| Foam Cell - Performance | | | 24636FE | 2 | \$232.00 |
| Foam Cell - Professional | | | 24636FEP | 2 | \$232.00 |

LEAF SPRINGS

| | Est. Lift | Additional Load | | | |
|--------|-----------|-----------------|----------------|---|----------|
| Medium | 50mm | 0 - 300kg | TOY011B | 2 | \$392.00 |
| Heavy | 50mm | 300kg - GVM | TOY011C | 2 | \$421.00 |

U-BOLTS

| | | | | | |
|------------|--|--|---------------|---|---------|
| U-Bolt Kit | | | 437UBK | 2 | \$44.00 |
|------------|--|--|---------------|---|---------|

POLYURETHANE SPRING BUSHES

| | | | | | |
|----------|--|--|--------------|---|---------|
| Bush Kit | | | 733UK | 1 | \$74.00 |
|----------|--|--|--------------|---|---------|

GREASABLE SHACKLES AND PINS

| | | | | | |
|-------------------|--|--------------|--------------|---|---------|
| Greasable Shackle | | | 386 | 2 | \$59.00 |
| Greasable Shackle | | Extended 5mm | 386-2 | 2 | \$59.00 |
| Greasable Pin | | | 385 | 2 | \$44.00 |

HELPER SPRINGS

| | | | | | |
|--------------------------|--|--|----------------|---|----------|
| Load Plus Helper Springs | | | LP2 | 1 | \$165.00 |
| Add-A-Leaf | | | ISL6010 | 1 | \$175.00 |

SUSPENSION KIT - Specify Front Leaf Springs When Ordering

| | | | |
|--------------------|--|-------------------|-----------|
| Medium - Nitro Gas | | TOY010BKG1 | \$2172.00 |
| Medium - Foam Cell | | TOY010BKF1 | \$2461.00 |
| Heavy - Nitro Gas | | TOY010CKG1 | \$2231.00 |
| Heavy - Foam Cell | | TOY010CKF1 | \$2520.00 |

SUSPENSION KIT CONTENTS

| | |
|-----------------|----------------------------|
| Shock Absorbers | U-Bolts |
| Leaf Springs | Polyurethane Spring Bushes |



Kluger / Highlander
2020+

SUSPENSION TO SUIT

Toyota Kluger

Product Description

Part No.

Qty
Req

Retail
ea Inc GST

Please check vehicle date range (if shown) next to product description prior to ordering

SUSPENSION TO SUIT TOYOTA KLUGER / HIGHLANDER - 2020+

REAR SUSPENSION

COIL SPRINGS

Heavy

Est. Lift

40mm

Additional Load

200kg

TOY076C

1

\$262.00

Toyota Landcruiser

300 Series
2022+



Product Description

DATE AVAILABLE

Part No.

Qty
Req

Retail
ea Inc GST

Please check vehicle date range (if shown) next to product description prior to ordering

ACCESSORIES TO SUIT TOYOTA LANDCRUISER 300 SERIES - 2022+

STEEL WINCH BULL BARS

| | | | | |
|--|--|------------------|--|-----------|
| Premium - 60.3mm Tube | | BBP090 | | \$2770.00 |
| Raid Full Length Steel Tubular Bumper | | BBR090 | | \$2658.00 |
| Raid Full Length Steel Tubular Bumper - Pre-Primed for Colour Coding | | BBR090P | | \$2658.00 |
| Camera Extension Cable - Suits BBR090* and BBP090* | | IBBCLE090 | | \$437.00 |
| Parking Sensor (4) Extension Harness - Suits BBR090 and BBP090 | | IBBPSL090 | | \$68.00 |
| Bull Bar Multi-Function Harness - For Blinker/Parker/DRL only | | IBBPL090 | | \$183.00 |

**Required if vehicle is fitted with front camera*

• Winch with Steel Cable and Roller Fairlead is not suitable when front camera is used - Use Winch with Synthetic Rope and Alloy Hawse only

LIGHTING OPTIONS - TO SUIT RAID BULL BARS

| | | | | |
|--|--|-------------------|---|----------|
| 120W Bright Sabre Single Row Lightbar 812mm (32") Straight | | ILBSR002BW | 1 | \$261.00 |
| 40W Bright Cube Spot Beam LED Cube Light - 81 x 75mm (Each) - Clear | | ILED80B | 2 | \$83.00 |
| 40W Bright Cube Spot Beam LED Cube Light - 81 x 75mm (Each) - Amber | | ILED80BA | 2 | \$83.00 |
| 40W Bright Cube Flood Beam LED Cube Light - 81 x 75mm (Each) - Clear | | ILED80BF | 2 | \$83.00 |
| 40W Bright Cube Flood Beam LED Cube Light - 81 x 75mm (Each) - Amber | | ILED80BFA | 2 | \$83.00 |

STEEL SIDE STEPS

| | | | | |
|--|----------------|----------------|--|-----------|
| Premium Side Steps - 60.3mm Tube | Q1 2023 | SSP090 | | \$1103.00 |
| Premium Side Steps and Rails - 60.3mm Tube | Q1 2023 | SSRP090 | | \$1334.00 |

RECOVERY POINTS - IRONMAN 4X4 BULL BAR ONLY

| | | | | |
|--|----------------|---------------|--|----------|
| Recovery Points - 5000kg Rating (Pair) | Q4 2022 | IRP090 | | \$340.00 |
|--|----------------|---------------|--|----------|

SNORKEL

| | | | | |
|------------------------|----------------|--------------------|--|----------|
| Landcruiser 300 Series | Q4 2022 | ISNORKEL090 | | \$437.00 |
|------------------------|----------------|--------------------|--|----------|

PREMIUM UNDERBODY PROTECTION

| | | | | |
|-----------------------------|----------------|---------------|--|----------|
| Engine Bay and Transmission | Q1 2023 | UBP090 | | \$782.00 |
|-----------------------------|----------------|---------------|--|----------|

ATLAS ROOF RACK KITS

| | | | | |
|---|--|------------------|--|-----------|
| Platform A with Blade Fit Kit - 1530mm Length | | IFR090PAK | | \$1608.00 |
| Platform E with Blade Fit Kit - 2130mm Length | | IFR090PEK | | \$2038.00 |

• See Page 36 and 37 for more Atlas rack and crossbar options.

BREATHER KIT

| | | | | |
|---|--|-----------------|--|----------|
| Universal Twin Manifold Filtered Breather Kit | | IDIFFBRE | | \$115.00 |
|---|--|-----------------|--|----------|



300 Series
2022+

Toyota Landcruiser

| Product Description | DATE AVAILABLE | Part No. | Qty Req | Retail ea Inc GST |
|---------------------|----------------|----------|------------|----------------------|
|---------------------|----------------|----------|------------|----------------------|

Please check vehicle date range (if shown) next to product description prior to ordering

SUSPENSION TO SUIT TOYOTA LANDCRUISER 300 SERIES - 2022+

FRONT SUSPENSION

SHOCK ABSORBER

| | | | | | |
|-----------------------------------|--|--|----------------|---|----------|
| Foam Cell Strut - Performance* | | | 24883FE | 2 | \$291.00 |
| Foam Cell Pro Strut - Performance | | | 45883FE | 2 | \$406.00 |

COIL SPRINGS

| | Est. Lift | Additional Load | | | |
|--------|-----------|-----------------|----------------|---|----------|
| Light | 25mm | 0 - 50kg | TOY083A | 1 | \$262.00 |
| Medium | 50mm | 0 - 50kg | TOY083B | 1 | \$262.00 |
| Heavy | 50mm | 50 - 110kg | TOY083C | 1 | \$262.00 |

STRUT MOUNTS

| | | | | | |
|-----------------|--|--|----------------|---|---------|
| Steel Strut Top | | | ISST090 | 2 | \$88.00 |
|-----------------|--|--|----------------|---|---------|

TRIM PACKERS

| | | | | | |
|------------------------|--|-----------|-----------------|---|---------|
| 5mm Strut Trim Packer | | Foam Cell | HILFR05F | 2 | \$30.00 |
| 10mm Strut Trim Packer | | Foam Cell | HILFR10F | 2 | \$30.00 |
| 15mm Strut Trim Packer | | Foam Cell | HILFR15F | 2 | \$30.00 |

• Only compatible with Ironman 4x4 Struts (except Pro), lift height subject to 2:1 motion ratio. Unnecessary fitment may lift vehicle too high

CONTROL ARMS

| | | | | | |
|------------------------------|--|--|-----------------|---|----------|
| Pro-Forge Upper Control Arms | | | UCA090FA | 1 | \$882.00 |
|------------------------------|--|--|-----------------|---|----------|

REAR SUSPENSION

SHOCK ABSORBER

| | | | | | |
|------------------------------|--|--|-----------------|---|----------|
| Foam Cell - Performance | | | 24884FE | 2 | \$232.00 |
| Foam Cell Pro - Performance | | | 45884FE | 2 | \$319.00 |
| Foam Cell Pro - Professional | | | 45884FEP | 2 | \$319.00 |

COIL SPRINGS

| | Est. Lift | Additional Load | | | | |
|---------------------------|----------------|-----------------|-------------|-----------------|---|----------|
| Light | Q4 2022 | 25mm | 0 - 200kg | TOY084A | 1 | \$276.00 |
| Medium | | 50mm | 0 - 200kg | TOY084B | 1 | \$276.00 |
| Medium (with Accessories) | Q1 2023 | 50mm | 200 - 400kg | TOY084B1 | 1 | \$276.00 |
| Heavy | | 50mm | 400 - 800kg | TOY084C | 1 | \$305.00 |
| Extra Heavy | | 50mm | 800kg+ | TOY084D | 1 | \$455.00 |

PANHARD ROD

| | | | | | |
|------------------------|--|--|-------------------|---|----------|
| Adjustable Panhard Rod | | | PANHARD016 | 1 | \$334.00 |
|------------------------|--|--|-------------------|---|----------|

ADJUSTABLE TRAILING ARM

| | | | | | |
|--------------------|--|--|---------------|---|----------|
| Lower Trailing Arm | | | LTA003 | 2 | \$276.00 |
|--------------------|--|--|---------------|---|----------|

SUSPENSION KIT - Specify Front Coil Springs When Ordering

| | | | | | |
|------------------------|--|--|------------------|--|-----------|
| Medium - Foam Cell | | | TOY083BKF | | \$1578.00 |
| Medium - Foam Cell Pro | | | TOY083BKP | | \$1984.00 |
| Heavy - Foam Cell | | | TOY083CKF | | \$1593.00 |
| Heavy - Foam Cell Pro | | | TOY083CKP | | \$1999.00 |

SUSPENSION KIT CONTENTS

| | | |
|-----------------|-----------------------|--------------|
| Shock Absorbers | Strut Shock Absorbers | Coil Springs |
|-----------------|-----------------------|--------------|

Toyota Landcruiser

200 Series (Facelift Mk II)
11/2015+



| Product Description | DATE AVAILABLE | Part No. | Qty Req | Retail ea Inc GST |
|---------------------|----------------|----------|---------|-------------------|
|---------------------|----------------|----------|---------|-------------------|

Please check vehicle date range (if shown) next to product description prior to ordering

ACCESSORIES TO SUIT TOYOTA LANDCRUISER 200 SERIES - 11/2015+

| | | | | |
|---|--|------------------|--|-----------|
| STEEL WINCH BULL BARS | | | | |
| Premium - 60.3mm Tube | | BBP056-VX | | \$2523.00 |
| Polished Alloy | | BBA056-VX | | \$2972.00 |
| Proguard No Loop | | BBT056VX-NL | | \$1973.00 |
| Proguard Single Loop Kit | | BB056-SL | | \$352.00 |
| Proguard Triple Loop Kit | | BB056-TL | | \$423.00 |
| Driving Light / Lightbar Patch Loom | | IPL056 | | \$33.00 |
| • Winch with Steel Cable and Roller Fairlead is not suitable when front camera is used - Use Winch with Synthetic Rope and Alloy Hawse only | | | | |
| STEEL SIDE STEPS AND RAILS | | | | |
| Premium Side Steps - 60.3mm Tube (Suit non KDSS model) | | SSP056 | | \$1103.00 |
| Premium Side Rails - 60.3mm Tube (Suit non KDSS model) | | SSP056 RAIL | | \$402.00 |
| Premium Side Steps and Rails - 60.3mm Tube (Suit non KDSS model) | | SSRP056 | | \$1334.00 |
| RECOVERY POINTS - IRONMAN 4X4 BULL BAR ONLY | | | | |
| Recovery Points - 5000kg Rating (Pair) (Suit KDSS and non KDSS model) | | IRP056 | | \$238.00 |
| SNORKEL | | | | |
| Landcruiser 200 Series | | ISNORKEL056 | | \$437.00 |
| LOCKSAFE DRAWER SYSTEMS | | | | |
| Twin Drawers - 1000mm | | ITD1000 | | \$1355.00 |
| Single Drawer - 1000mm | | ISD1000 | | \$820.00 |
| Wing Kit - 1000mm (May impede access to rear 240V outlet) | | ITDW020 | | \$283.00 |
| BATTERY TRAY | | | | |
| Suits 12" Battery | | IBTRAY056 | | \$156.00 |
| ATLAS ROOF RACK KITS | | | | |
| Platform A with Blade Fit Kit - 1530mm Length | | IFR056PAK | | \$1608.00 |
| Platform E with Blade Fit Kit - 2130mm Length | | IFR056PEK | | \$2005.00 |
| Crossbar (x 3) and Fit Kit - 1375mm Width | | IFR056C3K | | \$710.00 |
| • See Page 36 and 37 for more Atlas rack and crossbar options. | | | | |
| STEEL ROOF RACKS | | | | |
| Cage Style - 1.8m x 1.25m | | IRRCAGE18 | | \$852.00 |
| Rooftop Tent Compatible - 1.8m x 1.25m | | IRRTENT18 | | \$812.00 |
| Trade Style - 1.8m x 1.25m (Open end) | | IRRTRADE18 | | \$812.00 |
| ALLOY ROOF RACKS | | | | |
| Cage Style - 1.8m x 1.25m | | IRRCAGE18-ALLOY | | \$1201.00 |
| Trade Style - 1.8m x 1.25m (Open end) | | IRRTRADE18-ALLOY | | \$1183.00 |
| Flat Rack - 1.8m x 1.25m | | IRRTFLAT18-ALLOY | | \$1167.00 |
| STEEL AND ALLOY ROOF RACK - MOUNT KITS | | | | |
| Landcruiser 200 Mount Feet - 200mm (8 Feet) | | IRRFEETLC200 | | \$207.00 |
| PREMIUM UNDERBODY PROTECTION | | | | |
| Engine and Radiator | | UBP056 | | \$782.00 |
| SEAT COVER | | | | |
| Canvas Comfort - Front (Without Headrest Monitors) | | ICSC043F | | \$420.00 |
| Canvas Comfort - Rear | | ICSC043R | | \$420.00 |
| BREATHER KIT | | | | |
| Universal Twin Manifold Filtered Breather Kit | | IDIFFBRE | | \$115.00 |



200 Series (Facelift Mk II)
11/2015+

Toyota Landcruiser

Product Description

Part No.

**Qty
Req**

**Retail
ea Inc GST**

Please check vehicle date range (if shown) next to product description prior to ordering

SUSPENSION TO SUIT TOYOTA LANDCRUISER 200 SERIES - 11/2015+

FRONT SUSPENSION

SHOCK ABSORBER

| | | | | | |
|-----------------------------------|--|--|----------------|---|----------|
| Nitro Gas Strut - Performance | | | 12720GR | 2 | \$262.00 |
| Foam Cell Strut - Performance | | | 24720FE | 2 | \$291.00 |
| Foam Cell Pro Strut - Performance | | | 45720FE | 2 | \$406.00 |

COIL SPRINGS

| | Est. Lift | Additional Load | | | |
|----------|-----------|-----------------|----------------|---|----------|
| Standard | 0mm | 0-50kg | TOY063S | 1 | \$262.00 |
| Light | 25mm | 0 - 50kg | TOY063A | 1 | \$262.00 |
| Medium | 50mm | 0 - 50kg | TOY063B | 1 | \$262.00 |
| Heavy | 50mm | 50 - 110kg | TOY063C | 1 | \$262.00 |

STRUT MOUNTS

| | | | | | |
|-----------------|--|--|----------------|---|---------|
| Steel Strut Top | | | ISST004 | 2 | \$88.00 |
|-----------------|--|--|----------------|---|---------|

TRIM PACKERS

| | | | | |
|------------------------|-----------------------|-------------------------|---|---------|
| 5mm Strut Trim Packer | Nitro Gas / Foam Cell | HILFR05/HILFR05F | 2 | \$30.00 |
| 10mm Strut Trim Packer | Nitro Gas / Foam Cell | HILFR10/HILFR10F | 2 | \$30.00 |
| 15mm Strut Trim Packer | Nitro Gas / Foam Cell | HILFR15/HILFR15F | 2 | \$30.00 |

• Only compatible with Ironman 4x4 Struts (except Pro), lift height subject to 2:1 motion ratio. Unnecessary fitment may lift vehicle too high

SWAY BAR

| | | | | |
|---------------|----------------------|----------------|---|----------|
| 38mm Sway Bar | Non KDSS Models Only | ISB200F | 1 | \$609.00 |
|---------------|----------------------|----------------|---|----------|

CONTROL ARMS

| | | | | |
|------------------------------|--|-----------------|---|----------|
| Pro-Forge Upper Control Arms | | UCA056FA | 1 | \$882.00 |
|------------------------------|--|-----------------|---|----------|

REAR SUSPENSION

SHOCK ABSORBER

| | | | | | |
|------------------------------|--|--|-----------------|---|----------|
| Nitro Gas - Performance | | | 12796GR | 2 | \$160.00 |
| Foam Cell - Performance | | | 24796FE | 2 | \$232.00 |
| Foam Cell Pro - Performance | | | 45796FE | 2 | \$319.00 |
| Foam Cell Pro - Professional | | | 45796FEP | 2 | \$319.00 |

COIL SPRINGS

| | Est. Lift | Additional Load | | | |
|---------------------------|-----------|-----------------|-----------------|---|----------|
| Standard | 0mm | 0 - 200kg | TOY064S | 1 | \$276.00 |
| Light | 25mm | 0 - 200kg | TOY064A | 1 | \$276.00 |
| Medium | 50mm | 0 - 300kg | TOY064B | 1 | \$276.00 |
| Medium - with Accessories | 50mm | 100 - 400kg | TOY064EA | 1 | \$276.00 |
| Heavy | 50mm | 400 - 800kg | TOY064C | 1 | \$291.00 |
| Extra Heavy | 50mm | 800kg+ | TOY064D | 1 | \$435.00 |

PANHARD ROD

| | | | | | |
|------------------------|--|--|-------------------|---|----------|
| Adjustable Panhard Rod | | | PANHARD016 | 1 | \$334.00 |
|------------------------|--|--|-------------------|---|----------|

ADJUSTABLE TRAILING ARM

| | | | | | |
|--------------------|--|--|---------------|---|----------|
| Upper Trailing Arm | | | UTA200 | 2 | \$218.00 |
| Lower Trailing Arm | | | LTA200 | 2 | \$276.00 |

SWAY BAR

| | | | | |
|---------------|----------------------|----------------|---|----------|
| 33mm Sway Bar | Non KDSS Models Only | ISB200R | 1 | \$609.00 |
|---------------|----------------------|----------------|---|----------|

SUSPENSION KIT - Specify Front Coil Springs When Ordering

| | | |
|------------------------|------------------|-----------|
| Light - Nitro Gas | TOY063AKG | \$1376.00 |
| Light - Foam Cell | TOY063AKF | \$1578.00 |
| Light - Foam Cell Pro | TOY063AKP | \$1984.00 |
| Medium - Nitro Gas | TOY063BKG | \$1376.00 |
| Medium - Foam Cell | TOY063BKF | \$1578.00 |
| Medium - Foam Cell Pro | TOY063BKP | \$1984.00 |
| Heavy - Nitro Gas | TOY063CKG | \$1390.00 |
| Heavy - Foam Cell | TOY063CKF | \$1593.00 |
| Heavy - Foam Cell Pro | TOY063CKP | \$1999.00 |

• All kits compatible with KDSS, refer KDSS instructions available at www.ironman4x4.com

SUSPENSION KIT CONTENTS

Shock Absorbers Strut Shock Absorbers Coil Springs



OPTIONS AVAILABLE FOR THIS VEHICLE - SEE PAGE 387



Toyota Landcruiser

200 Series
11/2007 to 1/2012
(Facelift) 2/2012 to 10/2015

Product Description

Part No.

Qty
ReqRetail
ea Inc GST

Please check vehicle date range (if shown) next to product description prior to ordering

ACCESSORIES TO SUIT TOYOTA LANDCRUISER 200 SERIES - 11/2007-10/2015

STEEL WINCH BULL BARS

| | | |
|---|--------|-----------|
| Premium - 60.3mm Tube - (11/2007 to 1/2012) | BBP025 | \$2478.00 |
| Premium - 60.3mm Tube - (2/2012 to 9/2015) | BBP043 | \$2478.00 |

RECOVERY POINTS - IRONMAN 4X4 BULL BAR ONLY

| | | |
|---|--------|----------|
| Recovery Points - 5000kg Rating (Pair) - KDSS and non KDSS models | IRP056 | \$238.00 |
|---|--------|----------|

LOCKSAFE DRAWER SYSTEMS

| | | |
|---|---------|-----------|
| Twin Drawers - 1000mm | ITD1000 | \$1355.00 |
| Single Drawer - 1000mm | ISD1000 | \$820.00 |
| Wing Kit - 1000mm (May impede access to rear 240V outlet) | ITDW020 | \$283.00 |

SNORKEL

| | | |
|------------------------|-------------|----------|
| Landcruiser 200 Series | ISNORKELO10 | \$437.00 |
|------------------------|-------------|----------|

ATLAS ROOF RACK KITS

| | | |
|---|-----------|-----------|
| Platform A with Blade Fit Kit - 1530mm Length | IFR056PAK | \$1608.00 |
| Platform E with Blade Fit Kit - 2130mm Length | IFR056PEK | \$2005.00 |
| Crossbar (x 3) and Fit Kit - 1375mm Width | IFR056C3K | \$710.00 |

• See Page 36 and 37 for more Atlas rack and crossbar options.

STEEL ROOF RACKS

| | | |
|--|------------|----------|
| Cage Style - 1.8m x 1.25m | IRRCAGE18 | \$852.00 |
| Cage Style - 2.2m x 1.25m | IRRCAGE22 | \$885.00 |
| Rooftop Tent Compatible - 1.8m x 1.25m | IRRTENT18 | \$812.00 |
| Rooftop Tent Compatible - 2.2m x 1.25m | IRRTENT22 | \$852.00 |
| Trade Style - 1.8m x 1.25m (Open end) | IRRTRADE18 | \$812.00 |
| Trade Style - 2.2m x 1.25m (Open end) | IRRTRADE22 | \$846.00 |

ALLOY ROOF RACKS

| | | |
|---------------------------------------|------------------|-----------|
| Cage Style - 1.8m x 1.25m | IRRCAGE18-ALLOY | \$1201.00 |
| Cage Style - 2.2m x 1.25m | IRRCAGE22-ALLOY | \$1267.00 |
| Trade Style - 1.8m x 1.25m (Open end) | IRRTRADE18-ALLOY | \$1183.00 |
| Trade Style - 2.2m x 1.25m (Open end) | IRRTRADE22-ALLOY | \$1235.00 |
| Flat Rack - 1.8m x 1.25m | IRRTFLAT18-ALLOY | \$1167.00 |

ROOF RACK - MOUNTING KITS

| | | |
|---|-------------|----------|
| Landcruiser 200 Mount Feet - 200mm (8 Feet) | IRRFETLC200 | \$207.00 |
|---|-------------|----------|

PREMIUM UNDERBODY PROTECTION

| | | |
|---------------------|--------|----------|
| Engine and Radiator | UBP056 | \$782.00 |
|---------------------|--------|----------|

UNDERBODY PROTECTION

| | | |
|--|---------|----------|
| Engine Bay and Transmission - <i>While Stocks Last</i> | IUP004K | \$636.00 |
| Fuel Tank - <i>While Stocks Last</i> | IUP004F | \$307.00 |

• Fuel tank protection plates are not compatible with long range fuel tanks.

SEAT COVER

| | | |
|------------------------|----------|----------|
| Canvas Comfort - Front | ICSC043F | \$420.00 |
| Canvas Comfort - Rear | ICSC043R | \$420.00 |

BREATHER KIT

| | | |
|---|----------|----------|
| Universal Twin Manifold Filtered Breather Kit | IDIFFBRE | \$115.00 |
|---|----------|----------|



200 Series
11/2007 to 10/2015

Toyota Landcruiser

Product Description

Part No.

Qty Req

Retail ea Inc GST

Please check vehicle date range (if shown) next to product description prior to ordering

SUSPENSION TO SUIT TOYOTA LANDCRUISER 200 SERIES - 11/2007-10/2015

FRONT SUSPENSION

SHOCK ABSORBER

| | | | | | |
|-----------------------------------|--|--|----------------|---|----------|
| Nitro Gas Strut - Performance | | | 12720GR | 2 | \$262.00 |
| Foam Cell Strut - Performance | | | 24720FE | 2 | \$291.00 |
| Foam Cell Pro Strut - Performance | | | 45720FE | 2 | \$406.00 |

COIL SPRINGS

| | Est. Lift | Additional Load | | | |
|----------|-----------|-----------------|----------------|---|----------|
| Standard | 0mm | 0-50kg | TOY063S | 1 | \$262.00 |
| Light | 25mm | 0 - 50kg | TOY063A | 1 | \$262.00 |
| Medium | 50mm | 0 - 50kg | TOY063B | 1 | \$262.00 |
| Heavy | 50mm | 50 - 110kg | TOY063C | 1 | \$262.00 |

STRUT MOUNTS

| | | | | | |
|-----------------|--|--|----------------|---|---------|
| Steel Strut Top | | | ISST004 | 2 | \$88.00 |
|-----------------|--|--|----------------|---|---------|

TRIM PACKERS

| | | | | |
|------------------------|-----------------------|-------------------------|---|---------|
| 5mm Strut Trim Packer | Nitro Gas / Foam Cell | HILFR05/HILFR05F | 2 | \$30.00 |
| 10mm Strut Trim Packer | Nitro Gas / Foam Cell | HILFR10/HILFR10F | 2 | \$30.00 |
| 15mm Strut Trim Packer | Nitro Gas / Foam Cell | HILFR15/HILFR15F | 2 | \$30.00 |

• ONLY Compatible with Ironman 4x4 Struts (except Pro), lift height subject to 2:1 motion ratio. Unnecessary fitment may lift vehicle too high

SWAY BAR

| | | | | |
|---------------|----------------------|----------------|---|----------|
| 38mm Sway Bar | Non KDSS Models Only | ISB200F | 1 | \$609.00 |
|---------------|----------------------|----------------|---|----------|

CONTROL ARMS

| | | | | |
|------------------------------|--|-----------------|---|----------|
| Pro-Forge Upper Control Arms | | UCA056FA | 1 | \$882.00 |
|------------------------------|--|-----------------|---|----------|

REAR SUSPENSION

SHOCK ABSORBER

| | | | | | |
|------------------------------|--|--|-----------------|---|----------|
| Nitro Gas - Performance | | | 12796GR | 2 | \$160.00 |
| Foam Cell - Performance | | | 24796FE | 2 | \$232.00 |
| Foam Cell Pro - Performance | | | 45796FE | 2 | \$319.00 |
| Foam Cell Pro - Professional | | | 45796FEP | 2 | \$319.00 |

COIL SPRINGS

| | Est. Lift | Additional Load | | | |
|---------------------------|-----------|-----------------|-----------------|---|----------|
| Standard | 0mm | 0 - 200kg | TOY064S | 1 | \$276.00 |
| Light | 25mm | 0 - 200kg | TOY064A | 1 | \$276.00 |
| Medium | 50mm | 0 - 300kg | TOY064B | 1 | \$276.00 |
| Medium - with Accessories | 50mm | 100 - 400kg | TOY064EA | 1 | \$276.00 |
| Heavy | 50mm | 400kg - GVM | TOY064C | 1 | \$291.00 |
| Extra Heavy | 50mm | 800kg+ | TOY064D | 1 | \$435.00 |

PANHARD ROD

| | | | | | |
|------------------------|--|--|-------------------|---|----------|
| Adjustable Panhard Rod | | | PANHARD016 | 1 | \$334.00 |
|------------------------|--|--|-------------------|---|----------|

ADJUSTABLE TRAILING ARM

| | | | | | |
|--------------------|--|--|---------------|---|----------|
| Upper Trailing Arm | | | UTA200 | 2 | \$218.00 |
| Lower Trailing Arm | | | LTA200 | 2 | \$276.00 |

SWAY BAR

| | | | | |
|---------------|----------------------|----------------|---|----------|
| 33mm Sway Bar | Non KDSS Models Only | ISB200R | 1 | \$609.00 |
|---------------|----------------------|----------------|---|----------|

SUSPENSION KIT - Specify Front Coil Springs When Ordering

| | | |
|------------------------|------------------|-----------|
| Light - Nitro Gas | TOY063AKG | \$1376.00 |
| Light - Foam Cell | TOY063AKF | \$1578.00 |
| Light - Foam Cell Pro | TOY063AKP | \$1984.00 |
| Medium - Nitro Gas | TOY063BKG | \$1376.00 |
| Medium - Foam Cell | TOY063BKF | \$1578.00 |
| Medium - Foam Cell Pro | TOY063BKP | \$1984.00 |
| Heavy - Nitro Gas | TOY063CKG | \$1390.00 |
| Heavy - Foam Cell | TOY063CKF | \$1593.00 |
| Heavy - Foam Cell Pro | TOY063CKP | \$1999.00 |

• All kits compatible with KDSS, refer KDSS instructions available at www.ironman4x4.com

SUSPENSION KIT CONTENTS

| | |
|-----------------|-----------------------|
| Shock Absorbers | Strut Shock Absorbers |
| Coil Springs | |



Toyota Landcruiser

Product Description

Part No.

Qty
Req

Retail
ea Inc GST

Please check vehicle date range (if shown) next to product description prior to ordering

ACCESSORIES TO SUIT TOYOTA LANDCRUISER 105 SERIES - 3/1990-10/2007

STEEL WINCH BULL BARS

Commercial Deluxe

BBCD005

\$2345.00

RECOVERY POINTS - IRONMAN 4X4 BULL BAR ONLY

Recovery Points - 5000kg Rating (Pair)

IRP005

\$227.00

LOCKSAFE DRAWER SYSTEMS

Twin Drawers - 1000mm

ITD1000

\$1355.00

Single Drawer - 1000mm

ISD1000

\$820.00

Wing Kit - 1000mm (GXL 1998 to 2005)

ITDW018

\$283.00

SNORKEL

Landcruiser 105 Series

ISNORKEL003

\$437.00

STEEL ROOF RACKS

Cage Style - 1.8m x 1.25m

IRRCAGE18

\$852.00

Rooftop Tent Compatible - 1.8m x 1.25m

IRRTENT18

\$812.00

Trade Style - 1.8m x 1.25m (Open end)

IRRTRADE18

\$812.00

ALLOY ROOF RACKS

Cage Style - 1.8m x 1.25m

IRRCAGE18-ALLOY

\$1201.00

Trade Style - 1.8m x 1.25m (Open end)

IRRTRADE18-ALLOY

\$1183.00

Flat Rack - 1.8m x 1.25m

IRRFLAT18-ALLOY

\$1167.00

STEEL AND ALLOY ROOF RACK - MOUNT KITS

Landcruiser 100 Mount Feet - 100mm (8 Feet)

IRRFEETLC100

\$207.00

BREATHER KIT

Universal Twin Manifold Filtered Breather Kit

IDIFFBRE

\$115.00





105 Series
1998+

Toyota Landcruiser

Product Description

Part No.

Qty
Req

Retail
ea Inc GST

Please check vehicle date range (if shown) next to product description prior to ordering

SUSPENSION TO SUIT TOYOTA LANDCRUISER 105 SERIES - 1998+

FRONT SUSPENSION

SHOCK ABSORBER

| | | | | | |
|-----------------------------|---------------|--|------------------|---|----------|
| Nitro Gas - Performance | | | 12683GR | 2 | \$160.00 |
| Foam Cell - Performance | | | 24683FE | 2 | \$232.00 |
| Foam Cell - Performance | Suits 4" Lift | | 24683LFE | 2 | \$262.00 |
| Foam Cell - Performance | Suits 6" Lift | | 24683LFE1 | 2 | \$291.00 |
| Foam Cell Pro - Performance | | | 45683FE | 2 | \$319.00 |
| Foam Cell Pro - Performance | Suits 4" Lift | | 45683LFE | 2 | \$334.00 |
| Foam Cell Pro - Performance | Suits 6" Lift | | 45683LFE1 | 2 | \$348.00 |

COIL SPRINGS

| | Est. Lift | Additional Load | | | |
|------------------|-----------|-----------------|----------------|---|----------|
| Medium | 50mm | 0 - 50kg | TOY024B | 1 | \$262.00 |
| Medium - 4" Lift | 100mm | 0 - 100kg | TOY012C | 1 | \$406.00 |
| Medium - 6" Lift | 150mm | 0 - 100kg | TOY060B | 1 | \$479.00 |
| Heavy | 50mm | 50 - 110kg | TOY024C | 1 | \$262.00 |

STEERING DAMPER

| | | | | | |
|-----------|--|--|-------------|---|----------|
| Foam Cell | | | 3524 | 1 | \$175.00 |
|-----------|--|--|-------------|---|----------|

CASTER CORRECTION

| | | | | | |
|---|--|--|------------------|---|----------|
| 2° Offset Bush Kit - Polyurethane | | | 1144SK | 1 | \$160.00 |
| Adjustable Offset STD, 2.5, 3.5° - Polyurethane | | | 1144 | 1 | \$160.00 |
| 2° Offset Bush Kit - Rubber | | | 1144RK | 1 | \$160.00 |
| 5° Offset Plate Kit | | | CPLATE001 | 1 | \$232.00 |
| 4° Drop Box | | | DBOX001 | 1 | \$406.00 |

STEERING RODS

| | | | | | |
|----------------------|------------------|--|----------------|---|----------|
| Adjustable Drag Link | Right Hand Drive | | ADL001 | 1 | \$435.00 |
| Adjustable Drag Link | Left Hand Drive | | ADL001L | 1 | \$435.00 |
| Track Rod | | | ATR001 | 1 | \$435.00 |

ADJUSTABLE PANHARD ROD

| | | | | | |
|----------------------|--|--|-------------------|---|----------|
| Right Hand Drive Rod | | | PANHARD001 | 1 | \$334.00 |
| Left Hand Drive Rod | | | PANHARD007 | 1 | \$334.00 |

SWAY BAR LINK

| | | | | | |
|------------------------|--|--|-----------------|---|---------|
| Extended Sway Bar Link | | | SBEXT001 | 2 | \$30.00 |
|------------------------|--|--|-----------------|---|---------|

COIL SPACER

| | | | | | |
|-------------------|--|--|--------------|---|---------|
| Polyurethane 20mm | | | LCF20 | 2 | \$30.00 |
| Polyurethane 30mm | | | LCF30 | 2 | \$44.00 |

EXTENDED BRAKE HOSE

| | | | | | |
|--------------------|--|--|-----------------|---|---------|
| Single Hose Models | | | BHOSE001 | 1 | \$74.00 |
| Dual Hose Models | | | BHOSE002 | 2 | \$74.00 |

REAR SUSPENSION

SHOCK ABSORBER

| | | | | | |
|-----------------------------|---------------|--|------------------|---|----------|
| Nitro Gas - Performance | | | 12682GR | 2 | \$160.00 |
| Foam Cell - Performance | | | 24682FE | 2 | \$232.00 |
| Foam Cell - Performance | Suits 4" Lift | | 24682LFE | 2 | \$262.00 |
| Foam Cell - Performance | Suits 6" Lift | | 24682LFE1 | 2 | \$291.00 |
| Foam Cell Pro - Performance | | | 45682FE | 2 | \$319.00 |
| Foam Cell Pro - Performance | Suits 4" Lift | | 45682LFE | 2 | \$334.00 |
| Foam Cell Pro - Performance | Suits 6" Lift | | 45682LFE1 | 2 | \$348.00 |

COIL SPRINGS

| | Est. Lift | Additional Load | | | |
|---------------------------|-----------|-----------------|----------------|---|----------|
| Medium | 50mm | 0 - 200kg | TOY025B | 1 | \$262.00 |
| Medium - with Accessories | 50mm | 100 - 300kg | TOY013B | 1 | \$262.00 |
| Medium - 4" Lift | 100mm | 0 - 300kg | TOY013C | 1 | \$406.00 |
| Medium - 6" Lift | 150mm | 0 - 300kg | TOY061B | 1 | \$479.00 |
| Heavy | 50mm | 200 - 400kg | TOY025C | 1 | \$276.00 |
| Heavy - 4" Lift | 100mm | 300 - 500kg | TOY013D | 1 | \$435.00 |
| Heavy - 6" Lift | 150mm | 300 - 500kg | TOY061C | 1 | \$479.00 |
| Extra Heavy | 55mm | 400 - 500kg | TOY025D | 1 | \$435.00 |

LISTING
CONTINUED
OVER THE
PAGE



Toyota Landcruiser

105 Series
1998+



Product Description

Part No.

**Qty
Req**

**Retail
ea Inc GST**

Please check vehicle date range (if shown) next to product description prior to ordering

PANHARD ROD

| | | | | | |
|------------------------|--|--|-------------------|---|----------|
| Adjustable Panhard Rod | | | PANHARD002 | 1 | \$334.00 |
|------------------------|--|--|-------------------|---|----------|

ADJUSTABLE TRAILING ARM

| | | | | | |
|--------------------|--|--|---------------|---|----------|
| Upper Trailing Arm | | | UTA001 | 2 | \$218.00 |
| Lower Trailing Arm | | | LTA001 | 2 | \$276.00 |

SWAY BAR LINK

| | | | | | |
|------------------------|-------------|--|-----------------|---|---------|
| Extended Sway Bar Link | Side mount | | SBEXT002 | 2 | \$30.00 |
| Extended Sway Bar Link | Under mount | | SBEXT005 | 2 | \$30.00 |

COIL SPACER

| | | | | | |
|-------------------|--|--|--------------|---|---------|
| Polyurethane 15mm | | | LCR15 | 2 | \$30.00 |
| Polyurethane 30mm | | | LCR30 | 2 | \$44.00 |

BRAKE HOSE

| | | | | | |
|---------------------|--|--|-----------------|---|---------|
| Extended Brake Hose | | | BHOSE002 | 1 | \$74.00 |
|---------------------|--|--|-----------------|---|---------|

BUSH KIT

| | | | | | |
|--------------------------------|-------------------------------|--|---------------|---|----------|
| Rubber Suspension Arm Bush Kit | W/ Standard Radius Arm Bushes | | 847RK | 1 | \$421.00 |
| Rubber Suspension Arm Bush Kit | W/ Offset Radius Arm Bushes | | 847CRK | 1 | \$421.00 |

SUSPENSION KIT - Specify Front Coil Springs When Ordering

| | | | | | |
|-----------------------------|--------|----------|--------------------|--|-----------|
| Medium - Nitro Gas | | | TOY024BKG | | \$1159.00 |
| Medium - Foam Cell | | | TOY024BKF | | \$1449.00 |
| Medium - Foam Cell | 4"Lift | RH Drive | TOY012CKF1 | | \$3923.00 |
| Medium - Foam Cell | 4"Lift | LH Drive | TOY012CKF1L | | \$3923.00 |
| Medium - Foam Cell | 6"Lift | RH Drive | TOY063BKF1 | | \$4185.00 |
| Medium - Foam Cell | 6"Lift | LH Drive | TOY063BKF1L | | \$4185.00 |
| Medium - Foam Cell Pro | | | TOY024BKP | | \$1796.00 |
| Medium - Foam Cell Pro | 4"Lift | RH Drive | TOY012CKP1 | | \$4213.00 |
| Medium - Foam Cell Pro | 4"Lift | LH Drive | TOY012CKP1L | | \$4213.00 |
| Medium - Foam Cell Pro | 6"Lift | RH Drive | TOY063BKP1 | | \$4416.00 |
| Medium - Foam Cell Pro | 6"Lift | LH Drive | TOY063BKP1L | | \$4416.00 |
| Heavy - Nitro Gas | | | TOY024CKG | | \$1174.00 |
| Heavy - Foam Cell | | | TOY024CKF | | \$1463.00 |
| Heavy - Foam Cell | 4"Lift | RH Drive | TOY012CKF2 | | \$3923.00 |
| Heavy - Foam Cell | 4"Lift | LH Drive | TOY012CKF2L | | \$3953.00 |
| Heavy - Foam Cell | 6"Lift | RH Drive | TOY063BKF2 | | \$4185.00 |
| Heavy - Foam Cell | 6"Lift | LH Drive | TOY063BKF2L | | \$4185.00 |
| Heavy - Foam Cell Pro | | | TOY024CKP | | \$1810.00 |
| Heavy - Foam Cell Pro | 4"Lift | RH Drive | TOY012CKP2 | | \$4213.00 |
| Heavy - Foam Cell Pro | 4"Lift | LH Drive | TOY012CKP2L | | \$4242.00 |
| Heavy - Foam Cell Pro | 6"Lift | RH Drive | TOY063BKP2 | | \$4416.00 |
| Heavy - Foam Cell Pro | 6"Lift | LH Drive | TOY063BKP2L | | \$4416.00 |
| Extra Heavy - Nitro Gas | | | TOY024DKG | | \$1333.00 |
| Extra Heavy - Foam Cell | | | TOY024DKF | | \$1622.00 |
| Extra Heavy - Foam Cell Pro | | | TOY024DKP | | \$1969.00 |

- 4" and 6" lifts may not be legal for on-road use in your area, certification may be required for on-road use
- Due to the extreme nature of 4" and 6" lifts, further modifications may be required, and will vary between vehicles, such modifications are entirely the owners responsibility
- Ironman 4x4 accept no responsibility for any damage or injury caused by use of the these products

50MM SUSPENSION KIT CONTENTS

Shock Absorbers Coil Springs

4" AND 6" SUSPENSION KIT CONTENTS

Shock Absorbers Caster Plates
Coil Springs Brake Hoses
Panhard Rods Adjustable Trailing Arms
Sway Bar Links





100 Series HDJ100, UZJ100, IFS
3/1998 to 10/2007

Toyota Landcruiser

Product Description

Part No.

Qty
Req

Retail
ea Inc GST

Please check vehicle date range (if shown) next to product description prior to ordering

ACCESSORIES TO SUIT TOYOTA LANDCRUISER 100 SERIES - 3/1998-10/2007

STEEL WINCH BULL BARS

| | | |
|-------------------|---------|-----------|
| Commercial Deluxe | BBCD006 | \$2345.00 |
|-------------------|---------|-----------|

RECOVERY POINTS - IRONMAN 4X4 BULL BAR ONLY

| | | |
|--|--------|----------|
| Recovery Points - 5000kg Rating (Pair) | IRP005 | \$227.00 |
|--|--------|----------|

LOCKSAFE DRAWER SYSTEMS

| | | |
|-----------------------|---------|-----------|
| Twin Drawers - 1000mm | ITD1000 | \$1355.00 |
|-----------------------|---------|-----------|

| | | |
|------------------------|---------|----------|
| Single Drawer - 1000mm | ISD1000 | \$820.00 |
|------------------------|---------|----------|

| | | |
|--------------------------------------|---------|----------|
| Wing Kit - 1000mm (GXL 1998 to 2005) | ITDW018 | \$283.00 |
|--------------------------------------|---------|----------|

| | | |
|---------------------------|---------|----------|
| Wing Kit - 1000mm (2005+) | ITDW019 | \$283.00 |
|---------------------------|---------|----------|

| | | |
|------------------------|---------|----------|
| Wing Kit - 1000mm (DX) | ITDW017 | \$283.00 |
|------------------------|---------|----------|

SNORKEL

| | | |
|--------------------------------|-------------|----------|
| Landcruiser 100 / Lexus LX 470 | ISNORKEL003 | \$437.00 |
|--------------------------------|-------------|----------|

STEEL ROOF RACKS

| | | |
|---------------------------|-----------|----------|
| Cage Style - 1.8m x 1.25m | IRRCAGE18 | \$852.00 |
|---------------------------|-----------|----------|

| | | |
|--|-----------|----------|
| Rooftop Tent Compatible - 1.8m x 1.25m | IRRTENT18 | \$812.00 |
|--|-----------|----------|

| | | |
|---------------------------------------|------------|----------|
| Trade Style - 1.8m x 1.25m (Open end) | IRRTRADE18 | \$812.00 |
|---------------------------------------|------------|----------|

ALLOY ROOF RACKS

| | | |
|---------------------------|-----------------|-----------|
| Cage Style - 1.8m x 1.25m | IRRCAGE18-ALLOY | \$1201.00 |
|---------------------------|-----------------|-----------|

| | | |
|---------------------------------------|------------------|-----------|
| Trade Style - 1.8m x 1.25m (Open end) | IRRTRADE18-ALLOY | \$1183.00 |
|---------------------------------------|------------------|-----------|

| | | |
|--------------------------|------------------|-----------|
| Flat Rack - 1.8m x 1.25m | IRRTFLAT18-ALLOY | \$1167.00 |
|--------------------------|------------------|-----------|

STEEL AND ALLOY ROOF RACK - MOUNT KITS

| | | |
|---|--------------|----------|
| Landcruiser 100 Mount Feet - 100mm (8 Feet) | IRRFEETLC100 | \$207.00 |
|---|--------------|----------|

BREATHER KIT

| | | |
|---|----------|----------|
| Universal Twin Manifold Filtered Breather Kit | IDIFFBRE | \$115.00 |
|---|----------|----------|



Toyota Landcruiser

100 Series, IFS
1998+



Product Description

Part No.

Qty
Req

Retail
ea Inc GST

Please check vehicle date range (if shown) next to product description prior to ordering

SUSPENSION TO SUIT TOYOTA LANDCRUISER 100 SERIES - 1998+

FRONT SUSPENSION

SHOCK ABSORBER

| | | | | | |
|-----------------------------|--|--|----------------|---|----------|
| Nitro Gas - Performance | | | 12795GR | 2 | \$160.00 |
| Foam Cell - Performance | | | 24795FE | 2 | \$232.00 |
| Foam Cell Pro - Performance | | | 45795FE | 2 | \$319.00 |

TORSION BAR

| | | | | | |
|----------------------|---------------|---------------|---------------|---|----------|
| Uprated Torsion Bars | Petrol Models | 1160mm Length | TOY050 | 1 | \$522.00 |
| Uprated Torsion Bars | Diesel Models | 1210mm Length | TOY051 | 1 | \$522.00 |

• Must Install BRACKET100

• Some Middle Eastern Petrol models use TOY051 check length before ordering

• Minimum 60mm downward suspension travel required after adjustment

DIFF DROP KIT

| | | | | | |
|---------------|--|--|---------------|---|----------|
| Diff Drop Kit | | | IDD100 | 1 | \$406.00 |
|---------------|--|--|---------------|---|----------|

CONTROL ARM

| | | | | | |
|---------------------------|--|--|-------------------|---|---------|
| Control Arm Reinforcement | | | BRACKET100 | 1 | \$44.00 |
|---------------------------|--|--|-------------------|---|---------|

REAR SUSPENSION

SHOCK ABSORBER

| | | | | | |
|------------------------------|--|--|-----------------|---|----------|
| Nitro Gas - Performance | | | 12796GR | 2 | \$160.00 |
| Foam Cell - Performance | | | 24796FE | 2 | \$232.00 |
| Foam Cell Pro - Performance | | | 45796FE | 2 | \$319.00 |
| Foam Cell Pro - Professional | | | 45796FEP | 2 | \$319.00 |

COIL SPRINGS

| | Est. Lift | Additional Load | | | |
|-------------|-----------|-----------------|----------------|---|----------|
| Medium | 25mm | 0 - 200kg | TOY013B | 1 | \$262.00 |
| Heavy | 25mm | 200 - 400kg | TOY025C | 1 | \$276.00 |
| Extra Heavy | 30mm | 400kg - GVM | TOY025D | 1 | \$435.00 |

ADJUSTABLE TRAILING ARM

| | | | | | |
|--------------------|--|--|---------------|---|----------|
| Upper Trailing Arm | | | UTA003 | 2 | \$218.00 |
| Lower Trailing Arm | | | LTA003 | 2 | \$276.00 |

SUSPENSION KIT

| | | | |
|-----------------------------|--------|------------------|-----------|
| Medium - Nitro Gas | Petrol | TOY050BKG | \$1463.00 |
| Medium - Nitro Gas | Diesel | TOY051BKG | \$1463.00 |
| Medium - Foam Cell | Petrol | TOY050BKF | \$1753.00 |
| Medium - Foam Cell | Diesel | TOY051BKF | \$1753.00 |
| Medium - Foam Cell Pro | Petrol | TOY050BKP | \$2100.00 |
| Medium - Foam Cell Pro | Diesel | TOY051BKP | \$2100.00 |
| Heavy - Nitro Gas | Petrol | TOY050CKG | \$1477.00 |
| Heavy - Nitro Gas | Diesel | TOY051CKG | \$1477.00 |
| Heavy - Foam Cell | Petrol | TOY050CKF | \$1767.00 |
| Heavy - Foam Cell | Diesel | TOY051CKF | \$1767.00 |
| Heavy - Foam Cell Pro | Petrol | TOY050CKP | \$2115.00 |
| Heavy - Foam Cell Pro | Diesel | TOY051CKP | \$2115.00 |
| Extra Heavy - Nitro Gas | Petrol | TOY050DKG | \$1637.00 |
| Extra Heavy - Nitro Gas | Diesel | TOY051DKG | \$1637.00 |
| Extra Heavy - Foam Cell | Petrol | TOY050DKF | \$1926.00 |
| Extra Heavy - Foam Cell | Diesel | TOY051DKF | \$1926.00 |
| Extra Heavy - Foam Cell Pro | Petrol | TOY050DKP | \$2273.00 |
| Extra Heavy - Foam Cell Pro | Diesel | TOY051DKP | \$2273.00 |

• Some Middle Eastern Petrol models use TOY051 check Torsion Bar length before ordering

SUSPENSION KIT CONTENTS

Shock Absorbers
Coil Springs

Torsion Bars
Control Arm Reinforcement



80 Series HZJ80, FZJ80
1990 to 1998

Toyota Landcruiser

| Product Description | Part No. | Qty Req | Retail ea Inc GST |
|---|------------------|------------|----------------------|
| ACCESSORIES TO SUIT TOYOTA LANDCRUISER 80 SERIES - 1990-1998 | | | |
| STEEL WINCH BULL BARS | | | |
| Commercial Deluxe | BBCD004 | | \$2345.00 |
| RECOVERY POINTS - IRONMAN 4X4 BULL BAR ONLY | | | |
| Recovery Points - 5000kg Rating (Pair) | IRP005 | | \$227.00 |
| LOCKSAFE DRAWER SYSTEMS | | | |
| Twin Drawers - 1000mm | ITD1000 | | \$1355.00 |
| Single Drawer - 1000mm | ISD1000 | | \$820.00 |
| Wing Kit - 1000mm (GXL) | ITDW016 | | \$283.00 |
| Wing Kit - 1000mm (DX) | ITDW015 | | \$283.00 |
| SNORKEL | | | |
| Landcruiser / Lexus LX 450 | ISNORKEL004 | | \$437.00 |
| STEEL ROOF RACKS | | | |
| Cage Style - 1.4m x 1.25m | IRRCAGE14 | | \$812.00 |
| Cage Style - 1.8m x 1.25m | IRRCAGE18 | | \$852.00 |
| Cage Style - 2.2m x 1.25m | IRRCAGE22 | | \$885.00 |
| Rooftop Tent Compatible - 1.8m x 1.25m | IRRTENT18 | | \$812.00 |
| Rooftop Tent Compatible - 2.2m x 1.25m | IRRTENT22 | | \$852.00 |
| Trade Style - 1.8m x 1.25m (Open end) | IRRTADE18 | | \$812.00 |
| Trade Style - 2.2m x 1.25m (Open end) | IRRTADE22 | | \$846.00 |
| ALLOY ROOF RACKS | | | |
| Cage Style - 1.4m x 1.25m | IRRCAGE14-ALLOY | | \$1028.00 |
| Cage Style - 1.8m x 1.25m | IRRCAGE18-ALLOY | | \$1201.00 |
| Cage Style - 2.2m x 1.25m | IRRCAGE22-ALLOY | | \$1267.00 |
| Trade Style - 1.8m x 1.25m (Open end) | IRRTADE18-ALLOY | | \$1183.00 |
| Trade Style - 2.2m x 1.25m (Open end) | IRRTADE22-ALLOY | | \$1235.00 |
| Flat Rack - 1.8m x 1.25m | IRRTFLAT18-ALLOY | | \$1167.00 |
| STEEL AND ALLOY ROOF RACK - MOUNT KITS | | | |
| Gutter Mount Feet - 125mm (8 Feet) | IRRFEET125 | | \$207.00 |
| BREATHER KIT | | | |
| Universal Twin Manifold Filtered Breather Kit | IDIFFBRE | | \$115.00 |

LISTING
CONTINUED
OVER THE
PAGE

Toyota Landcruiser

80 Series
1990+



Product Description

Part No.

Qty
Req

Retail
ea Inc GST

Please check vehicle date range (if shown) next to product description prior to ordering

SUSPENSION TO SUIT TOYOTA LANDCRUISER 80 SERIES - 1990+

FRONT SUSPENSION

SHOCK ABSORBER

| | | | | | |
|-----------------------------|--|---------------|------------------|---|----------|
| Nitro Gas - Performance | | | 12683GR | 2 | \$160.00 |
| Foam Cell - Performance | | | 24683FE | 2 | \$232.00 |
| Foam Cell - Performance | | Suits 4" Lift | 24683LFE | 2 | \$262.00 |
| Foam Cell - Performance | | Suits 6" Lift | 24683LFE1 | 2 | \$291.00 |
| Foam Cell Pro - Performance | | | 45683FE | 2 | \$319.00 |
| Foam Cell Pro - Performance | | Suits 4" Lift | 45683LFE | 2 | \$334.00 |
| Foam Cell Pro - Performance | | Suits 6" Lift | 45683LFE1 | 2 | \$348.00 |

COIL SPRINGS

| | Est. Lift | Additional Load | | | |
|------------------|-----------|-----------------|----------------|---|----------|
| Medium | 50mm | 0 - 50kg | TOY024B | 1 | \$262.00 |
| Medium - 4" Lift | 100mm | 0 - 100kg | TOY012C | 1 | \$406.00 |
| Medium - 6" Lift | 150mm | 0 - 100kg | TOY060B | 1 | \$479.00 |
| Heavy | 50mm | 50 - 110kg | TOY024C | 1 | \$262.00 |

STEERING DAMPER

| | | | | | |
|-----------|--|--|-------------|---|----------|
| Foam Cell | | | 3524 | 1 | \$175.00 |
|-----------|--|--|-------------|---|----------|

CASTER CORRECTION

| | | | | | |
|---|--|--|------------------|---|----------|
| 2° Offset Bush Kit - Polyurethane | | | 1144SK | 1 | \$160.00 |
| Adjustable Offset STD, 2.5, 3.5° - Polyurethane | | | 1144 | 1 | \$160.00 |
| 2° Offset Bush Kit - Rubber | | | 1144RK | 1 | \$160.00 |
| 5° Offset Plate Kit | | | CPLATE001 | 1 | \$232.00 |
| 4° Drop Box | | | DBOX001 | 1 | \$406.00 |

STEERING ROD

| | | | | | |
|----------------------|------------------|--|----------------|---|----------|
| Adjustable Drag Link | Right Hand Drive | | ADL001 | 1 | \$435.00 |
| Adjustable Drag Link | Left Hand Drive | | ADL001L | 1 | \$435.00 |
| Track Rod | | | ATRO01 | 1 | \$435.00 |

ADJUSTABLE PANHARD ROD

| | | | | | |
|----------------------|--|--|-------------------|---|----------|
| Right Hand Drive Rod | | | PANHARD001 | 1 | \$334.00 |
| Left Hand Drive Rod | | | PANHARD007 | 1 | \$334.00 |

SWAY BAR LINK

| | | | | | |
|------------------------|--|--|-----------------|---|---------|
| Extended Sway Bar Link | | | SBEXT001 | 2 | \$30.00 |
|------------------------|--|--|-----------------|---|---------|

COIL SPACER

| | | | | | |
|-------------------|--|--|--------------|---|---------|
| Polyurethane 20mm | | | LCF20 | 2 | \$30.00 |
| Polyurethane 30mm | | | LCF30 | 2 | \$44.00 |

EXTENDED BRAKE HOSE

| | | | | | |
|--------------------|--|--|-----------------|---|---------|
| Single Hose Models | | | BHOSE001 | 1 | \$74.00 |
| Dual Hose Models | | | BHOSE002 | 2 | \$74.00 |

REAR SUSPENSION

SHOCK ABSORBER

| | | | | | |
|-----------------------------|--|---------------|------------------|---|----------|
| Nitro Gas - Performance | | | 12682GR | 2 | \$160.00 |
| Foam Cell - Performance | | | 24682FE | 2 | \$232.00 |
| Foam Cell - Performance | | Suits 4" Lift | 24682LFE | 2 | \$262.00 |
| Foam Cell - Performance | | Suits 6" Lift | 24682LFE1 | 2 | \$291.00 |
| Foam Cell Pro - Performance | | | 45682FE | 2 | \$319.00 |
| Foam Cell Pro - Performance | | Suits 4" Lift | 45682LFE | 2 | \$334.00 |
| Foam Cell Pro - Performance | | Suits 6" Lift | 45682LFE1 | 2 | \$348.00 |

COIL SPRINGS

| | Est. Lift | Additional Load | | | |
|---------------------------|-----------|-----------------|----------------|---|----------|
| Medium | 50mm | 0 - 200kg | TOY025B | 1 | \$262.00 |
| Medium - with Accessories | 50mm | 100 - 300kg | TOY013B | 1 | \$262.00 |
| Medium - 4" Lift | 100mm | 0 - 300kg | TOY013C | 1 | \$406.00 |
| Medium - 6" Lift | 150mm | 0 - 300kg | TOY061B | 1 | \$479.00 |
| Heavy | 50mm | 200 - 400kg | TOY025C | 1 | \$276.00 |
| Heavy - 4" Lift | 100mm | 300 - 500kg | TOY013D | 1 | \$435.00 |
| Heavy - 6" Lift | 150mm | 300 - 500kg | TOY061C | 1 | \$479.00 |
| Extra Heavy | 55mm | 400 - 500kg | TOY025D | 1 | \$435.00 |

PANHARD ROD

| | | | | | |
|------------------------|--|--|-------------------|---|----------|
| Adjustable Panhard Rod | | | PANHARD002 | 1 | \$334.00 |
|------------------------|--|--|-------------------|---|----------|

ADJUSTABLE TRAILING ARM

| | | | | | |
|--------------------|--|--|---------------|---|----------|
| Upper Trailing Arm | | | UTA001 | 2 | \$218.00 |
| Lower Trailing Arm | | | LTA001 | 2 | \$276.00 |





80 Series
1990+

Toyota Landcruiser

| Product Description | | Part No. | Qty Req | Retail ea Inc GST |
|---|-------------------------------|----------|---------|-------------------|
| <i>Please check vehicle date range (if shown) next to product description prior to ordering</i> | | | | |
| SWAY BAR LINK | | | | |
| Extended Sway Bar Link | Side Mount | SBEXT002 | 2 | \$30.00 |
| Extended Sway Bar Link | Under Mount | SBEXT005 | 2 | \$30.00 |
| COIL SPACER | | | | |
| Polyurethane 15mm | | LCR15 | 2 | \$30.00 |
| Polyurethane 30mm | | LCR30 | 2 | \$44.00 |
| BUSH KIT | | | | |
| Rubber Suspension Arm Bush Kit | W/ Standard Radius Arm Bushes | 847RK | 1 | \$421.00 |
| Rubber Suspension Arm Bush Kit | W/ Offset Radius Arm Bushes | 847CRK | 1 | \$421.00 |

SUSPENSION KIT - Specify Front Coil Springs When Ordering

| | | | | |
|-----------------------------|--------|----------|-------------|-----------|
| Medium - Nitro Gas | | | TOY024BKG | \$1159.00 |
| Medium - Foam Cell | | | TOY024BKF | \$1449.00 |
| Medium - Foam Cell | 4"Lift | RH Drive | TOY012CKF1 | \$3923.00 |
| Medium - Foam Cell | 4"Lift | LH Drive | TOY012CKF1L | \$3923.00 |
| Medium - Foam Cell | 6"Lift | RH Drive | TOY063BKF1 | \$4185.00 |
| Medium - Foam Cell | 6"Lift | LH Drive | TOY063BKF1L | \$4185.00 |
| Medium - Foam Cell Pro | | | TOY024BKP | \$1796.00 |
| Medium - Foam Cell Pro | 4"Lift | RH Drive | TOY012CKP1 | \$4213.00 |
| Medium - Foam Cell Pro | 4"Lift | LH Drive | TOY012CKP1L | \$4213.00 |
| Medium - Foam Cell Pro | 6"Lift | RH Drive | TOY063BKP1 | \$4416.00 |
| Medium - Foam Cell Pro | 6"Lift | LH Drive | TOY063BKP1L | \$4416.00 |
| Heavy - Nitro Gas | | | TOY024CKG | \$1174.00 |
| Heavy - Foam Cell | | | TOY024CKF | \$1463.00 |
| Heavy - Foam Cell | 4"Lift | RH Drive | TOY012CKF2 | \$3923.00 |
| Heavy - Foam Cell | 4"Lift | LH Drive | TOY012CKF2L | \$3953.00 |
| Heavy - Foam Cell | 6"Lift | RH Drive | TOY063BKF2 | \$4185.00 |
| Heavy - Foam Cell | 6"Lift | LH Drive | TOY063BKF2L | \$4185.00 |
| Heavy - Foam Cell Pro | | | TOY024CKP | \$1810.00 |
| Heavy - Foam Cell Pro | 4"Lift | RH Drive | TOY012CKP2 | \$4213.00 |
| Heavy - Foam Cell Pro | 4"Lift | LH Drive | TOY012CKP2L | \$4242.00 |
| Heavy - Foam Cell Pro | 6"Lift | RH Drive | TOY063BKP2 | \$4416.00 |
| Heavy - Foam Cell Pro | 6"Lift | LH Drive | TOY063BKP2L | \$4416.00 |
| Extra Heavy - Nitro Gas | | | TOY024DKG | \$1333.00 |
| Extra Heavy - Foam Cell | | | TOY024DKF | \$1622.00 |
| Extra Heavy - Foam Cell Pro | | | TOY024DKP | \$1969.00 |

- 4" and 6" lifts may not be legal for on-road use in your area, certification may be required for on-road use
- Due to the extreme nature of 4" and 6" lifts, further modifications may be required, and will vary between vehicles, such modifications are entirely the owners responsibility
- Ironman 4x4 accept no responsibility for any damage or injury caused by use of these products

50MM SUSPENSION KIT CONTENTS

Shock Absorbers Coil Springs

4" AND 6" SUSPENSION KIT CONTENTS

Shock Absorbers Caster Plates
 Coil Springs Brake Hoses
 Panhard Rods Adjustable Trailing Arms
 Sway Bar Links





Toyota Landcruiser

Product Description

Part No.

Qty
ReqRetail
ea Inc GST

Please check vehicle date range (if shown) next to product description prior to ordering

ACCESSORIES TO SUIT TOYOTA LANDCRUISER 79 SERIES SINGLE CAB - 1999+

STEEL WINCH BULL BARS (NO SIDE PLATES ON BAR)

| | | |
|---|----------|-----------|
| Commercial - (9/2016+ Only) | BBC019SC | \$1648.00 |
| Commercial - (2007 to 8/2016 Only) | BBC019E | \$1648.00 |
| Commercial Deluxe - (1999 to 2007 Only) | BBCD018 | \$2345.00 |
| Premium - 60.3mm Tube - (2007 to 8/2016 Only) | BBP019E | \$2098.00 |

STEEL SIDE STEPS AND RAILS

| | | |
|--|---------------|-----------|
| Side Steps - (9/2016+ Only) | SS019SC | \$1006.00 |
| Side Steps - (2007 to 8/2016 Only) | SS016 | \$1006.00 |
| Side Rails - (9/2016+ Only) | SS019SC RAIL | \$332.00 |
| Side Steps and Rails - (9/2016+ Only) | SSR019SC | \$1207.00 |
| Side Steps and Rails - (2007 to 8/2016 Only) | SSR016 | \$1207.00 |
| Premium Side Steps - 60.3mm Tube - (9/2016+ Only) | SSP019SC | \$1103.00 |
| Premium Side Rails - 60.3mm Tube - (9/2016+ Only) | SSP019SC RAIL | \$402.00 |
| Premium Side Steps and Rails - 60.3mm Tube - (9/2016+ Only) | SSRP019SC | \$1334.00 |
| Premium Side Steps and Rails - 60.3mm Tube - (2007 to 8/2016 Only) | SSRP016 | \$1334.00 |

RECOVERY POINTS - IRONMAN 4X4 BULL BAR ONLY

| | | |
|--|----------|----------|
| Recovery Points - 5000kg Rating (Pair) - (9/2016+ Only) | IRP019SC | \$245.00 |
| Recovery Points - 5000kg Rating (Pair) - (2007 to 8/2016 Only) | IRP019 | \$245.00 |

SNORKEL

| | | |
|---|-------------|----------|
| Landcruiser 79 Series V8 - (2007+ Only) | ISNORKEL023 | \$437.00 |
| Landcruiser 4.2L 1HZ Diesel - (1999 to 2007 Only) | ISNORKEL009 | \$437.00 |

PREMIUM UNDERBODY PROTECTION

| | | |
|--|----------|----------|
| Radiator and Steering Rods - (9/2016+ Only) | UBP019SC | \$304.00 |
| Radiator and Steering Rods - (2007 to 8/2016 Only) | UBP019 | \$304.00 |

SEAT COVER

| | | |
|---|-------------|----------|
| Canvas Comfort - Front - (9/2016+ Only) | ICSC019SCF | \$420.00 |
| Canvas Comfort - Front Bucket Pair - (2007 to 8/2016 Only) | ICSC019F | \$420.00 |
| Canvas Comfort - Front Bucket and 3/4 Bench - (2007 to 8/2016 Only) | ICSC019F3/4 | \$420.00 |

BREATHER KIT

| | | |
|---|----------|----------|
| Universal Twin Manifold Filtered Breather Kit | IDIFFBRE | \$115.00 |
|---|----------|----------|



79 Series (V8 TD) Single Cab
9/2016+
2007 to 8/2016
1999 to 2007

SUSPENSION TO SUIT

Toyota Landcruiser

Product Description

Part No.

Qty
Req

Retail
ea Inc GST

Please check vehicle date range (if shown) next to product description prior to ordering

SUSPENSION TO SUIT TOYOTA LANDCRUISER 79 SERIES SINGLE CAB - 1999+

FRONT SUSPENSION

SHOCK ABSORBER

| | | | | | |
|------------------------------|--|--|-----------------|---|----------|
| Nitro Gas - Performance | | | 12091GR | 2 | \$160.00 |
| Foam Cell - Performance | | | 24091FE | 2 | \$232.00 |
| Foam Cell Pro - Performance | | | 45091FE | 2 | \$319.00 |
| Foam Cell Pro - Professional | | | 45091FEP | 2 | \$319.00 |

COIL SPRINGS

| | Est. Lift | Additional Load | | | |
|------------------|-----------|-----------------|----------------|---|----------|
| Light | 40mm | 0 - 50kg | TOY046A | 1 | \$262.00 |
| Medium | 50mm | 0 - 50kg | TOY046B | 1 | \$262.00 |
| Heavy | 50mm | 50 - 110kg | TOY046C | 1 | \$262.00 |
| Medium - 4" Lift | 100mm | 0 - 50kg | TOY079B | 1 | \$262.00 |

STEERING DAMPER

| | | | | |
|-----------|-----------|-------------|---|----------|
| Foam Cell | 1999-2006 | 3524 | 1 | \$175.00 |
| Foam Cell | 2007+ | 3525 | 1 | \$175.00 |

CASTER CORRECTION

| | | | | |
|---|--|---------------|---|----------|
| 2° Offset Bush Kit - Polyurethane | | 1144SK | 1 | \$160.00 |
| Adjustable Offset STD, 2.5, 3.5 Degree - Polyurethane | | 1144 | 1 | \$160.00 |
| 2° Offset Bush Kit - Rubber | | 1144RK | 1 | \$160.00 |

STEERING RODS

| | | | | |
|----------------------|----------------------------|---------------|---|----------|
| Adjustable Drag Link | 2007+ Wide Body Model Only | ADL070 | 1 | \$435.00 |
| Adjustable Track Rod | 2007+ Wide Body Model Only | ATR070 | 1 | \$435.00 |

PANHARD ROD

| | | | | |
|------------------------|----------------|--------------------|---|----------|
| Adjustable Panhard Rod | 2007+ RHD Only | PANHARD013 | 1 | \$334.00 |
| Adjustable Panhard Rod | 2007+ LHD Only | PANHARD013L | 1 | \$334.00 |

SWAY BAR

| | | | | |
|---------------|-----------------------|------------------|---|----------|
| 33mm Sway Bar | Narrow Body 1999-2007 | ISB789F | 1 | \$609.00 |
| 33mm Sway Bar | Petrol Engines 2007+ | ISB789FWP | 1 | \$609.00 |
| 33mm Sway Bar | Diesel Engines 2007+ | ISB789FW | 1 | \$609.00 |

SWAY BAR LINK

| | | | | |
|------------------------|--|-----------------|---|---------|
| Extended Sway Bar Link | | SBEXT001 | 2 | \$30.00 |
|------------------------|--|-----------------|---|---------|

COIL SPACER

| | | | | |
|-------------------|--|----------------|---|---------|
| Polyurethane 30mm | | LC70F30 | 2 | \$44.00 |
|-------------------|--|----------------|---|---------|

REAR SUSPENSION

SHOCK ABSORBER

| | | | | | |
|---|--|--|------------------|---|----------|
| Nitro Gas - Comfort | | | 12094GRC | 2 | \$160.00 |
| Nitro Gas - Performance | | | 12094GR | 2 | \$160.00 |
| Foam Cell - Comfort | | | 24094FEC | 2 | \$232.00 |
| Foam Cell - Performance | | | 24094FE | 2 | \$232.00 |
| Foam Cell - Professional | | | 24094FEP | 2 | \$232.00 |
| Foam Cell - Extra Long - Comfort | | | 24094LFEC | 2 | \$262.00 |
| Foam Cell - Extra Long - Performance | | | 24094LFE | 2 | \$262.00 |
| Foam Cell - Extra Long - Professional | | | 24094LFEP | 2 | \$262.00 |
| Foam Cell Pro - Comfort | | | 45094FEC | 2 | \$319.00 |
| Foam Cell Pro - Performance | | | 45094FE | 2 | \$319.00 |
| Foam Cell Pro - Professional | | | 45094FEP | 2 | \$319.00 |
| Foam Cell Pro - Extra Long - Comfort | | | 45094LFEC | 2 | \$334.00 |
| Foam Cell Pro - Extra Long - Performance | | | 45094LFE | 2 | \$334.00 |
| Foam Cell Pro - Extra Long - Professional | | | 45094LFEP | 2 | \$334.00 |

LEAF SPRINGS

| | Est. Lift | Additional Load | | | |
|-------------|-----------|-----------------|----------------|---|----------|
| Light | 50mm | 0 - 150kg | TOY047A | 2 | \$609.00 |
| Medium | 50mm | 0 - 250kg | TOY047B | 2 | \$653.00 |
| Heavy | 50mm | 250 - 400kg | TOY047C | 2 | \$682.00 |
| Extra Heavy | 50mm | 400kg - 600kg | TOY047D | 2 | \$725.00 |
| Super Heavy | 50mm | 600kg - GVM | TOY047E | 2 | \$739.00 |

LISTING
CONTINUED
OVER THE
PAGE



Toyota Landcruiser

Product Description

Part No.

**Qty
Req**

**Retail
ea Inc GST**

Please check vehicle date range (if shown) next to product description prior to ordering

U-BOLTS

| | | | | |
|-----------------------|---------------------------------|----------------|---|---------|
| U-Bolt Kit | | 416UBK | 2 | \$44.00 |
| U-Bolt Kit Extra Long | Suit TOY047D and TOY047E Spring | 416UBKL | 2 | \$44.00 |

POLYURETHANE SPRING BUSHES

| | | | | |
|----------|--|---------------|---|---------|
| Bush Kit | | 1085UK | 1 | \$88.00 |
|----------|--|---------------|---|---------|

SWAY BAR

| | | | | |
|--|------------|-----------------|---|----------|
| 30mm Sway Bar (Includes Mounting Brackets) | 2007+ Only | ISB789RW | 1 | \$609.00 |
|--|------------|-----------------|---|----------|

GREASABLE SHACKLES AND PINS

| | | | | |
|-------------------|--|-------------|---|---------|
| Greasable Shackle | | 1141 | 2 | \$74.00 |
| Greasable Pin | | 1142 | 2 | \$44.00 |

HELPER SPRINGS

| | | | | |
|--------------------------|------------------------|------------|---|----------|
| Load Plus Helper Springs | Drum Brake Models Only | LP9 | 1 | \$234.00 |
|--------------------------|------------------------|------------|---|----------|

SUSPENSION KIT - Specify Front Coil Springs When Ordering

| | | | | |
|-----------------------------|--|-------------------|--|-----------|
| Light - Nitro Gas | | TOY046AKG1 | | \$2288.00 |
| Light - Foam Cell | | TOY046AKF1 | | \$2577.00 |
| Light - Foam Cell Pro | | TOY046AKP1 | | \$2925.00 |
| Medium - Nitro Gas | | TOY046BKG1 | | \$2375.00 |
| Medium - Foam Cell | | TOY046BKF1 | | \$2664.00 |
| Medium - Foam Cell Pro | | TOY046BKP1 | | \$3012.00 |
| Heavy - Nitro Gas | | TOY046CKG1 | | \$2433.00 |
| Heavy - Foam Cell | | TOY046CKF1 | | \$2723.00 |
| Heavy - Foam Cell Pro | | TOY046CKP1 | | \$3070.00 |
| Extra Heavy - Nitro Gas | | TOY046DKG1 | | \$2520.00 |
| Extra Heavy - Foam Cell | | TOY046DKF1 | | \$2867.00 |
| Extra Heavy - Foam Cell Pro | | TOY046DKP1 | | \$3186.00 |
| Super Heavy - Foam Cell | | TOY046EKF1 | | \$2896.00 |
| Super Heavy - Foam Cell Pro | | TOY046EKP1 | | \$3215.00 |

SUSPENSION KIT CONTENTS

| | | |
|-----------------|--------------|----------------------------|
| Shock Absorbers | Leaf Springs | Polyurethane Spring Bushes |
| Coil Springs | U-Bolts | |



OPTIONS AVAILABLE FOR THIS VEHICLE 2007+ ONLY - SEE PAGE 388



79 Series Dual Cab
11/2012+

Toyota Landcruiser

Product Description

Part No.

Qty
ReqRetail
ea Inc GST

Please check vehicle date range (if shown) next to product description prior to ordering

ACCESSORIES TO SUIT TOYOTA LANDCRUISER 79 SERIES DUAL CAB - 11/2012+

STEEL WINCH BULL BARS (NO SIDE PLATES ON BAR)

| | | |
|-----------------------|---------|-----------|
| Commercial | BBC019E | \$1648.00 |
| Premium - 60.3mm Tube | BBP019E | \$2098.00 |

STEEL SIDE STEPS AND RAILS

| | | |
|---|---------|-----------|
| Side Steps | SS019 | \$1006.00 |
| Side Steps and Rails | SSR019 | \$1207.00 |
| Premium Side Steps and Rails - 60.3mm Tube* | SSRP019 | \$1334.00 |

*May require the fitment of spacers under gearbox cross-member mount

RECOVERY POINTS - IRONMAN 4X4 BULL BAR ONLY

| | | |
|--|--------|----------|
| Recovery Points - 5000kg Rating (Pair) | IRP019 | \$245.00 |
|--|--------|----------|

SNORKEL

| | | |
|--------------------------|-------------|----------|
| Landcruiser 79 Series V8 | ISNORKEL023 | \$437.00 |
|--------------------------|-------------|----------|

PREMIUM UNDERBODY PROTECTION

| | | |
|----------------------------|--------|----------|
| Radiator and Steering Rods | UBP019 | \$304.00 |
|----------------------------|--------|----------|

ATLAS DUAL CAB ROOF RACK KITS

| | | |
|---|-----------|-----------|
| Platform S with Blade Fit Kit (Dual Cab Only) - 1390mm Length | IFR019PSK | \$1253.00 |
| Crossbar (x 2) and Fit Kit - 1650mm Width | IFR019C2K | \$533.00 |

• See Page 36 and 37 for more Atlas rack and crossbar options.

STEEL ROOF RACKS

| | | |
|--|------------|----------|
| Cage Style - 1.4m x 1.25m | IRRCAGE14 | \$812.00 |
| Cage Style - 1.8m x 1.25m | IRRCAGE18 | \$852.00 |
| Rooftop Tent Compatible - 1.8m x 1.25m | IRRTENT18 | \$812.00 |
| Trade Style - 1.8m x 1.25m (Open end) | IRRTRADE18 | \$812.00 |

ALLOY ROOF RACKS

| | | |
|---------------------------------------|------------------|-----------|
| Cage Style - 1.4m x 1.25m | IRRCAGE14-ALLOY | \$1028.00 |
| Cage Style - 1.8m x 1.25m | IRRCAGE18-ALLOY | \$1201.00 |
| Trade Style - 1.4m x 1.25m (Open end) | IRROPEN14-ALLOY | \$1015.00 |
| Trade Style - 1.8m x 1.25m (Open end) | IRRTRADE18-ALLOY | \$1183.00 |
| Flat Rack - 1.8m x 1.25m | IRRTFLAT18-ALLOY | \$1167.00 |

STEEL AND ALLOY ROOF RACK - MOUNT KITS

| | | |
|------------------------------------|------------|----------|
| Gutter Mount Feet - 125mm (8 Feet) | IRRFEET125 | \$207.00 |
|------------------------------------|------------|----------|

SEAT COVER

| | | |
|---|-------------|----------|
| Canvas Comfort - Front Bucket Pair | ICSC019F | \$420.00 |
| Canvas Comfort - Front Bucket and 3/4 Bench | ICSC019F3/4 | \$420.00 |
| Canvas Comfort - Rear | ICSC019R | \$420.00 |

BREATHER KIT

| | | |
|---|----------|----------|
| Universal Twin Manifold Filtered Breather Kit | IDIFFBRE | \$115.00 |
|---|----------|----------|

LISTING
CONTINUED
OVER THE
PAGE

Toyota Landcruiser

79 Series Dual Cab
2013+



Product Description

Part No.

Qty
Req

Retail
ea Inc GST

Please check vehicle date range (if shown) next to product description prior to ordering

SUSPENSION TO SUIT TOYOTA LANDCRUISER 79 SERIES DUAL CAB - 2013+

FRONT SUSPENSION

SHOCK ABSORBER

| | | | | | |
|------------------------------|--|--|-----------------|---|----------|
| Nitro Gas - Performance | | | 12091GR | 2 | \$160.00 |
| Foam Cell - Performance | | | 24091FE | 2 | \$232.00 |
| Foam Cell Pro - Performance | | | 45091FE | 2 | \$319.00 |
| Foam Cell Pro - Professional | | | 45091FEP | 2 | \$319.00 |

COIL SPRINGS

| | Est. Lift | Additional Load | | | |
|------------------|-----------|-----------------|----------------|---|----------|
| Light | 40mm | 0 - 50kg | TOY046A | 1 | \$262.00 |
| Medium | 50mm | 0 - 50kg | TOY046B | 1 | \$262.00 |
| Medium - 4" Lift | 100mm | 0 - 50kg | TOY079B | 1 | \$262.00 |
| Heavy | 50mm | 50 - 110kg | TOY046C | 1 | \$262.00 |

STEERING DAMPER

| | | | | | |
|-----------|--|--|-------------|---|----------|
| Foam Cell | | | 3525 | 1 | \$175.00 |
|-----------|--|--|-------------|---|----------|

CASTER CORRECTION

| | | | | | |
|---|--|--|---------------|---|----------|
| 2° Offset Bush Kit - Polyurethane | | | 1144SK | 1 | \$160.00 |
| Adjustable Offset STD, 2.5, 3.5 Degree - Polyurethane | | | 1144 | 1 | \$160.00 |
| 2° Offset Bush Kit - Rubber | | | 1144RK | 1 | \$160.00 |

STEERING RODS

| | | | | | |
|----------------------|----------------------------|--|---------------|---|----------|
| Adjustable Drag Link | 2007+ Wide Body Model Only | | ADL070 | 1 | \$435.00 |
| Adjustable Track Rod | 2007+ Wide Body Model Only | | ATRO70 | 1 | \$435.00 |

PANHARD ROD

| | | | | | |
|------------------------|----------------|--|--------------------|---|----------|
| Adjustable Panhard Rod | RHD Only | | PANHARD013 | 1 | \$334.00 |
| Adjustable Panhard Rod | 2007+ LHD Only | | PANHARD013L | 1 | \$334.00 |

SWAY BAR

| | | | | | |
|---------------|----------------|--|------------------|---|----------|
| 33mm Sway Bar | Petrol Engines | | ISB789FWP | 1 | \$609.00 |
| 33mm Sway Bar | Diesel Engines | | ISB789FW | 1 | \$609.00 |

SWAY BAR LINK

| | | | | | |
|------------------------|--|--|-----------------|---|---------|
| Extended Sway Bar Link | | | SBEXT001 | 2 | \$30.00 |
|------------------------|--|--|-----------------|---|---------|

COIL SPACER

| | | | | | |
|-------------------|--|--|----------------|---|---------|
| Polyurethane 30mm | | | LC70F30 | 2 | \$44.00 |
|-------------------|--|--|----------------|---|---------|





79 Series Dual Cab
2013+

Toyota Landcruiser

Product Description

Part No.

Qty Req

Retail ea Inc GST

Please check vehicle date range (if shown) next to product description prior to ordering

REAR SUSPENSION

SHOCK ABSORBER

| | | | | | |
|---|--|--|------------------|---|----------|
| Nitro Gas - Comfort | | | 12094GRC | 2 | \$160.00 |
| Nitro Gas - Performance | | | 12094GR | 2 | \$160.00 |
| Foam Cell - Comfort | | | 24094FEC | 2 | \$232.00 |
| Foam Cell - Performance | | | 24094FE | 2 | \$232.00 |
| Foam Cell - Professional | | | 24094FEP | 2 | \$232.00 |
| Foam Cell - Extra Long - Comfort | | | 24094LFEC | 2 | \$262.00 |
| Foam Cell - Extra Long - Performance | | | 24094LFE | 2 | \$262.00 |
| Foam Cell - Extra Long - Professional | | | 24094LFEP | 2 | \$262.00 |
| Foam Cell Pro - Comfort | | | 45094FEC | 2 | \$319.00 |
| Foam Cell Pro - Performance | | | 45094FE | 2 | \$319.00 |
| Foam Cell Pro - Professional | | | 45094FEP | 2 | \$319.00 |
| Foam Cell Pro - Extra Long - Comfort | | | 45094LFEC | 2 | \$334.00 |
| Foam Cell Pro - Extra Long - Performance | | | 45094LFE | 2 | \$334.00 |
| Foam Cell Pro - Extra Long - Professional | | | 45094LFEP | 2 | \$334.00 |

LEAF SPRINGS

| | Est. Lift | Additional Load | | | |
|-------------|-----------|-----------------|----------------|---|----------|
| Light | 50mm | 0 - 250kg | TOY047B | 2 | \$653.00 |
| Medium | 50mm | 0 - 300kg | TOY047C | 2 | \$682.00 |
| Heavy | 50mm | 300kg - 500kg | TOY047D | 2 | \$725.00 |
| Extra Heavy | 50mm | 500kg - GVM | TOY047E | 2 | \$739.00 |

U-BOLTS

| | | | | | |
|-----------------------|---------------------------------|--|----------------|---|---------|
| U-Bolt Kit | | | 416UBK | 2 | \$44.00 |
| U-Bolt Kit Extra Long | Suit TOY047D and TOY047E Spring | | 416UBKL | 2 | \$44.00 |

POLYURETHANE SPRING BUSHES

| | | | | | |
|----------|--|--|---------------|---|---------|
| Bush Kit | | | 1085UK | 1 | \$88.00 |
|----------|--|--|---------------|---|---------|

SWAY BAR

| | | | | | |
|---------------|----------------------------|--|-----------------|---|----------|
| 30mm Sway Bar | Includes Mounting Brackets | | ISB789RW | 1 | \$609.00 |
|---------------|----------------------------|--|-----------------|---|----------|

GREASABLE SHACKLES AND PINS

| | | | | | |
|-------------------|--|--|-------------|---|---------|
| Greasable Shackle | | | 1141 | 2 | \$74.00 |
| Greasable Pin | | | 1142 | 2 | \$44.00 |

HELPER SPRINGS

| | | | | | |
|--------------------------|------------------------|--|------------|---|----------|
| Load Plus Helper Springs | Drum Brake Models Only | | LP9 | 1 | \$234.00 |
|--------------------------|------------------------|--|------------|---|----------|

SUSPENSION KIT - Specify Front Coil Springs When Ordering

| | | | | | |
|-----------------------------|--|--|-------------------|--|-----------|
| Light - Nitro Gas | | | TOY046BKG1 | | \$2375.00 |
| Light - Foam Cell | | | TOY046BKF1 | | \$2664.00 |
| Light - Foam Cell Pro | | | TOY046BKP1 | | \$3012.00 |
| Medium - Nitro Gas | | | TOY046CKG1 | | \$2433.00 |
| Medium - Foam Cell | | | TOY046CKF1 | | \$2723.00 |
| Medium - Foam Cell Pro | | | TOY046CKP1 | | \$3070.00 |
| Heavy - Nitro Gas | | | TOY046DKG1 | | \$2520.00 |
| Heavy - Foam Cell | | | TOY046DKF1 | | \$2867.00 |
| Heavy - Foam Cell Pro | | | TOY046DKP1 | | \$3186.00 |
| Extra Heavy - Foam Cell | | | TOY046EKF1 | | \$2896.00 |
| Extra Heavy - Foam Cell Pro | | | TOY046EKP1 | | \$3215.00 |

SUSPENSION KIT CONTENTS

Shock Absorbers
Coil Springs

Leaf Springs
U-Bolts

Polyurethane Spring Bushes



OPTIONS AVAILABLE FOR THIS VEHICLE 2012+ ONLY - SEE PAGE 389





You have entered Cruiser country!



for a full range of accessories visit our website

www.ironman4x4.com



78 Series Troop Carrier
2007+

Toyota Landcruiser

| Product Description | Part No. | Qty Req | Retail ea Inc GST |
|---|------------------|------------|----------------------|
| ACCESSORIES TO SUIT TOYOTA LANDCRUISER 78 SERIES - 2007+ | | | |
| STEEL WINCH BULL BARS (NO SIDE PLATES ON BAR) | | | |
| Commercial | BBC019E | | \$1648.00 |
| Premium - 60.3mm Tube | BBP019E | | \$2098.00 |
| LOCKSAFE DRAWER SYSTEMS | | | |
| Twin Drawers - 1300mm | ITD1300 | | \$1536.00 |
| Single Drawer - 1300mm | ISD1300 | | \$932.00 |
| Wing Kit - 1300mm (GXL 2008+) | ITDW022 | | \$367.00 |
| RECOVERY POINTS - IRONMAN 4X4 BULL BAR ONLY | | | |
| Recovery Points - 5000kg Rating (Pair) | IRP019 | | \$245.00 |
| SNORKEL | | | |
| Landcruiser 78 Series V8 2007+ | ISNORKEL023 | | \$437.00 |
| PREMIUM UNDERBODY PROTECTION | | | |
| Radiator and Steering Rods | UBP019 | | \$304.00 |
| STEEL ROOF RACKS | | | |
| Cage Style - 1.4m x 1.25m | IRRCAGE14 | | \$812.00 |
| Cage Style - 1.8m x 1.25m | IRRCAGE18 | | \$852.00 |
| Cage Style - 2.2m x 1.25m | IRRCAGE22 | | \$885.00 |
| Rooftop Tent Compatible - 1.8m x 1.25m | IRRTENT18 | | \$812.00 |
| Rooftop Tent Compatible - 2.2m x 1.25m | IRRTENT22 | | \$852.00 |
| Trade Style - 1.8m x 1.25m (Open end) | IRRTADE18 | | \$812.00 |
| Trade Style - 2.2m x 1.25m (Open end) | IRRTADE22 | | \$846.00 |
| ALLOY ROOF RACKS | | | |
| Cage Style - 1.4m x 1.25m | IRRCAGE14-ALLOY | | \$1028.00 |
| Cage Style - 1.8m x 1.25m | IRRCAGE18-ALLOY | | \$1201.00 |
| Cage Style - 2.2m x 1.25m | IRRCAGE22-ALLOY | | \$1267.00 |
| Trade Style - 1.4m x 1.25m (Open end) | IRROPEN14-ALLOY | | \$1015.00 |
| Trade Style - 1.8m x 1.25m (Open end) | IRRTADE18-ALLOY | | \$1183.00 |
| Trade Style - 2.2m x 1.25m (Open end) | IRRTADE22-ALLOY | | \$1235.00 |
| Flat Rack - 1.8m x 1.25m | IRRTFLAT18-ALLOY | | \$1167.00 |
| STEEL AND ALLOY ROOF RACK - MOUNT KITS | | | |
| Gutter Mount Feet - 210mm (8 Feet) | IRRFEE210 | | \$228.00 |
| SEAT COVER | | | |
| Canvas Comfort - Front Bucket Pair | ICSC019F | | \$420.00 |
| Canvas Comfort - Front Bucket and 3/4 Bench | ICSC019F3/4 | | \$420.00 |
| BREATHING KIT | | | |
| Universal Twin Manifold Filtered Breather Kit | IDIFFBRE | | \$115.00 |

Toyota Landcruiser

78 Series
2007+



Product Description

Part No.

Qty
Req

Retail
ea Inc GST

Please check vehicle date range (if shown) next to product description prior to ordering

SUSPENSION TO SUIT TOYOTA LANDCRUISER 78 SERIES - 2007+

FRONT SUSPENSION

SHOCK ABSORBER

| | | | | | |
|------------------------------|--|--|-----------------|---|----------|
| Nitro Gas - Performance | | | 12091GR | 2 | \$160.00 |
| Foam Cell - Performance | | | 24091FE | 2 | \$232.00 |
| Foam Cell Pro - Performance | | | 45091FE | 2 | \$319.00 |
| Foam Cell Pro - Professional | | | 45091FEP | 2 | \$319.00 |

COIL SPRINGS

| | Est. Lift | Additional Load | | | |
|------------------|-----------|-----------------|----------------|---|----------|
| Light | 40mm | 0 - 50kg | TOY046A | 1 | \$262.00 |
| Medium | 50mm | 0 - 50kg | TOY046B | 1 | \$262.00 |
| Medium - 4" Lift | 100mm | 0 - 50kg | TOY079B | 1 | \$262.00 |
| Heavy | 50mm | 50 - 110kg | TOY046C | 1 | \$262.00 |

STEERING DAMPER

| | | | | | |
|-----------|-------|--|-------------|---|----------|
| Foam Cell | 2007+ | | 3525 | 1 | \$175.00 |
|-----------|-------|--|-------------|---|----------|

CASTER CORRECTION

| | | | | | |
|---|--|--|---------------|---|----------|
| 2° Offset Bush Kit - Polyurethane | | | 1144SK | 1 | \$160.00 |
| Adjustable Offset STD, 2.5, 3.5 Degree - Polyurethane | | | 1144 | 1 | \$160.00 |
| 2° Offset Bush Kit - Rubber | | | 1144RK | 1 | \$160.00 |

STEERING RODS

| | | | | | |
|----------------------|----------------------------|--|---------------|---|----------|
| Adjustable Drag Link | 2007+ Wide Body Model Only | | ADL070 | 1 | \$435.00 |
| Adjustable Track Rod | 2007+ Wide Body Model Only | | ATRO70 | 1 | \$435.00 |

PANHARD ROD

| | | | | | |
|------------------------|----------------|--|--------------------|---|----------|
| Adjustable Panhard Rod | 2007+ RHD Only | | PANHARD013 | 1 | \$334.00 |
| Adjustable Panhard Rod | 2007+ LHD Only | | PANHARD013L | 1 | \$334.00 |

SWAY BAR

| | | | | | |
|---------------|-----------------------|--|------------------|---|----------|
| 33mm Sway Bar | Narrow Body 1999-2007 | | ISB789F | 1 | \$609.00 |
| 33mm Sway Bar | Petrol Engines 2007+ | | ISB789FWP | 1 | \$609.00 |
| 33mm Sway Bar | Diesel Engines 2007+ | | ISB789FW | 1 | \$609.00 |

SWAY BAR LINK

| | | | | | |
|------------------------|--|--|-----------------|---|---------|
| Extended Sway Bar Link | | | SBEXT001 | 2 | \$30.00 |
|------------------------|--|--|-----------------|---|---------|

COIL SPACER

| | | | | | |
|-------------------|--|--|----------------|---|---------|
| Polyurethane 30mm | | | LC70F30 | 2 | \$44.00 |
|-------------------|--|--|----------------|---|---------|



78 Series
2007+

Toyota Landcruiser

Product Description

Part No.

**Qty
Req**

**Retail
ea Inc GST**

Please check vehicle date range (if shown) next to product description prior to ordering

REAR SUSPENSION

SHOCK ABSORBER

| | | | | | |
|---|--|--|------------------|---|----------|
| Nitro Gas - Comfort | | | 12094GRC | 2 | \$160.00 |
| Nitro Gas - Performance | | | 12094GR | 2 | \$160.00 |
| Foam Cell - Comfort | | | 24094FEC | 2 | \$232.00 |
| Foam Cell - Performance | | | 24094FE | 2 | \$232.00 |
| Foam Cell - Professional | | | 24094FEP | 2 | \$232.00 |
| Foam Cell - Extra Long - Comfort | | | 24094LFEC | 2 | \$262.00 |
| Foam Cell - Extra Long - Performance | | | 24094LFE | 2 | \$262.00 |
| Foam Cell - Extra Long - Professional | | | 24094LFEP | 2 | \$262.00 |
| Foam Cell Pro - Comfort | | | 45094FEC | 2 | \$319.00 |
| Foam Cell Pro - Performance | | | 45094FE | 2 | \$319.00 |
| Foam Cell Pro - Professional | | | 45094FEP | 2 | \$319.00 |
| Foam Cell Pro - Extra Long - Comfort | | | 45094LFEC | 2 | \$334.00 |
| Foam Cell Pro - Extra Long - Performance | | | 45094LFE | 2 | \$334.00 |
| Foam Cell Pro - Extra Long - Professional | | | 45094LFEP | 2 | \$334.00 |

LEAF SPRINGS

| | Est. Lift | Additional Load | | | |
|-------------|-----------|-----------------|----------------|---|----------|
| Light | 50mm | 0 - 150kg | TOY047A | 2 | \$609.00 |
| Medium | 50mm | 0 - 250kg | TOY047B | 2 | \$653.00 |
| Heavy | 50mm | 250 - 400kg | TOY047C | 2 | \$682.00 |
| Extra Heavy | 50mm | 400kg - 600kg | TOY047D | 2 | \$725.00 |
| Super Heavy | 50mm | 600kg - GVM | TOY047E | 2 | \$739.00 |

U-BOLTS

| | | | | | |
|-----------------------|---------------------------------|--|----------------|---|---------|
| U-Bolt Kit | | | 416UBK | 2 | \$44.00 |
| U-Bolt Kit Extra Long | Suit TOY047D and TOY047E Spring | | 416UBKL | 2 | \$44.00 |

POLYURETHANE SPRING BUSHES

| | | | | | |
|----------|--|--|---------------|---|---------|
| Bush Kit | | | 1084UK | 1 | \$88.00 |
|----------|--|--|---------------|---|---------|

SWAY BAR

| | | | | | |
|--|------------|--|-----------------|---|----------|
| 30mm Sway Bar (Includes Mounting Brackets) | 2007+ Only | | ISB789RW | 1 | \$609.00 |
|--|------------|--|-----------------|---|----------|

GREASABLE SHACKLES AND PINS

| | | | | | |
|-------------------|--|--|-------------|---|---------|
| Greasable Shackle | | | 1141 | 2 | \$74.00 |
| Greasable Pin | | | 1142 | 2 | \$44.00 |

HELPER SPRINGS

| | | | | | |
|--------------------------|------------------------|--|------------|---|----------|
| Load Plus Helper Springs | Drum Brake Models Only | | LP9 | 1 | \$234.00 |
|--------------------------|------------------------|--|------------|---|----------|

SUSPENSION KIT - Specify Front Coil Springs When Ordering

| | | | |
|-----------------------------|--|------------------|-----------|
| Light - Nitro Gas | | TOY046AKG | \$2288.00 |
| Light - Foam Cell | | TOY046AKF | \$2577.00 |
| Light - Foam Cell Pro | | TOY046AKP | \$2925.00 |
| Medium - Nitro Gas | | TOY046BKG | \$2375.00 |
| Medium - Foam Cell | | TOY046BKF | \$2664.00 |
| Medium - Foam Cell Pro | | TOY046BKP | \$3012.00 |
| Heavy - Nitro Gas | | TOY046CKG | \$2433.00 |
| Heavy - Foam Cell | | TOY046CKF | \$2723.00 |
| Heavy - Foam Cell Pro | | TOY046CKP | \$3070.00 |
| Extra Heavy - Nitro Gas | | TOY046DKG | \$2520.00 |
| Extra Heavy - Foam Cell | | TOY046DKF | \$2867.00 |
| Extra Heavy - Foam Cell Pro | | TOY046DKP | \$3186.00 |
| Super Heavy - Foam Cell | | TOY046EKF | \$2896.00 |
| Super Heavy - Foam Cell Pro | | TOY046EKP | \$3215.00 |

SUSPENSION KIT CONTENTS

| | | |
|-----------------|--------------|----------------------------|
| Shock Absorbers | Leaf Springs | Polyurethane Spring Bushes |
| Coil Springs | U-Bolts | |



OPTIONS AVAILABLE FOR THIS VEHICLE 2007+ ONLY - SEE PAGE 390





Lifes a Beach





78 Series
1999 to 2007

Toyota Landcruiser

Product Description

Part No.

Qty
Req

Retail
ea Inc GST

Please check vehicle date range (if shown) next to product description prior to ordering

ACCESSORIES TO SUIT TOYOTA LANDCRUISER 78 SERIES - 1999-2007

STEEL WINCH BULL BARS (NO SIDE PLATES ON BAR)

| | | |
|-------------------|---------|-----------|
| Commercial Deluxe | BBCD018 | \$2345.00 |
|-------------------|---------|-----------|

LOCKSAFE DRAWER SYSTEMS

| | | |
|--|---------|-----------|
| Twin Drawers - 1300mm Troop Carrier LC78 | ITD1300 | \$1536.00 |
|--|---------|-----------|

| | | |
|------------------------|---------|----------|
| Single Drawer - 1300mm | ISD1300 | \$932.00 |
|------------------------|---------|----------|

SNORKEL

| | | |
|-----------------------------|-------------|----------|
| Landcruiser 4.2L 1HZ Diesel | ISNORKEL009 | \$437.00 |
|-----------------------------|-------------|----------|

STEEL ROOF RACKS

| | | |
|---------------------------|-----------|----------|
| Cage Style - 1.4m x 1.25m | IRRCAGE14 | \$812.00 |
|---------------------------|-----------|----------|

| | | |
|---------------------------|-----------|----------|
| Cage Style - 1.8m x 1.25m | IRRCAGE18 | \$852.00 |
|---------------------------|-----------|----------|

| | | |
|---------------------------|-----------|----------|
| Cage Style - 2.2m x 1.25m | IRRCAGE22 | \$885.00 |
|---------------------------|-----------|----------|

| | | |
|--|-----------|----------|
| Rooftop Tent Compatible - 1.8m x 1.25m | IRRTENT18 | \$812.00 |
|--|-----------|----------|

| | | |
|--|-----------|----------|
| Rooftop Tent Compatible - 2.2m x 1.25m | IRRTENT22 | \$852.00 |
|--|-----------|----------|

| | | |
|---------------------------------------|------------|----------|
| Trade Style - 1.8m x 1.25m (Open end) | IRRTRADE18 | \$812.00 |
|---------------------------------------|------------|----------|

| | | |
|---------------------------------------|------------|----------|
| Trade Style - 2.2m x 1.25m (Open end) | IRRTRADE22 | \$846.00 |
|---------------------------------------|------------|----------|

ALLOY ROOF RACKS

| | | |
|---------------------------|-----------------|-----------|
| Cage Style - 1.4m x 1.25m | IRRCAGE14-ALLOY | \$1028.00 |
|---------------------------|-----------------|-----------|

| | | |
|---------------------------|-----------------|-----------|
| Cage Style - 1.8m x 1.25m | IRRCAGE18-ALLOY | \$1201.00 |
|---------------------------|-----------------|-----------|

| | | |
|---------------------------|-----------------|-----------|
| Cage Style - 2.2m x 1.25m | IRRCAGE22-ALLOY | \$1267.00 |
|---------------------------|-----------------|-----------|

| | | |
|---------------------------------------|-----------------|-----------|
| Trade Style - 1.4m x 1.25m (Open end) | IRROPEN14-ALLOY | \$1015.00 |
|---------------------------------------|-----------------|-----------|

| | | |
|---------------------------------------|------------------|-----------|
| Trade Style - 1.8m x 1.25m (Open end) | IRRTRADE18-ALLOY | \$1183.00 |
|---------------------------------------|------------------|-----------|

| | | |
|---------------------------------------|------------------|-----------|
| Trade Style - 2.2m x 1.25m (Open end) | IRRTRADE22-ALLOY | \$1235.00 |
|---------------------------------------|------------------|-----------|

| | | |
|--------------------------|------------------|-----------|
| Flat Rack - 1.8m x 1.25m | IRRTFLAT18-ALLOY | \$1167.00 |
|--------------------------|------------------|-----------|

STEEL AND ALLOY ROOF RACK - MOUNT KITS

| | | |
|------------------------------------|------------|----------|
| Gutter Mount Feet - 210mm (8 Feet) | IRRFEET210 | \$228.00 |
|------------------------------------|------------|----------|

BREATHER KIT

| | | |
|---|----------|----------|
| Universal Twin Manifold Filtered Breather Kit | IDIFFBRE | \$115.00 |
|---|----------|----------|

LISTING
CONTINUED
OVER THE
PAGE



Toyota Landcruiser

78 Series
1999 to 2007



Product Description

Part No.

Qty
Req

Retail
ea Inc GST

Please check vehicle date range (if shown) next to product description prior to ordering

SUSPENSION TO SUIT TOYOTA LANDCRUISER 78 SERIES - 1999-2007

FRONT SUSPENSION

SHOCK ABSORBER

| | | | | | |
|------------------------------|--|--|-----------------|---|----------|
| Nitro Gas - Performance | | | 12091GR | 2 | \$160.00 |
| Foam Cell - Performance | | | 24091FE | 2 | \$232.00 |
| Foam Cell Pro - Performance | | | 45091FE | 2 | \$319.00 |
| Foam Cell Pro - Professional | | | 45091FEP | 2 | \$319.00 |

COIL SPRINGS

| | Est. Lift | Additional Load | | | |
|------------------|-----------|-----------------|----------------|---|----------|
| Light | 40mm | 0 - 50kg | TOY046A | 1 | \$262.00 |
| Medium | 50mm | 0 - 50kg | TOY046B | 1 | \$262.00 |
| Medium - 4" Lift | 100mm | 0 - 50kg | TOY079B | 1 | \$262.00 |
| Heavy | 50mm | 50 - 110kg | TOY046C | 1 | \$262.00 |

STEERING DAMPER

| | | | | |
|-----------|-----------|-------------|---|----------|
| Foam Cell | 1999-2006 | 3524 | 1 | \$175.00 |
| Foam Cell | 2007+ | 3525 | 1 | \$175.00 |

CASTER CORRECTION

| | | | | |
|---|--|---------------|---|----------|
| 2° Offset Bush Kit - Polyurethane | | 1144SK | 1 | \$160.00 |
| Adjustable Offset STD, 2.5, 3.5 Degree - Polyurethane | | 1144 | 1 | \$160.00 |
| 2° Offset Bush Kit - Rubber | | 1144RK | 1 | \$160.00 |

PANHARD ROD

| | | | | |
|------------------------|----------------|--------------------|---|----------|
| Adjustable Panhard Rod | 2007+ RHD Only | PANHARD013 | 1 | \$334.00 |
| Adjustable Panhard Rod | 2007+ LHD Only | PANHARD013L | 1 | \$334.00 |

SWAY BAR

| | | | | |
|---------------|-----------------------|------------------|---|----------|
| 33mm Sway Bar | Narrow Body 1999-2007 | ISB789F | 1 | \$609.00 |
| 33mm Sway Bar | Petrol Engines 2007+ | ISB789FWP | 1 | \$609.00 |
| 33mm Sway Bar | Diesel Engines 2007+ | ISB789FW | 1 | \$609.00 |

SWAY BAR LINK

| | | | | |
|------------------------|--|-----------------|---|---------|
| Extended Sway Bar Link | | SBEXT001 | 2 | \$30.00 |
|------------------------|--|-----------------|---|---------|

COIL SPACER

| | | | | |
|-------------------|--|----------------|---|---------|
| Polyurethane 30mm | | LC70F30 | 2 | \$44.00 |
|-------------------|--|----------------|---|---------|





78 Series
1999 to 2007

SUSPENSION TO SUIT

Toyota Landcruiser

Product Description

Part No.

**Qty
Req**

**Retail
ea Inc GST**

Please check vehicle date range (if shown) next to product description prior to ordering

REAR SUSPENSION

SHOCK ABSORBER

| | | | | | |
|---|--|--|------------------|---|----------|
| Nitro Gas - Comfort | | | 12094GRC | 2 | \$160.00 |
| Nitro Gas - Performance | | | 12094GR | 2 | \$160.00 |
| Foam Cell - Comfort | | | 24094FEC | 2 | \$232.00 |
| Foam Cell - Performance | | | 24094FE | 2 | \$232.00 |
| Foam Cell - Professional | | | 24094FEP | 2 | \$232.00 |
| Foam Cell - Extra Long - Comfort | | | 24094LFEC | 2 | \$262.00 |
| Foam Cell - Extra Long - Performance | | | 24094LFE | 2 | \$262.00 |
| Foam Cell - Extra Long - Professional | | | 24094LFEP | 2 | \$262.00 |
| Foam Cell Pro - Comfort | | | 45094FEC | 2 | \$319.00 |
| Foam Cell Pro - Performance | | | 45094FE | 2 | \$319.00 |
| Foam Cell Pro - Professional | | | 45094FEP | 2 | \$319.00 |
| Foam Cell Pro - Extra Long - Comfort | | | 45094LFEC | 2 | \$334.00 |
| Foam Cell Pro - Extra Long - Performance | | | 45094LFE | 2 | \$334.00 |
| Foam Cell Pro - Extra Long - Professional | | | 45094LFEP | 2 | \$334.00 |

LEAF SPRINGS

| | Est. Lift | Additional Load | | | |
|-------------|-----------|-----------------|----------------|---|----------|
| Light | 50mm | 0 - 150kg | TOY047A | 2 | \$609.00 |
| Medium | 50mm | 0 - 250kg | TOY047B | 2 | \$653.00 |
| Heavy | 50mm | 250 - 400kg | TOY047C | 2 | \$682.00 |
| Extra Heavy | 50mm | 400kg - 600kg | TOY047D | 2 | \$725.00 |
| Super Heavy | 50mm | 600kg - GVM | TOY047E | 2 | \$739.00 |

U-BOLTS

| | | | | | |
|-----------------------|---------------------------------|--|----------------|---|---------|
| U-Bolt Kit | | | 416UBK | 2 | \$44.00 |
| U-Bolt Kit Extra Long | Suit TOY047D and TOY047E Spring | | 416UBKL | 2 | \$44.00 |

POLYURETHANE SPRING BUSHES

| | | | | | |
|----------|--|--|---------------|---|---------|
| Bush Kit | | | 1084UK | 1 | \$88.00 |
|----------|--|--|---------------|---|---------|

SWAY BAR

| | | | | | |
|--|------------|--|-----------------|---|----------|
| 30mm Sway Bar (Includes Mounting Brackets) | 2007+ Only | | ISB789RW | 1 | \$609.00 |
|--|------------|--|-----------------|---|----------|

GREASABLE SHACKLES AND PINS

| | | | | | |
|-------------------|--|--|-------------|---|---------|
| Greasable Shackle | | | 1141 | 2 | \$74.00 |
| Greasable Pin | | | 1142 | 2 | \$44.00 |

HELPER SPRINGS

| | | | | | |
|--------------------------|------------------------|--|------------|---|----------|
| Load Plus Helper Springs | Drum Brake Models Only | | LP9 | 1 | \$234.00 |
|--------------------------|------------------------|--|------------|---|----------|

SUSPENSION KIT - Specify Front Coil Springs When Ordering

| | | | | | |
|-----------------------------|--|--|------------------|--|-----------|
| Light - Nitro Gas | | | TOY046AKG | | \$2288.00 |
| Light - Foam Cell | | | TOY046AKF | | \$2577.00 |
| Light - Foam Cell Pro | | | TOY046AKP | | \$2925.00 |
| Medium - Nitro Gas | | | TOY046BKG | | \$2375.00 |
| Medium - Foam Cell | | | TOY046BKF | | \$2664.00 |
| Medium - Foam Cell Pro | | | TOY046BKP | | \$3012.00 |
| Heavy - Nitro Gas | | | TOY046CKG | | \$2433.00 |
| Heavy - Foam Cell | | | TOY046CKF | | \$2723.00 |
| Heavy - Foam Cell Pro | | | TOY046CKP | | \$3070.00 |
| Extra Heavy - Nitro Gas | | | TOY046DKG | | \$2520.00 |
| Extra Heavy - Foam Cell | | | TOY046DKF | | \$2867.00 |
| Extra Heavy - Foam Cell Pro | | | TOY046DKP | | \$3186.00 |
| Super Heavy - Foam Cell | | | TOY046EKF | | \$2896.00 |
| Super Heavy - Foam Cell Pro | | | TOY046EKP | | \$3215.00 |

SUSPENSION KIT CONTENTS

| | | |
|-----------------|--------------|----------------------------|
| Shock Absorbers | Leaf Springs | Polyurethane Spring Bushes |
| Coil Springs | U-Bolts | |



Alu-Cab™

ULTIMATE OVERLAND PRODUCTS



Built for adventure!

for a full range of alu-cab products visit our website

www.ironman4x4.com

distributed by



76 Series
2007+

Toyota Landcruiser

| Product Description | Part No. | Qty Req | Retail ea Inc GST |
|---|------------------|------------|----------------------|
| STEEL WINCH BULL BARS (NO SIDE PLATES ON BAR) | | | |
| Commercial | BBC019E | | \$1648.00 |
| Premium - 60.3mm Tube | BBP019E | | \$2098.00 |
| STEEL SIDE STEPS AND RAILS | | | |
| Side Steps | SS015 | | \$1006.00 |
| Side Steps and Rails | SSR015 | | \$1207.00 |
| Premium Side Steps and Rails - 60.3mm Tube | SSRP015 | | \$1334.00 |
| LOCKSAFE DRAWER SYSTEMS | | | |
| Twin Drawers - 900mm | ITD900 | | \$1298.00 |
| Single Drawer - 900mm | ISD900 | | \$802.00 |
| Wing Kit - 900mm (76 Series GXL) | ITDW009 | | \$283.00 |
| RECOVERY POINTS - IRONMAN 4X4 BULL BAR ONLY | | | |
| Recovery Points - 5000kg Rating (Pair) | IRP019 | | \$245.00 |
| SNORKEL | | | |
| Landcruiser V8 2007+ | ISNORKEL023 | | \$437.00 |
| <i>*Does not suit vehicle with DPF</i> | | | |
| PREMIUM UNDERBODY PROTECTION | | | |
| Radiator and Steering Rods | UBP019 | | \$304.00 |
| LONG RANGE FUEL TANK | | | |
| 160L* Diesel - 76 Series up to 11/2012 only | TANK001 | | \$1180.00 |
| <i>* Usable volume may differ to the stated tank capacity</i> | | | |
| STEEL ROOF RACKS | | | |
| Cage Style - 1.4m x 1.25m | IRRCAGE14 | | \$812.00 |
| Cage Style - 1.8m x 1.25m | IRRCAGE18 | | \$852.00 |
| Cage Style - 2.2m x 1.25m | IRRCAGE22 | | \$885.00 |
| Rooftop Tent Compatible - 1.8m x 1.25m | IRRTENT18 | | \$812.00 |
| Rooftop Tent Compatible - 2.2m x 1.25m | IRRTENT22 | | \$852.00 |
| Trade Style - 1.8m x 1.25m (Open end) | IRRTRADE18 | | \$812.00 |
| Trade Style - 2.2m x 1.25m (Open end) | IRRTRADE22 | | \$846.00 |
| ALLOY ROOF RACKS | | | |
| Cage Style - 1.4m x 1.25m | IRRCAGE14-ALLOY | | \$1028.00 |
| Cage Style - 1.8m x 1.25m | IRRCAGE18-ALLOY | | \$1201.00 |
| Cage Style - 2.2m x 1.25m | IRRCAGE22-ALLOY | | \$1267.00 |
| Trade Style - 1.8m x 1.25m (Open end) | IRRTRADE18-ALLOY | | \$1183.00 |
| Trade Style - 2.2m x 1.25m (Open end) | IRRTRADE22-ALLOY | | \$1235.00 |
| Flat Rack - 1.8m x 1.25m | IRRTFLAT18-ALLOY | | \$1167.00 |
| STEEL AND ALLOY ROOF RACK - MOUNT KITS | | | |
| Gutter Mount Feet - 125mm (8 Feet) | IRRFEET125 | | \$207.00 |
| SEAT COVER | | | |
| Canvas Comfort - Front Bucket Pair | ICSC019F | | \$420.00 |
| Canvas Comfort - Rear | ICSC019R | | \$420.00 |
| BREATHER KIT | | | |
| Universal Twin Manifold Filtered Breather Kit | IDIFFBRE | | \$115.00 |

 LISTING
CONTINUED
OVER THE
PAGE

Toyota Landcruiser

76 Series
2007+



Product Description

Part No.

Qty
Req

Retail
ea Inc GST

Please check vehicle date range (if shown) next to product description prior to ordering

SUSPENSION TO SUIT TOYOTA LANDCRUISER 76 SERIES - 2007+

FRONT SUSPENSION

SHOCK ABSORBER

| | | | | | |
|------------------------------|--|--|-----------------|---|----------|
| Nitro Gas - Performance | | | 12091GR | 2 | \$160.00 |
| Foam Cell - Performance | | | 24091FE | 2 | \$232.00 |
| Foam Cell Pro - Performance | | | 45091FE | 2 | \$319.00 |
| Foam Cell Pro - Professional | | | 45091FEP | 2 | \$319.00 |

COIL SPRINGS

| | Est. Lift | Additional Load | | | |
|------------------|-----------|-----------------|----------------|---|----------|
| Light | 40mm | 0 - 50kg | TOY046A | 1 | \$262.00 |
| Medium | 50mm | 0 - 50kg | TOY046B | 1 | \$262.00 |
| Medium - 4" Lift | 100mm | 0 - 50kg | TOY079B | 1 | \$262.00 |
| Heavy | 50mm | 50 - 110kg | TOY046C | 1 | \$262.00 |

STEERING DAMPER

| | | | | | |
|-----------|--|--|-------------|---|----------|
| Foam Cell | | | 3525 | 1 | \$175.00 |
|-----------|--|--|-------------|---|----------|

CASTER CORRECTION

| | | | | | |
|---|--|--|---------------|---|----------|
| 2° Offset Bush Kit - Polyurethane | | | 1144SK | 1 | \$160.00 |
| Adjustable Offset STD, 2.5, 3.5 Degree - Polyurethane | | | 1144 | 1 | \$160.00 |
| 2° Offset Bush Kit - Rubber | | | 1144RK | 1 | \$160.00 |

PANHARD ROD

| | | | | | |
|------------------------|----------------|--|--------------------|---|----------|
| Adjustable Panhard Rod | RHD Only | | PANHARD013 | 1 | \$334.00 |
| Adjustable Panhard Rod | 2007+ LHD Only | | PANHARD013L | 1 | \$334.00 |

SWAY BAR

| | | | | | |
|---------------|----------------|--|------------------|---|----------|
| 33mm Sway Bar | Petrol Engines | | ISB789FWP | 1 | \$609.00 |
| 33mm Sway Bar | Diesel Engines | | ISB789FW | 1 | \$609.00 |

SWAY BAR LINK

| | | | | | |
|------------------------|--|--|-----------------|---|---------|
| Extended Sway Bar Link | | | SBEXT001 | 2 | \$30.00 |
|------------------------|--|--|-----------------|---|---------|

COIL SPACER

| | | | | | |
|-------------------|--|--|----------------|---|---------|
| Polyurethane 30mm | | | LC70F30 | 2 | \$44.00 |
|-------------------|--|--|----------------|---|---------|





76 Series
2007+

Toyota Landcruiser

| Product Description | Part No. | Qty Req | Retail ea Inc GST |
|---|----------------------------|-----------------|----------------------|
| <i>Please check vehicle date range (if shown) next to product description prior to ordering</i> | | | |
| REAR SUSPENSION | | | |
| SHOCK ABSORBER | | | |
| Nitro Gas - Comfort | 12094GRC | 2 | \$160.00 |
| Nitro Gas - Performance | 12094GR | 2 | \$160.00 |
| Foam Cell - Comfort | 24094FEC | 2 | \$232.00 |
| Foam Cell - Performance | 24094FE | 2 | \$232.00 |
| Foam Cell - Professional | 24094FEP | 2 | \$232.00 |
| Foam Cell - Extra Long - Comfort | 24094LFEC | 2 | \$262.00 |
| Foam Cell - Extra Long - Performance | 24094LFE | 2 | \$262.00 |
| Foam Cell - Extra Long - Professional | 24094LFEP | 2 | \$262.00 |
| Foam Cell Pro - Comfort | 45094FEC | 2 | \$319.00 |
| Foam Cell Pro - Performance | 45094FE | 2 | \$319.00 |
| Foam Cell Pro - Professional | 45094FEP | 2 | \$319.00 |
| Foam Cell Pro - Extra Long - Comfort | 45094LFEC | 2 | \$334.00 |
| Foam Cell Pro - Extra Long - Performance | 45094LFE | 2 | \$334.00 |
| Foam Cell Pro - Extra Long - Professional | 45094LFEP | 2 | \$334.00 |
| LEAF SPRINGS | | | |
| | Est. Lift | Additional Load | |
| Medium | 50mm | 0 - 300kg | TOY062B 2 \$609.00 |
| Heavy | 50mm | 300 - 600kg | TOY062C 2 \$638.00 |
| Extra Heavy | 50mm | 600kg - GVM | TOY062D 2 \$653.00 |
| U-BOLTS | | | |
| U-Bolt Kit | 416UBK | 2 | \$44.00 |
| POLYURETHANE SPRING BUSHES | | | |
| Bush Kit | 1085UK | 1 | \$88.00 |
| GREASABLE SHACKLES AND PINS | | | |
| Greasable Shackle | 1141-1 | 2 | \$74.00 |
| Greasable Shackle Extended 20mm | 1141 | 2 | \$74.00 |
| Greasable Pin | 1142 | 2 | \$44.00 |
| SWAY BAR | | | |
| 30mm Sway Bar | Includes Mounting Brackets | ISB789RW | 1 \$609.00 |
| HELPER SPRINGS | | | |
| Load Plus Helper Springs | | LP4 | 1 \$165.00 |

SUSPENSION KIT - Specify Front Coil Springs When Ordering

| | | |
|-----------------------------|-----------|-----------|
| Medium - Nitro Gas | TOY062BKG | \$2288.00 |
| Medium - Foam Cell | TOY062BKF | \$2577.00 |
| Medium - Foam Cell Pro | TOY062BKP | \$2925.00 |
| Heavy - Nitro Gas | TOY062CKG | \$2347.00 |
| Heavy - Foam Cell | TOY062CKF | \$2636.00 |
| Heavy - Foam Cell Pro | TOY062CKP | \$3272.00 |
| Extra Heavy - Nitro Gas | TOY062DKG | \$2375.00 |
| Extra Heavy - Foam Cell | TOY062DKF | \$2664.00 |
| Extra Heavy - Foam Cell Pro | TOY062DKP | \$3302.00 |

SUSPENSION KIT CONTENTS

| | | |
|-----------------|--------------|----------------------------|
| Shock Absorbers | Coil Springs | Polyurethane Spring Bushes |
| Leaf Springs | U-Bolts | |

Toyota Landcruiser

75 Series
1984 to 1999



Product Description

Part No.

Qty
Req

Retail
ea Inc GST

Please check vehicle date range (if shown) next to product description prior to ordering

ACCESSORIES TO SUIT TOYOTA LANDCRUISER 75 SERIES - 1984-1999

STEEL WINCH BULL BARS (NO SIDE PLATES ON BAR)

Commercial Deluxe

BBCD018

\$2345.00

LOCKSAFE DRAWER SYSTEMS

Twin Drawers - 1300mm

ITD1300

\$1536.00

Single Drawer - 1300mm

ISD1300

\$932.00

SNORKEL

Landcruiser 4.2L 1HZ Diesel

ISNORKEL009

\$437.00

BREATHER KIT

Universal Twin Manifold Filtered Breather Kit

IDIFFBRE

\$115.00



75 Series
1984 to 1999

Toyota Landcruiser

Product Description

Part No.

Qty
ReqRetail
ea Inc GST

Please check vehicle date range (if shown) next to product description prior to ordering

SUSPENSION TO SUIT TOYOTA LANDCRUISER 75 SERIES - 1984-1999

FRONT SUSPENSION

SHOCK ABSORBER

| | | | | | |
|-----------------------------|--|--|-----------------|---|----------|
| Nitro Gas - Comfort | | | 12637GRC | 2 | \$160.00 |
| Nitro Gas - Performance | | | 12637GR | 2 | \$160.00 |
| Foam Cell - Comfort | | | 24637FEC | 2 | \$232.00 |
| Foam Cell - Performance | | | 24637FE | 2 | \$232.00 |
| Foam Cell Pro - Comfort | | | 45637FEC | 2 | \$319.00 |
| Foam Cell Pro - Performance | | | 45637FE | 2 | \$319.00 |

LEAF SPRINGS

| | Est. Lift | Additional Load | | | |
|--------|-----------|-----------------|----------------|---|----------|
| Medium | 50mm | 0 - 50kg | TOY008B | 2 | \$392.00 |
| Heavy | 50mm | 50 - 100kg | TOY008C | 2 | \$421.00 |

STEERING DAMPER

| | | | | | |
|-----------|--|--|-------------|---|----------|
| Foam Cell | | | 3524 | 1 | \$175.00 |
|-----------|--|--|-------------|---|----------|

U-BOLTS

| | | | | | |
|------------|--|--|---------------|---|---------|
| U-Bolt Kit | | | 436UBK | 2 | \$44.00 |
|------------|--|--|---------------|---|---------|

POLYURETHANE SPRING BUSHES

| | | | | | |
|----------|--|--|--------------|---|---------|
| Bush Kit | | | 719UK | 1 | \$74.00 |
|----------|--|--|--------------|---|---------|

GREASABLE SHACKLES AND PINS

| | | | | | |
|-------------------|-----------------|--|--------------|---|---------|
| Greasable Shackle | Left Hand Side | | 348LH | 1 | \$74.00 |
| Greasable Shackle | Right Hand Side | | 348RH | 1 | \$74.00 |
| Greasable Pin | | | 351 | 2 | \$44.00 |

REAR SUSPENSION

SHOCK ABSORBER

| | | | | | |
|------------------------------|--|--|-----------------|---|----------|
| Nitro Gas - Comfort | | | 12081GRC | 2 | \$160.00 |
| Nitro Gas - Performance | | | 12081GR | 2 | \$160.00 |
| Foam Cell - Comfort | | | 24081FEC | 2 | \$232.00 |
| Foam Cell - Performance | | | 24081FE | 2 | \$232.00 |
| Foam Cell - Professional | | | 24081FEP | 2 | \$232.00 |
| Foam Cell Pro - Comfort | | | 45081FEC | 2 | \$319.00 |
| Foam Cell Pro - Performance | | | 45081FE | 2 | \$319.00 |
| Foam Cell Pro - Professional | | | 45081FEP | 2 | \$319.00 |

LEAF SPRINGS

| | Est. Lift | Additional Load | | | |
|-------------|-----------|-----------------|----------------|---|----------|
| Medium | 50mm | 0 - 200kg | TOY009B | 2 | \$551.00 |
| Heavy | 50mm | 200 - 400kg | TOY009C | 2 | \$566.00 |
| Extra Heavy | 50mm | 400 - 600kg | TOY009D | 2 | \$580.00 |
| Super Heavy | 50mm | 600kg - GVM | TOY009E | 2 | \$609.00 |

U-BOLTS

| | | | | | |
|------------|--|--|---------------|---|---------|
| U-Bolt Kit | | | 416UBK | 2 | \$44.00 |
|------------|--|--|---------------|---|---------|

POLYURETHANE SPRING BUSHES

| | | | | | |
|----------|--|--|--------------|---|---------|
| Bush Kit | | | 720UK | 1 | \$74.00 |
|----------|--|--|--------------|---|---------|

GREASABLE SHACKLES AND PINS

| | | | | | |
|-------------------|-----------------|--|--------------|---|---------|
| Greasable Shackle | Left Hand Side | | 353LH | 1 | \$74.00 |
| Greasable Shackle | Right Hand Side | | 353RH | 1 | \$74.00 |
| Greasable Pin | | | 354 | 2 | \$44.00 |

HELPER SPRINGS

| | | | | | |
|--------------------------|------------------------|--|------------|---|----------|
| Load Plus Helper Springs | Drum Brake Models Only | | LP4 | 1 | \$165.00 |
|--------------------------|------------------------|--|------------|---|----------|

SUSPENSION KIT

| | | |
|-----------------------------|------------------|-----------|
| Medium - Nitro Gas | TOY008BKG | \$2839.00 |
| Medium - Foam Cell | TOY008BKF | \$3128.00 |
| Medium - Foam Cell Pro | TOY008BKP | \$3475.00 |
| Heavy - Nitro Gas | TOY008CKG | \$2867.00 |
| Heavy - Foam Cell | TOY008CKF | \$3156.00 |
| Heavy - Foam Cell Pro | TOY008CKP | \$3504.00 |
| Extra Heavy - Nitro Gas | TOY009DKG | \$2896.00 |
| Extra Heavy - Foam Cell | TOY009DKF | \$3186.00 |
| Extra Heavy - Foam Cell Pro | TOY009DKP | \$3533.00 |
| Super Heavy - Nitro Gas | TOY009EKG | \$2954.00 |
| Super Heavy - Foam Cell | TOY009EKF | \$3243.00 |
| Super Heavy - Foam Cell Pro | TOY009EKP | \$3591.00 |

SUSPENSION KIT CONTENTS

Shock Absorbers

Leaf Springs

U-Bolts

Polyurethane Spring Bushes

Toyota Landcruiser II

Prado 70, 73, 78 Series
1990 to 1996



Product Description

Part No.

Qty
Req

Retail
ea Inc GST

Please check vehicle date range (if shown) next to product description prior to ordering

SUSPENSION TO SUIT TOYOTA LANDCRUISER II - 1990-1996

FRONT SUSPENSION

SHOCK ABSORBER

| | | | | | |
|-------------------------|--|--|----------------|---|----------|
| Nitro Gas - Performance | | | 12696GR | 2 | \$160.00 |
| Foam Cell - Performance | | | 24696FE | 2 | \$232.00 |

COIL SPRINGS

| | Est. Lift | Additional Load | | | |
|--------|-----------|-----------------|----------------|---|----------|
| Medium | 50mm | 0 - 50kg | TOY048B | 1 | \$262.00 |
| Heavy | 50mm | 50 - 100kg | TOY048C | 1 | \$242.00 |

STEERING DAMPER

| | | | | | |
|-----------|--|--|-------------|---|----------|
| Foam Cell | | | 3524 | 1 | \$175.00 |
|-----------|--|--|-------------|---|----------|

REAR SUSPENSION

SHOCK ABSORBER

| | | | | | |
|-------------------------|--|--|----------------|---|----------|
| Nitro Gas - Performance | | | 12697GR | 2 | \$160.00 |
| Foam Cell - Performance | | | 24697FE | 2 | \$232.00 |

COIL SPRINGS

| | Est. Lift | Additional Load | | | |
|--------------|-----------|-----------------|----------------|---|----------|
| Medium - MWB | 50mm | 0 - 150kg | TOY049B | 1 | \$262.00 |
| Heavy - LWB | 50mm | 150 - 300kg | TOY049C | 1 | \$242.00 |

SUSPENSION KIT - Specify Front Coil Springs When Ordering

| | | |
|--------------------|------------------|-----------|
| Medium - Nitro Gas | TOY048BKG | \$1159.00 |
| Medium - Foam Cell | TOY048BKF | \$1449.00 |
| Heavy - Nitro Gas | TOY048CKG | \$1159.00 |
| Heavy - Foam Cell | TOY048CKF | \$1449.00 |

SUSPENSION KIT CONTENTS

Shock Absorbers

Coil Springs



1984 to 1989

SUSPENSION TO SUIT

Toyota Bundera

Product Description

Part No.

Qty
Req

Retail
ea Inc GST

Please check vehicle date range (if shown) next to product description prior to ordering

SUSPENSION TO SUIT TOYOTA BUNDERA - 1984-1989

FRONT SUSPENSION

SHOCK ABSORBER

| | | | | | |
|-------------------------|--|--|----------------|---|----------|
| Nitro Gas - Performance | | | 12091GR | 2 | \$160.00 |
| Foam Cell - Performance | | | 24091FE | 2 | \$232.00 |

COIL SPRINGS

| | Est. Lift | Additional Load | | | |
|--------|-----------|-----------------|----------------|---|----------|
| Medium | 50mm | 0 - 50kg | TOY018B | 1 | \$262.00 |

STEERING DAMPER

| | | | | | |
|-----------|--|--|-------------|---|----------|
| Foam Cell | | | 3524 | 1 | \$175.00 |
|-----------|--|--|-------------|---|----------|

REAR SUSPENSION

SHOCK ABSORBER

| | | | | | |
|-------------------------|-----------------|--|-----------------|---|----------|
| Nitro Gas - Performance | Left Hand Side | | 12639GRS | 1 | \$160.00 |
| Nitro Gas - Performance | Right Hand Side | | 12650GR | 1 | \$160.00 |
| Foam Cell - Performance | Left Hand Side | | 24639FES | 1 | \$232.00 |
| Foam Cell - Performance | Right Hand Side | | 24650FE | 1 | \$232.00 |

COIL SPRINGS

| | Est. Lift | Additional Load | | | |
|--------|-----------|-----------------|----------------|---|----------|
| Medium | 50mm | 0 - 200kg | TOY019B | 1 | \$262.00 |

SUSPENSION KIT

| | | |
|--------------------|------------------|-----------|
| Medium - Nitro Gas | TOY018BKG | \$1159.00 |
| Medium - Foam Cell | TOY018BKF | \$1449.00 |

SUSPENSION KIT CONTENTS

Shock Absorbers Coil Springs

Toyota Landcruiser

71 Series (Coil/Leaf)
1999+



Product Description

Part No.

Qty
Req

Retail
ea Inc GST

Please check vehicle date range (if shown) next to product description prior to ordering

SUSPENSION TO SUIT TOYOTA LANDCRUISER 71 SERIES - 1999+

FRONT SUSPENSION

SHOCK ABSORBER

| | | | | | |
|------------------------------|--|--|-----------------|---|----------|
| Nitro Gas - Performance | | | 12091GR | 2 | \$160.00 |
| Foam Cell - Performance | | | 24091FE | 2 | \$232.00 |
| Foam Cell Pro - Performance | | | 45091FE | 2 | \$319.00 |
| Foam Cell Pro - Professional | | | 45091FEP | 2 | \$319.00 |

COIL SPRINGS

| | Est. Lift | Additional Load | | | |
|--------|-----------|-----------------|----------------|---|----------|
| Light | 40mm | 0 - 50kg | TOY046A | 1 | \$262.00 |
| Medium | 50mm | 0 - 50kg | TOY046B | 1 | \$262.00 |
| Heavy | 50mm | 50 - 110kg | TOY046C | 1 | \$262.00 |

STEERING DAMPER

| | | | | | |
|-----------|--|--|-------------|---|----------|
| Foam Cell | | | 3525 | 1 | \$175.00 |
|-----------|--|--|-------------|---|----------|

CASTER CORRECTION

| | | | | | |
|---|--|--|---------------|---|----------|
| 2° Offset Bush Kit - Polyurethane | | | 1144SK | 1 | \$160.00 |
| Adjustable Offset STD, 2.5, 3.5 Degree - Polyurethane | | | 1144 | 1 | \$160.00 |
| 2° Offset Bush Kit - Rubber | | | 1144RK | 1 | \$160.00 |

SWAY BAR LINK

| | | | | | |
|------------------------|--|--|-----------------|---|---------|
| Extended Sway Bar Link | | | SBEXT001 | 2 | \$30.00 |
|------------------------|--|--|-----------------|---|---------|

COIL SPACER

| | | | | | |
|-------------------|--|--|----------------|---|---------|
| Polyurethane 30mm | | | LC70F30 | 2 | \$44.00 |
|-------------------|--|--|----------------|---|---------|

REAR SUSPENSION

SHOCK ABSORBER

| | | | | | |
|------------------------------|--|--|-----------------|---|----------|
| Nitro Gas - Comfort | | | 12081GRC | 2 | \$160.00 |
| Nitro Gas - Performance | | | 12081GR | 2 | \$160.00 |
| Foam Cell - Comfort | | | 24081FEC | 2 | \$232.00 |
| Foam Cell - Performance | | | 24081FE | 2 | \$232.00 |
| Foam Cell - Professional | | | 24081FEP | 2 | \$232.00 |
| Foam Cell Pro - Comfort | | | 45081FEC | 2 | \$319.00 |
| Foam Cell Pro - Performance | | | 45081FE | 2 | \$319.00 |
| Foam Cell Pro - Professional | | | 45081FEP | 2 | \$319.00 |

LEAF SPRINGS

| | Est. Lift | Additional Load | | | |
|--------|-----------|-----------------|-------------------|---|----------|
| Light | 50mm | 0 - 150kg | TOY007AD/S | 2 | \$392.00 |
| Medium | 50mm | 0 - 250kg | TOY007BD/S | 2 | \$392.00 |
| Heavy | 50mm | 250kg - GVM | TOY007CD/S | 2 | \$421.00 |

U-BOLTS

| | | | | | |
|------------|--|--|---------------|---|---------|
| U-Bolt Kit | | | 415UBK | 2 | \$44.00 |
|------------|--|--|---------------|---|---------|

POLYURETHANE SPRING BUSHES

| | | | | | |
|----------|--|--|---------------|---|---------|
| Bush Kit | | | 1185UK | 1 | \$88.00 |
|----------|--|--|---------------|---|---------|

GREASABLE SHACKLES AND PINS

| | | | | | |
|-------------------|--|------------|---------------|---|---------|
| Greasable Shackle | | | 1141-1 | 2 | \$74.00 |
| Greasable Shackle | | Extra long | 1141 | 2 | \$74.00 |
| Greasable Pin | | | 1142 | 2 | \$44.00 |

SUSPENSION KIT - Specify Front Coil Springs When Ordering

| | | | | | |
|------------------------|--|--|------------------|--|-----------|
| Light - Nitro Gas | | | TOY058AKG | | \$1854.00 |
| Light - Foam Cell | | | TOY058AKF | | \$2144.00 |
| Light - Foam Cell Pro | | | TOY058AKP | | \$2491.00 |
| Medium - Nitro Gas | | | TOY058BKG | | \$1854.00 |
| Medium - Foam Cell | | | TOY058BKF | | \$2144.00 |
| Medium - Foam Cell Pro | | | TOY058BKP | | \$2491.00 |
| Heavy - Nitro Gas | | | TOY058CKG | | \$1912.00 |
| Heavy - Foam Cell | | | TOY058CKF | | \$2201.00 |
| Heavy - Foam Cell Pro | | | TOY058CKP | | \$2548.00 |

SUSPENSION KIT CONTENTS

| | | | |
|-----------------|--------------|---------|----------------------------|
| Shock Absorbers | Leaf Springs | U-Bolts | Polyurethane Spring Bushes |
| Leaf Springs | | | |



70, 73, 74 Series (Leaf/Leaf)
1984 to 1988

Toyota Landcruiser

Product Description

Part No.

Qty Req

Retail ea Inc GST

Please check vehicle date range (if shown) next to product description prior to ordering

SUSPENSION TO SUIT TOYOTA LANDCRUISER 70, 73, 74 SERIES - 1984-1988

FRONT SUSPENSION

SHOCK ABSORBER

| | | | | | |
|-----------------------------|--|--|-----------------|---|----------|
| Nitro Gas - Comfort | | | 12637GRC | 2 | \$160.00 |
| Nitro Gas - Performance | | | 12637GR | 2 | \$160.00 |
| Foam Cell - Comfort | | | 24637FEC | 2 | \$232.00 |
| Foam Cell - Performance | | | 24637FE | 2 | \$232.00 |
| Foam Cell Pro - Comfort | | | 45637FEC | 2 | \$319.00 |
| Foam Cell Pro - Performance | | | 45637FE | 2 | \$319.00 |

LEAF SPRINGS

| | Est. Lift | Additional Load | | | |
|--------|-----------|-----------------|----------------|---|----------|
| Medium | 50mm | 0 - 100kg | TOY008B | 2 | \$392.00 |

STEERING DAMPER

| | | | | | |
|-----------|--|--|-------------|---|----------|
| Foam Cell | | | 3524 | 1 | \$175.00 |
|-----------|--|--|-------------|---|----------|

U-BOLTS

| | | | | | |
|------------|--|--|---------------|---|---------|
| U-Bolt Kit | | | 436UBK | 2 | \$44.00 |
|------------|--|--|---------------|---|---------|

POLYURETHANE SPRING BUSHES

| | | | | | |
|----------|--|--|--------------|---|---------|
| Bush Kit | | | 719UK | 1 | \$74.00 |
|----------|--|--|--------------|---|---------|

GREASABLE SHACKLES AND PINS

| | | | | | |
|-------------------|-----------------|--|--------------|---|---------|
| Greasable Shackle | Left Hand Side | | 348LH | 1 | \$74.00 |
| Greasable Shackle | Right Hand Side | | 348RH | 1 | \$74.00 |
| Greasable Pin | | | 351 | 2 | \$44.00 |

REAR SUSPENSION

SHOCK ABSORBER

| | | | | | |
|------------------------------|--|--|-----------------|---|----------|
| Nitro Gas - Comfort | | | 12650GRC | 2 | \$160.00 |
| Nitro Gas - Performance | | | 12650GR | 2 | \$160.00 |
| Foam Cell - Comfort | | | 24650FEC | 2 | \$232.00 |
| Foam Cell - Performance | | | 24650FE | 2 | \$232.00 |
| Foam Cell - Professional | | | 24650FEP | 2 | \$232.00 |
| Foam Cell Pro - Comfort | | | 45650FEC | 2 | \$319.00 |
| Foam Cell Pro - Performance | | | 45650FE | 2 | \$319.00 |
| Foam Cell Pro - Professional | | | 45650FEP | 2 | \$319.00 |

LEAF SPRINGS

| | Est. Lift | Additional Load | | | |
|--------|-----------|-----------------|-------------------|---|----------|
| Light | 50mm | 0 - 200kg | TOY007AN/S | 2 | \$392.00 |
| Medium | 50mm | 0 - 200kg | TOY007BN/S | 2 | \$392.00 |

U-BOLTS

| | | | | | |
|------------|--|--|---------------|---|---------|
| U-Bolt Kit | | | 415UBK | 2 | \$44.00 |
|------------|--|--|---------------|---|---------|

POLYURETHANE SPRING BUSHES

| | | | | | |
|----------|--|--|--------------|---|---------|
| Bush Kit | | | 719UK | 1 | \$74.00 |
|----------|--|--|--------------|---|---------|

GREASABLE SHACKLES AND PINS

| | | | | | |
|-------------------|-----------------|--|--------------|---|---------|
| Greasable Shackle | Left Hand Side | | 353LH | 1 | \$74.00 |
| Greasable Shackle | Right Hand Side | | 353RH | 1 | \$74.00 |
| Greasable Pin | | | 354 | 2 | \$44.00 |

HELPER SPRINGS

| | | | | | |
|--------------------------|--|--|------------|---|----------|
| Load Plus Helper Springs | | | LP4 | 1 | \$165.00 |
|--------------------------|--|--|------------|---|----------|

SUSPENSION KIT

| | | | |
|------------------------|--|------------------|-----------|
| Light - Nitro Gas | | TOY016AKG | \$2520.00 |
| Light - Foam Cell | | TOY016AKF | \$2809.00 |
| Light - Foam Cell Pro | | TOY016AKP | \$3156.00 |
| Medium - Nitro Gas | | TOY016BKG | \$2520.00 |
| Medium - Foam Cell | | TOY016BKF | \$2809.00 |
| Medium - Foam Cell Pro | | TOY016BKP | \$3156.00 |

SUSPENSION KIT CONTENTS

Shock Absorbers

Leaf Springs

U-Bolts

Polyurethane Spring Bushes

Toyota Landcruiser

60 Series
11/1980 to 11/1989



Product Description

Part No.

Qty
Req

Retail
ea Inc GST

Please check vehicle date range (if shown) next to product description prior to ordering

ACCESSORIES TO SUIT TOYOTA LANDCRUISER 60 SERIES - 11/1980-11/1989

LOCKSAFE DRAWER SYSTEMS

| | | | |
|------------------------|---------|--|-----------|
| Twin Drawers - 1000mm | ITD1000 | | \$1355.00 |
| Single Drawer - 1000mm | ISD1000 | | \$820.00 |
| Wing Kit - 1000mm | ITDW013 | | \$283.00 |

STEEL ROOF RACKS

| | | | |
|--|------------|--|----------|
| Cage Style - 1.4m x 1.25m | IRRCAGE14 | | \$812.00 |
| Cage Style - 1.8m x 1.25m | IRRCAGE18 | | \$852.00 |
| Cage Style - 2.2m x 1.25m | IRRCAGE22 | | \$885.00 |
| Rooftop Tent Compatible - 1.8m x 1.25m | IRRTENT18 | | \$812.00 |
| Rooftop Tent Compatible - 2.2m x 1.25m | IRRTENT22 | | \$852.00 |
| Trade Style - 1.8m x 1.25m (Open end) | IRRTRADE18 | | \$812.00 |
| Trade Style - 2.2m x 1.25m (Open end) | IRRTRADE22 | | \$846.00 |

ALLOY ROOF RACKS

| | | | |
|---------------------------------------|------------------|--|-----------|
| Cage Style - 1.4m x 1.25m | IRRCAGE14-ALLOY | | \$1028.00 |
| Cage Style - 1.8m x 1.25m | IRRCAGE18-ALLOY | | \$1201.00 |
| Cage Style - 2.2m x 1.25m | IRRCAGE22-ALLOY | | \$1267.00 |
| Trade Style - 1.4m x 1.25m (Open end) | IRROPEN14-ALLOY | | \$1015.00 |
| Trade Style - 1.8m x 1.25m (Open end) | IRRTRADE18-ALLOY | | \$1183.00 |
| Trade Style - 2.2m x 1.25m (Open end) | IRRTRADE22-ALLOY | | \$1235.00 |
| Flat Rack - 1.8m x 1.25m | IRRFLAT18-ALLOY | | \$1167.00 |

STEEL AND ALLOY ROOF RACK - MOUNT KITS

| | | | |
|------------------------------------|------------|--|----------|
| Gutter Mount Feet - 125mm (8 Feet) | IRRFEET125 | | \$207.00 |
|------------------------------------|------------|--|----------|

BREATHER KIT

| | | | |
|---|----------|--|----------|
| Universal Twin Manifold Filtered Breather Kit | IDIFFBRE | | \$115.00 |
|---|----------|--|----------|

SUSPENSION TO SUIT TOYOTA LANDCRUISER 60 SERIES - 11/1980-11/1989

FRONT SUSPENSION

SHOCK ABSORBER

| | | | |
|-----------------------------|----------|---|----------|
| Nitro Gas - Comfort | 12637GRC | 2 | \$160.00 |
| Nitro Gas - Performance | 12637GR | 2 | \$160.00 |
| Foam Cell - Comfort | 24637FEC | 2 | \$232.00 |
| Foam Cell - Performance | 24637FE | 2 | \$232.00 |
| Foam Cell Pro - Comfort | 45637FEC | 2 | \$319.00 |
| Foam Cell Pro - Performance | 45637FE | 2 | \$319.00 |

LEAF SPRINGS

| | Est. Lift | Additional Load | | | |
|-------------------|-----------|-----------------|---------|---|----------|
| Petrol | 50mm | 0 - 80kg | TOY006B | 2 | \$392.00 |
| Diesel or Bullbar | 50mm | 50 - 100kg | TOY006C | 2 | \$421.00 |
| Turbo Diesel | 50mm | 50 - 100kg | TOY006D | 2 | \$421.00 |

STEERING DAMPER

| | | | |
|-----------|------|---|----------|
| Foam Cell | 3524 | 1 | \$175.00 |
|-----------|------|---|----------|

U-BOLTS

| | | | |
|------------|--------|---|---------|
| U-Bolt Kit | 436UBK | 2 | \$44.00 |
|------------|--------|---|---------|

POLYURETHANE SPRING BUSHES

| | | | |
|----------|-------|---|---------|
| Bush Kit | 719UK | 1 | \$74.00 |
|----------|-------|---|---------|

GREASABLE SHACKLES AND PINS

| | | | | |
|-------------------|-----------------|-------|---|---------|
| Greasable Shackle | Left Hand Side | 348LH | 1 | \$74.00 |
| Greasable Shackle | Right Hand Side | 348RH | 1 | \$74.00 |
| Greasable Pin | | 351 | 2 | \$44.00 |



60 Series
1986+

Toyota Landcruiser

| Product Description | Part No. | Qty Req | Retail ea Inc GST |
|--|-----------------|-----------------|-----------------------|
| <i>Please check vehicle date range (if shown) next to product description prior to ordering</i> | | | |
| REAR SUSPENSION | | | |
| SHOCK ABSORBER | | | |
| Nitro Gas - Comfort | 12650GRC | 2 | \$160.00 |
| Nitro Gas - Performance | 12650GR | 2 | \$160.00 |
| Foam Cell - Comfort | 24650FEC | 2 | \$232.00 |
| Foam Cell - Performance | 24650FE | 2 | \$232.00 |
| Foam Cell - Professional | 24650FEP | 2 | \$232.00 |
| Foam Cell Pro - Comfort | 45650FEC | 2 | \$319.00 |
| Foam Cell Pro - Performance | 45650FE | 2 | \$319.00 |
| Foam Cell Pro - Professional | 45650FEP | 2 | \$319.00 |
| LEAF SPRINGS | | | |
| | Est. Lift | Additional Load | |
| Light - Drivers Side | 50mm | 0 - 200kg | TOY007AD/S 1 \$392.00 |
| Light - Near Side | 50mm | 0 - 200kg | TOY007AN/S 1 \$392.00 |
| Medium - Drivers Side | 50mm | 0 - 200kg | TOY007BD/S 1 \$392.00 |
| Medium - Near Side | 50mm | 0 - 200kg | TOY007BN/S 1 \$392.00 |
| Heavy - Drivers Side | 50mm | 200kg - GVM | TOY007CD/S 1 \$421.00 |
| Heavy - Near Side | 50mm | 200kg - GVM | TOY007CN/S 1 \$421.00 |
| • Side hinge barn door models may require (D/S-D/S) or (N/S-N/S) rear spring configuration to maintain level | | | |
| U-BOLTS | | | |
| U-Bolt Kit | 415UBK | 2 | \$44.00 |
| POLYURETHANE SPRING BUSHES | | | |
| Bush Kit | 719UK | 1 | \$74.00 |
| GREASABLE SHACKLES AND PINS | | | |
| Greasable Shackle | Left Hand Side | 353LH | 1 \$74.00 |
| Greasable Shackle | Right Hand Side | 353RH | 1 \$74.00 |
| Greasable Pin | | 351 | 2 \$44.00 |
| HELPER SPRINGS | | | |
| Load Plus Helper Springs | LP4 | 1 | \$165.00 |

SUSPENSION KIT

| | | | |
|------------------------|--------|------------|-----------|
| Light - Nitro Gas | Petrol | TOY006AKG3 | \$2520.00 |
| Light - Foam Cell | Petrol | TOY006AKF3 | \$2809.00 |
| Light - Foam Cell Pro | Petrol | TOY006AKP3 | \$3156.00 |
| Light - Nitro Gas | Diesel | TOY006AKG2 | \$2577.00 |
| Light - Foam Cell | Diesel | TOY006AKF2 | \$2867.00 |
| Light - Foam Cell Pro | Diesel | TOY006AKP2 | \$3215.00 |
| Medium - Nitro Gas | Petrol | TOY006BKG2 | \$2520.00 |
| Medium - Foam Cell | Petrol | TOY006BKF2 | \$2809.00 |
| Medium - Foam Cell Pro | Petrol | TOY006BKP2 | \$3156.00 |
| Medium - Nitro Gas | Diesel | TOY006CKG2 | \$2577.00 |
| Medium - Foam Cell | Diesel | TOY006CKF2 | \$2867.00 |
| Medium - Foam Cell Pro | Diesel | TOY006CKP2 | \$3215.00 |
| Heavy - Nitro Gas | Petrol | TOY007BKG2 | \$2577.00 |
| Heavy - Foam Cell | Petrol | TOY007BKF2 | \$2867.00 |
| Heavy - Foam Cell Pro | Petrol | TOY007BKP2 | \$3215.00 |
| Heavy - Nitro Gas | Diesel | TOY007CKG2 | \$2636.00 |
| Heavy - Foam Cell | Diesel | TOY007CKF2 | \$2925.00 |
| Heavy - Foam Cell Pro | Diesel | TOY007CKP2 | \$3272.00 |

SUSPENSION KIT CONTENTS

| | | | |
|-----------------|--------------|---------|----------------------------|
| Shock Absorbers | Leaf Springs | U-Bolts | Polyurethane Spring Bushes |
|-----------------|--------------|---------|----------------------------|

Toyota Landcruiser

60 Series
Pre 1986



Product Description

Part No.

Qty
Req

Retail
ea Inc GST

Please check vehicle date range (if shown) next to product description prior to ordering

SUSPENSION TO SUIT TOYOTA LANDCRUISER 60 SERIES - PRE 1986

FRONT SUSPENSION

SHOCK ABSORBER

| | | | | | |
|-----------------------------|--|--|-----------------|---|----------|
| Nitro Gas - Comfort | | | 12637GRC | 2 | \$160.00 |
| Nitro Gas - Performance | | | 12637GR | 2 | \$160.00 |
| Foam Cell - Comfort | | | 24637FEC | 2 | \$232.00 |
| Foam Cell - Performance | | | 24637FE | 2 | \$232.00 |
| Foam Cell Pro - Comfort | | | 45637FEC | 2 | \$319.00 |
| Foam Cell Pro - Performance | | | 45637FE | 2 | \$319.00 |

LEAF SPRINGS

| | Est. Lift | Additional Load | | | |
|-------------------|-----------|-----------------|----------------|---|----------|
| Petrol | 50mm | 0 - 80kg | TOY006B | 2 | \$392.00 |
| Diesel or Bullbar | 50mm | 50 - 100kg | TOY006C | 2 | \$421.00 |
| Turbo Diesel | 50mm | 50 - 100kg | TOY006D | 2 | \$421.00 |

STEERING DAMPER

| | | | | | |
|-----------|--|--|-------------|---|----------|
| Foam Cell | | | 3524 | 1 | \$175.00 |
|-----------|--|--|-------------|---|----------|

U-BOLTS

| | | | | | |
|------------|--|--|---------------|---|---------|
| U-Bolt Kit | | | 436UBK | 2 | \$44.00 |
|------------|--|--|---------------|---|---------|

POLYURETHANE SPRING BUSHES

| | | | | | |
|----------|--|--|--------------|---|---------|
| Bush Kit | | | 719UK | 1 | \$74.00 |
|----------|--|--|--------------|---|---------|

GREASABLE SHACKLES AND PINS

| | | | | | |
|-------------------|-----------------|--|--------------|---|---------|
| Greasable Shackle | Left Hand Side | | 348LH | 1 | \$74.00 |
| Greasable Shackle | Right Hand Side | | 348RH | 1 | \$74.00 |
| Greasable Pin | | | 351 | 2 | \$44.00 |

REAR SUSPENSION

SHOCK ABSORBER

| | | | | | |
|------------------------------|--|--|-----------------|---|----------|
| Nitro Gas - Comfort | | | 12636GRC | 2 | \$160.00 |
| Nitro Gas - Performance | | | 12636GR | 2 | \$160.00 |
| Nitro Gas - Professional | | | 12636GRP | 2 | \$160.00 |
| Foam Cell - Comfort | | | 24636FEC | 2 | \$232.00 |
| Foam Cell - Performance | | | 24636FE | 2 | \$232.00 |
| Foam Cell - Professional | | | 24636FEP | 2 | \$232.00 |
| Foam Cell Pro - Comfort | | | 45636FEC | 2 | \$319.00 |
| Foam Cell Pro - Performance | | | 45636FE | 2 | \$319.00 |
| Foam Cell Pro - Professional | | | 45636FEP | 2 | \$319.00 |

LEAF SPRINGS

| | Est. Lift | Additional Load | | | |
|-----------------------|-----------|-----------------|-------------------|---|----------|
| Light - Drivers Side | 50mm | 0 - 200kg | TOY007AD/S | 1 | \$392.00 |
| Light - Near Side | 50mm | 0 - 200kg | TOY007AN/S | 1 | \$392.00 |
| Medium - Drivers Side | 50mm | 0 - 200kg | TOY007BD/S | 1 | \$392.00 |
| Medium - Near Side | 50mm | 0 - 200kg | TOY007BN/S | 1 | \$392.00 |
| Heavy - Drivers Side | 50mm | 200kg - GVM | TOY007CD/S | 1 | \$421.00 |
| Heavy - Near Side | 50mm | 200kg - GVM | TOY007CN/S | 1 | \$421.00 |

• Side hinge barn door models may require (D/S-D/S) or (N/S-N/S) rear spring configuration to maintain level

U-BOLTS

| | | | | | |
|------------|--|--|---------------|---|---------|
| U-Bolt Kit | | | 415UBK | 2 | \$44.00 |
|------------|--|--|---------------|---|---------|

POLYURETHANE SPRING BUSHES

| | | | | | |
|----------|--|--|--------------|---|---------|
| Bush Kit | | | 719UK | 1 | \$74.00 |
|----------|--|--|--------------|---|---------|

GREASABLE SHACKLES AND PINS

| | | | | | |
|-------------------|-----------------|--|--------------|---|---------|
| Greasable Shackle | Left Hand Side | | 353LH | 1 | \$74.00 |
| Greasable Shackle | Right Hand Side | | 353RH | 1 | \$74.00 |
| Greasable Pin | | | 351 | 2 | \$44.00 |

HELPER SPRINGS

| | | | | | |
|--------------------------|--|--|------------|---|----------|
| Load Plus Helper Springs | | | LP4 | 1 | \$165.00 |
|--------------------------|--|--|------------|---|----------|



60 Series
Pre 1986

Toyota Landcruiser

Product Description

Part No.

Qty
Req

Retail
ea Inc GST

Please check vehicle date range (if shown) next to product description prior to ordering

SUSPENSION KIT

| | | | |
|------------------------|--------|------------|-----------|
| Light - Nitro Gas | Petrol | TOY006AKG | \$2520.00 |
| Light - Nitro Gas | Diesel | TOY006AKG1 | \$2577.00 |
| Light - Foam Cell | Petrol | TOY006AKF | \$2809.00 |
| Light - Foam Cell | Diesel | TOY006AKF1 | \$2867.00 |
| Light - Foam Cell Pro | Petrol | TOY006AKP | \$3156.00 |
| Light - Foam Cell Pro | Diesel | TOY006AKP1 | \$3215.00 |
| Medium - Nitro Gas | Petrol | TOY006BKG1 | \$2520.00 |
| Medium - Nitro Gas | Diesel | TOY006CKG1 | \$2577.00 |
| Medium - Foam Cell | Petrol | TOY006BKF1 | \$2809.00 |
| Medium - Foam Cell | Diesel | TOY006CKF1 | \$2867.00 |
| Medium - Foam Cell Pro | Petrol | TOY006BKP1 | \$3156.00 |
| Medium - Foam Cell Pro | Diesel | TOY006CKP1 | \$3215.00 |
| Heavy - Nitro Gas | Petrol | TOY007BKG1 | \$2577.00 |
| Heavy - Nitro Gas | Diesel | TOY007CKG1 | \$2636.00 |
| Heavy - Foam Cell | Petrol | TOY007BKF1 | \$2867.00 |
| Heavy - Foam Cell | Diesel | TOY007CKF1 | \$2925.00 |
| Heavy - Foam Cell Pro | Petrol | TOY007BKP1 | \$3215.00 |
| Heavy - Foam Cell Pro | Diesel | TOY007CKP1 | \$3272.00 |

SUSPENSION KIT CONTENTS

Shock Absorbers

Leaf Springs

U-Bolts

Polyurethane Spring Bushes

Toyota Landcruiser

45, 47 Series
8/1980 to 1985



Product Description

Part No.

Qty
Req

Retail
ea Inc GST

Please check vehicle date range (if shown) next to product description prior to ordering

SUSPENSION TO SUIT TOYOTA LANDCRUISER 45, 47 SERIES - 8/1980-1985

FRONT SUSPENSION

SHOCK ABSORBER

| | | | | | |
|-----------------------------|--|--|-----------------|---|----------|
| Nitro Gas - Comfort | | | 12635GRC | 2 | \$160.00 |
| Nitro Gas - Performance | | | 12635GR | 2 | \$160.00 |
| Foam Cell - Comfort | | | 24635FEC | 2 | \$216.00 |
| Foam Cell - Performance | | | 24635FE | 2 | \$232.00 |
| Foam Cell Pro - Performance | | | 45635FE | 2 | \$319.00 |

LEAF SPRINGS

| | Est. Lift | Additional Load | | | |
|--------|-----------|-----------------|----------------|---|----------|
| Medium | 50mm | 0 - 80kg | TOY004B | 2 | \$392.00 |
| Heavy | 50mm | 80 - 120kg | TOY004C | 2 | \$392.00 |

STEERING DAMPER

| | | | | | |
|-----------|--|--|-------------|---|----------|
| Foam Cell | | | 3523 | 1 | \$175.00 |
|-----------|--|--|-------------|---|----------|

U-BOLTS

| | | | | | |
|------------|--|--------------|---------------|---|---------|
| U-Bolt Kit | | Drivers Side | 449UBK | 1 | \$44.00 |
| U-Bolt Kit | | Near Side | 415UBK | 1 | \$44.00 |

POLYURETHANE SPRING BUSHES

| | | | | | |
|----------|--|--|--------------|---|---------|
| Bush Kit | | | 719UK | 1 | \$74.00 |
|----------|--|--|--------------|---|---------|

GREASABLE SHACKLES AND PINS

| | | | | | |
|-------------------|--|--|--------------|---|---------|
| Greasable Shackle | | | 348LH | 1 | \$74.00 |
| Greasable Shackle | | | 348RH | 1 | \$74.00 |
| Greasable Pin | | | 351 | 2 | \$44.00 |

REAR SUSPENSION

SHOCK ABSORBER

| | | | | | |
|------------------------------|--|--|-----------------|---|----------|
| Nitro Gas - Comfort | | | 12636GRC | 2 | \$160.00 |
| Nitro Gas - Performance | | | 12636GR | 2 | \$160.00 |
| Nitro Gas - Professional | | | 12636GRP | 2 | \$160.00 |
| Foam Cell - Comfort | | | 24636FEC | 2 | \$232.00 |
| Foam Cell - Performance | | | 24636FE | 2 | \$232.00 |
| Foam Cell - Professional | | | 24636FEP | 2 | \$232.00 |
| Foam Cell Pro - Comfort | | | 45636FEC | 2 | \$319.00 |
| Foam Cell Pro - Performance | | | 45636FE | 2 | \$319.00 |
| Foam Cell Pro - Professional | | | 45636FEP | 2 | \$319.00 |

LEAF SPRINGS

| | Est. Lift | Additional Load | | | |
|--------|-----------|-----------------|----------------|---|----------|
| Medium | 50mm | 0 - 400kg | TOY005C | 2 | \$638.00 |

U-BOLTS

| | | | | | |
|------------|--|--|---------------|---|---------|
| U-Bolt Kit | | | 415UBK | 2 | \$44.00 |
|------------|--|--|---------------|---|---------|

POLYURETHANE SPRING BUSHES

| | | | | | |
|----------|--|--|--------------|---|---------|
| Bush Kit | | | 719UK | 1 | \$74.00 |
|----------|--|--|--------------|---|---------|

GREASABLE SHACKLES AND PINS

| | | | | | |
|-------------------|--|-----------------|--------------|---|---------|
| Greasable Shackle | | Left Hand Side | 353LH | 1 | \$74.00 |
| Greasable Shackle | | Right Hand Side | 353RH | 1 | \$74.00 |
| Greasable Pin | | | 351 | 2 | \$44.00 |

HELPER SPRINGS

| | | | | | |
|--------------------------|--|--|------------|---|----------|
| Load Plus Helper Springs | | | LP4 | 1 | \$165.00 |
|--------------------------|--|--|------------|---|----------|

SUSPENSION KIT

| | | | | | |
|-----------------------|--|--|------------------|--|-----------|
| Heavy - Nitro Gas | | | TOY005BKG | | \$3012.00 |
| Heavy - Foam Cell | | | TOY005BKF | | \$3302.00 |
| Heavy - Foam Cell Pro | | | TOY005BKP | | \$3649.00 |

SUSPENSION KIT CONTENTS

Shock Absorbers

Leaf Springs

U-Bolts

Polyurethane Spring Bushes



45 Series
1960 to 1980

Toyota Landcruiser

Product Description

Part No.

Qty
ReqRetail
ea Inc GST

Please check vehicle date range (if shown) next to product description prior to ordering

SUSPENSION TO SUIT TOYOTA LANDCRUISER 45 SERIES - 1960-1980

FRONT SUSPENSION

SHOCK ABSORBER

| | | | | | |
|-----------------------------|--|--|-----------------|---|----------|
| Nitro Gas - Comfort | | | 12635GRC | 2 | \$160.00 |
| Nitro Gas - Performance | | | 12635GR | 2 | \$160.00 |
| Foam Cell - Comfort | | | 24635FEC | 2 | \$216.00 |
| Foam Cell - Performance | | | 24635FE | 2 | \$232.00 |
| Foam Cell Pro - Performance | | | 45635FE | 2 | \$319.00 |

LEAF SPRINGS

| | Est. Lift | Additional Load | | | |
|--------|-----------|-----------------|----------------|---|----------|
| Medium | 50mm | 0 - 100kg | TOY001B | 2 | \$392.00 |

STEERING DAMPER

| | | | | | |
|-----------|--|--|-------------|---|----------|
| Foam Cell | | | 3523 | 1 | \$175.00 |
|-----------|--|--|-------------|---|----------|

U-BOLTS

| | | | | | |
|------------|--|--|---------------|---|---------|
| U-Bolt Kit | | | 415UBK | 2 | \$44.00 |
|------------|--|--|---------------|---|---------|

POLYURETHANE SPRING BUSHES

| | | | | | |
|----------|--|--|--------------|---|---------|
| Bush Kit | | | 713UK | 1 | \$74.00 |
|----------|--|--|--------------|---|---------|

GREASABLE SHACKLES AND PINS

| | | | | | |
|-------------------|--|-----------------|--------------|---|---------|
| Greasable Shackle | | Left Hand Side | 343LH | 1 | \$74.00 |
| Greasable Shackle | | Right Hand Side | 343RH | 1 | \$74.00 |
| Greasable Pin | | | 346 | 2 | \$44.00 |

REAR SUSPENSION

SHOCK ABSORBER

| | | | | | |
|------------------------------|--|--|-----------------|---|----------|
| Nitro Gas - Comfort | | | 12636GRC | 2 | \$160.00 |
| Nitro Gas - Performance | | | 12636GR | 2 | \$160.00 |
| Nitro Gas - Professional | | | 12636GRP | 2 | \$160.00 |
| Foam Cell - Comfort | | | 24636FEC | 2 | \$232.00 |
| Foam Cell - Performance | | | 24636FE | 2 | \$232.00 |
| Foam Cell - Professional | | | 24636FEP | 2 | \$232.00 |
| Foam Cell Pro - Comfort | | | 45636FEC | 2 | \$319.00 |
| Foam Cell Pro - Performance | | | 45636FE | 2 | \$319.00 |
| Foam Cell Pro - Professional | | | 45636FEP | 2 | \$319.00 |

LEAF SPRINGS

| | Est. Lift | Additional Load | | | |
|-------|-----------|-----------------|----------------|---|----------|
| Heavy | 50mm | 0 - 400kg | TOY003C | 2 | \$638.00 |

U-BOLTS

| | | | | | |
|------------|--|--|---------------|---|---------|
| U-Bolt Kit | | | 415UBK | 2 | \$44.00 |
|------------|--|--|---------------|---|---------|

POLYURETHANE SPRING BUSHES

| | | | | | |
|----------|--|--|--------------|---|---------|
| Bush Kit | | | 714UK | 1 | \$74.00 |
|----------|--|--|--------------|---|---------|

GREASABLE SHACKLES AND PINS

| | | | | | |
|-------------------|--|-----------------|------------|---|---------|
| Greasable Shackle | | Left Hand Side | 344 | 1 | \$74.00 |
| Greasable Shackle | | Right Hand Side | 345 | 1 | \$74.00 |
| Greasable Pin | | | 347 | 2 | \$30.00 |

HELPER SPRINGS

| | | | | | |
|--------------------------|--|--|------------|---|----------|
| Load Plus Helper Springs | | | LP4 | 1 | \$165.00 |
|--------------------------|--|--|------------|---|----------|

SUSPENSION KIT

| | | | | | |
|-----------------------|--|--|------------------|--|-----------|
| Heavy - Nitro Gas | | | TOY003BKG | | \$3012.00 |
| Heavy - Foam Cell | | | TOY003BKF | | \$3302.00 |
| Heavy - Foam Cell Pro | | | TOY003BKP | | \$3649.00 |

SUSPENSION KIT CONTENTS

Shock Absorbers

Leaf Springs

U-Bolts

Polyurethane Spring Bushes

Toyota Landcruiser

40, 42, 46 Series
1980 to 1984



Product Description

Part No.

Qty
Req

Retail
ea Inc GST

Please check vehicle date range (if shown) next to product description prior to ordering

SUSPENSION TO SUIT TOYOTA LANDCRUISER 40, 42, 46 SERIES - 1980-1984

FRONT SUSPENSION

SHOCK ABSORBER

| | | | | | |
|-----------------------------|--|--|-----------------|---|----------|
| Nitro Gas - Comfort | | | 12635GRC | 2 | \$160.00 |
| Nitro Gas - Performance | | | 12635GR | 2 | \$160.00 |
| Foam Cell - Comfort | | | 24635FEC | 2 | \$216.00 |
| Foam Cell - Performance | | | 24635FE | 2 | \$232.00 |
| Foam Cell Pro - Performance | | | 45635FE | 2 | \$319.00 |

LEAF SPRINGS

| | Est. Lift | Additional Load | | | |
|--------|-----------|-----------------|----------------|---|----------|
| Medium | 50mm | 0 - 80kg | TOY004B | 2 | \$392.00 |
| Heavy | 50mm | 80 - 120kg | TOY004C | 2 | \$392.00 |

STEERING DAMPER

| | | | | | |
|-----------|--|--|-------------|---|----------|
| Foam Cell | | | 3523 | 1 | \$175.00 |
|-----------|--|--|-------------|---|----------|

U-BOLTS

| | | | | | |
|------------|--|--|---------------|---|---------|
| U-Bolt Kit | | | 415UBK | 2 | \$44.00 |
|------------|--|--|---------------|---|---------|

POLYURETHANE SPRING BUSHES

| | | | | | |
|----------|--|--|--------------|---|---------|
| Bush Kit | | | 719UK | 1 | \$74.00 |
|----------|--|--|--------------|---|---------|

GREASABLE SHACKLES AND PINS

| | | | | | |
|-------------------|-----------------|--|--------------|---|---------|
| Greasable Shackle | Left Hand Side | | 348LH | 1 | \$74.00 |
| Greasable Shackle | Right Hand Side | | 348RH | 1 | \$74.00 |
| Greasable Pin | | | 351 | 2 | \$44.00 |

REAR SUSPENSION

SHOCK ABSORBER

| | | | | | |
|------------------------------|--|--|-----------------|---|----------|
| Nitro Gas - Comfort | | | 12636GRC | 2 | \$160.00 |
| Nitro Gas - Performance | | | 12636GR | 2 | \$160.00 |
| Nitro Gas - Professional | | | 12636GRP | 2 | \$160.00 |
| Foam Cell - Comfort | | | 24636FEC | 2 | \$232.00 |
| Foam Cell - Performance | | | 24636FE | 2 | \$232.00 |
| Foam Cell - Professional | | | 24636FEP | 2 | \$232.00 |
| Foam Cell Pro - Comfort | | | 45636FEC | 2 | \$319.00 |
| Foam Cell Pro - Performance | | | 45636FE | 2 | \$319.00 |
| Foam Cell Pro - Professional | | | 45636FEP | 2 | \$319.00 |

LEAF SPRINGS

| | Est. Lift | Additional Load | | | |
|-------|-----------|-----------------|----------------|---|----------|
| Heavy | 50mm | 0 - 200kg | TOY034B | 2 | \$392.00 |

U-BOLTS

| | | | | | |
|------------|--|--|---------------|---|---------|
| U-Bolt Kit | | | 415UBK | 2 | \$44.00 |
|------------|--|--|---------------|---|---------|

POLYURETHANE SPRING BUSHES

| | | | | | |
|----------|--|--|--------------|---|---------|
| Bush Kit | | | 719UK | 1 | \$74.00 |
|----------|--|--|--------------|---|---------|

GREASABLE SHACKLES AND PINS

| | | | | | |
|-------------------|-----------------|--|--------------|---|---------|
| Greasable Shackle | Left Hand Side | | 348RH | 1 | \$74.00 |
| Greasable Shackle | Right Hand Side | | 348LH | 1 | \$74.00 |
| Greasable Pin | | | 351 | 2 | \$44.00 |

HELPER SPRINGS

| | | | | | |
|--------------------------|--|--|------------|---|----------|
| Load Plus Helper Springs | | | LP4 | 1 | \$165.00 |
|--------------------------|--|--|------------|---|----------|

SUSPENSION KIT - Specify Front Leaf Springs When Ordering

| | | |
|------------------------|------------------|-----------|
| Medium - Nitro Gas | TOY004BKG | \$2520.00 |
| Medium - Foam Cell | TOY004BKF | \$2809.00 |
| Medium - Foam Cell Pro | TOY004BKP | \$3156.00 |

SUSPENSION KIT CONTENTS

Shock Absorbers Leaf Springs U-Bolts Polyurethane Spring Bushes



40 Series
1960 to 1980

Toyota Landcruiser

Product Description

Part No.

Qty
ReqRetail
ea Inc GST

Please check vehicle date range (if shown) next to product description prior to ordering

SUSPENSION TO SUIT TOYOTA LANDCRUISER 40 SERIES - 1960-1980

FRONT SUSPENSION

SHOCK ABSORBER

| | | | | | |
|-----------------------------|--|--|-----------------|---|----------|
| Nitro Gas - Comfort | | | 12635GRC | 2 | \$160.00 |
| Nitro Gas - Performance | | | 12635GR | 2 | \$160.00 |
| Foam Cell - Comfort | | | 24635FEC | 2 | \$216.00 |
| Foam Cell - Performance | | | 24635FE | 2 | \$232.00 |
| Foam Cell Pro - Performance | | | 45635FE | 2 | \$319.00 |

LEAF SPRINGS

| | Est. Lift | Additional Load | | | |
|--------|-----------|-----------------|----------------|---|----------|
| Medium | 50mm | 0 - 100kg | TOY001B | 2 | \$392.00 |

STEERING DAMPER

| | | | | | |
|-----------|--|--|-------------|---|----------|
| Foam Cell | | | 3523 | 1 | \$175.00 |
|-----------|--|--|-------------|---|----------|

U-BOLTS

| | | | | | |
|------------|--|--|---------------|---|---------|
| U-Bolt Kit | | | 415UBK | 2 | \$44.00 |
|------------|--|--|---------------|---|---------|

POLYURETHANE SPRING BUSHES

| | | | | | |
|----------|--|--|--------------|---|---------|
| Bush Kit | | | 713UK | 1 | \$74.00 |
|----------|--|--|--------------|---|---------|

GREASABLE SHACKLES AND PINS

| | | | | | |
|-------------------|--|-----------------|--------------|---|---------|
| Greasable Shackle | | Left Hand Side | 343LH | 1 | \$74.00 |
| Greasable Shackle | | Right Hand Side | 343RH | 1 | \$74.00 |
| Greasable Pin | | | 346 | 2 | \$44.00 |

REAR SUSPENSION

SHOCK ABSORBER

| | | | | | |
|------------------------------|--|--|-----------------|---|----------|
| Nitro Gas - Comfort | | | 12636GRC | 2 | \$160.00 |
| Nitro Gas - Performance | | | 12636GR | 2 | \$160.00 |
| Nitro Gas - Professional | | | 12636GRP | 2 | \$160.00 |
| Foam Cell - Comfort | | | 24636FEC | 2 | \$232.00 |
| Foam Cell - Performance | | | 24636FE | 2 | \$232.00 |
| Foam Cell - Professional | | | 24636FEP | 2 | \$232.00 |
| Foam Cell Pro - Comfort | | | 45636FEC | 2 | \$319.00 |
| Foam Cell Pro - Performance | | | 45636FE | 2 | \$319.00 |
| Foam Cell Pro - Professional | | | 45636FEP | 2 | \$319.00 |

LEAF SPRINGS

| | Est. Lift | Additional Load | | | |
|--------|-----------|-----------------|----------------|---|----------|
| Medium | 50mm | 0 - 200kg | TOY002B | 2 | \$392.00 |

U-BOLTS

| | | | | | |
|------------|--|--|---------------|---|---------|
| U-Bolt Kit | | | 415UBK | 2 | \$44.00 |
|------------|--|--|---------------|---|---------|

POLYURETHANE SPRING BUSHES

| | | | | | |
|----------|--|--|--------------|---|---------|
| Bush Kit | | | 713UK | 1 | \$74.00 |
|----------|--|--|--------------|---|---------|

GREASABLE SHACKLES AND PINS

| | | | | | |
|-------------------|--|-----------------|--------------|---|---------|
| Greasable Shackle | | Left Hand Side | 343RH | 1 | \$74.00 |
| Greasable Shackle | | Right Hand Side | 343LH | 1 | \$74.00 |
| Greasable Pin | | | 346 | 2 | \$44.00 |

HELPER SPRINGS

| | | | | | |
|--------------------------|--|--|------------|---|----------|
| Load Plus Helper Springs | | | LP4 | 1 | \$165.00 |
|--------------------------|--|--|------------|---|----------|

SUSPENSION KIT

| | | | | | |
|------------------------|--|--|------------------|--|-----------|
| Medium - Nitro Gas | | | TOY001BKG | | \$2520.00 |
| Medium - Foam Cell | | | TOY001BKF | | \$2809.00 |
| Medium - Foam Cell Pro | | | TOY001BKP | | \$3156.00 |

SUSPENSION KIT CONTENTS

Shock Absorbers

Leaf Springs

U-Bolts

Polyurethane Spring Bushes



Product Description

Part No.

Qty
Req

Retail
ea Inc GST

Please check vehicle date range (if shown) next to product description prior to ordering

ACCESSORIES TO SUIT TOYOTA PRADO 150 - 11/2017+

| Product Description | Part No. | Qty Req | Retail ea Inc GST |
|---|------------------|---------|-------------------|
| STEEL WINCH BULL BARS | | | |
| Premium - 60.3mm Tube | BBP064 | | \$2523.00 |
| Proguard No Loop | BBT064-NL | | \$1973.00 |
| Proguard Single Loop Kit | BB064-SL | | \$352.00 |
| Proguard Triple Loop Kit | BB064-TL | | \$423.00 |
| • Winch with Steel Cable and Roller Fairlead is not suitable - Use Winch with Synthetic Rope and Alloy Hawse only | | | |
| STEEL SIDE STEPS AND RAILS | | | |
| Premium Side Steps - 60.3mm Tube - Not compatible with KDSS models | SSP064 | | \$1103.00 |
| Premium Side Rails - 60.3mm Tube - Not compatible with KDSS models | SSP064 RAIL | | \$402.00 |
| Premium Side Steps and Rails - 60.3mm Tube - Not compatible with KDSS models | SSRP064 | | \$1334.00 |
| RECOVERY POINTS - IRONMAN 4X4 BULL BAR ONLY | | | |
| Recovery Points - 5000kg Rating (Pair) | IRP064 | | \$340.00 |
| LOCKSAFE DRAWER SYSTEMS | | | |
| Twin Drawers - 900mm | ITD900 | | \$1298.00 |
| Single Drawer - 900mm | ISD900 | | \$802.00 |
| Wing Kit - 900mm | ITDW064 | | \$283.00 |
| Mounting Kit | ITDFK064 | | \$159.00 |
| BATTERY TRAY | | | |
| Suits 12" Battery | IBTRAY064 | | \$145.00 |
| SNORKEL | | | |
| Engine 2.8 1GD-FTV Diesel | ISNORKEL064 | | \$437.00 |
| PREMIUM UNDERBODY PROTECTION | | | |
| Engine Bay and Transmission for models without KDSS | UBP047 | | \$782.00 |
| ATLAS ROOF RACK KITS | | | |
| Platform E with Blade Fit Kit - 2130mm Length | IFR047PEK | | \$2005.00 |
| Crossbar (x 3) and Fit Kit - 1375mm Width | IFR047C3K | | \$710.00 |
| • See Page 36 and 37 for more Atlas rack and crossbar options. | | | |
| STEEL ROOF RACKS | | | |
| Cage Style - 1.8m x 1.25m | IRRCAGE18 | | \$852.00 |
| Rooftop Tent Compatible - 1.8m x 1.25m | IRRTENT18 | | \$812.00 |
| Trade Style - 1.8m x 1.25m (Open end) | IRRTRADE18 | | \$812.00 |
| ALLOY ROOF RACKS | | | |
| Cage Style - 1.8m x 1.25m | IRRCAGE18-ALLOY | | \$1201.00 |
| Trade Style - 1.8m x 1.25m (Open end) | IRRTRADE18-ALLOY | | \$1183.00 |
| Flat Rack - 1.8m x 1.25m | IRRFLAT18-ALLOY | | \$1167.00 |
| STEEL AND ALLOY ROOF RACK - MOUNT KITS | | | |
| Toyota Prado 150 Mount Feet (2 Feet) | IRRFEETPRADO150 | | \$228.00 |
| SEAT COVER | | | |
| Canvas Comfort - Front | ICSC047F | | \$420.00 |
| Canvas Comfort - Rear | ICSC047R | | \$420.00 |
| BREATHER KIT | | | |
| Universal Twin Manifold Filtered Breather Kit | IDIFFBRE | | \$115.00 |



150 Series (Coil)
12/2017+

SUSPENSION TO SUIT

Toyota Prado

Product Description

Part No.

Qty
Req

Retail
ea Inc GST

Please check vehicle date range (if shown) next to product description prior to ordering

SUSPENSION TO SUIT TOYOTA PRADO 150 - 12/2017+

FRONT SUSPENSION

SHOCK ABSORBER

| | | | | | |
|-----------------------------------|--|--|----------------|---|----------|
| Nitro Gas Strut - Performance | | | 12710GR | 2 | \$232.00 |
| Foam Cell Strut - Performance | | | 24710FE | 2 | \$262.00 |
| Foam Cell Pro Strut - Performance | | | 45710FE | 2 | \$406.00 |

• Foam Cell Pro, must fit 1198K or 1209K spacer for Sway Bar clearance

COIL SPRINGS

| | Est. Lift | Additional Load | | | |
|--------|-----------|-----------------|----------------|---|----------|
| Light | 45mm | 0 - 50kg | TOY065A | 1 | \$262.00 |
| Medium | 45mm | 0 - 50kg | TOY065B | 1 | \$262.00 |
| Heavy | 45mm | 50 - 110kg | TOY065C | 1 | \$262.00 |

STRUT MOUNTS

| | | | | | |
|-----------------|--|--|----------------|---|---------|
| Steel Strut Top | | | ISST001 | 2 | \$88.00 |
|-----------------|--|--|----------------|---|---------|

TRIM PACKERS

| | | | | |
|------------------------|-----------------------|-------------------------|---|---------|
| 5mm Strut Trim Packer | Nitro Gas / Foam Cell | HILFR05/HILFR05F | 2 | \$30.00 |
| 10mm Strut Trim Packer | Nitro Gas / Foam Cell | HILFR10/HILFR10F | 2 | \$30.00 |
| 15mm Strut Trim Packer | Nitro Gas / Foam Cell | HILFR15/HILFR15F | 2 | \$30.00 |

• ONLY Compatible with Ironman 4x4 Struts (except Pro), lift height subject to 2:1 motion ratio. Unnecessary fitment may lift vehicle too high

CONTROL ARMS

| | | | | | |
|------------------------------|--|--|-----------------|---|----------|
| Pro-Forge Upper Control Arms | | | UCA001FA | 1 | \$882.00 |
|------------------------------|--|--|-----------------|---|----------|

SPACER KIT

| | | | | | |
|-------------------------|--|--|--------------|---|----------|
| Sway Bar Spacer | | | 1198K | 1 | \$102.00 |
| Offset Sway Bar Bracket | | | 1209K | 1 | \$146.00 |

REAR SUSPENSION

SHOCK ABSORBER

| | | | | | |
|------------------------------|--|--|-----------------|---|----------|
| Nitro Gas - Performance | | | 12682GRC | 2 | \$160.00 |
| Nitro Gas - Professional | | | 12682GRP | 2 | \$160.00 |
| Foam Cell - Performance | | | 24682FEC | 2 | \$232.00 |
| Foam Cell - Professional | | | 24682FEP | 2 | \$232.00 |
| Foam Cell Pro - Performance | | | 45682FEC | 2 | \$319.00 |
| Foam Cell Pro - Professional | | | 45682FEP | 2 | \$319.00 |

COIL SPRINGS

| | Est. Lift | Additional Load | | | |
|---------------------------|-----------|-----------------|----------------|---|----------|
| Medium | 45mm | 0 - 300kg | TOY056B | 1 | \$262.00 |
| Medium - with Accessories | 50mm | 200 - 400kg | TOY069B | 1 | \$262.00 |
| Heavy | 45mm | 300kg - GVM | TOY056C | 1 | \$262.00 |

PANHARD ROD

| | | | | | |
|--|--|--|------------------------|---|----------|
| Adjustable Panhard Rod for models without KDSS | | | PANHARD015 | 1 | \$334.00 |
| Adjustable Panhard Rod for models with KDSS | | | PANHARD015-KDSS | 1 | \$334.00 |

COIL SPACER

| | | | | | |
|-------------------|--|--|---------------|---|---------|
| Polyurethane 20mm | | | LCPR20 | 2 | \$30.00 |
| Polyurethane 25mm | | | LCPR25 | 2 | \$44.00 |

SWAY BAR LINK

| | | | | | |
|--|--|--|-----------------|---|----------|
| Extended Sway Bar Link for models without KDSS | | | SBEXT006 | 2 | \$88.00 |
| Rear Sway Bar Spacer for models with KDSS | | | 1220K | 1 | \$149.00 |

BUMP STOP

| | | | | | |
|---|--|--|----------------|---|----------|
| Internal Rubber Cone | | | 1218R | 2 | \$135.00 |
| Airbag Delete Kit for models with Airbags | | | 1218ADK | 1 | \$456.00 |

SUSPENSION KIT - Specify Front Coil Springs When Ordering

| | | |
|------------------------|-------------------|-----------|
| Medium - Nitro Gas | TOY065BKG2 | \$1304.00 |
| Medium - Foam Cell | TOY065BKF2 | \$1506.00 |
| Medium - Foam Cell Pro | TOY065BKP2 | \$2115.00 |
| Heavy - Nitro Gas | TOY065CKG2 | \$1304.00 |
| Heavy - Foam Cell | TOY065CKF2 | \$1506.00 |
| Heavy - Foam Cell Pro | TOY065CKP2 | \$2115.00 |

• All kits compatible with KDSS, refer KDSS instructions available at www.ironman4x4.com

SUSPENSION KIT CONTENTS

Shock Absorbers

Coil Springs

Strut Shock Absorbers

Offset Sway Bar Bracket (Pro Kits Only)

THIS OR THAT



PREMIUM BULL BAR
TRIPLE LOOP FULL FEATURE BAR



RAID BULL BAR
NO LOOP INTEGRATED BAR



Toyota Prado

150 Series
11/2009 to 10/2013
11/2013 to 10/2017

Product Description

Part No.

Qty
ReqRetail
ea Inc GST

Please check vehicle date range (if shown) next to product description prior to ordering

ACCESSORIES TO SUIT TOYOTA PRADO 150 - 11/2009-10/2017

STEEL WINCH BULL BARS

Commercial* - (11/2013 to 10/2017) - *While Stocks Last*

BBC047

\$1426.00

Commercial Deluxe* - (11/2009 to 10/2013)

BBCD029

\$2387.00

Commercial Deluxe* - (11/2013 to 10/2017)

BBCD047

\$2387.00

* Not compatible with sensors or headlight washers.

STEEL SIDE STEPS AND RAILS

Side Steps - Not compatible with KDSS models

SS047

\$1006.00

Side Steps and Rails - Not compatible with KDSS models

SSR047

\$1207.00

RECOVERY POINTS - IRONMAN 4X4 BULL BAR ONLY

Recovery Points - 5000kg Rating (Pair)

IRP064

\$340.00

LOCKSAFE DRAWER SYSTEMS

Twin Drawers - 900mm

ITD900

\$1298.00

Single Drawer - 900mm

ISD900

\$802.00

Wing Kit - 900mm

ITDW064

\$283.00

Mounting Kit

ITDFK064

\$159.00

BATTERY TRAY

Suits 12" Battery

IBTRAY064

\$145.00

SNORKEL

3L D4D TDi / 2.8L D4D TDi / 4L Petrol V6

ISNORKEL035

\$437.00

PREMIUM UNDERBODY PROTECTION

Engine Bay and Transmission for models without KDSS

UBP047

\$782.00

ATLAS ROOF RACK KITS

Platform E with Blade Fit Kit - 2130mm Length

IFR047PEK

\$2005.00

Crossbar (x 3) and Fit Kit - 1375mm Width

IFR047C3K

\$710.00

• See Page 36 and 37 for more Atlas rack and crossbar options.

STEEL ROOF RACKS

Cage Style - 1.8m x 1.25m

IRRCAGE18

\$852.00

Rooftop Tent Compatible - 1.8m x 1.25m

IRRTENT18

\$812.00

Trade Style - 1.8m x 1.25m (Open end)

IRRTRADE18

\$812.00

ALLOY ROOF RACKS

Cage Style - 1.8m x 1.25m

IRRCAGE18-ALLOY

\$1201.00

Trade Style - 1.8m x 1.25m (Open end)

IRRTRADE18-ALLOY

\$1183.00

Flat Rack - 1.8m x 1.25m

IRRTFLAT18-ALLOY

\$1167.00

STEEL AND ALLOY ROOF RACK - MOUNT KITS

Toyota Prado 150 Mount Feet (2 Feet)

IRRFEETPRADO150

\$228.00

SEAT COVER

Canvas Comfort - Front

ICSC047F

\$420.00

Canvas Comfort - Rear

ICSC047R

\$420.00

BREATHER KIT

Universal Twin Manifold Filtered Breather Kit

IDIFFBRE

\$115.00

LISTING
CONTINUED
OVER THE
PAGE

Toyota Prado

150 Series (Coil)
2009 to 11/2017



Product Description

Part No.

Qty
Req

Retail
ea Inc GST

Please check vehicle date range (if shown) next to product description prior to ordering

SUSPENSION TO SUIT TOYOTA PRADO 150 - 2009-11/2017

FRONT SUSPENSION

SHOCK ABSORBER

| | | | | | |
|-----------------------------------|--|--|----------------|---|----------|
| Nitro Gas Strut - Performance | | | 12750GR | 2 | \$232.00 |
| Foam Cell Strut - Performance | | | 24750FE | 2 | \$262.00 |
| Foam Cell Pro Strut - Performance | | | 45750FE | 2 | \$406.00 |

• Foam Cell Pro, must fit 1198K or 1209K spacer for Sway Bar clearance

COIL SPRINGS

| | Est. Lift | Additional Load | | | |
|-----------------|-----------|-----------------|----------------|---|----------|
| Light | 45mm | 0 - 50kg | TOY065A | 1 | \$262.00 |
| Medium - Petrol | 45mm | 0 - 50kg | TOY065B | 1 | \$262.00 |
| Heavy - Diesel | 45mm | 50 - 110kg | TOY065C | 1 | \$262.00 |

STRUT MOUNTS

| | | | | | |
|-----------------|--|--|----------------|---|---------|
| Steel Strut Top | | | ISST001 | 2 | \$88.00 |
|-----------------|--|--|----------------|---|---------|

TRIM PACKERS

| | | | | |
|------------------------|-----------------------|-------------------------|---|---------|
| 5mm Strut Trim Packer | Nitro Gas / Foam Cell | HILFR05/HILFR05F | 2 | \$30.00 |
| 10mm Strut Trim Packer | Nitro Gas / Foam Cell | HILFR10/HILFR10F | 2 | \$30.00 |
| 15mm Strut Trim Packer | Nitro Gas / Foam Cell | HILFR15/HILFR15F | 2 | \$30.00 |

• ONLY Compatible with Ironman 4x4 Struts (except Pro), lift height subject to 2:1 motion ratio. Unnecessary fitment may lift vehicle too high

CONTROL ARMS

| | | | | | |
|------------------------------|--|--|-----------------|---|----------|
| Pro-Forge Upper Control Arms | | | UCA001FA | 1 | \$882.00 |
|------------------------------|--|--|-----------------|---|----------|

SPACER KIT

| | | | | | |
|-------------------------|--|--|--------------|---|----------|
| Sway Bar Spacer | | | 1198K | 1 | \$102.00 |
| Offset Sway Bar Bracket | | | 1209K | 1 | \$146.00 |

REAR SUSPENSION

SHOCK ABSORBER

| | | | | | |
|------------------------------|--|--|-----------------|---|----------|
| Nitro Gas - Performance | | | 12682GRC | 2 | \$160.00 |
| Nitro Gas - Professional | | | 12682GRP | 2 | \$160.00 |
| Foam Cell - Performance | | | 24682FEC | 2 | \$232.00 |
| Foam Cell - Professional | | | 24682FEP | 2 | \$232.00 |
| Foam Cell Pro - Performance | | | 45682FEC | 2 | \$319.00 |
| Foam Cell Pro - Professional | | | 45682FEP | 2 | \$319.00 |

COIL SPRINGS

| | Est. Lift | Additional Load | | | |
|-------------------------------|-----------|-----------------|----------------|---|----------|
| Medium - SWB | 45mm | 0 - 300kg | TOY056A | 1 | \$262.00 |
| Medium - LWB | 45mm | 0 - 300kg | TOY056B | 1 | \$262.00 |
| Medium - LWB with Accessories | 50mm | 200 - 400kg | TOY069B | 1 | \$262.00 |
| Heavy | 45mm | 300kg - GVM | TOY056C | 1 | \$262.00 |

PANHARD ROD

| | | | | | |
|--|--|--|------------------------|---|----------|
| Adjustable Panhard Rod for models without KDSS | | | PANHARD015 | 1 | \$334.00 |
| Adjustable Panhard Rod for models with KDSS | | | PANHARD015-KDSS | 1 | \$334.00 |

COIL SPACER

| | | | | | |
|-------------------|--|--|---------------|---|---------|
| Polyurethane 20mm | | | LCPR20 | 2 | \$30.00 |
| Polyurethane 25mm | | | LCPR25 | 2 | \$44.00 |

SWAY BAR LINK

| | | | | | |
|--|--|--|-----------------|---|----------|
| Extended Sway Bar Link for models without KDSS | | | SBEXT006 | 2 | \$88.00 |
| Rear Sway Bar Spacer for models with KDSS | | | 1220K | 1 | \$149.00 |

BUMP STOP

| | | | | | |
|---|--|--|----------------|---|----------|
| Internal Rubber Cone | | | 1218R | 2 | \$135.00 |
| Airbag Delete Kit for models with Airbags | | | 1218ADK | 1 | \$456.00 |

Toyota Prado



150 Series (Coil)
2009 to 11/2017

| Product Description | Part No. | Qty Req | Retail ea Inc GST |
|---------------------|----------|---------|-------------------|
|---------------------|----------|---------|-------------------|

Please check vehicle date range (if shown) next to product description prior to ordering

SUSPENSION KIT - Specify Front Coil Springs When Ordering

| | | | | |
|------------------------|-----|--------|------------|-----------|
| Medium - Nitro Gas | SWB | Petrol | TOY065AKG | \$1304.00 |
| Medium - Nitro Gas | SWB | Diesel | TOY065AKG1 | \$1304.00 |
| Medium - Nitro Gas | LWB | Petrol | TOY065BKG | \$1304.00 |
| Medium - Nitro Gas | LWB | Diesel | TOY065BKG1 | \$1304.00 |
| Medium - Foam Cell | SWB | Petrol | TOY065AKF | \$1506.00 |
| Medium - Foam Cell | SWB | Diesel | TOY065AKF1 | \$1506.00 |
| Medium - Foam Cell | LWB | Petrol | TOY065BKF | \$1506.00 |
| Medium - Foam Cell | LWB | Diesel | TOY065BKF1 | \$1506.00 |
| Medium - Foam Cell Pro | SWB | Petrol | TOY065AKP | \$2115.00 |
| Medium - Foam Cell Pro | SWB | Diesel | TOY065AKP1 | \$2115.00 |
| Medium - Foam Cell Pro | LWB | Petrol | TOY065BKP | \$2115.00 |
| Medium - Foam Cell Pro | LWB | Diesel | TOY065BKP1 | \$2115.00 |
| Heavy - Nitro Gas | LWB | Petrol | TOY065CKG | \$1304.00 |
| Heavy - Nitro Gas | LWB | Diesel | TOY065CKG1 | \$1304.00 |
| Heavy - Foam Cell | LWB | Petrol | TOY065CKF | \$1506.00 |
| Heavy - Foam Cell | LWB | Diesel | TOY065CKF1 | \$1506.00 |
| Heavy - Foam Cell Pro | LWB | Petrol | TOY065CKP | \$2115.00 |
| Heavy - Foam Cell Pro | LWB | Diesel | TOY065CKP1 | \$2115.00 |

• All kits compatible with KDSS, refer KDSS instructions available at www.ironman4x4.com

SUSPENSION KIT CONTENTS

| Shock Absorbers | Strut Shock Absorbers | Coil Springs | Offset Sway Bar Bracket (Pro Kits Only) |
|-----------------|-----------------------|--------------|---|
|-----------------|-----------------------|--------------|---|



Toyota Prado

120 Series
4/2003 to 10/2009



Product Description

Part No.

Qty
Req

Retail
ea Inc GST

Please check vehicle date range (if shown) next to product description prior to ordering

ACCESSORIES TO SUIT TOYOTA PRADO 120 - 4/2003-10/2009

STEEL WINCH BULL BARS

| | | | |
|-------------------|---------|--|-----------|
| Commercial Deluxe | BBCD008 | | \$2345.00 |
|-------------------|---------|--|-----------|

STEEL SIDE STEPS AND RAILS

| | | | |
|----------------------|--------|--|-----------|
| Side Steps | SS017 | | \$1006.00 |
| Side Steps and Rails | SSR004 | | \$1207.00 |

LOCKSAFE DRAWER SYSTEMS

| | | | |
|-----------------------|--------|--|-----------|
| Twin Drawers - 900mm | ITD900 | | \$1298.00 |
| Single Drawer - 900mm | ISD900 | | \$802.00 |

SNORKEL

| | | | |
|---------------------------|-------------|--|----------|
| 3L D4D TDi / 4L Petrol V6 | ISNORKEL006 | | \$437.00 |
|---------------------------|-------------|--|----------|

STEEL ROOF RACKS

| | | | |
|--|------------|--|----------|
| Cage Style - 1.8m x 1.25m | IRRCAGE18 | | \$852.00 |
| Rooftop Tent Compatible - 1.8m x 1.25m | IRRTENT18 | | \$812.00 |
| Trade Style - 1.8m x 1.25m (Open end) | IRRTRADE18 | | \$812.00 |

ALLOY ROOF RACKS

| | | | |
|---------------------------------------|------------------|--|-----------|
| Cage Style - 1.8m x 1.25m | IRRCAGE18-ALLOY | | \$1201.00 |
| Trade Style - 1.8m x 1.25m (Open end) | IRRTRADE18-ALLOY | | \$1183.00 |
| Flat Rack - 1.8m x 1.25m | IRRFLAT18-ALLOY | | \$1167.00 |

STEEL AND ALLOY ROOF RACK - MOUNT KITS

| | | | |
|------------------------------------|--------------|--|----------|
| Gutter Mount Feet - 200mm (8 Feet) | IRRFEETLC200 | | \$207.00 |
|------------------------------------|--------------|--|----------|

BREATHER KIT

| | | | |
|---|----------|--|----------|
| Universal Twin Manifold Filtered Breather Kit | IDIFFBRE | | \$115.00 |
|---|----------|--|----------|

SUSPENSION TO SUIT TOYOTA PRADO 120 - 4/2003-10/2009

FRONT SUSPENSION

SHOCK ABSORBER

| | | | |
|-----------------------------------|---------|---|----------|
| Nitro Gas Strut - Performance | 12710GR | 2 | \$232.00 |
| Foam Cell Strut - Performance | 24710FE | 2 | \$262.00 |
| Foam Cell Pro Strut - Performance | 45710FE | 2 | \$406.00 |

• Foam Cell Pro, must fit 1198K spacer for Sway Bar clearance

COIL SPRINGS

| | Est. Lift | Additional Load | | | |
|-----------------|-----------|-----------------|---------|---|----------|
| Light | 30mm | 0 - 50kg | TOY055A | 1 | \$262.00 |
| Medium - Petrol | 45mm | 0 - 50kg | TOY055B | 1 | \$262.00 |
| Heavy - Diesel | 45mm | 50 - 110kg | TOY055C | 1 | \$262.00 |

STRUT MOUNTS

| | | | |
|-----------------|---------|---|---------|
| Steel Strut Top | ISST001 | 2 | \$88.00 |
|-----------------|---------|---|---------|

TRIM PACKERS

| | | | | |
|------------------------|-----------------------|------------------|---|---------|
| 5mm Strut Trim Packer | Nitro Gas / Foam Cell | HILFR05/HILFR05F | 2 | \$30.00 |
| 10mm Strut Trim Packer | Nitro Gas / Foam Cell | HILFR10/HILFR10F | 2 | \$30.00 |
| 15mm Strut Trim Packer | Nitro Gas / Foam Cell | HILFR15/HILFR15F | 2 | \$30.00 |

• ONLY Compatible with Ironman 4x4 Struts (except Pro), lift height subject to 2:1 motion ratio. Unnecessary fitment may lift vehicle too high

CONTROL ARMS

| | | | |
|------------------------------|----------|---|----------|
| Pro-Forge Upper Control Arms | UCA001FA | 1 | \$882.00 |
|------------------------------|----------|---|----------|

SPACER KIT

| | | | |
|-----------------|-------|---|----------|
| Sway Bar Spacer | 1198K | 1 | \$102.00 |
|-----------------|-------|---|----------|

Toyota Prado

120 Series
4/2003 to 10/2009

Product Description

Part No.

Qty
ReqRetail
ea Inc GST*Please check vehicle date range (if shown) next to product description prior to ordering***REAR SUSPENSION****SHOCK ABSORBER**

| | | | | | |
|------------------------------|--|--|-----------------|---|----------|
| Nitro Gas - Performance | | | 12682GRC | 2 | \$160.00 |
| Nitro Gas - Professional | | | 12682GRP | 2 | \$160.00 |
| Foam Cell - Performance | | | 24682FEC | 2 | \$232.00 |
| Foam Cell - Professional | | | 24682FEP | 2 | \$232.00 |
| Foam Cell Pro - Performance | | | 45682FEC | 2 | \$319.00 |
| Foam Cell Pro - Professional | | | 45682FEP | 2 | \$319.00 |

COIL SPRINGS

| | Est. Lift | Additional Load | | | |
|-------------------------------|-----------|-----------------|----------------|---|----------|
| Medium - SWB | 45mm | 0 - 300kg | TOY056A | 1 | \$262.00 |
| Medium - LWB | 45mm | 0 - 300kg | TOY056B | 1 | \$262.00 |
| Medium - with accessories LWB | 50mm | 200 - 400kg | TOY069B | 1 | \$262.00 |
| Heavy | 45mm | 300kg - GVM | TOY056C | 1 | \$262.00 |

PANHARD ROD

| | | | | | |
|--|--|--|------------------------|---|----------|
| Adjustable Panhard Rod for models without KDSS | | | PANHARD015 | 1 | \$334.00 |
| Adjustable Panhard Rod for models with KDSS | | | PANHARD015-KDSS | 1 | \$334.00 |

SWAY BAR LINK

| | | | | | |
|--|--|--|-----------------|---|----------|
| Extended Sway Bar Link for models without KDSS | | | SBEXT006 | 2 | \$88.00 |
| Rear Sway Bar Spacer for models with KDSS | | | 1220K | 1 | \$149.00 |

BUMP STOP

| | | | | | |
|---|--|--|----------------|---|----------|
| Internal Rubber Cone | | | 1218R | 2 | \$135.00 |
| Airbag Delete Kit for models with Airbags | | | 1218ADK | 1 | \$456.00 |

SUSPENSION KIT - Specify Front Coil Springs When Ordering

| | | | | | |
|------------------------|-----|--------|-------------------|--|-----------|
| Medium - Nitro Gas | SWB | Petrol | TOY055AKG | | \$1304.00 |
| Medium - Nitro Gas | SWB | Diesel | TOY055AKG1 | | \$1304.00 |
| Medium - Nitro Gas | LWB | Petrol | TOY055BKG | | \$1304.00 |
| Medium - Nitro Gas | LWB | Diesel | TOY055BKG1 | | \$1304.00 |
| Medium - Foam Cell | SWB | Petrol | TOY055AKF | | \$1506.00 |
| Medium - Foam Cell | SWB | Diesel | TOY055AKF1 | | \$1506.00 |
| Medium - Foam Cell | LWB | Petrol | TOY055BKF | | \$1506.00 |
| Medium - Foam Cell | LWB | Diesel | TOY055BKF1 | | \$1506.00 |
| Medium - Foam Cell Pro | SWB | Petrol | TOY055AKP | | \$2115.00 |
| Medium - Foam Cell Pro | SWB | Diesel | TOY055AKP1 | | \$2071.00 |
| Medium - Foam Cell Pro | LWB | Petrol | TOY055BKP | | \$2115.00 |
| Medium - Foam Cell Pro | LWB | Diesel | TOY055BKP1 | | \$2071.00 |
| Heavy - Nitro Gas | LWB | Petrol | TOY055CKG | | \$1304.00 |
| Heavy - Nitro Gas | LWB | Diesel | TOY055CKG1 | | \$1304.00 |
| Heavy - Foam Cell | LWB | Petrol | TOY055CKF | | \$1506.00 |
| Heavy - Foam Cell | LWB | Diesel | TOY055CKF1 | | \$1506.00 |
| Heavy - Foam Cell Pro | LWB | Petrol | TOY055CKP | | \$2115.00 |
| Heavy - Foam Cell Pro | LWB | Diesel | TOY055CKP1 | | \$2071.00 |

SUSPENSION KIT CONTENTS

Shock Absorbers

Strut Shock Absorbers

Coil Springs

Sway Bar Spacer (Pro Kits Only)

Toyota Prado

90, 95 Series
1996 to 10/2002



Product Description

Part No.

Qty
Req

Retail
ea Inc GST

Please check vehicle date range (if shown) next to product description prior to ordering

ACCESSORIES TO SUIT TOYOTA PRADO 90, 95 - 1996-10/2002

STEEL WINCH BULL BARS

| | | |
|-------------------|---------|-----------|
| Commercial Deluxe | BBCD007 | \$2345.00 |
|-------------------|---------|-----------|

SNORKEL

| | | |
|----------------|-------------|----------|
| 3.4L Petrol V6 | ISNORKEL005 | \$437.00 |
|----------------|-------------|----------|

LOCKSAFE DRAWER SYSTEMS

| | | |
|----------------------|--------|-----------|
| Twin Drawers - 900mm | ITD900 | \$1298.00 |
|----------------------|--------|-----------|

| | | |
|-----------------------|--------|----------|
| Single Drawer - 900mm | ISD900 | \$802.00 |
|-----------------------|--------|----------|

| | | |
|------------------------|---------|----------|
| Wing Kit - 900mm (GXL) | ITDW004 | \$283.00 |
|------------------------|---------|----------|

STEEL ROOF RACKS

| | | |
|---------------------------|-----------|----------|
| Cage Style - 1.8m x 1.25m | IRRCAGE18 | \$852.00 |
|---------------------------|-----------|----------|

| | | |
|--|-----------|----------|
| Rooftop Tent Compatible - 1.8m x 1.25m | IRRTENT18 | \$812.00 |
|--|-----------|----------|

| | | |
|---------------------------------------|------------|----------|
| Trade Style - 1.8m x 1.25m (Open end) | IRRTRADE18 | \$812.00 |
|---------------------------------------|------------|----------|

ALLOY ROOF RACKS

| | | |
|---------------------------|-----------------|-----------|
| Cage Style - 1.8m x 1.25m | IRRCAGE18-ALLOY | \$1201.00 |
|---------------------------|-----------------|-----------|

| | | |
|---------------------------------------|------------------|-----------|
| Trade Style - 1.8m x 1.25m (Open end) | IRRTRADE18-ALLOY | \$1183.00 |
|---------------------------------------|------------------|-----------|

| | | |
|--------------------------|------------------|-----------|
| Flat Rack - 1.8m x 1.25m | IRRTFLAT18-ALLOY | \$1167.00 |
|--------------------------|------------------|-----------|

STEEL AND ALLOY ROOF RACK - MOUNT KITS

| | | |
|------------------------------------|------------|----------|
| Gutter Mount Feet - 125mm (8 Feet) | IRRFEET125 | \$207.00 |
|------------------------------------|------------|----------|

BREATHER KIT

| | | |
|---|----------|----------|
| Universal Twin Manifold Filtered Breather Kit | IDIFFBRE | \$115.00 |
|---|----------|----------|

Toyota Prado

90, 95 Series
1996 to 10/2002

Product Description

Part No.

Qty
ReqRetail
ea Inc GST*Please check vehicle date range (if shown) next to product description prior to ordering***SUSPENSION TO SUIT TOYOTA PRADO 90, 95 - 1996-10/2002****FRONT SUSPENSION****SHOCK ABSORBER**

| | | | | | |
|-----------------------------------|--|--|----------------|---|----------|
| Nitro Gas Strut - Performance | | | 12691GR | 2 | \$232.00 |
| Foam Cell Strut - Performance | | | 24691FE | 2 | \$262.00 |
| Foam Cell Pro Strut - Performance | | | 45691FE | 2 | \$406.00 |

COIL SPRINGS

| | Est. Lift | Additional Load | | | |
|-----------------|-----------|-----------------|----------------|---|----------|
| Medium - Petrol | 45mm | 0 - 50kg | TOY038B | 1 | \$262.00 |
| Heavy - Diesel | 45mm | 50 - 110kg | TOY038C | 1 | \$262.00 |

TRIM PACKERS

| | | | | |
|------------------------|-----------------------|-------------------------|---|---------|
| 5mm Strut Trim Packer | Nitro Gas / Foam Cell | HILFR05/HILFR05F | 2 | \$30.00 |
| 10mm Strut Trim Packer | Nitro Gas / Foam Cell | HILFR10/HILFR10F | 2 | \$30.00 |
| 15mm Strut Trim Packer | Nitro Gas / Foam Cell | HILFR15/HILFR15F | 2 | \$30.00 |

• ONLY Compatible with Ironman 4x4 Struts (except Pro), lift height subject to 2:1 motion ratio. Unnecessary fitment may lift vehicle too high

REAR SUSPENSION**SHOCK ABSORBER**

| | | | | | |
|-----------------------------|--|--|----------------|---|----------|
| Nitro Gas - Performance | | | 12661GR | 2 | \$160.00 |
| Foam Cell - Performance | | | 24661FE | 2 | \$232.00 |
| Foam Cell Pro - Performance | | | 45661FE | 2 | \$319.00 |

COIL SPRINGS

| | Est. Lift | Additional Load | | | |
|--------------|-----------|-----------------|----------------|---|----------|
| Medium - SWB | 45mm | 0 - 300kg | TOY039A | 1 | \$262.00 |
| Medium - LWB | 45mm | 0 - 300kg | TOY039B | 1 | \$262.00 |
| Heavy | 45mm | 300kg - GVM | TOY039C | 1 | \$262.00 |

COIL SPACER

| | | | | | |
|-------------------|--|--|--------------|---|---------|
| Polyurethane 20mm | | | LCF20 | 2 | \$30.00 |
| Polyurethane 30mm | | | LCF30 | 2 | \$44.00 |

SUSPENSION KIT - Specify Front Coil Springs When Ordering

| | | | | | |
|------------------------|-----|--------|-------------------|--|-----------|
| Medium - Nitro Gas | SWB | Petrol | TOY038AKG | | \$1304.00 |
| Medium - Nitro Gas | SWB | Diesel | TOY038AKG1 | | \$1304.00 |
| Medium - Nitro Gas | LWB | Petrol | TOY038BKG | | \$1304.00 |
| Medium - Nitro Gas | LWB | Diesel | TOY038CKG | | \$1304.00 |
| Medium - Foam Cell | SWB | Petrol | TOY038AKF | | \$1506.00 |
| Medium - Foam Cell | SWB | Diesel | TOY038AKF1 | | \$1506.00 |
| Medium - Foam Cell | LWB | Petrol | TOY038BKF | | \$1506.00 |
| Medium - Foam Cell | LWB | Diesel | TOY038CKF | | \$1506.00 |
| Medium - Foam Cell Pro | SWB | Petrol | TOY038AKP | | \$1969.00 |
| Medium - Foam Cell Pro | SWB | Diesel | TOY038AKP1 | | \$1969.00 |
| Medium - Foam Cell Pro | LWB | Petrol | TOY038BKP | | \$1969.00 |
| Medium - Foam Cell Pro | LWB | Diesel | TOY038CKP | | \$1969.00 |
| Heavy - Nitro Gas | LWB | Petrol | TOY038BKG1 | | \$1304.00 |
| Heavy - Nitro Gas | LWB | Diesel | TOY038CKG1 | | \$1304.00 |
| Heavy - Foam Cell | LWB | Petrol | TOY038BKF1 | | \$1506.00 |
| Heavy - Foam Cell | LWB | Diesel | TOY038CKF1 | | \$1506.00 |
| Heavy - Foam Cell Pro | LWB | Petrol | TOY038BKP1 | | \$1969.00 |
| Heavy - Foam Cell Pro | LWB | Diesel | TOY038CKP1 | | \$1969.00 |

SUSPENSION KIT CONTENTS

Shock Absorbers

Strut Shock Absorbers

Coil Springs

Toyota Tacoma

2005+



Product Description

Part No.

Qty
Req

Retail
ea Inc GST

Please check vehicle date range (if shown) next to product description prior to ordering

ACCESSORIES TO SUIT TOYOTA TACOMA - 2005+

STEEL WINCH BULL BARS

Raid Bull Bar **BBR072** \$1317.00

• Compatible with Ironman 4x4 Cube Lights and Lightbars, refer below for available options

LIGHTING OPTIONS - TO SUIT RAID BULL BARS (4-6 CUBE LIGHTS PER VEHICLE)

300W Bright Sabre Dual Row Lightbar 815mm **ILBDR002B** \$417.00

300W Bright Sabre Multi-Function Dual Row Lightbar 815mm **ILBDR002BM** \$470.00

40W Bright Cube Spot Beam LED Cube Light - 81 x 75mm - Clear **ILED80B** \$83.00

40W Bright Cube Spot Beam LED Cube Light - 81 x 75mm - Amber **ILED80BA** \$83.00

40W Bright Cube Flood Beam LED Cube Light - 81 x 75mm - Clear **ILED80BF** \$83.00

40W Bright Cube Flood Beam LED Cube Light - 81 x 75mm - Amber **ILED80BFA** \$83.00

10W Spot Beam Universal LED Light - 93mm L - Clear (3rd Light) **ILEDWL10** \$52.00

10W Flood Beam Universal LED Light - 93mm L - Amber (3rd Light) **ILEDWL10FA** \$52.00

STEEL SIDE STEPS

Raid Rock Slider 1960mm **SS072** \$1003.00

Raid Rock Slider 2390mm **SS072L** \$1003.00

• Long Bed Models Only

TOWING

Raid Rear Bumper **RTB072** \$1103.00

• Compatible with Ironman 4x4 Cube Lights, refer below for available options

LIGHTING OPTIONS - TO SUIT RAID REAR BARS (4 CUBE LIGHTS PER VEHICLE)

20W Bright Cube Spot Beam LED Cube Light - 70 x 64mm (Each) - Clear **ILED20B** \$62.00

20W Bright Cube Spot Beam LED Cube Light - 70 x 64mm (Each) - Amber **ILED20BA** \$62.00

20W Bright Cube Flood Beam LED Cube Light - 70 x 64mm (Each) - Clear **ILED20BF** \$62.00

20W Bright Cube Flood Beam LED Cube Light - 70 x 64mm (Each) - Amber **ILED20BFA** \$62.00

20W Bright Cube Flood Beam LED Cube Light - 70 x 64mm (Each) - Red **ILED20BFR** \$62.00

PREMIUM UNDERBODY PROTECTION

Engine Bay and Transmission **UBP072** \$745.00

SLIDE-AWAY ROLL UP HARD TONNEAU COVER

Electric with Remote Control (Long Bed) **ISLIDEAWAY072L-E** \$2821.00

Electric with Remote Control (Short Bed) **ISLIDEAWAY072S-E** \$2716.00

ATLAS RACK KITS

Platform S with Blade Fit Kit to Suit Slideaway Hard Tonneau Cover - 1390mm Length **IFRSLDAWAYPSK** \$1670.00

Crossbar (x 2) and Fit Kit to Suit Slideaway Hard Tonneau Cover - 1500mm Width **IFRSLDAWAYC2K** \$940.00

• See Page 36 and 37 for more Atlas rack and crossbar options.

BREATHER KIT

Universal Twin Manifold Filtered Breather Kit **IDIFFBRE** \$115.00



Toyota Tacoma



2005+

Product Description

Part No.

Qty
ReqRetail
ea Inc GST

Please check vehicle date range (if shown) next to product description prior to ordering

SUSPENSION TO SUIT TOYOTA TACOMA - 2005+

FRONT SUSPENSION

SHOCK ABSORBER

| | | | | | |
|-----------------------------------|--|--|----------------|---|----------|
| Nitro Gas Strut - Performance | | | 12710GR | 2 | \$232.00 |
| Foam Cell Strut - Performance | | | 24710FE | 2 | \$262.00 |
| Foam Cell Pro Strut - Performance | | | 45710FE | 2 | \$406.00 |

COIL SPRINGS

| | Est. L ift | Additional Load | | | |
|--------|------------|-----------------|----------------|---|----------|
| Light | 45mm | 0 - 50kg | TOY065A | 1 | \$262.00 |
| Medium | 45mm | 0 - 50kg | TOY065B | 1 | \$262.00 |
| Heavy | 45mm | 50 - 110kg | TOY065C | 1 | \$262.00 |

STRUT MOUNTS

| | | | | | |
|-----------------|--|--|----------------|---|---------|
| Steel Strut Top | | | ISST001 | 2 | \$88.00 |
|-----------------|--|--|----------------|---|---------|

TRIM PACKERS

| | | | | | |
|------------------------|-----------------------|--|-------------------------|---|---------|
| 5mm Strut Trim Packer | Nitro Gas / Foam Cell | | HILFR05/HILFR05F | 2 | \$30.00 |
| 10mm Strut Trim Packer | Nitro Gas / Foam Cell | | HILFR10/HILFR10F | 2 | \$30.00 |
| 15mm Strut Trim Packer | Nitro Gas / Foam Cell | | HILFR15/HILFR15F | 2 | \$30.00 |

• ONLY Compatible with Ironman 4x4 Struts (except Pro), lift height subject to 2:1 motion ratio. Unnecessary fitment may lift vehicle too high

CONTROL ARMS

| | | | | | |
|------------------------------|--|--|-----------------|---|----------|
| Pro-Forge Upper Control Arms | | | UCA001FA | 1 | \$882.00 |
|------------------------------|--|--|-----------------|---|----------|

SPACER KIT

| | | | | | |
|-----------------|--|--|--------------|---|----------|
| Sway Bar Spacer | | | 1198K | 1 | \$102.00 |
|-----------------|--|--|--------------|---|----------|

REAR SUSPENSION

SHOCK ABSORBER

| | | | | | |
|-----------------------------|--|--|----------------|---|----------|
| Nitro Gas - Performance | | | 12744GR | 2 | \$160.00 |
| Foam Cell - Performance | | | 24744FE | 2 | \$232.00 |
| Foam Cell Pro - Performance | | | 45744FE | 2 | \$291.00 |

LEAF SPRINGS

| | Est. Lift | Additional Load | | | |
|-----------------------|-----------|-----------------|-------------------|---|----------|
| Medium - Drivers Side | 50mm | 0 - 200kg | TOY066BD/S | 1 | \$537.00 |
| Medium - Near Side | 50mm | 0 - 200kg | TOY066BN/S | 1 | \$537.00 |
| Heavy - Drivers Side | 50mm | 200kg-GVM | TOY066CD/S | 1 | \$537.00 |
| Heavy - Near Side | 50mm | 200kg-GVM+ | TOY066CN/S | 1 | \$537.00 |

U-BOLTS

| | | | | | |
|------------|--|--|---------------|---|---------|
| U-Bolt Kit | | | 437UBK | 2 | \$44.00 |
|------------|--|--|---------------|---|---------|

POLYURETHANE SPRING BUSHES

| | | | | | |
|----------|--|--|---------------|---|---------|
| Bush Kit | | | 1191UK | 1 | \$88.00 |
|----------|--|--|---------------|---|---------|

SPACER KIT

| | | | | | |
|---------------------------|--|--|--------------|---|---------|
| Centre Bearing Spacer Kit | | | 1192K | 1 | \$30.00 |
|---------------------------|--|--|--------------|---|---------|

HELPER SPRINGS

| | | | | | |
|--------------------------|--|--|----------------|---|----------|
| Load Plus Helper Springs | | | LP3 | 1 | \$165.00 |
| Add-A-Leaf | | | ISL6010 | 1 | \$175.00 |

SUSPENSION KIT - Specify Front Coil Springs When Ordering

| | | |
|------------------------|------------------|-----------|
| Medium - Nitro Gas | TOY066BKG | \$2317.00 |
| Medium - Foam Cell | TOY066BKF | \$2520.00 |
| Medium - Foam Cell Pro | TOY066BKP | \$2983.00 |
| Heavy - Nitro Gas | TOY066CKG | \$2317.00 |
| Heavy - Foam Cell | TOY066CKF | \$2520.00 |
| Heavy - Foam Cell Pro | TOY066CKP | \$2983.00 |

SUSPENSION KIT CONTENTS

Shock Absorbers
Leaf Springs

Coil Springs
U-Bolts

Polyurethane Spring Bushes
Centre Bearing Spacer Kit

Strut Shock Absorbers

Toyota Tundra

2013 to 2020
2020 to 2021



Product Description

Part No.

Qty
Req

Retail
ea Inc GST

Please check vehicle date range (if shown) next to product description prior to ordering

ACCESSORIES TO SUIT TOYOTA TUNDRA - 2013-2021

STEEL WINCH BULL BARS

| | | |
|---------------|--------|-----------|
| Raid Bull Bar | BBR073 | \$1489.00 |
|---------------|--------|-----------|

• Compatible with Ironman 4x4 Cube Lights and Lightbars, refer below for available options

LIGHTING OPTIONS - TO SUIT RAID BULL BARS (4-6 CUBE LIGHTS PER VEHICLE)

| | | |
|---|------------|----------|
| 300W Bright Sabre Dual Row Lightbar 815mm | ILBDR002B | \$417.00 |
| 300W Bright Sabre Multi-Function Dual Row Lightbar 815mm | ILBDR002BM | \$470.00 |
| 40W Bright Cube Spot Beam LED Cube Light - 81 x 75mm - Clear | ILED80B | \$83.00 |
| 40W Bright Cube Spot Beam LED Cube Light - 81 x 75mm - Amber | ILED80BA | \$83.00 |
| 40W Bright Cube Flood Beam LED Cube Light - Clear | ILED80BF | \$83.00 |
| 40W Bright Cube Flood Beam LED Cube Light - 81 x 75mm - Amber | ILED80BFA | \$83.00 |
| 10W Spot Beam Universal LED Light - 93mm L - Clear (3rd Light) | ILEDWL10 | \$52.00 |
| 10W Flood Beam Universal LED Light - 93mm L - Amber (3rd Light) | ILEDWL10FA | \$52.00 |

STEEL SIDE STEPS

| | | |
|------------------|-------|-----------|
| Raid Rock Slider | SS073 | \$1003.00 |
|------------------|-------|-----------|

• Crew-Max Models only

TOWING

| | | |
|-------------------|--------|-----------|
| Raid Rear Bumper* | RTB073 | \$1103.00 |
|-------------------|--------|-----------|

* Not compatible with rear cross traffic radar models

• Compatible with Ironman 4x4 Cube Lights, refer below for available options

LIGHTING OPTIONS - TO SUIT RAID REAR BARS (4 CUBE LIGHTS PER VEHICLE)

| | | |
|--|-----------|---------|
| 20W Bright Cube Spot Beam LED Cube Light - 70 x 64mm (Each) - Clear | ILED20B | \$62.00 |
| 20W Bright Cube Spot Beam LED Cube Light - 70 x 64mm (Each) - Amber | ILED20BA | \$62.00 |
| 20W Bright Cube Flood Beam LED Cube Light - 70 x 64mm (Each) - Clear | ILED20BF | \$62.00 |
| 20W Bright Cube Flood Beam LED Cube Light - 70 x 64mm (Each) - Amber | ILED20BFA | \$62.00 |
| 20W Bright Cube Flood Beam LED Cube Light - 70 x 64mm (Each) - Red | ILED20BFR | \$62.00 |

PREMIUM UNDERBODY PROTECTION

| | | |
|-----------------------------|--------|----------|
| Engine Bay and Transmission | UBP073 | \$745.00 |
|-----------------------------|--------|----------|

SLIDE-AWAY ROLL UP HARD TONNEAU COVER

| | | |
|--|------------------|-----------|
| Electric with Remote Control (Long Bed) | ISLIDEAWAY073L-E | \$2821.00 |
| Electric with Remote Control (Short Bed) | ISLIDEAWAY073S-E | \$2716.00 |

ATLAS RACK KITS

| | | |
|--|---------------|-----------|
| Platform S with Blade Fit Kit to Suit Slideaway Hard Tonneau Cover - 1390mm Length | IFRSLDAWAYPSK | \$1670.00 |
| Crossbar (x 2) and Fit Kit to Suit Slideaway Hard Tonneau Cover - 1500mm Width | IFRSLDAWAYC2K | \$940.00 |

• See Page 36 and 37 for more Atlas rack and crossbar options.

BREATHER KIT

| | | |
|---|----------|----------|
| Universal Twin Manifold Filtered Breather Kit | IDIFFBRE | \$115.00 |
|---|----------|----------|



Toyota Tundra

2006 to 2021

Product Description

Part No.

Qty
ReqRetail
ea Inc GST*Please check vehicle date range (if shown) next to product description prior to ordering***SUSPENSION TO SUIT TOYOTA TUNDRA - 2006-2021****FRONT SUSPENSION****SHOCK ABSORBER**

| | | | | | |
|-----------------------------------|--|--|----------------|---|----------|
| Foam Cell Strut - Performance | | | 24780FE | 2 | \$291.00 |
| Foam Cell Pro Strut - Performance | | | 45780FE | 2 | \$406.00 |

- Foam Cell Pro - Must use TOY063B or TOY063C Front Coil Springs

COIL SPRINGS

| | Est. Lift | Additional Load | | | |
|--------|-----------|-----------------|----------------|---|----------|
| Medium | 60mm | 0 - 50kg | TOY070B | 1 | \$262.00 |
| Heavy | 60mm | 50 - 110kg | TOY070C | 1 | \$262.00 |

- Not compatible with Foam Cell Pro, refer note above

STRUT MOUNTS

| | | | | | |
|-----------------|--|--|----------------|---|---------|
| Steel Strut Top | | | ISST005 | 2 | \$88.00 |
|-----------------|--|--|----------------|---|---------|

TRIM PACKERS

| | | | | | |
|------------------------|-----------|--|-----------------|---|---------|
| 5mm Strut Trim Packer | Foam Cell | | HILFR05F | 2 | \$30.00 |
| 10mm Strut Trim Packer | Foam Cell | | HILFR10F | 2 | \$30.00 |
| 15mm Strut Trim Packer | Foam Cell | | HILFR15F | 2 | \$30.00 |

- ONLY Compatible with Ironman 4x4 Struts (except Pro), lift height subject to 2:1 motion ratio. Unnecessary fitment may lift vehicle too high

CONTROL ARMS

| | | | | | |
|------------------------------|--|--|-----------------|---|----------|
| Pro-Forge Upper Control Arms | | | UCA073FA | 1 | \$882.00 |
|------------------------------|--|--|-----------------|---|----------|

REAR SUSPENSION**SHOCK ABSORBER**

| | | | | | |
|-----------------------------|--|--|----------------|---|----------|
| Foam Cell - Performance | | | 24781FE | 2 | \$232.00 |
| Foam Cell Pro - Performance | | | 45781FE | 2 | \$319.00 |

LEAF SPRINGS

| | Est. Lift | Additional Load | | | |
|--------|-----------|-----------------|----------------|---|----------|
| Medium | 60mm | 0 - 200kg | TOY071B | 2 | \$522.00 |
| Heavy | 60mm | 200 - 400kg | TOY071C | 2 | \$537.00 |

U-BOLTS

| | | | | | |
|------------|--|--|---------------|---|---------|
| U-Bolt Kit | | | 678UBK | 2 | \$44.00 |
|------------|--|--|---------------|---|---------|

POLYURETHANE SPRING BUSHES

| | | | | | |
|----------|--|--|---------------|---|---------|
| Bush Kit | | | 1196UK | 1 | \$88.00 |
|----------|--|--|---------------|---|---------|

DRIVELINE SPACERS

| | | | | | |
|---------------------------|--|--|--------------|---|---------|
| Centre Bearing Spacer Kit | | | 1217K | 1 | \$30.00 |
|---------------------------|--|--|--------------|---|---------|

SPACER KIT

| | | | | | |
|---------------------------|--|--|--------------|---|---------|
| Brake Hose Relocation Kit | | | 1197K | 1 | \$44.00 |
|---------------------------|--|--|--------------|---|---------|

GREASABLE SHACKLES AND PINS

| | | | | | |
|-------------------|--|--|-------------|---|---------|
| Greasable Shackle | | | 1150 | 2 | \$44.00 |
|-------------------|--|--|-------------|---|---------|

HELPER SPRINGS

| | | | | | |
|--------------------------|--|--|------------|---|----------|
| Load Plus Helper Springs | | | LP3 | 1 | \$165.00 |
|--------------------------|--|--|------------|---|----------|

SUSPENSION KIT - Specify Front Coil Springs When Ordering

| | | | | | |
|------------------------|--|--|------------------|--|-----------|
| Medium - Foam Cell | | | TOY070BKF | | \$2563.00 |
| Medium - Foam Cell Pro | | | TOY070BKP | | \$2968.00 |
| Heavy - Foam Cell | | | TOY070CKF | | \$2592.00 |
| Heavy - Foam Cell Pro | | | TOY070CKP | | \$2998.00 |

SUSPENSION KIT CONTENTS

| | | | |
|-----------------|--------------|----------------------------|-----------------------|
| Shock Absorbers | Coil Springs | Polyurethane Spring Bushes | Strut Shock Absorbers |
| Leaf Springs | U-Bolts | Brake Hose Relocation Kit | |

Troller T4

7/2014+



Product Description

Part No.

Qty
Req

Retail
ea Inc GST

Please check vehicle date range (if shown) next to product description prior to ordering

SUSPENSION TO SUIT TROLLER T4 - 7/2014+

FRONT SUSPENSION

SHOCK ABSORBER

Nitro Gas - Performance

12755GR 2 \$149.00

COIL SPRINGS

Medium Est. Lift 50mm Additional Load 0 - 50kg

TROL001B 1 \$229.00

REAR SUSPENSION

SHOCK ABSORBER

Nitro Gas - Performance

12755GR 2 \$149.00

COIL SPRINGS

Medium Est. Lift 50mm Additional Load 0 - 200kg

TROL002B 1 \$229.00

SUSPENSION KIT

Medium - Nitro Gas

TROL001BKG \$1159.00

SUSPENSION KIT CONTENTS

Shock Absorbers

Coil Springs



1997 to 6/2014

Troller T4

Product Description

Part No.

Qty
Req

Retail
ea Inc GST

Please check vehicle date range (if shown) next to product description prior to ordering

SUSPENSION TO SUIT TROLLER T4 - 1997-6/2014

FRONT SUSPENSION

SHOCK ABSORBER

Nitro Gas - Performance

12765GR

2

\$149.00

COIL SPRINGS

Est. Lift

Additional Load

Medium

45mm

0 - 50kg

TROL003B

1

\$229.00

REAR SUSPENSION

SHOCK ABSORBER

Nitro Gas - Performance

12765GR

2

\$149.00

COIL SPRINGS

Est. Lift

Additional Load

Medium

45mm

0 -200kg

TROL004B

1

\$229.00

SUSPENSION KIT

Medium - Nitro Gas

TROL003BKG

\$1159.00

SUSPENSION KIT CONTENTS

Shock Absorbers

Coil Springs





Product Description

Part No.

Qty
Req

Retail
ea Inc GST

Please check vehicle date range (if shown) next to product description prior to ordering

SUSPENSION TO SUIT UAZ HUNTER

FRONT SUSPENSION

SHOCK ABSORBER

| | | | | | |
|-------------------------|--|--|----------------|---|----------|
| Nitro Gas - Performance | | | 12652GR | 2 | \$160.00 |
| Foam Cell - Performance | | | 24652FE | 2 | \$232.00 |

COIL SPRINGS

| | | | | | |
|--------|-------------------|-----------------------------|-----------------|---|----------|
| Medium | Est. Lift 45mm | Additional Load 0 - 80kg | IMAZ001B | 1 | \$242.00 |
|--------|-------------------|-----------------------------|-----------------|---|----------|

REAR SUSPENSION

SHOCK ABSORBER

| | | | | | |
|-------------------------|--|--|----------------|---|----------|
| Nitro Gas - Performance | | | 12698GR | 2 | \$160.00 |
| Foam Cell - Performance | | | 24698FE | 2 | \$232.00 |

LEAF SPRINGS

| | | | | | |
|--------|-------------------|------------------------------|-----------------|---|----------|
| Medium | Est. Lift 45mm | Additional Load 0 - 300kg | IMAZ002B | 2 | \$309.00 |
|--------|-------------------|------------------------------|-----------------|---|----------|

U-BOLTS

| | | | | | |
|------------|--|--|---------------|---|---------|
| U-Bolt Kit | | | 678UBK | 2 | \$44.00 |
|------------|--|--|---------------|---|---------|

POLYURETHANE SPRING BUSHES

| | | | | | |
|----------|--|--|---------------|---|---------|
| Bush Kit | | | 1188UK | 1 | \$88.00 |
|----------|--|--|---------------|---|---------|

GREASABLE SHACKLES AND PINS

| | | | | | |
|-------------------|--|--|-------------|---|---------|
| Greasable Shackle | | | 1189 | 2 | \$74.00 |
|-------------------|--|--|-------------|---|---------|

SUSPENSION KIT

| | | | | | |
|--------------------|--|--|-------------------|--|-----------|
| Medium - Nitro Gas | | | IMAZ001BKG | | \$2288.00 |
| Medium - Foam Cell | | | IMAZ001BKF | | \$2577.00 |

SUSPENSION KIT CONTENTS

| | | |
|-----------------|--------------|----------------------------|
| Shock Absorbers | Coil Springs | Polyurethane Spring Bushes |
| Leaf Springs | U-Bolts | Shackles |

UAZ Patriot



1997+

Product Description

Part No.

Qty
Req

Retail
ea Inc GST

Please check vehicle date range (if shown) next to product description prior to ordering

SUSPENSION TO SUIT UAZ PATRIOT - 1997+

FRONT SUSPENSION

SHOCK ABSORBER

| | | | | | |
|-------------------------|--|--|-----------------|---|----------|
| Nitro Gas - Performance | | | 12637GRS | 2 | \$160.00 |
| Foam Cell - Performance | | | 24637FES | 2 | \$232.00 |

COIL SPRINGS

| | Est. Lift | Additional Load | | | |
|--------|-----------|-----------------|-----------------|---|----------|
| Medium | 45mm | 0 - 80kg | IMAZ001B | 1 | \$242.00 |

REAR SUSPENSION

SHOCK ABSORBER

| | | | | | |
|-------------------------|--|--|----------------|---|----------|
| Nitro Gas - Performance | | | 12698GR | 2 | \$160.00 |
| Foam Cell - Performance | | | 24698FE | 2 | \$232.00 |

LEAF SPRINGS

| | Est. Lift | Additional Load | | | |
|--------|-----------|-----------------|-----------------|---|----------|
| Medium | 45mm | 0 - 300kg | IMAZ002B | 2 | \$309.00 |

U-BOLTS

| | | | | | |
|------------|--|--|---------------|---|---------|
| U-Bolt Kit | | | 678UBK | 2 | \$44.00 |
|------------|--|--|---------------|---|---------|

POLYURETHANE SPRING BUSHES

| | | | | | |
|----------|--|--|---------------|---|---------|
| Bush Kit | | | 1188UK | 1 | \$88.00 |
|----------|--|--|---------------|---|---------|

GREASABLE SHACKLES AND PINS

| | | | | | |
|-------------------|--|--|-------------|---|---------|
| Greasable Shackle | | | 1189 | 2 | \$74.00 |
|-------------------|--|--|-------------|---|---------|

SUSPENSION KIT

| | | | | | |
|--------------------|--|--|--------------------|--|-----------|
| Medium - Nitro Gas | | | IMAZ001BKG1 | | \$2288.00 |
| Medium - Foam Cell | | | IMAZ001BKF1 | | \$2577.00 |

SUSPENSION KIT CONTENTS

| | | |
|-----------------|--------------|----------------------------|
| Shock Absorbers | Coil Springs | Polyurethane Spring Bushes |
| Leaf Springs | U-Bolts | Greasable Shackles |



Product Description

Part No.

Qty
ReqRetail
ea Inc GST

Please check vehicle date range (if shown) next to product description prior to ordering

ACCESSORIES TO SUIT VOLKSWAGEN AMAROK - 11/2016+

STEEL WINCH BULL BARS

| | | |
|-------------------------------------|-----------|-----------|
| Commercial Deluxe | BBCD060 | \$2387.00 |
| Proguard No Loop | BBT060-NL | \$1973.00 |
| Proguard Single Loop Kit | BB060-SL | \$352.00 |
| Proguard Triple Loop Kit | BB060-TL | \$423.00 |
| Driving Light / Lightbar Patch Loom | IPL060 | \$33.00 |

• Can also be fitted to both 2WD and 4WD models.

STEEL SIDE STEPS AND RAILS

| | | |
|----------------------|------------|-----------|
| Side Steps | SS034 | \$1006.00 |
| Side Rails | SS034 RAIL | \$332.00 |
| Side Steps and Rails | SSR034 | \$1207.00 |

TOWING

| | | |
|--|---------|-----------|
| Rear Protection Towbar - Full Rear Bumper Replacement (11/2016 to 2020 only) | RTB060 | \$1388.00 |
| Towbar Wiring Loom - Plug and Play | ITBL060 | \$466.00 |

LOCKSAFE DRAWER SYSTEMS

| | | |
|------------------------|---------|-----------|
| Twin Drawers - 1300mm | ITD1300 | \$1536.00 |
| Single Drawer - 1300mm | ISD1300 | \$932.00 |
| Wing Kit - 1300mm | ITDW060 | \$367.00 |

SNORKEL

| | | |
|--------|-------------|----------|
| Amarok | ISNORKELO37 | \$437.00 |
|--------|-------------|----------|

CANOPY - ABS PLASTIC (SIDE LIFT UP WINDOWS) - FITS 4X4 AND 4X2 DUAL CAB MODELS

| | | |
|--------------------|-------------|-----------|
| Pre-Primed | CANOPY021-P | \$3238.00 |
| Candy White (B4B4) | CANOPY021-W | \$3856.00 |

CANOPY - PINNACLE 2 SMOOTH FINISH FIBREGLASS (SIDE LIFT UP WINDOWS AND CENTRAL LOCKING REAR DOOR) - FITS 4X4 AND 4X2 DUAL CAB MODELS

| | | |
|--------------------|--------------|-----------|
| Pre-Primed | ICANOPY060-P | \$3213.00 |
| Candy White (B4B4) | ICANOPY060-W | \$3763.00 |

* Pre-primed canopies, plus colour coding.

SLIDE-AWAY ROLL UP HARD TONNEAU COVER

| | | |
|------------------------------|-------------------|-----------|
| Electric with Remote Control | ISLIDEAWAY060-E | \$2716.00 |
| Sports Bar Adaptor | ISLIDEAWAY060-SBA | \$135.00 |

ATLAS DUAL CAB ROOF RACK KITS

| | | |
|--|---------------|-----------|
| Platform K with Leg Fit Kit to Suit Pinnacle 2 Canopy - 1390mm Length | IFRP2PKK | \$1294.00 |
| Crossbar (x 2) and Fit Kit to Suit Pinnacle 2 Canopy - 1250mm Width | IFRP2C125K | \$564.00 |
| Platform S with Blade Fit Kit to Suit Slideaway Hard Tonneau Cover - 1390mm Length | IFRSLDAWAYPSK | \$1670.00 |
| Crossbar (x 2) and Fit Kit to Suit Slideaway Hard Tonneau Cover - 1500mm Width | IFRSLDAWAYC2K | \$940.00 |

• See Page 36 and 37 for more Atlas rack and crossbar options.

SEAT COVER

| | | |
|------------------------|----------|----------|
| Canvas Comfort - Front | ICSC060F | \$420.00 |
| Canvas Comfort - Rear | ICSC060R | \$420.00 |

BREATHER KIT

| | | |
|---|----------|----------|
| Universal Twin Manifold Filtered Breather Kit | IDIFFBRE | \$115.00 |
|---|----------|----------|



V6 / 4 Cylinder
11/2016+

Volkswagen Amarok

Product Description

Part No.

Qty
ReqRetail
ea Inc GST

Please check vehicle date range (if shown) next to product description prior to ordering

SUSPENSION TO SUIT VOLKSWAGEN AMAROK - 11/2016+

FRONT SUSPENSION

SHOCK ABSORBER

| | | | | | |
|-------------------------------|--|--|----------------|---|----------|
| Nitro Gas Strut - Performance | | | 12725GR | 2 | \$232.00 |
|-------------------------------|--|--|----------------|---|----------|

COIL SPRINGS

| | Est. Lift | Additional Load | | | |
|---------------|-----------|-----------------|------------------|---|----------|
| Medium - 4cyl | 30mm | 0 - 50kg | VOLKS001B | 1 | \$262.00 |
| Heavy - V6 | 30mm | 50 - 110kg | VOLKS001C | 1 | \$262.00 |
| Heavy - V6 | 30mm | 50 - 110kg | VOLKS001D | 1 | \$262.00 |

TRIM PACKERS

| | | | | | |
|------------------------|--|-----------|----------------|---|---------|
| 5mm Strut Trim Packer | | Nitro Gas | HILFR05 | 2 | \$30.00 |
| 10mm Strut Trim Packer | | Nitro Gas | HILFR10 | 2 | \$30.00 |
| 15mm Strut Trim Packer | | Nitro Gas | HILFR15 | 2 | \$30.00 |

• ONLY Compatible with Ironman 4x4 Struts, lift height subject to 2:1 motion ratio. Unnecessary fitment may lift vehicle too high

REAR SUSPENSION

SHOCK ABSORBER

| | | | | | |
|-------------------------|--|--|----------------|---|----------|
| Nitro Gas - Performance | | | 12726GR | 2 | \$160.00 |
|-------------------------|--|--|----------------|---|----------|

LEAF SPRINGS

| | Est. Lift | Additional Load | | | |
|--------|-----------|-----------------|------------------|---|----------|
| Medium | 35mm | 0 - 300kg | VOLKS002B | 2 | \$392.00 |
| Heavy | 35mm | 200 - 400kg | VOLKS002C | 2 | \$421.00 |

U-BOLTS

| | | | | | |
|------------|--|--|---------------|---|---------|
| U-Bolt Kit | | | 415UBK | 2 | \$44.00 |
|------------|--|--|---------------|---|---------|

POLYURETHANE SPRING BUSHES

| | | | | | |
|----------|--|---------------------|---------------|---|---------|
| Bush Kit | | 32mm Shackle Bushes | 1190UK | 1 | \$88.00 |
|----------|--|---------------------|---------------|---|---------|

HELPER SPRINGS

| | | | | | |
|--------------------------|--|--|------------|---|----------|
| Load Plus Helper Springs | | | LP4 | 1 | \$165.00 |
|--------------------------|--|--|------------|---|----------|

SUSPENSION KIT - Specify Front Coil Springs When Ordering

| | | |
|--------------------|--------------------|-----------|
| Medium - Nitro Gas | VOLKS001BKG | \$1999.00 |
| Heavy - Nitro Gas | VOLKS001CKG | \$2056.00 |

SUSPENSION KIT CONTENTS

Shock Absorbers
Leaf Springs

Coil Springs
U-Bolts

Polyurethane Spring Bushes
Strut Shock Absorbers



Product Description

Part No.

Qty
ReqRetail
ea Inc GST

Please check vehicle date range (if shown) next to product description prior to ordering

ACCESSORIES TO SUIT VOLKSWAGEN AMAROK - 2011-10/2016

STEEL WINCH BULL BARS

| | | |
|--------------------------------------|---------|-----------|
| Commercial Deluxe | BBCD034 | \$2387.00 |
| Protector - <i>While Stocks Last</i> | BBT034 | \$2271.00 |
| Driving Light / Lightbar Patch Loom | IPL060 | \$33.00 |

• Can also be fitted to both 2WD and 4WD models.

STEEL SIDE STEPS AND RAILS

| | | |
|----------------------|------------|-----------|
| Side Steps | SS034 | \$1006.00 |
| Side Rails | SS034 RAIL | \$332.00 |
| Side Steps and Rails | SSR034 | \$1207.00 |

LOCKSAFE DRAWER SYSTEMS

| | | |
|------------------------|---------|-----------|
| Twin Drawers - 1300mm | ITD1300 | \$1536.00 |
| Single Drawer - 1300mm | ISD1300 | \$932.00 |
| Wing Kit - 1300mm* | ITDW040 | \$367.00 |

*Designed to suit factory tubs, will not suit ute liner without modification.

SNORKEL

| | | |
|--------|-------------|----------|
| Amarok | ISNORKEL037 | \$437.00 |
|--------|-------------|----------|

CANOPY - ABS PLASTIC (SIDE LIFT UP WINDOWS) - FITS 4X4 AND 4X2 DUAL CAB MODELS

| | | |
|--------------------|-------------|-----------|
| Pre-Primed | CANOPY021-P | \$3238.00 |
| Candy White (B4B4) | CANOPY021-W | \$3856.00 |
| Black (2T2) | CANOPY021-B | \$3856.00 |

CANOPY - PINNACLE 2 SMOOTH FINISH FIBREGLASS (SIDE LIFT UP WINDOWS AND CENTRAL LOCKING REAR DOOR) - FITS 4X4 AND 4X2 DUAL CAB MODELS

| | | |
|--------------------|--------------|-----------|
| Pre-Primed | ICANOPY060-P | \$3213.00 |
| Candy White (B4B4) | ICANOPY060-W | \$3763.00 |

* Pre-primed canopies, plus colour coding.

SLIDE-AWAY ROLL UP HARD TONNEAU COVER

| | | |
|------------------------------|-------------------|-----------|
| Electric with Remote Control | ISLIDEAWAY060-E | \$2716.00 |
| Sports Bar Adaptor | ISLIDEAWAY060-SBA | \$135.00 |

ATLAS DUAL CAB ROOF RACK KITS

| | | |
|--|---------------|-----------|
| Platform K with Leg Fit Kit to Suit Pinnacle 2 Canopy - 1390mm Length | IFRP2PKK | \$1294.00 |
| Crossbar (x 2) and Fit Kit to Suit Pinnacle 2 Canopy - 1250mm Width | IFRP2C125K | \$564.00 |
| Platform S with Blade Fit Kit to Suit Slideaway Hard Tonneau Cover - 1390mm Length | IFRSLDAWAYPSK | \$1670.00 |
| Crossbar (x 2) and Fit Kit to Suit Slideaway Hard Tonneau Cover - 1500mm Width | IFRSLDAWAYC2K | \$940.00 |

• See Page 36 and 37 for more Atlas rack and crossbar options.

SEAT COVER

| | | |
|------------------------|----------|----------|
| Canvas Comfort - Front | ICSC060F | \$420.00 |
| Canvas Comfort - Rear | ICSC060R | \$420.00 |

BREATHER KIT

| | | |
|---|----------|----------|
| Universal Twin Manifold Filtered Breather Kit | IDIFFBRE | \$115.00 |
|---|----------|----------|



1997 to 10/2016

Volkswagen Amarok

Product Description

Part No.

Qty
ReqRetail
ea Inc GST

Please check vehicle date range (if shown) next to product description prior to ordering

SUSPENSION TO SUIT VOLKSWAGEN AMAROK - 1997-10/2016

FRONT SUSPENSION

SHOCK ABSORBER

| | | | | | |
|-------------------------------|--|--|----------------|---|----------|
| Nitro Gas Strut - Performance | | | 12725GR | 2 | \$232.00 |
|-------------------------------|--|--|----------------|---|----------|

COIL SPRINGS

| | Est. Lift | Additional Load | | | |
|---------------|-----------|-----------------|------------------|---|----------|
| Medium - 4cyl | 30mm | 0 - 50kg | VOLKS001B | 1 | \$262.00 |
| Heavy - V6 | 30mm | 50 - 110kg | VOLKS001C | 1 | \$262.00 |
| Heavy - V6 | 30mm | 50 - 110kg | VOLKS001D | 1 | \$262.00 |

TRIM PACKERS

| | | | | | |
|------------------------|--|-----------|----------------|---|---------|
| 5mm Strut Trim Packer | | Nitro Gas | HILFR05 | 2 | \$30.00 |
| 10mm Strut Trim Packer | | Nitro Gas | HILFR10 | 2 | \$30.00 |
| 15mm Strut Trim Packer | | Nitro Gas | HILFR15 | 2 | \$30.00 |

• ONLY Compatible with Ironman 4x4 Struts, lift height subject to 2:1 motion ratio. Unnecessary fitment may lift vehicle too high

REAR SUSPENSION

SHOCK ABSORBER

| | | | | | |
|-------------------------|--|--|----------------|---|----------|
| Nitro Gas - Performance | | | 12726GR | 2 | \$160.00 |
|-------------------------|--|--|----------------|---|----------|

LEAF SPRINGS

| | Est. Lift | Additional Load | | | |
|--------|-----------|-----------------|------------------|---|----------|
| Medium | 35mm | 0 - 300kg | VOLKS002B | 2 | \$392.00 |
| Heavy | 35mm | 200 - 400kg | VOLKS002C | 2 | \$421.00 |

U-BOLTS

| | | | | | |
|------------|--|--|---------------|---|---------|
| U-Bolt Kit | | | 415UBK | 2 | \$44.00 |
|------------|--|--|---------------|---|---------|

POLYURETHANE SPRING BUSHES

| | | | | | |
|----------|--|----------------------|---------------|---|---------|
| Bush Kit | | 32mm Shackles Bushes | 1190UK | 1 | \$88.00 |
|----------|--|----------------------|---------------|---|---------|

HELPER SPRINGS

| | | | | | |
|--------------------------|--|--|------------|---|----------|
| Load Plus Helper Springs | | | LP4 | 1 | \$165.00 |
|--------------------------|--|--|------------|---|----------|

SUSPENSION KIT - Specify Front Coil Springs When Ordering

| | | |
|--------------------|--------------------|-----------|
| Medium - Nitro Gas | VOLKS001BKG | \$1999.00 |
| Heavy - Nitro Gas | VOLKS001CKG | \$2056.00 |

SUSPENSION KIT CONTENTS

Shock Absorbers
Leaf Springs

Coil Springs
U-Bolts

Polyurethane Spring Bushes
Strut Shock Absorbers

Spare Parts

CATALOGUE AND PRICE LIST

Effective 1 December 2022



Spare Parts

| Product Description | Part No. | Retail ea Inc GST |
|--|---------------|----------------------|
| BULL BARS | | |
| Bullbar Indicator - LED Park/Indicator/DRL (Pair) | BBPART002 | \$173.00 |
| 1m Pinch Weld for Bumper Cut | BBPART006 | \$6.00 |
| Bull Bar Fog Light - Halogen (Pair) | BBPART008 | \$128.00 |
| Plastic Light Pod and Bracket - Old Style Triangle Unit (Each) | BBPART009 | - |
| Plastic Light Pod Surround L/H | BBPART009 L/H | \$45.00 |
| Plastic Light Pod Surround R/H | BBPART009 R/H | \$45.00 |
| Wiring Loom - New Style | BBPART012 | \$56.00 |
| Plastic Inserts to suit Hilux Vigo BB002 (Pair) | BBPART013 | \$16.00 |
| Ironman 4x4 Bull Bar Logo Badge | BBPART014 | \$5.00 |
| Ironman 4x4 Logo Resin Style SS/ SSR Rails | BBPART019 | \$4.00 |
| Washer Bottle to Suit BBC050/ BBCD050/ BBT050 | BBPART021 | \$40.00 |
| Plastic Light Pod Insert L/H (Single) | BBPART022-LH | \$45.00 |
| Plastic Light Pod Insert R/H (Single) | BBPART022-RH | \$45.00 |
| Bull Bar Loop O-Ring Kit | BBPART023 | \$10.00 |
| Bumper Override for BBT - New Style (Pair) | BBPART010 | \$79.00 |
| Bumper Override for BBC (Pair) | BBPART011 | \$79.00 |
| Bumper Override for BBC/ BBCD033 to BBC/ BBCD049 | BBPART015 | \$79.00 |
| Bumper Override for BBCD035 | BBPART020 | \$79.00 |
| Bumper Override For BBC051/ BBCD051 onwards | BBPART024 | \$79.00 |
| Bumper Override for BBT051 onwards | BBPART025 | \$79.00 |
| Licence Plate Bracket | BBPART026 | \$23.00 |
| Bull Bar LED Fog Light (Pair) | BBPART031 | \$114.00 |
| Polyurethane Override Kit to Suit BBR110 Raid Bar | BBPART046 | \$89.00 |
| Numberplate Flip Bracket - Bar Mount | BBPART052 | \$55.00 |
| Numberplate Flip Bracket - Fairlead Mount | BBPART053 | \$65.00 |
| Bolt on Hoop to suit BBR077 | BBPART054 | \$165.00 |
| Load Resistor Kit with Mount Brackets for 12V/21W Indicator/Parker Replacement | LR12V21W | \$52.00 |
| Load Resistor Kit with Mount Brackets for 12V/50W Indicator/Parker Replacement | LR12V50W | \$68.00 |
| Universal Parking Sensor Holder to Suit Raid Bars (Lock Nut Style) | RAPIDPSHUNI | \$48.00 |
| Triple Stainless Steel Loop for BBT001 | BBPARTLOOP001 | \$333.00 |
| Triple Stainless Steel Loop for BBT002 | BBPARTLOOP002 | \$333.00 |
| Triple Stainless Steel Loop for BBT003 | BBPARTLOOP003 | \$333.00 |
| Triple Stainless Steel Loop for BBT004 | BBPARTLOOP004 | \$333.00 |
| Triple Stainless Steel Loop for BBT005/ 006 | BBPARTLOOP005 | \$333.00 |
| Triple Stainless Steel Loop for BBT007 | BBPARTLOOP007 | \$333.00 |
| Triple Stainless Steel Loop for BBT008 | BBPARTLOOP008 | \$333.00 |
| Triple Stainless Steel Loop for BBT009 | BBPARTLOOP009 | \$333.00 |
| Triple Stainless Steel Loop for BBT010 | BBPARTLOOP010 | \$333.00 |
| Triple Stainless Steel Loop for BBT011 | BBPARTLOOP011 | \$333.00 |
| Triple Stainless Steel Loop for BBT012 | BBPARTLOOP012 | \$333.00 |
| Triple Stainless Steel Loop for BBT013 | BBPARTLOOP013 | \$333.00 |
| Triple Stainless Steel Loop for BBT014 | BBPARTLOOP014 | \$333.00 |
| Triple Stainless Steel Loop for BBT016 | BBPARTLOOP016 | \$333.00 |
| Triple Stainless Steel Loop for BBT019 | BBPARTLOOP019 | \$333.00 |
| Triple Stainless Steel Loop for BBT020 | BBPARTLOOP020 | \$333.00 |
| Triple Stainless Steel Loop for BBT024 | BBPARTLOOP024 | \$333.00 |
| Triple Stainless Steel Loop for BBT025 | BBPARTLOOP025 | \$333.00 |
| Triple Stainless Steel Loop for BBT027 | BBPARTLOOP027 | \$333.00 |
| Triple Stainless Steel Loop for BBT029 | BBPARTLOOP029 | \$333.00 |
| Triple Stainless Steel Loop for BBT031 | BBPARTLOOP031 | \$333.00 |
| Triple Stainless Steel Loop for BBT033 | BBPARTLOOP033 | \$333.00 |
| Triple Stainless Steel Loop for BBT034 | BBPARTLOOP034 | \$333.00 |
| Triple Stainless Steel Loop for BBT037 | BBPARTLOOP037 | \$333.00 |
| Triple Stainless Steel Loop for BBT038 | BBPARTLOOP038 | \$333.00 |
| Triple Stainless Steel Loop for BBT039 | BBPARTLOOP039 | \$333.00 |
| Triple Stainless Steel Loop for BBT040 | BBPARTLOOP040 | \$333.00 |
| Triple Stainless Steel Loop for BBT041 | BBPARTLOOP041 | \$333.00 |
| Triple Stainless Steel Loop for BBT042 | BBPARTLOOP042 | \$333.00 |



Spare Parts

| Product Description | Part No. | Retail ea Inc GST |
|---|---------------|----------------------|
| Triple Stainless Steel Loop for BBT043 | BBPARTLOOP043 | \$333.00 |
| Triple Stainless Steel Loop for BBT044 | BBPARTLOOP044 | \$333.00 |
| Triple Stainless Steel Loop for BBT045 | BBPARTLOOP045 | \$333.00 |
| Triple Stainless Steel Loop for BBT047 | BBPARTLOOP047 | \$333.00 |
| Triple Stainless Steel Loop for BBT048 | BBPARTLOOP048 | \$333.00 |
| Triple Stainless Steel Loop for BBT049 | BBPARTLOOP049 | \$333.00 |
| Triple Stainless Steel Loop for BBT050 | BBPARTLOOP050 | \$333.00 |
| Triple Stainless Steel Loop for BBT051 | BBPARTLOOP051 | \$333.00 |
| Triple Stainless Steel Loop for BBT054 | BBPARTLOOP054 | \$333.00 |
| Triple Stainless Steel Loop for BBT056/ 056xv | BBPARTLOOP056 | \$333.00 |
| Triple Stainless Steel Loop for BBT057 | BBPARTLOOP057 | \$333.00 |
| Triple Stainless Steel Loop for BBT058 | BBPARTLOOP058 | \$333.00 |

CANOPIES

| | | |
|--|----------------------|----------|
| Mount Kit for CANOPY014 | CANOPY MOUNT KIT 014 | \$171.00 |
| Mount Kit for CANOPY015 | CANOPY MOUNT KIT 015 | \$171.00 |
| Rear Door Handle and Key Set (For Non Central Locking Models) | CANOPYSPARE001 | \$169.00 |
| Rear Window Gas Strut CANOPY001/ 002/ 005/ 006/ 007 (Pair) | CANOPYSPARE002 | \$106.00 |
| Rear Window Gas Strut for CANOPY003/ 004 (Pair) | CANOPYSPARE003 | \$135.00 |
| Plate Side Lock Set All Models to CANOPY008 (Striker) | CANOPYSPARE004 | \$42.00 |
| Canopy Internal Light (All Models) | CANOPYSPARE005 | \$39.00 |
| Rubber Seal Kit Suits All to CANOPY007 | CANOPYSPARE006 | \$31.00 |
| Rubber Seal Kit CANOPY008 to CANOPY011 | CANOPYSPARE007 | \$44.00 |
| Rear Window Bolt Set for CANOPY003/ 004 | CANOPYSPARE008 | \$53.00 |
| Edge Seal Kit for CANOPY006 | CANOPYSPARE009 | \$60.00 |
| Edge Seal Kit for CANOPY005 | CANOPYSPARE010 | \$60.00 |
| Edge Seal Kit for CANOPY001/ 002 | CANOPYSPARE012 | \$30.00 |
| Replacement LED Brakelight (All Models) | CANOPYSPARE013 | \$41.00 |
| Sliding Window L/H for CANOPY001/ 002/ 005/ 006/ 007/ 009 | CANOPYSPARE014 | \$487.00 |
| Sliding Window L/H for CANOPY003/ 004 | CANOPYSPARE015 | \$504.00 |
| Sliding Window R/H for CANOPY003/ 004 | CANOPYSPARE016 | \$471.00 |
| Sliding Window R/H for CANOPY001/ 002/ 005/ 006/ 007/ 009 | CANOPYSPARE017 | \$489.00 |
| Rear Glass Rod Set for CANOPY001 to CANOPY007 and CANOPY009 | CANOPYSPARE018 | \$41.00 |
| Rear Side Plate Lock Set for CANOPY010 | CANOPYSPARE019 | \$33.00 |
| Rear Side Plate Lock Set for CANOPY009/ 011 | CANOPYSPARE020 | \$35.00 |
| Sliding Window R/H for CANOPY008/ 010/ 011/ 012 | CANOPYSPARE021 | \$487.00 |
| Sliding Window L/H for CANOPY008/ 010/ 011/ 012 | CANOPYSPARE022 | \$487.00 |
| Rear Window Gas Strut for CANOPY011 (Pair) | CANOPYSPARE023 | \$129.00 |
| Rear Window Bolt Set for CANOPY001/ 002/ 005/ 006/ 007 | CANOPYSPARE024 | \$7.00 |
| Rotary Lock for CANOPY008 | CANOPYSPARE025 | \$62.00 |
| Rear Window Hinge Set for CANOPY001/ 002/ 005/ 006/ 007/ 009 | CANOPYSPARE026 | \$189.00 |
| Rear Window Hinge Set for CANOPY008 | CANOPYSPARE027 | \$167.00 |
| Rear Window Hinge Set for CANOPY010 | CANOPYSPARE028 | \$201.00 |
| Rear Window Hinge Set for CANOPY011 | CANOPYSPARE029 | \$168.00 |
| Rear Window Bolt Set Upper for CANOPY010 | CANOPYSPARE031 | \$12.00 |
| Front Sliding Window for CANOPY001/ 005/ 006/ 007/ 008/ 010/ 014 | CANOPYSPARE032 | \$356.00 |
| Rear Window Gas Strut for CANOPY010 (Pair) | CANOPYSPARE033 | \$132.00 |
| Rear Window Gas Strut for CANOPY008 (Pair) | CANOPYSPARE034 | \$133.00 |
| Rotary Lock Set for CANOPY010/ 011/ 012 | CANOPYSPARE035 | \$72.00 |
| Mount Kit for CANOPY001 | CANOPYSPARE036 | \$167.00 |
| Mount Kit for CANOPY002 | CANOPYSPARE037 | \$167.00 |
| Mount Kit for CANOPY003 | CANOPYSPARE038 | \$167.00 |
| Mount Kit for CANOPY004 | CANOPYSPARE039 | \$167.00 |
| Mount Kit for CANOPY005 | CANOPYSPARE040 | \$173.00 |
| Mount Kit for CANOPY006 | CANOPYSPARE041 | \$173.00 |
| Mount Kit for CANOPY007 | CANOPYSPARE042 | \$173.00 |
| Mount Kit for CANOPY008 | CANOPYSPARE043 | \$167.00 |
| Mount Kit for CANOPY009 | CANOPYSPARE044 | \$267.00 |
| Mount Kit for CANOPY010 | CANOPYSPARE045 | \$273.00 |
| Mount Kit for CANOPY011 | CANOPYSPARE046 | \$167.00 |



Spare Parts

Product Description

Part No.

Retail
ea Inc GST**CANOPIES - CONTINUED**

| | | |
|--|---------------------|----------|
| Mount Kit for CANOPY012 | CANOPYSPARE047 | \$287.00 |
| Side Lift Up Window L/H for CANOPY001/ 002/ 005/ 006/ 007/ 009 | CANOPYSPARE048 | \$743.00 |
| Side Lift Up Window R/H for CANOPY001/ 002/ 005/ 006/ 007/ 009 | CANOPYSPARE049 | \$743.00 |
| Side Lift Up Window L/H for CANOPY003/ 004 | CANOPYSPARE050 | \$747.00 |
| Side Lift Up Window R/H for CANOPY003/ 004 | CANOPYSPARE051 | \$747.00 |
| Side Lift Up Window L/H for CANOPY008/ 010/ 011/ 012 | CANOPYSPARE052 | \$747.00 |
| Side Lift Up Window R/H for CANOPY008/ 010/ 011/ 012 | CANOPYSPARE053 | \$747.00 |
| Rubber Window Seal Kit for CANOPY001/ 002/ 003/ 004 | CANOPYSPARE054 | \$60.00 |
| Window Rubber Seal Kit for CANOPY008 | CANOPYSPARE055 | \$55.00 |
| Mounting Kit Seal for CANOPY010 | CANOPYSPARE056 | \$60.00 |
| Window Rubber Seal Kit for CANOPY011 | CANOPYSPARE057 | \$55.00 |
| Rear Window Bolt Set Lower Series 1 | CANOPYSPARE058 | \$9.00 |
| Rear Window Bolt Set Lower for CANOPY010 | CANOPYSPARE059 | \$12.00 |
| Ironman 4x4 Resin Logo Small | CANOPYSPARE060 | \$21.00 |
| Side Lift Up Window Handle for Series 1/ 2 (Set of 4) | CANOPYSPARE061 | \$96.00 |
| Side lift Up Window Handle for Series 3 (Set of 4) | CANOPYSPARE062 | \$96.00 |
| Rear Window Gas Strut for CANOPY009 (Pair) | CANOPYSPARE063 | \$133.00 |
| Front Sliding Window for CANOPY011/ 012 | CANOPYSPARE064 | \$411.00 |
| Rear Window Lock and Key Set for CANOPY014/ 015 | CANOPYSPARE066 | \$135.00 |
| Side Lift Up Window L/H for CANOPY014 | CANOPYSPARE068 | \$654.00 |
| Side Lift Up Window R/H for CANOPY014 | CANOPYSPARE069 | \$747.00 |
| Internal Light - Battery Operated | CANOPYSPARE070 | \$57.00 |
| Sliding Window L/H for CANOPY019/ 020 | CANOPYSPARE071 | \$487.00 |
| Sliding Window R/H for CANOPY019/ 020 | CANOPYSPARE072 | \$487.00 |
| Lift Up Window L/H for CANOPY019/ 020 | CANOPYSPARE073 | \$800.00 |
| Lift Up Window R/H for CANOPY019/ 020 | CANOPYSPARE074 | \$800.00 |
| Rear Door Key Set - Central Locking | CANOPYSPARE075 | \$169.00 |
| Rear Window Gas Strut for CANOPY014/ 015 (Pair) | CANOPYSPARE076 | \$90.00 |
| Side Lock Set for CANOPY014/ 015 | CANOPYSPARE077 | \$41.00 |
| Rear Window Seal for CANOPY014/ 015/ 019/ 020 | CANOPYSPARE078 | \$44.00 |
| Central Locking Solenoid | CANOPYSPARE079 | \$61.00 |
| Side Lift Up Window L/H for CANOPY013/ 015 | CANOPYSPARE080 | \$862.00 |
| Side Lift Up Window R/H for CANOPY013/ 015 | CANOPYSPARE081 | \$862.00 |
| Sliding Window L/H for CANOPY013/ 015/ 017 | CANOPYSPARE082 | \$525.00 |
| Sliding Window R/H for CANOPY013/ 015/ 017 | CANOPYSPARE083 | \$525.00 |
| Rubber Window Seal for Side Windows S3 | CANOPYSPARE084 | \$61.00 |
| Rear Window Gas Strut for CANOPY012/ 019 (Pair) | CANOPYSPARE085 | \$68.00 |
| Rear Window Gas Strut for CANOPY013/ 017/ 018 (Pair) | CANOPYSPARE086 | \$68.00 |
| Rear Side Lock Catches for CANOPY019/ 020 (Pair) | CANOPYSPARE087 | \$75.00 |
| Sliding Window L/H for CANOPY022 | CANOPYSPARE088 | \$294.00 |
| Sliding Window R/H for CANOPY022 | CANOPYSPARE089 | \$294.00 |
| Side Lift Up Window L/H for CANOPY022 | CANOPYSPARE090 | \$690.00 |
| Side Lift Up Window R/H for CANOPY022 | CANOPYSPARE091 | \$690.00 |
| Rear Window for CANOPY003 | CANOPY003-WINDOW | \$657.00 |
| Rear Window for CANOPY004 | CANOPY004-WINDOW | \$608.00 |
| Rear Window for CANOPY005 | CANOPY005-WINDOW | \$600.00 |
| Rear Window for CANOPY006 | CANOPY006-WINDOW | \$600.00 |
| Rear Window for CANOPY007 | CANOPY007-WINDOW | \$506.00 |
| Rear Window for CANOPY008 | CANOPY008-WINDOW | \$471.00 |
| Rear Window for CANOPY009 | CANOPY009-WINDOW | \$757.00 |
| Rear Window for CANOPY010 | CANOPY010-WINDOW | \$751.00 |
| Rear Window Assy for CANOPY010 - Central Locking | CANOPY010-CL WINDOW | \$754.00 |
| Rear Window for CANOPY011 | CANOPY011-WINDOW | \$693.00 |
| Rear Window for CANOPY012 | CANOPY012-WINDOW | \$714.00 |
| Rear Window Assy for CANOPY014 | CANOPY014-WINDOW | \$687.00 |
| Rear Window Assy for CANOPY014 - Central Locking | CANOPY014-CL WINDOW | \$736.00 |
| Rear Window Assy Suits CANOPY015 | CANOPY015-WINDOW | \$641.00 |
| Rear Window Assy for CANOPY015 - Central Locking | CANOPY015-CL WINDOW | \$730.00 |



Spare Parts

| Product Description | Part No. | Retail ea Inc GST |
|---|---------------------|----------------------|
| Rear Window Assy Suits CANOPY017 | CANOPY017-WINDOW | \$641.00 |
| Rear Window Assy CANOPY019 - Central Locking | CANOPY019-CL WINDOW | \$783.00 |
| Rear Window Assy CANOPY020 - Central Locking | CANOPY020-CL WINDOW | \$789.00 |
| Lift Up Window L/H | CANFIBRESPARE006 | \$747.00 |
| Lift Up Window R/H | CANFIBRESPARE007 | \$747.00 |
| Front Sliding Window Complete | CANFIBRESPARE010 | \$297.00 |
| Rubber Seal Kit Bottom (All Models) | CANFIBRESPARE011 | \$56.00 |
| Rear Window Seal Kit (All) | CANFIBRESPARE012 | \$27.00 |
| Side Window Seal Kit (All) | CANFIBRESPARE013 | \$27.00 |
| Side Lift Up Window Gas Strut (All) | CANFIBRESPARE014 | \$54.00 |
| Interior LED Battery Light | CANFIBRESPARE015 | \$54.00 |
| Rear LED Brake Light | CANFIBRESPARE016 | \$74.00 |
| Canopy Mount Kit (All) | CANFIBRESPARE019 | \$54.00 |
| Door Side Bracket and Striker Plate (All) | CANFIBRESPARE020 | \$76.00 |
| Rear Door Side Lock Set (All) | CANFIBRESPARE021 | \$51.00 |
| Rear Door Hinge Set (All) | CANFIBRESPARE022 | \$42.00 |
| Rear Window Gas Strut Brackets (LH / RH) | CANFIBRESPARE023 | \$30.00 |
| Side Window Rubber Grommet (Kit of 4) | CANFIBRESPARE024 | \$30.00 |
| Roof Rail (All Models) | CANFIBRESPARE025 | \$155.00 |
| Fibreglass Canopy Packing Box | CANFIBRESPARE026 | \$226.00 |
| Rear Window Gas Strut LH (All Models) | CANFIBRESPARE027 | \$80.00 |
| Rear Window Gas Strut RH (All Models) | CANFIBRESPARE028 | \$80.00 |
| Rear Door Sidelock RH | CANFIBRESPARE029 | \$42.00 |
| Rear Door Sidelock LH | CANFIBRESPARE030 | \$42.00 |
| Ironman 4x4 Logo for Fibreglass Canopies (All Models) | CANFIBRESPARE031 | \$11.00 |
| Rear Door Bottom Seal (All Models) | CANFIBRESPARE032 | \$12.00 |
| Rear Door Sidelock Set RH (NP300 Only) | CANFIBRESPARE033 | \$42.00 |
| Rear Door Sidelock Set LH (NP300 Only) | CANFIBRESPARE034 | \$42.00 |
| Rear Window Lock and Key Set (NP300 Only) | CANFIBRESPARE035 | \$337.00 |
| Side and Rear Window Handle and Key Set | CANFIBRESPARE036 | \$437.00 |
| Canopy Mount Kit (MQ-MR Triton) | CANFIBRESPARE037 | \$53.00 |
| Canopy Mount Kit (NP300) | CANFIBRESPARE038 | \$53.00 |
| Canopy Mount Kit (Hilux Revo) | CANFIBRESPARE039 | \$53.00 |
| Rear Window Suits CANFIBRE054 (Includes Fibreglass Frame Black Painted) | CANFIBRE054-WINDOW | \$615.00 |
| Rear Window Suits CANFIBRE050 (Includes Fibreglass Frame Black Painted) | CANFIBRE050-WINDOW | \$615.00 |
| Rear Window Suits CANFIBRE051 (Includes Fibreglass Frame Black Painted) | CANFIBRE051-WINDOW | \$615.00 |
| Rear Window Suits CANFIBRE048 (Includes Fibreglass Frame Black Painted) | CANFIBRE048-WINDOW | \$615.00 |
| Rear Window Suits CANFIBRE057 (Includes Fibreglass Frame Black Painted) | CANFIBRE057-WINDOW | \$615.00 |
| Rear Window for Pinnacle 2 ICANOPY048 (Complete) | ICANOPY048-WINDOW | \$615.00 |
| Rear Window for Pinnacle 2 ICANOPY050 (Complete) | ICANOPY050-WINDOW | \$379.00 |
| Rear Window for Pinnacle 2 ICANOPY051 (Complete) | ICANOPY051-WINDOW | \$379.00 |
| Rear Window for Pinnacle 2 ICANOPY054 (Complete) | ICANOPY054-WINDOW | \$379.00 |
| Rear Window for Pinnacle 2 ICANOPY060 (Complete) | ICANOPY060-WINDOW | \$379.00 |
| Rear Window for Pinnacle 2 ICANOPY074 (Complete) | ICANOPY074-WINDOW | \$379.00 |
| Rear Window for Pinnacle 2 ICANOPY082 (Complete) | ICANOPY082-WINDOW | \$379.00 |
| Sliding Window L/H for Pinnacle 2 | ICANOPYSPARE001 | \$261.00 |
| Sliding Window R/H for Pinnacle 2 | ICANOPYSPARE002 | \$261.00 |
| Lift Up Window L/H for Pinnacle 2 | ICANOPYSPARE003 | \$574.00 |
| Lift Up Window R/H for Pinnacle 2 | ICANOPYSPARE004 | \$574.00 |
| Lock and Key Set for Pinnacle 2 (Complete) | ICANOPYSPARE005 | \$366.00 |
| Side Window Gas Struts for Pinnacle 2 | ICANOPYSPARE006 | \$104.00 |
| Rear Window (Small) Gas Strut for Pinnacle 2 | ICANOPYSPARE007 | \$104.00 |
| Rear Window (Large) Gas Strut for Pinnacle 2 | ICANOPYSPARE008 | \$104.00 |
| Central Locking Actuator for Pinnacle 2 | ICANOPYSPARE009 | \$31.00 |
| LED Brake Light for Pinnacle 2 | ICANOPYSPARE010 | \$104.00 |
| LED Internal Light for Pinnacle 2 | ICANOPYSPARE011 | \$62.00 |
| Rubber Strip for Pinnacle 2 Canopy 050, 051, 054 | ICANOPYSPARE013 | \$48.00 |
| Rubber Strip for Pinnacle 2 Canopy 074 | ICANOPYSPARE014 | \$48.00 |
| Rubber Strip for Pinnacle 2 Canopy 082 | ICANOPYSPARE015 | \$48.00 |

Spare Parts

Product Description

Part No.

Retail
ea Inc GST**CANOPIES - CONTINUED**

| | | |
|---|-----------------|---------|
| Rubber Seal for Pinnacle 2 Canopy Side Window | ICANOPYSPARE016 | \$48.00 |
| Paint Protection Tape 150cm for Pinnacle 2 Canopies | ICANOPYSPARE020 | \$41.00 |
| Clamp Covers for Pinnacle 2 Canopies (6) | ICANOPYSPARE021 | \$32.00 |

CANOPY / ROOF RACKS

| | | |
|---|----------------|----------|
| Cross Bar for Trade Style Fibreglass Canopies | IRRCROSSBAR001 | \$287.00 |
| Ironman 4x4 Logo for Cage Roof Racks | BBPART018 | \$5.00 |
| Wheel Clamp to suit 18/22 Cage Roof Racks | IRRWHEEL CLAMP | \$100.00 |

DRIVING LIGHTS

| | | |
|---|-----------------|----------|
| H11 35W 6000k Bulb for IHID001 | IHIDBULB | \$117.00 |
| Bull Bar Light Mount Bracket Suits Blast Series Driving Light | ILEDBLASTMOUNT | \$11.00 |
| Bull Bar Light Mount Bracket Suits Blast Series 2 Driving Light | ILEDBLAST2MOUNT | \$20.00 |
| Bull Bar Light Mount Bracket Suits Comet Series Driving Light | ILEDCOMETMOUNT | \$11.00 |
| Bracket and Fasteners Kit Suits 20W Cube Lights | ILED20SPAREBKTS | \$11.00 |
| Bracket and Fasteners Kit Suits 40W Cube Lights | ILED80SPAREBKTS | \$11.00 |
| Bracket and Fasteners Kit Suits Bright Sabre and Bright Sabre-X Single Row Light Bars | ILBSRSPAREBKTS | \$32.00 |
| Bracket and Fasteners Kit Suits Bright Sabre Single Row Light Bars | ILBSRWSPAREBKTS | \$32.00 |
| Bracket and Fasteners Kit Suits Bright Sabre Dual Row Light Bars | ILBDRSPAREBKTS | \$32.00 |

FRIDGES

| | | |
|--|-----------------|----------|
| Lid for 30, 40 and 50L Fridge | IFRIDGESPARE001 | \$89.00 |
| 12V Lead for Fridges (All models) | IFRIDGESPARE002 | \$30.00 |
| Australian 240V Power Lead for Fridges (All models) | IFRIDGESPARE003 | \$14.00 |
| European Power Lead for Fridges (All models) - While Stocks Last | IFRIDGESPARE004 | \$14.00 |
| Internal Basket for 30L Fridge | IFRIDGESPARE005 | \$39.00 |
| Internal Basket for 40L Fridge | IFRIDGESPARE006 | \$43.00 |
| Internal Basket for 50L Fridge | IFRIDGESPARE007 | \$52.00 |
| Internal LED Light Suits all Fridges | IFRIDGESPARE008 | \$8.00 |
| Digital Control Panel for 30, 40 and 50L Fridge | IFRIDGESPARE009 | \$37.00 |
| Control PCB for 30, 40 and 50L Fridge | IFRIDGESPARE010 | \$33.00 |
| Compressor Control Suits all Fridges | IFRIDGESPARE011 | \$458.00 |
| Battery Protection for 30, 40 and 50L Fridge | IFRIDGESPARE012 | \$7.00 |
| DC Fan for 30, 40 and 50L Fridge | IFRIDGESPARE013 | \$18.00 |
| Digital Control Panel for 65L Fridge Dual Control | IFRIDGESPARE014 | \$95.00 |
| Digital Control Panel for 74L Fridge Single | IFRIDGESPARE015 | \$95.00 |
| DC Fan for 65 and 74L Fridge | IFRIDGESPARE016 | \$20.00 |
| Hinge for 65 and 74L Fridge (x 1) | IFRIDGESPARE017 | \$7.00 |
| American Power Lead for Fridges (All models) | IFRIDGESPARE018 | \$14.00 |
| Internal Basket Small for 65L Fridge | IFRIDGESPARE019 | \$29.00 |
| Internal Basket Large for 65L Fridge | IFRIDGESPARE020 | \$35.00 |
| Internal Basket Small for 74L Fridge | IFRIDGESPARE021 | \$27.00 |
| Internal Basket Large for 74L Fridge | IFRIDGESPARE022 | \$37.00 |
| Thermometer Probe for 30, 40 and 50L Fridge | IFRIDGESPARE023 | \$7.00 |
| Hinge and Spring for 30, 40 and 50L Fridge Lids | IFRIDGESPARE024 | \$4.00 |
| Thermometer Probe for 65 and 74L Fridge | IFRIDGESPARE025 | \$6.00 |
| Thermometer Probe for 65L Freezer Side | IFRIDGESPARE026 | \$6.00 |
| Digital Control Panel for 30, 40 and 50L Fridge (NEW) | IFRIDGESPARE027 | \$54.00 |
| Solenoid Valve for 65L Fridge | IFRIDGESPARE028 | \$121.00 |

INSTANT AWNINGS

| | | |
|------------------------------|----------------|---------|
| Awning L Mounting Brackets | IAWNINGSARE001 | \$25.00 |
| Awning Hinge Joint for Poles | IAWNINGSARE002 | \$7.00 |
| Awning Strap and Buckle | IAWNINGSARE003 | \$6.00 |
| Awning Foot Piece with Rope | IAWNINGSARE004 | \$3.00 |
| Awning End Pin | IAWNINGSARE005 | \$3.00 |
| Awning Swivel Spacer | IAWNINGSARE006 | \$5.00 |



Spare Parts

| Product Description | Part No. | Retail ea Inc GST |
|--|-----------------|----------------------|
| Awning Twist Lock | IAWNINGSPARE007 | \$5.00 |
| Awning Outer Pole 25mm - Tube Only | IAWNINGSPARE008 | \$20.00 |
| Awning Inner Pole 22mm - Tube Only | IAWNINGSPARE009 | \$20.00 |
| Replacement Awning Cover | IAWNINGSPARE010 | \$58.00 |
| Awning Square Rubber Catch | IAWNINGSPARE011 | \$6.00 |
| Awning 2.0 Horizontal External Pole | IAWNINGSPARE012 | \$40.00 |
| Awning 2.5 Horizontal External Pole | IAWNINGSPARE013 | \$40.00 |
| Plastic Clip for Awning Room/ Net | IAWNINGSPARE014 | \$3.00 |
| Horizontal Pole 2m | IAWNINGPART001 | \$26.00 |
| Horizontal Pole 2.5m | IAWNINGPART002 | \$33.00 |
| Vertical Pole | IAWNINGPART003 | \$26.00 |
| Rubber Stopper | IAWNINGPART004 | \$5.00 |
| Flex Joint | IAWNINGPART005 | \$9.00 |
| Light Strip and Dimmer Kit | IAWNINGPART006 | \$61.00 |
| 'L' Mounting Bracket (1) | IAWNINGPART007 | \$10.00 |
| Guy Ropes and Peg Kit in Bag | IAWNINGPART008 | \$21.00 |
| Poles, Ropes, Pegs to suit Awning Room | IAWNINGPART009 | \$38.00 |
| Single Guy Ropes (Pair) | IAWNINGPART010 | \$10.00 |

ROOFTOP TENTS

| | | |
|---|-------------------|----------|
| Travel Cover for Tent | IROOFTENTSPARE001 | \$178.00 |
| Mattress Cover | IROOFTENTSPARE002 | \$58.00 |
| Mounting Extrusions (x 2) | IROOFTENTSPARE003 | \$71.00 |
| Mounting Sliding Plate and Bolt | IROOFTENTSPARE004 | \$6.00 |
| Mounting Clamp | IROOFTENTSPARE005 | \$8.00 |
| Ladder Bracket (x 2) | IROOFTENTSPARE006 | \$16.00 |
| Bungee Cords (x 4) | IROOFTENTSPARE007 | \$6.00 |
| Window Rods (x 6) | IROOFTENTSPARE008 | \$58.00 |
| Straps for Tent Cover (x 2) | IROOFTENTSPARE010 | \$9.00 |
| Front Extrusion Bow | IROOFTENTSPARE011 | \$22.00 |
| Base Extrusion 1295mm | IROOFTENTSPARE012 | \$32.00 |
| Base Extrusion 1130mm | IROOFTENTSPARE013 | \$30.00 |
| Base Mid Extrusion Tongue/Groove (Pair) | IROOFTENTSPARE014 | \$48.00 |
| Tent Base Corner Piece | IROOFTENTSPARE015 | \$6.00 |
| Main Ladder | IROOFTENTSPARE016 | \$228.00 |
| Tent Fly Sheet | IROOFTENTSPARE017 | \$187.00 |
| Zip on Base For Cover | IROOFTENTSPARE018 | \$17.00 |
| Mattress | IROOFTENTSPARE019 | \$213.00 |
| Roof Top Tent Bow | IROOFTENTSPARE020 | \$51.00 |

SLIDE-AWAY ROLL UP HARD TONNEAU COVERS

| | | |
|--------------------------------------|-------------------|----------|
| Slide-Away Metal Badge | ISLIDESPAREBADGE | \$20.00 |
| Slide-Away Brackets 100mm (Set of 6) | ISLIDESPAREBKT100 | \$146.00 |
| Slide-Away Brackets 115mm (Set of 6) | ISLIDESPAREBKT115 | \$146.00 |
| Slide-Away Brackets 45mm (Set of 6) | ISLIDESPAREBKT45 | \$146.00 |
| Slide-Away Brackets 70mm (Set of 6) | ISLIDESPAREBKT70 | \$146.00 |
| Slide-Away Brackets 80mm (Set of 6) | ISLIDESPAREBKT80 | \$146.00 |
| Slide-Away Clutch | ISLIDESPARECLUTCH | \$501.00 |
| Slide-Away ECU | ISLIDESPAREECU | \$501.00 |
| Slide-Away Fastener Pack | ISLIDESPAREFSTR | \$53.00 |
| Slide-Away LED Light Module | ISLIDESPARELIGHT | \$74.00 |
| Slide-Away Drive Motor | ISLIDESPAREMOTOR | \$408.00 |
| Slide-Away Remote Control | ISLIDESPAREREMOTE | \$49.00 |

Spare Parts

Product Description

Part No.

Retail
ea Inc GST

SNORKELS

| | | | |
|--|--------------------------|--|---------|
| Snorkel Mesh Inset Suits 3" and 3.5" Hat | ISNORKELSPARE001 | | \$34.00 |
| Overflow Bottle Suits ISNORKEL020 | ISNORKELSPARE002 | | \$62.00 |
| 3" Snorkel Hat | ISNORKEL 3" HAT | | \$46.00 |
| 3.5" Snorkel Hat | ISNORKEL 3.5" HAT | | \$46.00 |
| 4" Snorkel Hat | ISNORKEL 4" HAT | | \$46.00 |

SUSPENSION

| | | | |
|--|-------------------|----|----------|
| Upper Control Arm Bush to Suit UCA001FA | UCAB001 | ea | \$30.00 |
| Upper Control Arm Bush to Suit UCA041FA | UCAB041 | ea | \$35.00 |
| Upper Control Arm Bush to Suit UCA041FAS | UCAB041S | ea | \$35.00 |
| Upper Control Arm Bush to Suit UCA048FA | UCAB048 | ea | \$35.00 |
| Upper Control Arm Bush to Suit UCA050FA | UCAB050 | ea | \$35.00 |
| Upper Control Arm Bush to Suit UCA054FA | UCAB054 | ea | \$30.00 |
| Upper Control Arm Bush to Suit UCA056FA | UCAB056 | ea | \$35.00 |
| Upper Control Arm Bush to Suit UCA073FA | UCAB073 | ea | \$35.00 |
| Upper Control Arm Bush to Suit UCA074FA | UCAB074 | ea | \$35.00 |
| Upper Control Arm Bush to Suit UCA075FA | UCAB075 | ea | \$35.00 |
| Ball Joint Assembly to Suit UCA001FA | UBJ001K | ea | \$39.00 |
| Ball Joint Assembly to Suit UCA041FA | UBJ041K | ea | \$56.00 |
| Ball Joint Assembly to Suit UCA041FAS | UBJ041SK | ea | \$56.00 |
| Ball Joint Assembly to Suit UCA048FA | UBJ048K | ea | \$48.00 |
| Ball Joint Assembly to Suit UCA050FA | UBJ050K | ea | \$48.00 |
| Ball Joint Assembly to Suit UCA054FA | UBJ054K | ea | \$39.00 |
| Ball Joint Assembly to Suit UCA056FA | UBJ056K | ea | \$51.00 |
| Ball Joint Assembly to Suit UCA073FA | UBJ073K | ea | \$51.00 |
| Ball Joint Assembly to Suit UCA074FA | UBJ074K | ea | \$56.00 |
| Ball Joint Assembly to Suit UCA075FA | UBJ075K | ea | \$51.00 |
| Ball Joint Assembly to Suit UCA090FA | UBJ090K | ea | \$46.36 |
| Leaf Spring 3/8" x 4" Centre Bolt | 099 | | \$8.00 |
| Leaf Spring 5/16" x 4" Centre Bolt | 098 | | \$8.00 |
| Leaf Spring 3/8" x 4" Centre Bolt - Extended Head | 635 | | \$15.00 |
| Leaf Spring Plastic Clip Liner | CLINER001 | | \$4.00 |
| Leaf Spring Plastic Anti-Friction Pad (Oval Locator) | AFPAD001 | | \$4.00 |
| Leaf Spring Plastic Anti-Friction Pad (Round Locator) | AFPAD002 | | \$4.00 |
| Leaf Spring 1 Degree Wedge Kit | IWEDGE04 | | \$59.00 |
| Leaf Spring 2 Degree Wedge Kit | IWEDGE08 | | \$59.00 |
| Leaf Spring 3 Degree Wedge Kit | IWEDGE10 | | \$59.00 |
| Leaf Spring 4 Degree Wedge Kit | IWEDGE12 | | \$59.00 |
| Rubber Sway Bar Chassis Bush 36mm to Suit Nissan Patrol Y62 Front | ISBB60036R | | \$30.00 |
| Rubber Sway Bar Axle Mounting Bush 27mm to Suit Nissan Patrol Y62 Rear | ISBB60027R | | \$30.00 |
| Rubber Sway Bar Chassis Bush 33mm to Suit Toyota Hilux 2015+ Front | ISBB8033R | | \$30.00 |
| Rubber Sway Bar Chassis Bush 38mm to Suit Toyota LC 200 Front | ISBB20038R | | \$30.00 |
| Rubber Sway Bar Axle Mounting Bush 33mm to Suit Toyota LC 200 Rear | ISBB20033R | | \$30.00 |
| Rubber Sway Bar End Bush to Suit Toyota LC 200 Rear | ISBB200REB | | \$11.00 |
| Rubber Sway Bar Chassis Bush 33mm to Suit Toyota LC 70 Front Diesel | ISBB78933R | | \$30.00 |
| Rubber Sway Bar End Bush to Suit Toyota LC 70 Front Diesel | ISBB789REB | | \$30.00 |
| Chassis Mounting D Bracket to Suit Toyota LC 70 Front Diesel | ISBB789DB | | \$30.00 |
| Rubber Sway Bar Chassis Bush 33mm to Suit Toyota LC 70 Front Petrol | ISBB78933R | | \$30.00 |
| Rubber Sway Bar End Bush to Suit Toyota LC 70 Front Petrol | ISBB789REB | | \$30.00 |
| Chassis Mounting D Bracket to Suit Toyota LC 70 Front Petrol | ISBB789DB | | \$30.00 |
| Rubber Sway Bar Axle Mounting Bush 30mm to Suit Toyota LC 70 Rear | ISBB78930R | | \$30.00 |
| Rubber Sway Bar End Bush to Suit Toyota LC 70 Rear | ISBB789REB | | \$30.00 |
| Axle Mounting D Bracket to Suit Toyota LC 70 Rear | ISBB789DB | | \$30.00 |
| Chassis Mounting Bracket Set to Suit Toyota LC 70 Rear | ISBB789RBK | | \$116.00 |

Spare Parts

| Product Description | Part No. | Retail ea Inc GST |
|--|---------------|----------------------|
| SWAGS | | |
| Poles to Suit Single Dome Swag (Set of 3) | ISWAGPART001 | \$110.00 |
| Poles to Suit Double Dome Swag (Set of 3) | ISWAGPART002 | \$126.00 |
| Swag Single Mattress | ISWAGSPARE001 | \$108.00 |
| Swag Double Mattress | ISWAGSPARE002 | \$134.00 |
| TOW BARS / REAR PROTECTION BARS | | |
| Tow Bar Tongue and Ball | RTBSPARE002 | \$94.00 |
| LED Numberplate Light | RTBSPARE003 | \$18.00 |
| Plastic Sensor Cover to suit RTB067GLS | RTBSPARE004 | \$27.00 |
| Universal Parking Sensor Holder to Suit Raid Bars (Lock Nut Style) | RAPIDPSHUNI | \$48.00 |
| UBP UNDERBODY MOUNTING KITS | | |
| Mounting Kit for UBPO19 | UBPO19MK | \$41.00 |
| Mounting Kit for UBPO19SC | UBPO19SCMK | \$41.00 |
| Mounting Kit for UBPO33 | UBPO33MK | \$41.00 |
| Mounting Kit for UBPO41 | UBPO41MK | \$41.00 |
| Mounting Kit for UBPO47 | UBPO47MK | \$41.00 |
| Mounting Kit for UBPO47 | UBPO48MK | \$41.00 |
| Mounting Kit for UBPO50 | UBPO50MK | \$41.00 |
| Mounting Kit for UBPO51 | UBPO51MK | \$41.00 |
| Mounting Kit for UBPO54 | UBPO54MK | \$41.00 |
| Mounting Kit for UBPO55 | UBPO55MK | \$41.00 |
| Mounting Kit for UBPO56 | UBPO56MK | \$41.00 |
| Mounting Kit for UBPO57 | UBPO57MK | \$41.00 |
| Mounting Kit for UBP201SY | UBP201SYMK | \$41.00 |
| WINCHES | | |
| Remote With Wireless Receiver Unit for WWB9500/ 12000 | WWB001 | \$99.00 |
| Solenoid (All models) | WWB002 | \$79.00 |
| Motor for WWB9500 | WWB003 | \$237.00 |
| Motor with Brake Attachment for WWB9500 | WWB003B | \$237.00 |
| Motor for WWB12000 - New | WWB004 | \$257.00 |
| Motor with Brake Attachment for WWB12000 | WWB004B | \$257.00 |
| Diff Breather Kit for WWB9500/ 12000 | WWB005 | \$14.00 |
| Tie Bars New Shape (2 Pc) (All models) | WWB006 | \$14.00 |
| Clutch Handle (All models) | WWB007 | \$14.00 |
| Gearbox Complete for WWW9500/ WWB9500 | WWB008 | \$274.00 |
| Gearbox Complete for WWW12000/ WWB12000 | WWB009 | \$274.00 |
| Brush Kit For Motor (All models) | WWB010 | \$29.00 |
| Replacement Hook (All models) | WWB011 | \$31.00 |
| Drum Support Housing Motor End (All models) | WWB012 | \$41.00 |
| Drum Support Housing Gearbox End (All models) | WWB013 | \$41.00 |
| Complete Control Box With Remote (All models) | WWB014 | \$315.00 |
| Wireless Plug (All models) | WWB015 | \$7.00 |
| Winch Cam Lock Brake System for WWW9500/ 12000 | WWB016 | \$14.00 |
| Winch Drum (All models) | WWB017 | \$61.00 |
| Electric Motor Gasket (All models) | WWB018 | \$4.00 |
| Control Box Lead Socket for WWB9500/ 12000 | WWB023 | \$14.00 |
| Plug In Lead for WWB9500/ 12000 | WWB024 | \$20.00 |
| Internal Brake Replacement for WWW9500/ 12000 | WWB025 | \$61.00 |
| Ferrule and Pin for Winch Hook | WWB026 | \$15.00 |
| Winch Damper Blanket (All models) | WINCH BLANKET | \$41.00 |
| Winch Cam-Lock Brake System for WWB9500/ 12000 | WWWBRAKE | \$89.00 |
| Winch Clutch Handle | WWWCLUTCH | \$14.00 |
| Drum For Winches | WWWDRUM | \$61.00 |
| Drum Support Bush | WWWDRUMBUSH | \$9.00 |

Spare Parts

Product Description

Part No.

Retail
ea Inc GST

WINCHES - CONTINUED

| | | |
|---|---------------------------|----------|
| End Plate For Gear Box | WWWENDPLATE GBOX | \$41.00 |
| End Plate For Motor | WWWENDPLATE MOTOR | \$41.00 |
| Fairlead Rollers For Ironman Winch | WWWFAIRLEAD | \$79.00 |
| 12000lb Winch Motor | WWWMOTOR12 | \$237.00 |
| 9500lb Winch Motor | WWWMOTOR95 | \$237.00 |
| O-Ring For Inside The Drum For The Brake | WWWORING | \$7.00 |
| Wireless Remote For Winch | WWWREMOTE WIRELESS | \$61.00 |
| Steel Cable Lug for WWW12000/ WWB12000 | WWWTAG12 | \$6.00 |
| Steel Cable Lug for WWW9500/ WWB9500 | WWWTAG95 | \$6.00 |
| 12000lb Winch Carton | WWWCARTON12 | \$18.00 |
| 9500lb Winch Carton | WWWCARTON95 | \$18.00 |
| Box for WWB9500 | WWB019 | \$4.00 |
| Box for WWW9500SR | WWB020 | \$4.00 |
| Box for WWB12000 | WWB021 | \$4.00 |
| Box for WWB12000SR | WWB022 | \$4.00 |
| Winch Control Extension Plug - 500mm Length | WWB030 | \$27.00 |
| Winch Control Extension Plug - 1000mm Length | WWB031 | \$32.00 |
| Winch Control Extension Plug - 1500mm Length | WWB032 | \$37.00 |
| Winch Control Box Mount - Universal Fit | WWBCP001 | \$89.00 |
| Winch Control Box Mount - To Suit 2022+ Next-Gen Ranger | WWBCP110 | \$89.00 |

- Replacement Battery A23 - Not a Spare Part

MISCELLANEOUS

| | | |
|---|-----------------------------|---------|
| Air Compressor Replacement Hose | ICOMPRESSOR AIR LINE | \$28.00 |
| Exhaust Generic Rubber Hanger (set 3) - 40-75mm | IEXH4075 | \$14.00 |

Product Install Time Guide

ACCESSORIES AND SUSPENSION

Effective 1 December 2022

Average Installation Times (in hours)

Product Description

Part No.

Retail
ea Inc GST

| INSTALLATION OF IRONMAN 4x4 PRODUCTS TO SUIT | TOYOTA HILUX MY21 | FORD RANGER | ISUZU D-MAX | SUZUKI GJ JIMNY | TOYOTA LANDCRUISER 200 |
|--|----------------------|----------------|----------------|--------------------|---------------------------|
| BULL BARS | | | | | |
| Commercial Bars | 3.5 | 4 | 4.5 | 2.5 | 4 |
| Commercial Deluxe Bars | 3.5 | 4 | 4.5 | N/A | 4 |
| Sensors/Cameras/Headlight Washers | 0.5 | 1 | 0.25 | N/A | 1 |
| Wire in Fog Lights using OEM Loom and Switches | 0.5 | N/A | 0.5 | N/A | 0.5 |
| Additional Wire in Fog Lights | 1 | 1 | 1 | N/A | 1 |
| WINCHES | | | | | |
| Note: Winch control box relocation may be required if the vehicle is fitted with additional accessories, radar and or camera | | | | | |
| At Time of Installing Bull Bar | 1.5 | 1.5 | 1.5 | 2 | 1.5 - 2 |
| Fit to Existing Bull Bar | 3 | 3 | 3 | 4 | 3 |
| RECOVERY POINTS | | | | | |
| At Time of Installing Bar | 0.5 | 0.5 | 0.5 | 0.5 | 0.5 |
| Fit to Existing Bar | 1 | 1 | 1 | 1 | 1 |
| SIDE STEPS AND RAILS | | | | | |
| Side Steps | 1.5 | 2 | 1.5 | N/A | 2 |
| Side Steps and Rails | 2.5 | 3 | 2.5 | N/A | 3 |
| TOWBARS | | | | | |
| Towbar | 2 | 2 | 2 | N/A | N/A |
| Rear Protection Towbar | 2 | 2 | 2 | N/A | N/A |
| Rear Protection Towbar with Sensors | 2.5 | 2.5 | 2.5 | N/A | N/A |
| SUSPENSION | | | | | |
| Suspension Fitment | 4 | 4 | 4 | 3 | 4.5 |
| Upper Control Arm | 2 | 2 | 2 | N/A | 2 |
| Wheel Alignment | 1 | 1 | 1 | 0.5 | 1 |
| LIGHTS | | | | | |
| Light Bar or Driving Lights on Bull Bar | 1.5 | 1 | 1 | 1.5 | 1 |
| SNORKELS | | | | | |
| All Snorkels | 3 | 3 | 3 | 2 | 3 |
| LONG RANGE FUEL TANKS | | | | | |
| Tanks | 4 | 3.5 | 3.5 | N/A | N/A |
| UNDERBODY PROTECTION KITS | | | | | |
| UBP | 0.75 | 0.75 | 1 | N/A | 0.75 |
| CANOPIES | | | | | |
| ABS Plastic | 2 | 2 | 3 | N/A | N/A |
| Pinnacle Fibreglass | 2 | 2 | 3 | N/A | N/A |
| SLIDE-AWAY | | | | | |
| Roll Up Tonneau Cover | 2 | 2 | 3 | N/A | N/A |
| ROOF RACKS AND FEET | | | | | |
| Racks | 1.5 | 1.5 | 1.5 | 1 | 2 |
| DRAWER SYSTEMS | | | | | |
| Twin Drawers | 1 | 1 | 1 | N/A | 2 |
| Single Drawers | 0.75 | 0.75 | 0.75 | N/A | 1 |
| Wing Kit | 1 | 1 | 1 | N/A | 1 |

Average Installation Times (in hours)

Product Description

Part No.

Retail
ea Inc GST

| INSTALLATION OF IRONMAN 4X4 PRODUCTS TO SUIT | TOYOTA LANDCRUISER 79 | MITSUBISHI TRITON MR | TOYOTA PRADO 150 | NISSAN NP300 NAVARA | NISSAN GU PATROL |
|--|--------------------------|-------------------------|---------------------|------------------------|---------------------|
| BULL BARS | | | | | |
| Commercial Bars | 3 | 4.5 | 4.5 | 3 | 3 |
| Commercial Deluxe Bars | 3 | 4.5 | 4.5 | 3 | 3 |
| Sensors/Cameras/Headlight Washers | N/A | 0.5 | 0.15 | N/A | N/A |
| Wire in Fog Lights using OEM Loom and Switches | N/A | 0.5 | 0.15 | 0.5 | N/A |
| Additional Wire in Fog Lights | 1 | 1 | 1 | 1 | 1 |
| WINCHES | | | | | |
| Note: Winch control box relocation may be required if the vehicle is fitted with additional accessories, radar and or camera | | | | | |
| At Time of Installing Bull Bar | 1.5 | 1.5 | 1.5 | 1.5 | 1.5 |
| Fit to Existing Bull Bar | 3 | 3 | 3 | 3 | 3 |
| RECOVERY POINTS | | | | | |
| At Time of Installing Bar | 0.5 | 0.5 | 0.5 | 0.5 | 0.5 |
| Fit to Existing Bar | 1 | 1 | 1 | 3 | 1 |
| SIDE STEPS AND RAILS | | | | | |
| Side Steps | 1.5 | 2.5 | 1.5 | 2 | 1.5 |
| Side Steps and Rails | 2.5 | 2.5 | 2.5 | 3 | 2.5 |
| TOWBARS | | | | | |
| Towbar | N/A | 2 | N/A | 2 | N/A |
| Rear Protection Towbar | N/A | 2 | N/A | 2 | N/A |
| Rear Protection Towbar with Sensors | N/A | 3 | N/A | 2.5 | N/A |
| SUSPENSION | | | | | |
| Suspension Fitment | 3 | 4 | 4 | 3 | 2 |
| Upper Control Arm | N/A | 2 | 2 | 2 | N/A |
| Wheel Alignment | 0.5 | 1 | 1 | 1 | 0.5 |
| LIGHTS | | | | | |
| Light Bar or Driving Lights on Bull Bar | 1 | 1 | 2.5 | 1.5 | 1 |
| SNORKELS | | | | | |
| All Snorkels | 3 | 3 | 3 | 4 | 4 |
| LONG RANGE FUEL TANKS | | | | | |
| Tanks | N/A | 3.5 | N/A | 3.5 | N/A |
| UNDERBODY PROTECTION KITS | | | | | |
| UBP | 0.75 | 0.75 | 1 | 1.5 | N/A |
| CANOPIES | | | | | |
| ABS Plastic | N/A | 3 | N/A | 2 | N/A |
| Pinnacle Fibreglass | N/A | 3 | N/A | 2 | N/A |
| SLIDE-AWAY | | | | | |
| Roll Up Tonneau Cover | N/A | 3 | N/A | 2 | N/A |
| ROOF RACKS AND FEET | | | | | |
| Racks | N/A | 1.5 | 2 | 1.5 | N/A |
| DRAWER SYSTEMS | | | | | |
| Twin Drawers | 1 | 1 | 2 | 1 | N/A |
| Single Drawers | 0.75 | 0.75 | 1 | 0.7 | N/A |
| Wing Kit | 1 | 1 | 1 | 1 | N/A |





GVM Upgrades

CATALOGUE AND PRICE LIST

Effective 1 December 2022

 **GVM**
IRONMAN UPGRAD

GVM Upgrades

Product Description

Part No.

Retail
ea Inc GST

GVM UPGRADE TO SUIT FORD RANGER

PX MK III (NOT USA MODEL) 7/2018 TO 2022 - (PAGE 54)

| | Front Axle Rating | Rear Axle Rating | Gross Vehicle Mass (GVM) | Gross Combined Mass (GCM) | Towing Capacity (Braked) |
|--------------------------------|-------------------|------------------|--------------------------|---------------------------|--------------------------|
| Original Equipment (OE) | 1480kg | 1850kg | 3200kg | 6000kg | 3500kg |
| Ironman 4x4 | 1500kg | 2000kg | 3500kg | 6000kg | 3500kg |

These figures are presented as a guide only. Always refer to the owner's manual for load ratings specific to the vehicle

POST REGISTRATION - 3500KG

Additional Payload

| | | | |
|---------------------------------------|--------|----------------------|-----------|
| Foam Cell Shocks - Temporary Load | +300kg | FOR005BKFGVM1 | \$3407.00 |
| Foam Cell Shocks - Permanent Load | +300kg | FOR005CKFGVM1 | \$3462.00 |
| Foam Cell Pro Shocks - Temporary Load | +300kg | FOR005BKPGVM1 | \$3844.00 |
| Foam Cell Pro Shocks - Permanent Load | +300kg | FOR005CKPGVM1 | \$3899.00 |

Federal Approval VTA-047511 - OE Approval No. VTA-043280

- Only available through authorised Ironman 4x4 GVM upgrade installers
- Plus engineering sign off (Post Registration Only)
- Post Registration, State Approval - Vehicle must be inspected and approved by state authorised automotive engineer for issue of modification plate
- GVM orders must be submitted via the GVM Portal

GVM UPGRADE KIT CONTENTS

| | | | |
|-----------------------|----------------------------|-----------------------------|--------------------------------------|
| Shock Absorbers | Leaf Springs | Centre Bearing Spacer Kit | SSM Compliance Plate (pre reg. only) |
| Strut Shock Absorbers | U-Bolts | Greasable Shackles and Pins | GVM Stickers |
| Coil Springs | Polyurethane Spring Bushes | Tyre Placard | |

Product Description

Part No.

Retail
ea Inc GST

GVM UPGRADE TO SUIT FORD RANGER

PX MK II (NOT USA MODEL) 2015 TO 6/2018 - (PAGE 58)

| | Front Axle Rating | Rear Axle Rating | Gross Vehicle Mass (GVM) | Gross Combined Mass (GCM) | Towing Capacity (Braked) |
|--------------------------------|-------------------|------------------|--------------------------|---------------------------|--------------------------|
| Original Equipment (OE) | 1480kg | 1850kg | 3200kg | 6000kg | 3500kg |
| Ironman 4x4 | 1500kg | 2000kg | 3500kg | 6000kg | 3500kg |

These figures are presented as a guide only. Always refer to the owner's manual for load ratings specific to the vehicle

POST REGISTRATION - 3500KG

Additional Payload

| | | | |
|---------------------------------------|--------|----------------------|-----------|
| Foam Cell Shocks - Temporary Load | +300kg | FOR001BKFGVM1 | \$3406.00 |
| Foam Cell Shocks - Permanent Load | +300kg | FOR001CKFGVM1 | \$3461.00 |
| Foam Cell Pro Shocks - Temporary Load | +300kg | FOR001BKPGVM1 | \$3843.00 |
| Foam Cell Pro Shocks - Permanent Load | +300kg | FOR001CKPGVM1 | \$3898.00 |

Federal Approval VTA-047511 - OE Approval No. VTA-043280

- Only available through authorised Ironman 4x4 GVM upgrade installers
- Plus engineering sign off (Post Registration Only)
- Post Registration, State Approval - Vehicle must be inspected and approved by state authorised automotive engineer for issue of modification plate
- GVM orders must be submitted via the GVM Portal

GVM UPGRADE KIT CONTENTS

| | | | |
|-----------------------|----------------------------|-----------------------------|--------------|
| Shock Absorbers | Leaf Springs | Centre Bearing Spacer Kit | GVM Stickers |
| Strut Shock Absorbers | U-Bolts | Greasable Shackles and Pins | |
| Coil Springs | Polyurethane Spring Bushes | Tyre Placard | |

GVM UPGRADE TO SUIT FORD RANGER

T6 PX (NOT USA MODEL) 2011 TO 2015 - (PAGE 62)

| | Front Axle Rating | Rear Axle Rating | Gross Vehicle Mass (GVM) | Gross Combined Mass (GCM) | Towing Capacity (Braked) |
|--------------------------------|-------------------|------------------|--------------------------|---------------------------|--------------------------|
| Original Equipment (OE) | 1480kg | 1850kg | 3200kg | 6000kg | 3500kg |
| Ironman 4x4 | 1500kg | 2000kg | 3500kg | 6000kg | 3500kg |

These figures are presented as a guide only. Always refer to the owner's manual for load ratings specific to the vehicle

POST REGISTRATION - 3500KG

Additional Payload

| | | | |
|---------------------------------------|--------|----------------------|-----------|
| Foam Cell Shocks - Temporary Load | +300kg | FOR001BKFGVM1 | \$3406.00 |
| Foam Cell Shocks - Permanent Load | +300kg | FOR001CKFGVM1 | \$3461.00 |
| Foam Cell Pro Shocks - Temporary Load | +300kg | FOR001BKPGVM1 | \$3843.00 |
| Foam Cell Pro Shocks - Permanent Load | +300kg | FOR001CKPGVM1 | \$3898.00 |

Federal Approval VTA-047511 - OE Approval No. VTA-043280

- Only available through authorised Ironman 4x4 GVM upgrade installers
- Plus engineering sign off (Post Registration Only)
- Post Registration, State Approval - Vehicle must be inspected and approved by state authorised automotive engineer for issue of modification plate
- GVM orders must be submitted via the GVM Portal

GVM UPGRADE KIT CONTENTS

| | | | |
|-----------------------|----------------------------|-----------------------------|--------------|
| Shock Absorbers | Leaf Springs | Centre Bearing Spacer Kit | GVM Stickers |
| Strut Shock Absorbers | U-Bolts | Greasable Shackles and Pins | |
| Coil Springs | Polyurethane Spring Bushes | Tyre Placard | |

GVM Upgrades

Product Description

Part No.

Retail
ea Inc GST

GVM UPGRADE TO SUIT HOLDEN COLORADO

RG 2016+ - (PAGE 81)

| | Front Axle Rating | Rear Axle Rating | Gross Vehicle Mass (GVM) | Gross Combined Mass (GCM) | Towing Capacity (Braked) |
|--------------------------------|-------------------|------------------|--------------------------|---------------------------|--------------------------|
| Original Equipment (OE) | 1450kg | 1850kg | 3150kg | 6000kg | 3500kg |
| Ironman 4x4 | 1500kg | 2000kg | 3500kg | 6000kg | 3500kg |

These figures are presented as a guide only. Always refer to the owner's manual for load ratings specific to the vehicle

POST REGISTRATION - 3500KG

Additional Payload

| | | | |
|--------------------------------|-------------|------------------------|-----------|
| Foam Cell - Temporary Load | up to 400kg | HOLD021CKF2GVM1 | \$3462.00 |
| Foam Cell - Permanent Load | up to 400kg | HOLD021DKF2GVM1 | \$3462.00 |
| Foam Cell Pro - Temporary Load | up to 400kg | HOLD021CKP2GVM1 | \$3899.00 |
| Foam Cell Pro - Permanent Load | up to 400kg | HOLD021DKP2GVM1 | \$3899.00 |

Federal Approval VTA-050676 - OE Approval No. VTA-049276

- Only available through authorised Ironman 4x4 GVM upgrade installers
- Plus engineering sign off (Post Registration Only)
- Post Registration, State Approval - Vehicle must be inspected and approved by state authorised automotive engineer for issue of modification plate
- GVM orders must be submitted via the GVM Portal

GVM UPGRADE KIT CONTENTS

| | | |
|-----------------------|----------------------------|-----------------------------|
| Shock Absorbers | Leaf Springs | Greasable Shackles and Pins |
| Strut Shock Absorbers | U-Bolts | Tyre Placard |
| Coil Springs | Polyurethane Spring Bushes | GVM Stickers |

GVM UPGRADE TO SUIT HOLDEN COLORADO

RG 2012 TO 2015 - (PAGE 84)

| | Front Axle Rating | Rear Axle Rating | Gross Vehicle Mass (GVM) | Gross Combined Mass (GCM) | Towing Capacity (Braked) |
|--------------------------------|-------------------|------------------|--------------------------|------------------------------------|------------------------------------|
| Original Equipment (OE) | 1300kg | 1680kg | 2900kg | 5400kg - Petrol 5900kg - Diesel | 2500kg - Petrol 3000kg - Diesel |
| Ironman 4x4 | 1550kg | 1950kg | 3500kg | 5400kg - Petrol 5900kg - Diesel | 2500kg - Petrol 3000kg - Diesel |

These figures are presented as a guide only. Always refer to the owner's manual for load ratings specific to the vehicle

POST REGISTRATION - 3500KG

Additional Payload

| | | | |
|--------------------------------|-------------|-----------------------|-----------|
| Foam Cell - Temporary Load | up to 600kg | HOLD021CKFGVM1 | \$3462.00 |
| Foam Cell - Permanent Load | up to 600kg | HOLD021DKFGVM1 | \$3462.00 |
| Foam Cell Pro - Temporary Load | up to 600kg | HOLD021CKPGVM1 | \$3899.00 |
| Foam Cell Pro - Permanent Load | up to 600kg | HOLD021DKPGVM1 | \$3899.00 |

Federal Approval VTA-050676 - OE Approval No. VTA-043669

- Only available through authorised Ironman 4x4 GVM upgrade installers
- Plus engineering sign off (Post Registration Only)
- Post Registration, State Approval - Vehicle must be inspected and approved by state authorised automotive engineer for issue of modification plate
- GVM orders must be submitted via the GVM Portal

GVM UPGRADE KIT CONTENTS

| | | |
|-----------------------|----------------------------|-----------------------------|
| Shock Absorbers | Leaf Springs | Greasable Shackles and Pins |
| Strut Shock Absorbers | U-Bolts | Tyre Placard |
| Coil Springs | Polyurethane Spring Bushes | GVM Stickers |



GVM UPGRADE TO SUIT ISUZU D-MAX

2020-12/2021 - (PAGE 99) | 2022+ (PAGE 99)

| | Front Axle Rating | Rear Axle Rating | Gross Vehicle Mass (GVM) | Gross Combined Mass (GCM) | Towing Capacity (Braked) |
|--------------------------------|-------------------|------------------|--------------------------|---------------------------|--------------------------|
| Original Equipment (OE) | 1450kg | 1910kg | 3100kg | 5950kg | 3500kg |
| Ironman 4x4 | 1500kg | 2000kg | 3500kg | 5950kg | 3500kg |

These figures are presented as a guide only. Always refer to the owner's manual for load ratings specific to the vehicle

PRE REGISTRATION - 3500KG
Additional Payload

| | | | |
|--------------------------------|-------------|-----------------------|-----------|
| Foam Cell - Temporary Load | up to 500kg | HOLD021CKF3GVM | \$3462.00 |
| Foam Cell - Permanent Load | up to 500kg | HOLD021DKF3GVM | \$3462.00 |
| Foam Cell Pro - Temporary Load | up to 500kg | HOLD021CKP3GVM | \$3899.00 |
| Foam Cell Pro - Permanent Load | up to 500kg | HOLD021DKP3GVM | \$3899.00 |

POST REGISTRATION - 3500KG
Additional Payload

| | | | |
|--------------------------------|-------------|------------------------|-----------|
| Foam Cell - Temporary Load | up to 500kg | HOLD021CKF3GVM1 | \$3462.00 |
| Foam Cell - Permanent Load | up to 500kg | HOLD021DKF3GVM1 | \$3462.00 |
| Foam Cell Pro - Temporary Load | up to 500kg | HOLD021CKP3GVM1 | \$3899.00 |
| Foam Cell Pro - Permanent Load | up to 500kg | HOLD021DKP3GVM1 | \$3899.00 |

2020-12/2021: Federal Approval VTA-051296 - OE Approval No. VTA-050736

2022+: Federal Approval VTA-060553 - OE Approval No. VTA-051560

- Only available through authorised Ironman 4x4 GVM upgrade installers
- Plus engineering sign off (Post Registration Only)
- Post Registration, State Approval - Vehicle must be inspected and approved by state authorised automotive engineer for issue of modification plate
- GVM orders must be submitted via the GVM Portal

GVM UPGRADE KIT CONTENTS

| | | | |
|-----------------------|----------------------------|------------------------------|--------------------------------------|
| Shock Absorbers | Leaf Springs | Greasable Shackles and Pins | SSM Compliance Plate (pre reg. only) |
| Strut Shock Absorbers | U-Bolts | Brake Hose Extension Bracket | GVM Stickers |
| Coil Springs | Polyurethane Spring Bushes | Tyre Placard | |

GVM Upgrades

Product Description

Part No.

Retail
ea Inc GST

GVM UPGRADE TO SUIT ISUZU D-MAX

2012 TO 7/2019 - (PAGE 102 & 105)

| | Front Axle Rating | Rear Axle Rating | Gross Vehicle Mass (GVM) | Gross Combined Mass (GCM) | Towing Capacity (Braked) |
|--------------------------------|-------------------|------------------|--------------------------|---------------------------|--------------------------|
| Original Equipment (OE) | 1350kg | 1870kg | 2950kg - 3050kg | 5950kg | 3500kg |
| Ironman 4x4 | 1500kg | 2000kg | 3500kg | 5950kg | 3500kg |

These figures are presented as a guide only. Always refer to the owner's manual for load ratings specific to the vehicle

POST REGISTRATION - 3500KG

Additional Payload

| | | | |
|--------------------------------|-------------|------------------------|-----------|
| Foam Cell - Temporary Load | up to 550kg | HOLD021CKF1GVM1 | \$3462.00 |
| Foam Cell - Permanent Load | up to 550kg | HOLD021DKF1GVM1 | \$3462.00 |
| Foam Cell Pro - Temporary Load | up to 550kg | HOLD021CKP1GVM1 | \$3899.00 |
| Foam Cell Pro - Permanent Load | up to 550kg | HOLD021DKP1GVM1 | \$3899.00 |

Federal Approval VTA-049748 - OE Approval No. VTA-043971

- Only available through authorised Ironman 4x4 GVM upgrade installers
- Plus engineering sign off (Post Registration Only)
- Post Registration, State Approval - Vehicle must be inspected and approved by state authorised automotive engineer for issue of modification plate
- GVM orders must be submitted via the GVM Portal

GVM UPGRADE KIT CONTENTS

| | | | |
|-----------------------|----------------------------|------------------------------|--------------|
| Shock Absorbers | Leaf Springs | Greasable Shackles and Pins | GVM Stickers |
| Strut Shock Absorbers | U-Bolts | Brake Hose Extension Bracket | |
| Coil Springs | Polyurethane Spring Bushes | Tyre Placard | |

GVM UPGRADE TO SUIT MAZDA BT50

6/2020-12/2021 - (PAGE 148) | 6/2022+ - (PAGE 148)

| | Front Axle Rating | Rear Axle Rating | Gross Vehicle Mass (GVM) | Gross Combined Mass (GCM) | Towing Capacity (Braked) |
|--------------------------------|-------------------|------------------|--------------------------|---------------------------|--------------------------|
| Original Equipment (OE) | 1450kg | 1910kg | 3100kg | 5950kg | 3500kg |
| Ironman 4x4 | 1500kg | 2000kg | 3500kg | 5950kg | 3500kg |

These figures are presented as a guide only. Always refer to the owner's manual for load ratings specific to the vehicle

PRE REGISTRATION - 3500KG
Additional Payload

| | | | |
|--------------------------------|-------------|-----------------------|-----------|
| Foam Cell - Temporary Load | up to 500kg | HOLD021CKF3GVM | \$3462.00 |
| Foam Cell - Permanent Load | up to 500kg | HOLD021DKF3GVM | \$3462.00 |
| Foam Cell Pro - Temporary Load | up to 500kg | HOLD021CKP3GVM | \$3899.00 |
| Foam Cell Pro - Permanent Load | up to 500kg | HOLD021DKP3GVM | \$3899.00 |

POST REGISTRATION - 3500KG
Additional Payload

| | | | |
|--------------------------------|-------------|------------------------|-----------|
| Foam Cell - Temporary Load | up to 500kg | HOLD021CKF3GVM1 | \$3462.00 |
| Foam Cell - Permanent Load | up to 500kg | HOLD021DKF3GVM1 | \$3462.00 |
| Foam Cell Pro - Temporary Load | up to 500kg | HOLD021CKP3GVM1 | \$3899.00 |
| Foam Cell Pro - Permanent Load | up to 500kg | HOLD021DKP3GVM1 | \$3899.00 |

6/2020-12/2021: Federal Approval VTA-051465 - OE Approval No. VTA-050871

2022+: Federal Approval VTA-060620 - OE Approval No. VTA-051650

- Only available through authorised Ironman 4x4 GVM upgrade installers
- Plus engineering sign off (Post Registration Only)
- Post Registration, State Approval - Vehicle must be inspected and approved by state authorised automotive engineer for issue of modification plate
- GVM orders must be submitted via the GVM Portal

GVM UPGRADE KIT CONTENTS

| | | | |
|-----------------------|----------------------------|-----------------------------|--------------------------------------|
| Shock Absorbers | Leaf Springs | Greasable Shackles and Pins | SSM Compliance Plate (pre reg. only) |
| Strut Shock Absorbers | U-Bolts | Brake Hose Relocation Kit | GVM Stickers |
| Coil Springs | Polyurethane Spring Bushes | Tyre Placard | |

GVM Upgrades

Product Description

Part No.

Retail
ea Inc GST

GVM UPGRADE TO SUIT SUZUKI JIMNY

GJ 2018+ - (PAGE 255)

| | Front Axle Rating | Rear Axle Rating | Gross Vehicle Mass (GVM) | Gross Combined Mass (GCM) | Towing Capacity (Braked) |
|--------------------------------|-------------------|------------------|--------------------------|---------------------------|--------------------------|
| Original Equipment (OE) | 680kg | 880kg | 1435kg | 2735kg | 1300kg |
| Ironman 4x4 | 800kg | 1100kg | 1785kg | 2735kg | 1300kg |

These figures are presented as a guide only. Always refer to the owner's manual for load ratings specific to the vehicle

PRE REGISTRATION - 1785KG

Additional Payload

| | | | |
|----------------------------|-------------|---------------------|-----------|
| Nitro Gas - Temporary Load | up to 350kg | SUZ010BKGGMV | \$2588.00 |
| Nitro Gas - Permanent Load | up to 350kg | SUZ010CKGGMV | \$2588.00 |

POST REGISTRATION - 1785KG

Additional Payload

| | | | |
|----------------------------|-------------|----------------------|-----------|
| Nitro Gas - Temporary Load | up to 350kg | SUZ010BKGGMV1 | \$2588.00 |
| Nitro Gas - Permanent Load | up to 350kg | SUZ010CKGGMV1 | \$2588.00 |

Federal Approval VTA-050688 - OE Approval No. VTA-049434

- Only available through authorised Ironman 4x4 GVM upgrade installers
- Plus engineering sign off (Post Registration Only)
- Post Registration, State Approval - Vehicle must be inspected and approved by state authorised automotive engineer for issue of modification plate
- GVM orders must be submitted via the GVM Portal

GVM UPGRADE KIT CONTENTS

| | | | |
|---------------------------------|-----------------------------------|--------------------------------------|--------------|
| Shock Absorbers | Offset Bush Kit Rubber | Extended Bump Stop | GVM Stickers |
| Coil Springs | Extended Brake Hose | Tyre Placard | |
| Front Crossmember Drop Brackets | Extended Headlight Sensor Bracket | SSM Compliance Plate (pre reg. only) | |

GVM UPGRADE TO SUIT TOYOTA HILUX

2015+ - (PAGE 280 & 284)

| | Front Axle Rating | Rear Axle Rating | Gross Vehicle Mass (GVM) | Gross Combined Mass (GCM) | Towing Capacity (Braked) |
|--------------------------------|-------------------|------------------|--------------------------|---------------------------|--------------------------|
| Original Equipment (OE) | 1450kg | 1700kg | 3050kg | 5850kg | 3500kg |
| Ironman 4x4 (3500kg) | 1510kg | 2000kg | 3500kg | 5850kg | 3500kg |
| Ironman 4x4 (3510kg) | 1510kg | 2000kg | 3510kg | 5850kg | 3500kg |

These figures are presented as a guide only. Always refer to the owner's manual for load ratings specific to the vehicle

PRE REGISTRATION - 3500KG
Additional Payload

| | | | |
|--------------------------------|-------------|----------------------|-----------|
| Foam Cell - Temporary Load | up to 500kg | TOY077CKF1GVM | \$3366.00 |
| Foam Cell - Permanent Load | up to 500kg | TOY077DKF1GVM | \$3366.00 |
| Foam Cell Pro - Temporary Load | up to 500kg | TOY077CKP1GVM | \$3940.00 |
| Foam Cell Pro - Permanent Load | up to 500kg | TOY077DKP1GVM | \$3940.00 |

POST REGISTRATION - 3500KG
Additional Payload

| | | | |
|--------------------------------|-------------|-----------------------|-----------|
| Foam Cell - Temporary Load | up to 500kg | TOY077CKF1GVM1 | \$3366.00 |
| Foam Cell - Permanent Load | up to 500kg | TOY077DKF1GVM1 | \$3366.00 |
| Foam Cell Pro - Temporary Load | up to 500kg | TOY077CKP1GVM1 | \$3940.00 |
| Foam Cell Pro - Permanent Load | up to 500kg | TOY077DKP1GVM1 | \$3940.00 |

PRE REGISTRATION - 3510KG
Additional Payload

| | | | |
|--------------------------------|-------------|---------------------|-----------|
| Foam Cell - Temporary Load | up to 510kg | TOY077CKFGVM | \$3462.00 |
| Foam Cell - Permanent Load | up to 510kg | TOY077DKFGVM | \$3462.00 |
| Foam Cell Pro - Temporary Load | up to 510kg | TOY077CKPGVM | \$4035.00 |
| Foam Cell Pro - Permanent Load | up to 510kg | TOY077DKPGVM | \$4035.00 |

POST REGISTRATION - 3510KG
Additional Payload

| | | | |
|--------------------------------|-------------|----------------------|-----------|
| Foam Cell - Temporary Load | up to 510kg | TOY077CKFGVM1 | \$3462.00 |
| Foam Cell - Permanent Load | up to 510kg | TOY077DKFGVM1 | \$3462.00 |
| Foam Cell Pro - Temporary Load | up to 510kg | TOY077CKPGVM1 | \$4035.00 |
| Foam Cell Pro - Permanent Load | up to 510kg | TOY077DKPGVM1 | \$4035.00 |

Federal Approval VTA-050749 (3500kg GVM) - OE Approval No. VTA-047341

Federal Approval VTA-048310 (3510kg GVM) - OE Approval No. VTA-047341

- Only available through authorised Ironman 4x4 GVM upgrade installers
- Plus engineering sign off (Post Registration Only)
- Post Registration, State Approval - Vehicle must be inspected and approved by state authorised automotive engineer for issue of modification plate
- GVM orders must be submitted via the GVM Portal

GVM UPGRADE KIT CONTENTS

| | | | |
|-----------------------|----------------------------|--------------------------------------|--------------------------------------|
| Shock Absorbers | Leaf Springs | Greasable Shackles | Tyre Placard |
| Strut Shock Absorbers | U-Bolts | Non-Greasable Pin Kit | SSM Compliance Plate (pre reg. only) |
| Coil Springs | Polyurethane Spring Bushes | Cat. 6 Side Indicators (3510kg only) | GVM Stickers |

GVM Upgrades

Product Description

Part No.

Retail
ea Inc GST

GVM UPGRADE TO SUIT TOYOTA HILUX

2005 TO 2015 - (PAGE 287)

| | Front Axle Rating | Rear Axle Rating | Gross Vehicle Mass (GVM) | Gross Combined Mass (GCM) | Towing Capacity (Braked) |
|--------------------------------|------------------------------|------------------------------|--------------------------|------------------------------|--------------------------|
| Original Equipment (OE) | 1240kg - 1340kg ¹ | 1520kg - 1600kg ² | 2850kg | 4600kg - 4750kg ³ | 3200kg |
| Ironman 4x4 | 1540kg | 1810kg | 3350kg | 4600kg - 4750kg ³ | 3200kg |

¹ Front axle updated 4 times

² Single Cab and Double Cab 1600kg, Extra Cab 1520kg

³ 1GR-FE 4750kg, 2TR-FE 4600kg

These figures are presented as a guide only. Always refer to the owner's manual for load ratings specific to the vehicle

POST REGISTRATION - 3350KG

Additional Payload

| | | | |
|--------------------------------|-------------|----------------------|-----------|
| Foam Cell - Temporary Load | up to 500kg | TOY057CKFGVM1 | \$3281.00 |
| Foam Cell - Permanent Load | up to 500kg | TOY057DKFGVM1 | \$3281.00 |
| Foam Cell Pro - Temporary Load | up to 500kg | TOY057CKPGVM1 | \$3813.00 |
| Foam Cell Pro - Permanent Load | up to 500kg | TOY057DKPGVM1 | \$3813.00 |

Federal Approval VTA-044780 - OE Approval No. VTA-033886

- Only available through authorised Ironman 4x4 GVM upgrade installers
- Plus engineering sign off (Post Registration Only)
- Post Registration, State Approval - Vehicle must be inspected and approved by state authorised automotive engineer for issue of modification plate
- GVM orders must be submitted via the GVM Portal

GVM UPGRADE KIT CONTENTS

| | | |
|-----------------------|----------------------------|-----------------------------|
| Shock Absorbers | Leaf Springs | Greasable Shackles and Pins |
| Strut Shock Absorbers | U-Bolts | Tyre Placard |
| Coil Springs | Polyurethane Spring Bushes | GVM Stickers |

GVM UPGRADE TO SUIT TOYOTA LANDCRUISER

200 SERIES MC 2007+ - (PAGE 296) | 200 SERIES NA 2007+ - (PAGE 296)

| | Front Axle Rating | Rear Axle Rating | Gross Vehicle Mass (GVM) | Gross Combined Mass (GCM) | Towing Capacity (Braked) |
|--------------------------------|--|------------------|--|---------------------------|--------------------------|
| Original Equipment (OE) | 1630kg ¹ 1700kg ¹ | 1950kg | 3300kg ² 3350kg ² | 6850kg | 3500kg 3550kg |
| Ironman 4x4 | 1800kg | 2250kg | 3580kg 4000kg | 6850kg | 3500kg 3550kg |

¹ Front axle upgraded January 2012

² GVM upgraded January 2012

These figures are presented as a guide only. Always refer to the owner's manual for load ratings specific to the vehicle

PRE REGISTRATION - 4000KG

Additional Payload

| | | | |
|-------------------------------|-------------|-------------------------|-----------|
| Foam Cell Pro - MC Compliance | up to 700kg | TOY063CKPGVM-MC | \$2988.00 |
| Foam Cell Pro - NA Compliance | up to 700kg | TOY063CKPGVM-NB1 | \$3178.00 |

Federal Approval - (MC) VTA-050517 and (NB1) VTA-050503 - OE Approval No. MC-38469 and NA-43656

POST REGISTRATION - 4000KG

Additional Payload

| | | | |
|-------------------------------|-------------|--------------------------|-----------|
| Foam Cell Pro - MC Compliance | up to 700kg | TOY063CKPGVM1-MC | \$2988.00 |
| Foam Cell Pro - NA Compliance | up to 700kg | TOY063CKPGVM1-NB1 | \$3178.00 |

Federal Approval (MC) VTA-050517 and (NB1) VTA-050503 - OE Approval No. MC VTA-038469 and NA VTA-043656

POST REGISTRATION - 3580KG

Additional Payload

| | | | |
|--------------------------------|-------------|----------------------|-----------|
| Foam Cell Pro - Temporary Load | up to 280kg | TOY063BKPGVM1 | \$2717.00 |
|--------------------------------|-------------|----------------------|-----------|

• Only available through authorised Ironman 4x4 GVM upgrade installers

• Plus engineering sign off (Post Registration Only)

• Post Registration, State Approval - Vehicle must be inspected and approved by state authorised automotive engineer for issue of modification plate

• Upgrades NA vehicles to NB1 category (fitment of Cat. 6 side indicator lamps required)

• GVM orders must be submitted via the GVM Portal

GVM UPGRADE KIT CONTENTS

| | | | |
|-----------------------|---|--------------------------------------|--------------|
| Shock Absorbers | Coil Springs | Tyre Placard | GVM Stickers |
| Strut Shock Absorbers | Cat. 6 Side Indicators (NA-NB1 vehicles only) | SSM Compliance Plate (pre reg. only) | |

GVM Upgrades

Product Description

Part No.

Retail
ea Inc GST

GVM UPGRADE TO SUIT TOYOTA LANDCRUISER

79 SERIES SINGLE CAB 2007 TO 11/2022 - (PAGE 309)

| | Front Axle Rating | Rear Axle Rating | Gross Vehicle Mass (GVM) | Gross Combined Mass (GCM) | Towing Capacity (Braked) |
|--------------------------------|-------------------|------------------|--------------------------|---------------------------|--------------------------|
| Original Equipment (OE) | 1480kg | 2300kg | 3400kg | 6900kg | 3500kg |
| Ironman 4x4 | 1550kg | 2800kg | 3900kg | 6900kg | 3500kg |

These figures are presented as a guide only. Always refer to the owner's manual for load ratings specific to the vehicle

PRE REGISTRATION - 3900KG

Additional Payload

| | | | |
|--------------------------------|-------------|---------------------|-----------|
| Foam Cell - Temporary Load | up to 600kg | TOY047CKFGVM | \$3813.00 |
| Foam Cell - Frequent Load | up to 600kg | TOY047DKFGVM | \$3895.00 |
| Foam Cell - Permanent Load | up to 600kg | TOY047EKFGVM | \$3923.00 |
| Foam Cell Pro - Temporary Load | up to 600kg | TOY047CKPGVM | \$3962.00 |
| Foam Cell Pro - Frequent Load | up to 600kg | TOY047DKPGVM | \$4044.00 |
| Foam Cell Pro - Permanent Load | up to 600kg | TOY047EKPGVM | \$4071.00 |

POST REGISTRATION - 3900KG

Additional Payload

| | | | |
|--------------------------------|-------------|----------------------|-----------|
| Foam Cell - Temporary Load | up to 600kg | TOY047CKFGVM1 | \$3813.00 |
| Foam Cell - Frequent Load | up to 600kg | TOY047DKFGVM1 | \$3895.00 |
| Foam Cell - Permanent Load | up to 600kg | TOY047EKFGVM1 | \$3923.00 |
| Foam Cell Pro - Temporary Load | up to 600kg | TOY047CKPGVM1 | \$3962.00 |
| Foam Cell Pro - Frequent Load | up to 600kg | TOY047DKPGVM1 | \$4044.00 |
| Foam Cell Pro - Permanent Load | up to 600kg | TOY047EKPGVM1 | \$4071.00 |

Federal Approval VTA-045466 - OE Approval No. VTA-003477

- Only available through authorised Ironman 4x4 GVM upgrade installers
- Plus engineering sign off (Post Registration Only)
- Post Registration, State Approval - Vehicle must be inspected and approved by state authorised automotive engineer for issue of modification plate
- GVM orders must be submitted via the GVM Portal

GVM UPGRADE KIT CONTENTS

| | | | |
|-----------------|-----------------------------|-----------------------------|--------------------------------------|
| Shock Absorbers | U-Bolts | Extended Brake Hose | Tyre Placard |
| Coil Springs | Polyurethane Spring Bushes | C Washer to Suit Brake Hose | SSM Compliance Plate (pre reg. only) |
| Leaf Springs | Greasable Shackles and Pins | Cat. 6 Side Indicators | GVM Stickers |

Product Description

Part No.

Retail
ea Inc GST

GVM UPGRADE TO SUIT TOYOTA LANDCRUISER

79 SERIES DUAL CAB 2012 TO 11/2022 - (PAGE 312)

| | Front Axle Rating | Rear Axle Rating | Gross Vehicle Mass (GVM) | Gross Combined Mass (GCM) | Towing Capacity (Braked) |
|--------------------------------|-------------------|------------------|--------------------------|---------------------------|--------------------------|
| Original Equipment (OE) | 1480kg | 2300kg | 3300kg | 6800kg | 3500kg |
| Ironman 4x4 | 1550kg | 2800kg | 3900kg | 6800kg | 3500kg |

These figures are presented as a guide only. Always refer to the owner's manual for load ratings specific to the vehicle

PRE REGISTRATION - 3900KG

Additional Payload

| | | | |
|--------------------------------|-------------|---------------------|-----------|
| Foam Cell - Temporary Load | up to 600kg | TOY047CKFGVM | \$3813.00 |
| Foam Cell - Frequent Load | up to 600kg | TOY047DKFGVM | \$3895.00 |
| Foam Cell - Permanent Load | up to 600kg | TOY047EKFGVM | \$3923.00 |
| Foam Cell Pro - Temporary Load | up to 600kg | TOY047CKPGVM | \$3962.00 |
| Foam Cell Pro - Frequent Load | up to 600kg | TOY047DKPGVM | \$4044.00 |
| Foam Cell Pro - Permanent Load | up to 600kg | TOY047EKPGVM | \$4071.00 |

POST REGISTRATION - 3900KG

Additional Payload

| | | | |
|--------------------------------|-------------|----------------------|-----------|
| Foam Cell - Temporary Load | up to 600kg | TOY047CKFGVM1 | \$3813.00 |
| Foam Cell - Frequent Load | up to 600kg | TOY047DKFGVM1 | \$3895.00 |
| Foam Cell - Permanent Load | up to 600kg | TOY047EKFGVM1 | \$3923.00 |
| Foam Cell Pro - Temporary Load | up to 600kg | TOY047CKPGVM1 | \$3962.00 |
| Foam Cell Pro - Frequent Load | up to 600kg | TOY047DKPGVM1 | \$4044.00 |
| Foam Cell Pro - Permanent Load | up to 600kg | TOY047EKPGVM1 | \$4071.00 |

Federal Approval VTA-045466 - OE Approval No. VTA-003477

- Only available through authorised Ironman 4x4 GVM upgrade installers
- Plus engineering sign off (Post Registration Only)
- Post Registration, State Approval - Vehicle must be inspected and approved by state authorised automotive engineer for issue of modification plate
- GVM orders must be submitted via the GVM Portal

GVM UPGRADE KIT CONTENTS

| | | | |
|-----------------|-----------------------------|-----------------------------|--------------------------------------|
| Shock Absorbers | U-Bolts | Extended Brake Hose | Tyre Placard |
| Coil Springs | Polyurethane Spring Bushes | C Washer to Suit Brake Hose | SSM Compliance Plate (pre reg. only) |
| Leaf Springs | Greasable Shackles and Pins | Cat. 6 Side Indicators | GVM Stickers |

GVM Upgrades

Product Description

Part No.

Retail
ea Inc GST

GVM UPGRADE TO SUIT TOYOTA LANDCRUISER

78 SERIES TROOP CARRIER 2007 TO 11/2022 - (PAGE 316)

| | Front Axle Rating | Rear Axle Rating | Gross Vehicle Mass (GVM) | Gross Combined Mass (GCM) | Towing Capacity (Braked) |
|--------------------------------|-------------------|------------------|--------------------------|---------------------------|--------------------------|
| Original Equipment (OE) | 1480kg | 2300kg | 3300kg | 6800kg | 3500kg |
| Ironman 4x4 | 1550kg | 2800kg | 3900kg | 6800kg | 3500kg |

These figures are presented as a guide only. Always refer to the owner's manual for load ratings specific to the vehicle

PRE REGISTRATION - 3900KG

Additional Payload

| | | | |
|--------------------------------|-------------|---------------------|-----------|
| Foam Cell - Temporary Load | up to 600kg | TOY047CKFGVM | \$3813.00 |
| Foam Cell - Frequent Load | up to 600kg | TOY047DKFGVM | \$3895.00 |
| Foam Cell - Permanent Load | up to 600kg | TOY047EKFGVM | \$3923.00 |
| Foam Cell Pro - Temporary Load | up to 600kg | TOY047CKPGVM | \$3962.00 |
| Foam Cell Pro - Frequent Load | up to 600kg | TOY047DKPGVM | \$4044.00 |
| Foam Cell Pro - Permanent Load | up to 600kg | TOY047EKPGVM | \$4071.00 |

POST REGISTRATION - 3900KG

Additional Payload

| | | | |
|--------------------------------|-------------|----------------------|-----------|
| Foam Cell - Temporary Load | up to 600kg | TOY047CKFGVM1 | \$3813.00 |
| Foam Cell - Frequent Load | up to 600kg | TOY047DKFGVM1 | \$3895.00 |
| Foam Cell - Permanent Load | up to 600kg | TOY047EKFGVM1 | \$3923.00 |
| Foam Cell Pro - Temporary Load | up to 600kg | TOY047CKPGVM1 | \$3962.00 |
| Foam Cell Pro - Frequent Load | up to 600kg | TOY047DKPGVM1 | \$4044.00 |
| Foam Cell Pro - Permanent Load | up to 600kg | TOY047EKPGVM1 | \$4071.00 |

Federal Approval VTA-045466 - OE Approval No. VA-003477

- Only available through authorised Ironman 4x4 GVM upgrade installers
- Plus engineering sign off (Post Registration Only)
- Post Registration, State Approval - Vehicle must be inspected and approved by state authorised automotive engineer for issue of modification plate
- GVM orders must be submitted via the GVM Portal

GVM UPGRADE KIT CONTENTS

| | | | |
|-----------------|-----------------------------|-----------------------------|--------------------------------------|
| Shock Absorbers | U-Bolts | Extended Brake Hose | Tyre Placard |
| Coil Springs | Polyurethane Spring Bushes | C Washer to Suit Brake Hose | SSM Compliance Plate (pre reg. only) |
| Leaf Springs | Greasable Shackles and Pins | Cat. 6 Side Indicators | GVM Stickers |

Suspension Selection and Information

Effective 1 December 2022



Understanding Load

Suspension is not something you often see when you first look at a vehicle. But when you need it, suspension can be the single most important upgrade you make. Original equipment suspension is set up to support your vehicle for on-road conditions with a reasonable amount of weight.

When you start to add vehicle accessories, attach a trailer or caravan and increase your load, the way the suspension handles the load changes. Couple that with uneven surfaces and off-road conditions, the OEM suspension can no longer take the additional strain.

LOAD DISTRIBUTION

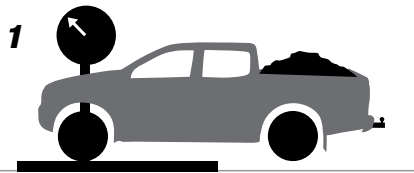

1
Load placed over the front half of the vehicle determines front spring selection
Ensure total weight does not exceed manufacturers axle load limit



2
Load placed over the rear half of the vehicle determines rear spring selection
Ensure total weight does not exceed manufacturers axle load limit



3
 $1 + 2 =$ Total weight of vehicle
Ensure total weight does not exceed manufacturers GVM (gross vehicle mass)

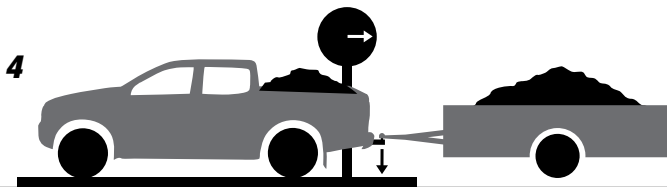

4
Vehicle with trailer connected minus total weight of vehicle = Ball weight
Ensure total weight of vehicle including ball weight does not exceed manufacturers GVM

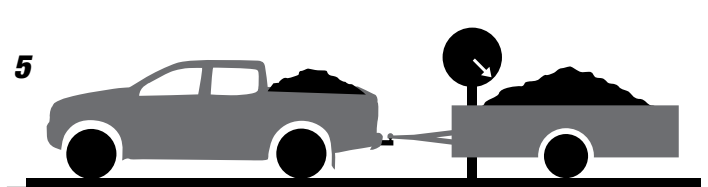

5
Total weight of vehicle plus trailer weight = GCM (gross combined mass)
Ensure total weight of vehicle and trailer does not exceed manufacturers GCM

Please note: Not all springs are available in green and some may be supplied in yellow. Please check before ordering.



Determining Load

STEP ONE LOAD?

When your load changes, so should your springs.

Any heavy accessories or towing load added to your vehicle, changes the handling and overall safety when driving. The vehicle's springs must be matched to the load for optimum ride height and body control. Ironman 4x4 offer a range of springs to match the additional loads whether they are constant or temporary.

When you start kitting out your vehicle, take into consideration the kerb weight and how much load you are adding, this will change what level of strength you need. Remember, you cannot exceed your GVM, but you might be able to upgrade it. (See page 363 for GVM upgrade information)

Ironman 4x4 offer a range of springs matched to cater for every load scenario. To identify your spring type, start by finding your kerb weight and add your load, permanent and temporary. How much load have you added to your vehicle?

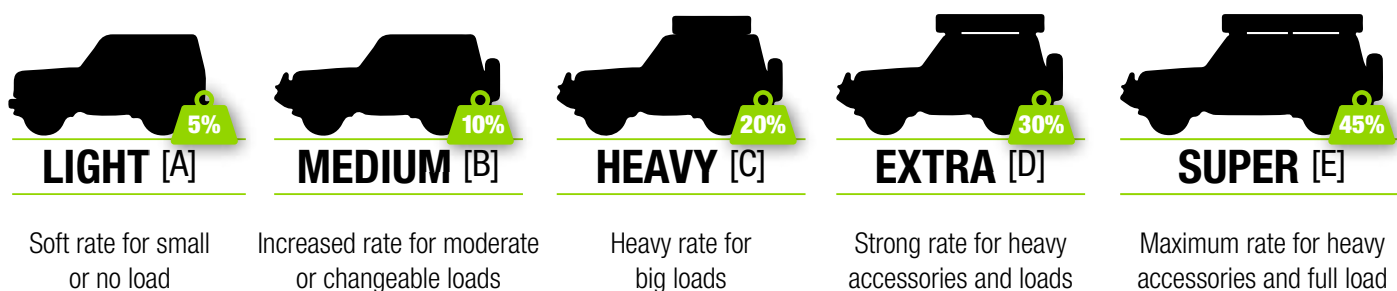

PART NUMBER SUFFIX S - Standard Height (eg. TOY063S)

Available for selected applications to provide enhanced performance at original vehicle manufacturers ride height.

PART NUMBER SUFFIX A - Light (eg. TOY047A)

Suitable for zero to light load applications, higher priority toward - Comfort with minimal increased ride height.

PART NUMBER SUFFIX B - Medium (eg. TOY047B)

Suitable for use in zero to medium load applications, ideal for moderately accessorised vehicles or occasional load.

PART NUMBER SUFFIX C - Heavy (eg. TOY047C)

Suitable for vehicles with permanent heavy accessories, higher priority towards load support, provides more control and firmer suspension.

PART NUMBER SUFFIX D - Extra Heavy (eg. TOY047D)

Suited only to vehicles with permanent heavy accessories combined with heavy additional load.

PART NUMBER SUFFIX E - Super Heavy (eg. TOY047E)

Maximum support for extra heavy loads typically commercial or mining use vehicles.

All lift heights quoted within this catalogue are general estimates only, relative to new vehicle ride height. Suggested lifts are based upon the lighter of the recommended additional load. The position of added weight can affect the result.

Understanding Terrain

STEP TWO TERRAIN?

The terrain you travel most, determines what type of shock absorber is right for you! Forces generated by a loaded vehicle in rough terrain versus a lightly loaded vehicle in smooth terrain differ greatly and can be considerably higher.

Creating safe and appropriate dynamic handling at higher than original weights requires careful consideration. The range of Ironman 4x4 shock absorbers are designed to cover all terrains and possess the correct amount of damping resistance to provide a safe and comfortable ride.

Easy Terrain



NITRO GAS



Nitro Gas

The Nitro Gas shock is the best value for affordable performance in all common conditions.

Highly versatile, the shock is a big step up above OEM suspension in performance and control.

- 35mm piston
- 54mm body
- 16mm piston rod
- Twin tube construction
- Nitrogen gas pressurised

Adventurous Terrain



FOAM CELL



Foam Cell

The Foam Cell shock will enhance your off-road durability and performance while still maintaining excellent on-road characteristics.

Excels in off-road conditions where heat build-up is a concern, the Foam Cell shock is larger in size and holds more oil, providing a better dissipation of heat and longer lasting performance in all terrains.

- 40mm piston
- 60mm body
- 18mm piston rod
- Twin tube construction
- Foam cell technology

Demanding Terrain



FOAM CELL PRO



Foam Cell Pro

Foam Cell Pro shock, the premium shock, built to handle anything.

Originally designed to meet the demands of the armoured vehicle industry where reliability and durability are critical.

Foam Cell Pro is the ultimate shock when the going gets tough. Thicker and stronger than any other shock on the market, it's well suited to trades, fleet and serious off-roaders.

- 45mm piston
- 65-72mm body
- 20mm piston rod
- 3mm wall thickness
- Twin tube construction
- Foam cell technology



Understanding Valving

STEP THREE

RIDE STYLE?

Your preferred ride style is important to know when selecting the level of valving resistance in your shock absorbers. Ironman 4x4 shock absorbers adapt to the velocity of the compression and rebound stroke which provides the right amount of control to suit your driving style.

Comfort Valving

GRC FEC FEC^{PRO}

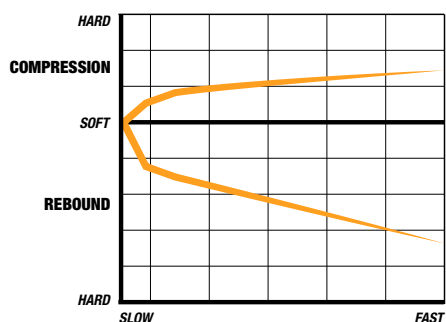

Soft Ride - Lightly Accessorised

The comfort range delivers smooth handling and less harshness for everyday use. Best suited to lighter vehicles without load, the shocks prioritise a soft comfortable ride, above all else.

Performance Valving

GR FE FE^{PRO}

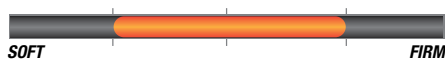
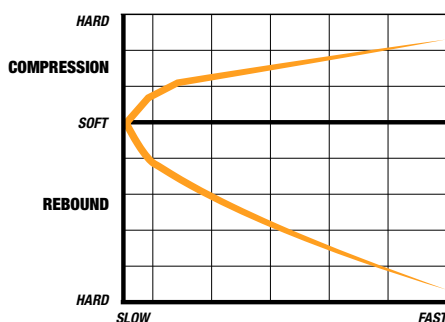

Versatile Ride - Moderately Accessorised

The performance range adapts to a wide range of driving styles. Best suited to moderately loaded vehicles with some accessories, the shocks provide a balanced comfortable ride with more control.

Professional Valving

GRP FEP FEP^{PRO}

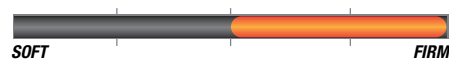
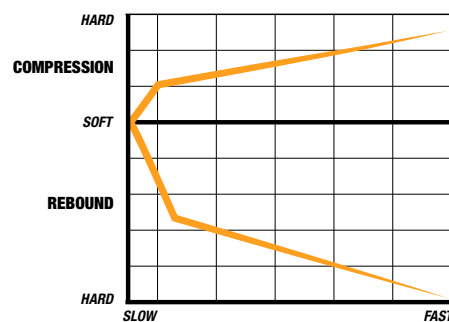

Strong Controlled Ride - Heavily Accessorised

The professional range controls body roll and reduces pitching while driving over all terrains. Best suited to heavily loaded vehicles with a higher centre of gravity, the shocks focus on maximising control and stability.



Understanding GVM Upgrades

GVM UPGRADE REQUIRED?

If loads exceed the axle limits or gross vehicle mass (GVM) stated by the original vehicle manufacturer, a certified increase in GVM will be required.





















Ironman 4x4 design and manufacture a range of approved GVM upgrades for a selection of vehicles, which comply with federal and state regulations (Australia and NZ Only). See pages 373 -386 of this catalogue.

Comprehensive testing is conducted by Ironman 4x4 and independent engineers to ensure maximum safety, performance and ADR compliance at the increased load carrying capacity.

Ironman 4x4 has obtained Second Stage Manufacturer (SSM) status through the Department of Infrastructure Regional Development and Cities in Canberra GVM Upgrades are available through selected Ironman 4x4 Australian and NZ distributors only.

ADDITIONAL LOAD

Use the below guide to estimate the additional load in the vehicle. Calculate the load separated over each axle to determine the nearest spring selection based on the recommendations given within the vehicle application pages. Please Note: Weights quoted below are supplied as an approximate guide only.

| | |
|---|--|
| Bull Bar Aluminium  +40kg | Fuel Tank Extended Capacity  +90kg |
| Bull Bar Steel  +60kg | Roof Rack Steel 2200mm Tent Rack  +45kg |
| Winch With Synthetic Rope  +25kg | Rooftop Tent Including bedding  +65kg |
| Winch With Steel Cable  +45kg | Water Tank 100 Litres  +100kg |
| Spare Wheel Additional  +50kg | Tray -100kg Aluminium  |
| Rear Bar Steel  +65kg | Tray Steel  +400kg |
| Canopy ABS Plastic  +80kg | Tool Box Average  +100kg |
| Drawer System 1300mm Twin Drawers  +90kg | Passenger Average  +80kg |
| Battery Additional  +25kg | Luggage  +100-300kg |
| Fridge 50 Litre  +30kg | Towing  +100-300kg |
| | Large Overhang +30%  |

Vehicles with large rear overhang such as tray or service bodies may amplify loads by approximately 30%.

Suspension Kits and Correct Selection

Ironman 4x4 suspension kits are a simplified way to select the appropriate components for a vehicle. Many vehicles have different suspension requirements according to added load, terrain and driver preferences.

To establish the correct suspension kit, we ask the following questions:

- 1) What is the primary usage of the vehicle?
- 2) What accessories are on the vehicle?
- 3) What additional loads are within the vehicle and how often are the loads present?
- 4) What is the primary driving terrain?

The Ironman 4x4 suspension kit part numbering system is designed to be read as follows:

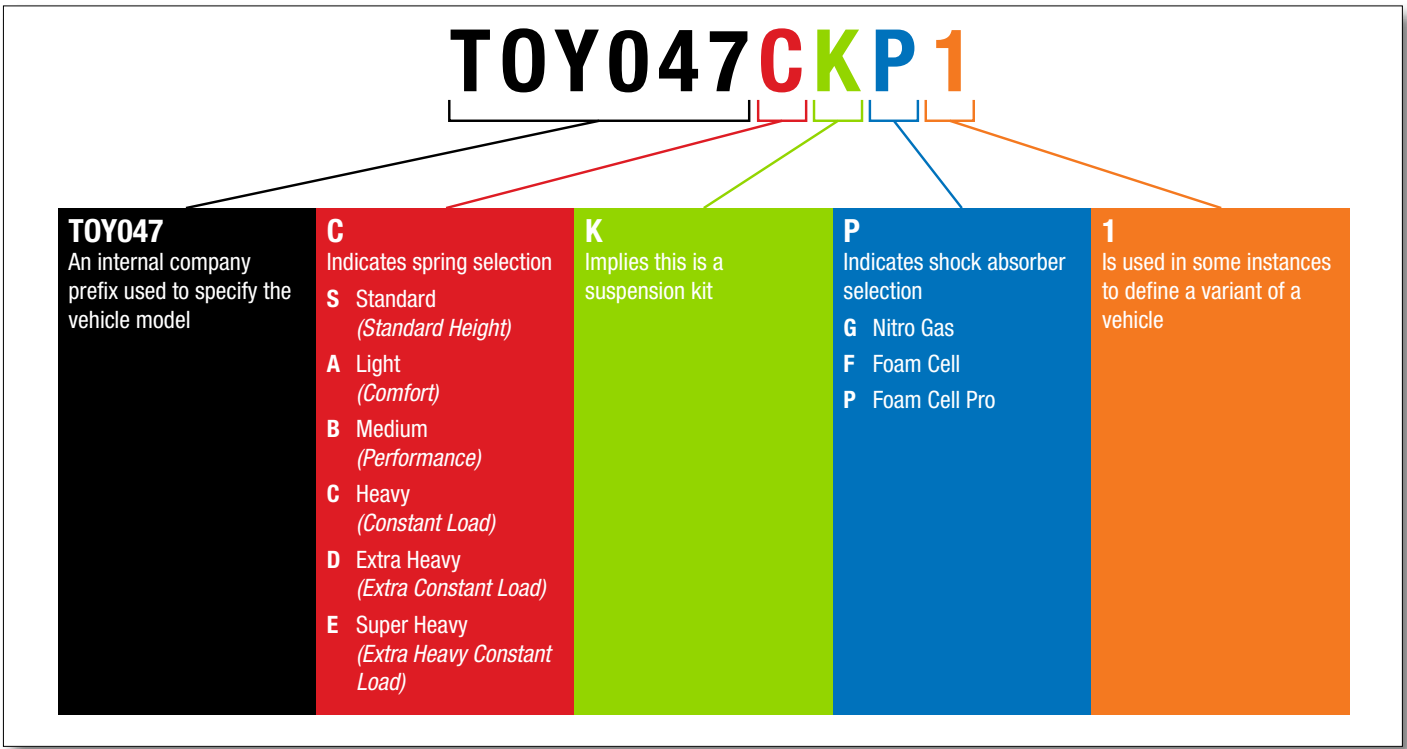

Generally, as no two vehicles are alike, customising a suspension kit is recommended and can be discussed with the Ironman 4x4 team.

For example, a vehicle with heavy load over the rear axle only, does not require constant load front springs, in this case a lighter front spring and heavier rear spring is the best choice.



Application Guide - Shock Absorbers To Suit

| To Suit Make | To Suit Model | Year | Nitro Gas | | Foam Cell | | Foam Cell Pro | |
|----------------------------|--|-----------------|--------------------------|---------------|-----------|---------------|---------------|---------------|
| | | | Front | Rear | Front | Rear | Front | Rear |
| TO SUIT FIAT | Fullback | 2016+ | 12715GR | 12729GR /C /P | 24715FE | 24729FE /C /P | | |
| TO SUIT FORD | Courier / Ranger | 1985 - 2011 | 12667GR | 12095GR /C | 24667FE | 24095FE /C /P | 45667FE | 45095FE /C /P |
| | Everest UA | 2015 - 6/2018 | 12727GR | 12732GR | 24727FE | 24732FE | 45727FE | 45732FE |
| | Everest UA II | 7/2018+ | 12827GR | 12732GR | 24827FE | 24732FE | 45827FE | 45732FE |
| | Ranger T6 PX / PXII | 2011 - 6/2018 | 12727GR | 12095GR /C | 24727FE | 24095FE /C /P | 45727FE | 45095FE /C /P |
| | Ranger PXIII (Not US Model) | 7/2018+ | 12827GR | 12095GR /C | 24827FE | 24095FE /C /P | 45827FE | 45095FE /C /P |
| TO SUIT GMC | Suburban, Tahoe, Sierra, Yukon, Avalanche, Silverado | 2007 - 2013 | 12807GR | 12808GR | | | | |
| | Suburban, Escalade, Tahoe, Sierra, Yukon, Silverado | 2014 - 2016 | 12809GR | 12810GR | | | | |
| TO SUIT GREAT WALL | Cannon | 9/2020+ | 12853GR | 12095GR /C | 24853FE | 24095FE /C /P | 45853FE | 45095FE /C /P |
| TO SUIT HAVAL | H9 Wagon | 8/2017+ | 12710GR | 12804GR | 24710FE | 24804FE | | |
| TO SUIT HOLDEN / GM | Frontera | 1995 - 1/1999 | 12667GR | 12644GR | 24667FE | 24644FE | | |
| | Rodeo KB - TF | 1983 - 1988 | 12087GR | 12636GR /C /P | 24087FE | 24636FE /C /P | | |
| | Rodeo KB - TFS | 1988 - 3/2003 | 12643GR | 12636GR /C /P | | 24636FE /C /P | | |
| | Rodeo / Colorado / RA / RA7 / RC | 2003 - 2012 | 12667GR | 12636GR /C /P | 24667FE | 24636FE /C /P | | |
| | Colorado | 2012 - 2020 | 12745GR | 12636GR /C /P | 24745FE | 24636FE /C /P | 45745FE | 45636FE /C /P |
| | Colorado 7 / Trailblazer | 2012+ | 12745GR | 12746GR /C | 24745FE | 24746GR /C | 45745FE | 45746FE /C |
| | Jackaroo | Pre 1986 | 12087GR | 12636GR /C | 24087FE | 24636FE /C | | |
| | Jackaroo | 11/1986 - 1991 | 12087GR | 12671GR | 24087FE | | | |
| | Jackaroo / Bighorn / Monterey | 1992+ | 12643GR | 12644GR | 24643FE | 24644FE | | |
| TO SUIT HYUNDAI | Terracan | 2001+ | 12087GR | 12637GR /C | 24087FE | | | |
| TO SUIT ISUZU | D-Max | 2003 - 2012 | 12667GR | 12636GR /C /P | 24667FE | 24636FE /C /P | | |
| | D-Max Low Ride 2WD | 2012+ | 12797GR | 12636GR /C /P | | 24636FE /C /P | | |
| | D-Max | 6/2012 - 7/2019 | 12745GR | 12636GR /C /P | 24745FE | 24636FE /C /P | 45745FE | 45636FE /C /P |
| | D-Max | 8/2019+ | 12845GR | 12698GR /C /P | 24845FE | 24698FE /C /P | 45845FE | 45698FE /C /P |
| | MU-X | 2013 - 7/2021 | 12745GR | 12746GR /C | 24745FE | 24746GR /C | 45745FE | 45746FE /C |
| | MU-X | 8/2021+ | 12845GR | 12746GR /C | 24845FE | 24746GR /C | 45845FE | 45746FE /C |
| | Trooper | Pre 1986 | 12087GR | 12636GR /C | 24087FE | 24636FE /C | | |
| | Trooper | 11/1986 - 1991 | 12087GR | 12671GR | 24087FE | | | |
| | Monterey | 1992+ | 12643GR | 12644GR | 24643FE | 24644FE | | |
| TO SUIT JEEP | Cherokee XJ | 1984+ | 12665GR | 12666GR | 24665FE | 24666FE | | |
| | Cherokee Liberty KJ / KK | 2001 - 2012 | 12711GR | 12712GR | | | | |
| | Gladiator | 5/2020+ | 12851GR /C | | | | 45851FE /C | 45854FE /C |
| | Grand Cherokee ZJ / ZG | 1993 - 1998 | 12665GR | 12670GR | 24665FE | | | |
| | Grand Cherokee WJ / WG | 1999 - 6/2005 | 12774GR | 12775GR | | | | |
| | Grand Cherokee WK2 | 2011-2016 | 12735GR | | | | | |
| | Grand Cherokee WK2 | 2016+ | 12738GR LH 12738GR RH | | | | | |
| | Wrangler TJ | 1996 - 2/2007 | 12665GR | 12669GR | 24665FE | | | |
| | Wrangler JK | 2006+ | 12751GR | 12752GR | | | 45751FE | 45752FE |
| | Wrangler JK 4" Lift | 2006+ | 12751LGR | 12752LGR | | | 45751LFE | 45752LFE |
| | Wrangler JL | 2018+ | 12851GR /C | 12852GR /C | | | 45851FE /C | 45852FE /C |

/C = Comfort option available. /P = Professional option available. ¹ Bundera / Wrangler LHS ² Bundera / Wrangler RHS ³ 45780FE, Must use Ironman coil springs TOY063



Application Guide - Shock Absorbers To Suit

| To Suit Make | To Suit Model | Year | Nitro Gas | | Foam Cell | | Foam Cell Pro | |
|------------------------------|--|----------------|-----------|---------------|-----------|---------------|---------------|---------------|
| | | | Front | Rear | Front | Rear | Front | Rear |
| TO SUIT JMC | Vigus | 2014+ | 12710GR | 12650GR /C | 24710FE | 24650FE /C /P | 45710FE | 45650FE /C /P |
| TO SUIT LAND ROVER | Defender 90 / 110 / 130 Series | | 12080GR | 12640GR | 24080FE | 24640FE | 45080FE | 45640FE |
| | Range Rover (Coil Springs) | 1971 - 1995 | 12080GR | 12640GR | 24080FE | 24640FE | 45080FE | 45640FE |
| | Discovery Series 1 | 1989 - 1998 | 12080GR | 12640GR | 24080FE | 24640FE | 45080FE | 45640FE |
| | Discovery Series 2 (Coil Springs) | 1999 - 2005 | 12776GR | 12777GR | 24776FE | 24777FE | | |
| TO SUIT LDV | T60 | 2017+ | 12745GR | 12636GR /C /P | 24745FE | 24636FE /C /P | 45745FE | 45636FE /C /P |
| TO SUIT MAHINDRA | Scorpio Getaway Pik-Up / Wagon | 2002 - 2012 | 12087GR | 12749GR | | | | |
| | Scorpio Getaway Pik-Up | 2012 + | 12087GR | 12731GR | | | | |
| TO SUIT MAZDA | B Series Bravo / BT50 | 1987 - 2011 | 12667GR | 12095GR /C | 24667FE | 24095FE /C /P | 45667FE | 45095FE /C /P |
| | BT50 | 2011 - 5/2020 | 12727GR | 12095GR /C | 24727FE | 24095FE /C /P | 45727FE | 45095FE /C /P |
| | BT50 | 6/2020+ | 12845GR | 12698GR /C /P | 24845FE | 24698FE /C /P | 45845FE | 45698FE /C /P |
| TO SUIT MERCEDES-BENZ | G-Wagen W460, W461, W463 | 1979+ | 12811GR | 12812GR | 24811FE | 24812FE | | |
| | G-Wagen G55 AMG | | | | 24788FE | 24789FE | | |
| | Unimog (6 Bolt Axle) | | | | | | 45803FE | 45803FE |
| | Unimog (10 Bolt Axle) | | | | | | 45802FE | 45802FE |
| | X-Class | 2017 - 5/2020 | 12716GR | 12728GR | 24716FE | 24728FE /P | 45716FE | 45728FE /C /P |
| TO SUIT MITSUBISHI | Triton / L200 | Pre 1993 | 12082GR | 12636GR /C /P | 24082FE | 24636FE /C /P | | |
| | Triton ME-MJ / L200 | 1993 - 1996 | 12082GR | 12636GR /C /P | 24082FE | 24636FE /C /P | | |
| | Triton MK / L200 | 1996 - 2006 | 12087GR | 12698GR /C /P | 24087FE | 24698FE /C /P | | |
| | Triton ML-MN / L200 | 2006 - 2015 | 12715GR | 12636GR /C /P | 24715FE | 24636FE /C /P | | |
| | Triton MQ-MR / L200 | 2015 - 10/2018 | 12715GR | 12729GR /C /P | 24715FE | 24729FE /C /P | | |
| | Pajero / Montero NA-NG (Leaf) | Pre 1991 | 12082GR | 12636GR /C /P | 24082FE | 24636FE /C /P | | |
| | Pajero / Montero NA-NG (Coil) | 1988 - 1991 | 12082GR | 12645GR /C | 24082FE | 24645FE /C | | |
| | Pajero / Montero NH-NL (Leaf) | 1991 - 1999 | 12087GR | 12636GR /C /P | 24087FE | 24636FE /C /P | | |
| | Pajero / Montero NH-NL (Coil) | 6/1991 - 2000 | 12087GR | 12646GR | 24087FE | 24646FE | | |
| | Pajero / Montero NM-NX | 2000+ | 12713GR | 12714GR | 24713FE | | | |
| | Challenger / Montero Sport PA (Leaf) | 1998 - 2006 | 12087GR | 12636GR /C /P | 24087FE | 24636FE /C /P | | |
| | Challenger / Montero Sport PA (Coil) | 1998 - 2008 | 12087GR | 12645GR /C | 24087FE | 24645FE /C | | |
| | Challenger / Pajero Sport / Montero Sport / Dakar PB | 2009 - 2015 | 12715GR | 12645GRS | 24715FE | 24645FES | | |
| | Pajero Sport | 2015+ | 12715GR | 12645GRS | 24715FE | 24645FES | 45715FE | |
| | Delica L400 Without ECS | 1994+ | 12667GR | 12698GR | 24667FE | | | |
| | Delica L400 With ECS | 1994+ | 12667GR | 12671GR | 24667FE | | | |
| TO SUIT NISSAN | Patrol MQ / MK G160 | Pre 1988 | 12075GR | 12076GR | | | | |
| | Patrol GQ / GU SWB & LWB Wagon | 1988 - 1998 | 12091GR | 12094GR | 24091FE | 24094FE /P | 45091FE /P | 45094FE /P |
| | Patrol GQ / GU SWB & LWB Wagon 4" Lift | | | | 24091LFE | 24094LFE /P | 45091LFE /P | 45094LFE /P |
| | Patrol GQ / GU SWB & LWB Wagon 6" Lift | | | | 24091LFE1 | 24094LFE1 | 45091LFE1 | 45094LFE1 |
| | Patrol GQ Y60 Cab Chassis (Leaf) | | 12661GR | 12648GR | 24661FE | 24648FE | 45661FE | 45648FE |
| | Patrol GU Y61 Cab Chassis (Leaf) | | 12091GR | 12648GR | 24091FE | 24648FE | 45091FE /P | 45648FE |
| | Patrol GU Y61 Cab Chassis (Coil) | | 12091GR | 12094GR | 24091FE | 24094FE /P | 45091FE /P | 45094FE /P |
| | Patrol GU Y61 Cab Chassis (Coil) 4" Lift | | | | 24091LFE | 24094LFE /P | 45091LFE /P | 45094LFE /P |

/C = Comfort option available. /P = Professional option available. ¹ Bundera / Wrangler LHS ² Bundera / Wrangler RHS ³ 45780FE, Must use Ironman coil springs TOY063



Application Guide - Shock Absorbers To Suit

| To Suit Make | To Suit Model | Year | Nitro Gas | | Foam Cell | | Foam Cell Pro | |
|--------------------------------|--|----------------|------------|---------------|---------------|---------------|---------------|---------------|
| | | | Front | Rear | Front | Rear | Front | Rear |
| TO SUIT NISSAN | Patrol GU Y61 Cab Chassis (Coil) 6" Lift | | | | 24091LFE1 | 24094LFE1 | 45091LFE1 | 45094LFE1 |
| | Patrol Y62 | 2009+ | 12740GR | 12742GR | 24740FE | 24742FE | 45740FE | 45742FE |
| | Pathfinder / Terrano / II / R20 / WD21 | Pre 1995 | 12667GR | 12636GR /C /P | 24667FE | 24636FE /C /P | | |
| | Pathfinder R51 | 7/2005+ | 12716GR | 12718GR | 24716FE | 24718FE | | |
| | Navara D21 | 1985 - 1996 | 12087GR | 12636GR /C /P | 24087FE | 24636FE /C /P | | |
| | Navara D22 / NP300 (Torsion Bar) | 1997+ | 12791GR | 12636GR /C /P | | | | |
| | Navara D40 / Xterra | 2005+ | 12716GR | 12717GR | 24716FE | 24717FE /P | 45716FE | 45717FE /P |
| | Navara NP300 (Leaf) | 2014+ | 12716GR | 12698GR /C | 24716FE | 24698FE /C /P | 45716FE | 45698FE /C /P |
| | Navara NP300 (Coil) | 2015+ | 12716GR | 12728GR | 24716FE | 24728FE /P | 45716FE | 45728FE /C /P |
| | Paladin | Pre 2005 | 12791GR | 12698GR /C | | 24698FE /C /P | | |
| TO SUIT RAM | 1500 DS | 2014 - 2019 | | | | | 45855FE | 45856FE /C |
| | 1500 DT | 6/2018+ | | | | | 45860FE | 45862FE /C |
| TO SUIT RENAULT / DACIA | Duster | 2010+ | 12747GR | 12748GR | | | | |
| | Alaskan | 2017+ | 12716GR | 12728GR | 24716FE | 24728FE /P | 45716FE | 45728FE /C /P |
| TO SUIT SSANGYONG | Musso Q200 SWB | 10/2018+ | 12823GR | 12824GR | | | | |
| | Musso Q201 / Q215 LWB (Coil) | 10/2018+ | 12823GR | 12825GR | | | | |
| | Musso Q201 / Q205 / Q215 LWB (Leaf) | 10/2018+ | 12823GR | 12826GR | | | | |
| | Musso / Korando | 1996 - 2006 | 12667GR | 12661GRS | 24667FE | 24661FES | | |
| | Rexton Y400 / Y450 | 2018+ | 12823GR | 12828GR | | | | |
| TO SUIT SUBARU | Forester - See pages 250 / 251 for listing | | | | | | | |
| | Outback - See page 252 for listing | | | | | | | |
| | XV Crosstrek - See page 253 for listing | | | | | | | |
| TO SUIT SUZUKI | Jimmy SN413 / GJ | 1998+ | 12759GR | 12760GR | | | | |
| | Sierra / Samurai LJ / SJ (Leaf) | 1981+ | 12085GR | 12086GR | | | | |
| | Vitara SWB | 1988+ | 12083GR | 12089GR | | | | |
| | Vitara LWB | 1988+ | 12083GR | 12658GR | | | | |
| | Grand Vitara SWB | 1988 - 7/2005 | 12083GR | 12089GR | | | | |
| | Grand Vitara LWB | 1988 - 7/2005 | 12083GR | 12658GR | | | | |
| | Grand Vitara | 8/2005 - 2015 | 12721GR | 12722GR | | | | |
| TO SUIT TOYOTA | 4Runner Gen 1, N60 (Leaf) | 1988 - 1997 | 12088GR | 12650GR /C | 24088FE | 24650FE /C /P | | |
| | 4Runner / Surf Gen 2, N130 V6 (Coil) | 1990 - 1997 | 12088GR | 12637GR /C | 24088FE | 24637FE /C | | |
| | 4Runner Gen 3, N180-N185 | 1996 - 2002 | 12691GR | 12661GR | 24691FE | 24661FE | 45691FE | 45661FE |
| | 4Runner Gen 4 & 5, N210-N280 | 2003+ | 12710GR | 12682GR /C /P | 24710FE | 24682FEC /P | 45710FE | 45682FEC /P |
| | FJ Cruiser | 2006+ | 12710GR | 12682GR /C /P | 24710FE | 24682FE /C /P | 45710FE | 45682FE /C /P |
| | Fortuner | 2004 - 2015 | 12710GR | 12743GR /C | 24710FE | 24743FE /C | 45710FE | 45743FE /C |
| | Fortuner | 2015+ | 12730GR | 12743GR /C | 24730FE | 24743FE /C | 45730FE | 45743FE /C |
| | Hiace Series 200 | 2005 - 2019 | 12667GR | 12805GR | 24667FE | 24805FE | | |
| | Hiace Series 300 | 2019+ | | | 24840FE | 24842FE /C | | |
| | Hilux Solid Front Axle | 1979 - 10/1983 | 12639GR /C | 12636GR /C /P | 24639FE | 24636FE /C /P | | |
| Hilux Solid Front Axle | 11/1983 - 11/1997 | 12639GR /C | 12650GR /C | 24639FE | 24650FE /C /P | | | |

/C = Comfort option available. /P = Professional option available. ¹ Bundera / Wrangler LHS ² Bundera / Wrangler RHS ³ 45780FE, Must use Ironman coil springs TOY063



Application Guide - Shock Absorbers To Suit

| To Suit Make | To Suit Model | Year | Nitro Gas | | Foam Cell | | Foam Cell Pro | |
|----------------------------------|---|------------------|---------------|---|-------------|---|---------------|---------------|
| | | | Front | Rear | Front | Rear | Front | Rear |
| TO SUIT TOYOTA | Hilux / Tiger / 107 / 108 / 110 / 111 / 167 | 1997 - 2005 | 12088GR | 12081GR /C | 24088FE | 24081FE /C /P | | |
| | Hilux Low Ride 2WD | 2005+ | 12764GR | 12650GR /C | | 24650FE /C /P | | |
| | Hilux / Vigo | 2005 - 2015 | 12710GR | 12650GR /C | 24710FE | 24650FE /C | 45710FE | 45650FE /C |
| | Hilux / Vigo Long Travel | 2005 - 2015 | 12710GR | 12081GR /C | 24710FE | 24081FE /C /P | 45710FE | 45081FE /C /P |
| | Hilux / Revo | 2015+ | 12730GR | 12081GR /C | 24730FE | 24081FE /C /P | 45730FE | 45081FE /C /P |
| | Landcruiser 40 / 42 / 45 / 46 / 47 Series | 1960 - 1980 | 12635GR /C | 12636GR /C /P | 24635FE /C | 24636FE /C /P | 45635FE | 45636FE /C /P |
| | Landcruiser 60 Series | Pre 1986 | 12637GR /C | 12636GR /C /P | 24637FE /C | 24636FE /C /P | 45637FE /C | 45636FE /C /P |
| | Landcruiser 60 Series | 1986+ | 12637GR /C | 12650GR /C | 24637FE /C | 24650FE /C /P | 45637FE /C | 45650FE /C /P |
| | Landcruiser 70 / 73 / 74 Series (Leaf/Leaf) | 1984 - 1988 | 12637GR /C | 12650GR /C | 24637FE /C | 24650FE /C /P | 45637FE /C | 45650FE /C /P |
| | Bundera | 1984 - 1989 | 12091GR | 12639GRS ¹ 12650GR ² | 24091FE | 24639FES ¹ 24650FE ² | | |
| | Landcruiser II / Prado 70 / 73 / 78 Series | 1990 - 1996 | 12696GR | 12697GR | 24696FE | 24697FE | | |
| | Landcruiser 71 Series (Coil/Leaf) | 1991+ | 12091GR | 12081GR /C | 24091FE | 24081FE /C /P | 45091FE /P | 45081FE /C /P |
| | Landcruiser 75 Series | 1984 - 1999 | 12637GR /C | 12081GR /C | 24637FE /C | 24081FE /C /P | 45637FE /C | 45081FE /C /P |
| | Landcruiser 76 / 78 / 79 / 70 & D/Cab | 2007+ | 12091GR | 12094GR /C | 24091FE | 24094FE /C /P | 45091FE /P | 45094FE /C /P |
| | Landcruiser 76 / 78 / 79 / 70 & D/Cab Long Travel | 2007+ | | | 24091FE | 24094LFE /P | 45091FE /P | 45094LFE /P |
| | Landcruiser 80 / 105 Series | 1990+ | 12683GR | 12682GR | 24683FE | 24682FE | 45683FE | 45682FE |
| | Landcruiser 80 / 105 Series 4" Lift | 1990+ | | | 24683LFE | 24682LFE | 45683LFE | 45682LFE |
| | Landcruiser 80 / 105 Series 6" Lift | 1990+ | | | 24683LFE1 | 24682LFE1 | 45683LFE1 | 45682LFE1 |
| | Landcruiser 100 Series IFS | 1998+ | 12795GR | 12796GR | 24795FE | 24796FE | 45795FE | 45796FE /P |
| | Landcruiser 200 Series | 2007+ | 12720GR | 12796GR | 24720FE | 24796FE | 45720FE | 45796FE /P |
| | Landcruiser 300 Series | 2020+ | | | 24883FE | 24884FE | 45883FE | 45884FE /P |
| | Prado 90 / 95 Series | 1996 - 10/2002 | 12691GR | 12661GR | 24691FE | 24661FE | 45691FE | 45661FE |
| | Prado 120 Series (except Grande) | 4/2003 - 10/2009 | 12710GR | 12682GR /C /P | 24710FE | 24682FEC /P | 45710FE | 45682FEC /P |
| | Prado 150 Series (except Kakadu) | 2009-11/2017 | 12750GR | 12682GR /C /P | 24750FE | 24682FEC /P | 45750FE | 45682FEC /P |
| Prado 150 Series (except Kakadu) | 12/2017+ | 12710GR | 12682GR /C /P | 24710FE | 24682FEC /P | 45710FE | 45682FEC /P | |
| Tacoma | 2005+ | 12710GR | 12744GR | 24710FE | 24744FE | 45710FE | 45744FE | |
| Tundra | 2006 - 2021 | | | 24780FE | 24781FE | 45780FE ³ | 45781FE | |
| TO SUIT TROLLER | T4 | 1997 - 6/2014 | 12765GR | 12765GR | | | | |
| | T4 | 7/2014+ | 12755GR | 12755GR | | | | |
| TO SUIT UAZ | Hunter | | 12652GR | 12698GR | 24652FE | 24698FE | | |
| | Patriot | | 12637GRS | 12698GR | 24637FES | 24698FE | | |
| TO SUIT VOLKSWAGEN | Amarok | 2010+ | 12725GR | 12726GR | | | | |

/C = Comfort option available. /P = Professional option available. ¹ Bundera / Wrangler LHS ² Bundera / Wrangler RHS ³ 45780FE, Must use Ironman coil springs TOY063



Features and Benefits

NITRO GAS SHOCK ABSORBERS

Gas Pressurised shock absorber boosts performance and adapts to a wide range of driving styles

NITROGEN GAS PRESSURISED - Low pressure nitrogen gas dramatically reduces the likelihood of oil aeration and shock fade.

35mm TEFLON BANDED PISTON - Precision shim-stack piston specifically valved by Ironman suspension engineers, banded with teflon for smooth long life operation.

54mm TWIN TUBE BODY - Increased oil volume for improved cooling and endurance, Twin tube construction protects internal components from rock damage.

16mm – 18mm HARD CHROME PISTON ROD - Hardened and polished, volumetrically balanced to piston size.

FLEXIBLE RUBBER BUSHES - Offers quieter operation and reduces damaging side loads from shock absorber.

TRIPLE-LIP HIGH PRESSURE NOK SEAL - Maximum gas and oil retention ability to withstand high displacement offroad use.

SUPPLEMENTARY WELDED MOUNTS - Fusion welded and supplementary welded for maximum strength and reliability.

SINGLE PIECE BILLET EYE RINGS AND STEMS - Ultra robust design prevents breakage or bending of mounts.

VEHICLE SPECIFIC VALVING - Every part number is specially valved for each vehicle application, this ensures the best possible ride and handling as intended by Ironman suspension engineers.

LONG TRAVEL - Suitable for standard and raised height vehicles, additional length increases wheel articulation.

IMPACT RESISTANT STONE SHIELD - Steel or Polyethylene dust shield protects piston rod from impacts and road debris.



SUPPLEMENTARY WELDED MOUNTS - Fusion welded then supplementary welded for higher strength and reliability.

360° WELDED MOUNTS - Fusion welded then fully welded around mounting for maximum strength and reliability.

SINGLE PIECE BILLET EYE RINGS AND STEMS - Ultra robust design prevents breakage or bending of mounts.

VEHICLE SPECIFIC VALVING - Every part number is specially valved for each vehicle application, this ensures the best possible ride and handling as intended by Ironman suspension engineers.

LONG TRAVEL - Suitable for standard and raised height vehicles, additional length increases wheel articulation.

IMPACT RESISTANT STONE SHIELD - Steel or Polyethylene dust shield protects piston rod from impacts and road debris.

COIL SPRINGS

Available in a wide range of load ratings to maintain optimum ride height

COLD COILED - CNC cold coiling ensures perfect consistency and accuracy, less heat during manufacture maintains material properties resulting in longer life.

BAR PEELED - Bar peeling is the process of forming the material to an exact size before coiling, this ensures the diameter remains constant and free of flaws along its entire length.

SHOT PEENED - Manipulates material surface tension to reduce stress, greatly enhances spring life.

TRIPLE SCRAGGED - Each coil is fully compressed to a solid state 3 times to minimise coil settling.

PROGRESSIVE AND LINEAR RATE - Used in accordance to original vehicle manufacturers preference, progressive springs increase rate as the spring compresses, linear springs maintain a consistent rate throughout its range.

POWDERCOATED - All springs are electro-static powdercoated for a durable finish.



FOAM CELL SHOCK ABSORBERS

Premium shock absorber for superior endurance in all conditions

FOAM CELL TECHNOLOGY - Micro-Cellular closed cell foam insert maximises cooling efficiency by occupying less internal space than gas within a pressurised shock absorber. Greater oil capacity and more surface area maintains lower operating temperatures.

40-45mm TEFLON BANDED PISTON - Precision shim-stack piston specifically valved by Ironman suspension engineers, banded with teflon for smooth long life operation.

60-72mm TWIN TUBE BODY - 50%-100% more oil volume than a gas shock absorber for superior cooling and endurance. Twin tube construction protects internal components from rock damage.

18-20mm HARD CHROME PISTON ROD - Hardened and polished, volumetrically balanced to piston size.

FLEXIBLE RUBBER BUSHES - Offers quieter operation and reduces damaging side loads from shock absorber.

TRIPLE-LIP HIGH PRESSURE NOK SEAL - Maximum oil retention ability to withstand high displacement offroad use.



LEAF SPRINGS

Available in a wide range of load ratings to maintain optimum ride height

INTER LEAF LINERS - Used in some applications to lower friction between leaves reducing noise and improving - Comfort.

LINED BOLT CLAMPS - All Ironman springs feature bolted guide clamps for greater flex, the addition of anti-friction liners ensures noise free smooth operation.

SHOT PEENED - Manipulates tension side of material to reduce stress, greatly enhances spring life.

DIAMOND CUT LEAVES - Distributes load at the leaf tip and reduces interleaf friction.

MILITARY WRAP - Where applicable, an additional wrap around the leaf eye protects from failure in case of damage.



Features and Benefits

TORSION BARS

Higher spring rate to support extra weight from additional vehicle accessories

UP-SET FORGED ENDS - Stronger than machining alone, forging manipulates steel grain for superior strength and durability.

PREMIUM MICRO-ALLOY STEEL - Exceeds OEM steel grade for ultra long life and less sag.

INCREASED BAR DIAMETER - Higher spring rate better supports added accessories and balances front and rear suspension performance.

X-RAY EXAMINED - Each and every Ironman Torsion Bar is X-Ray tested to eliminate risk of breakage due to material flaw.

DIRECTIONAL PRE-SETTING - Torsion Bars are rotationally pre-set in their direction of installation to reduce spring settling. Each bar is marked for left or right fitment.

POLYURETHANE BUSHES

Provide precise spring location and enables lubrication to increase suspension flex and - Comfort

INJECTION MOULDED POLYURETHANE - High density injection moulded polyurethane material ensures precise location and a durable bearing surface for your leaf springs, making them very durable in hot temperatures whilst providing a soft - Comfortable vehicle ride.

GREASABLE - Polyurethane bushes are greasable to aid in longer life and ensure smooth ride and quiet operation.

SPIRAL BORE AND FLANGES - To distribute lubricating grease evenly throughout the bushing surface when combined with greasable shackles and pins.

SPLINES - Allows the bush to conform to irregularities and grip to the eye surface.

GREASABLE SHACKLES AND PINS

Enables easy re-greasing of polyurethane spring bushes

QUAD-OUTLET GREASABLE - Greasable shackles provide an easy method of re-lubricating polyurethane bushes. Chamfered Quad-Outlet ports distribute grease liberally along the bush surface.

SERVICEABLE - All Ironman shackles and pins feature a serviceable bolt together construction.

ANTI-INVERSION SHACKLE - On selected models, a third pin is positioned on the shackle to protect the spring in the case of inversion.

CASTER CORRECTION PLATES

Used to correct caster angle after raising suspension beyond 100mm (4")

PRE-CONFIGURED CASTER CORRECTION - Fixed 5 degree offset models suit 100mm (4") to 150mm (6") lifted suspension.

STEERING DAMPER

Reduce unwanted vibration and feedback through steering system in rough conditions

FOAM CELL TECHNOLOGY - Micro-Cellular closed cell foam insert allows for the horizontal mounting orientation required by a steering damper.

35mm TEFLON BANDED PISTON - Precision shim-stack piston specifically valved by Ironman suspension engineers, banded with Teflon for smooth long life operation.

54mm TWIN TUBE BODY - Increased oil volume improves cooling and endurance, twin tube construction protects internal components from impact damage.

SUPPLEMENTARY WELDED MOUNTS - Fusion welded and supplementary welded for maximum strength and reliability.

SINGLE PIECE BILLET EYE RINGS AND STEMS - Ultra robust design prevents breakage or bending of mounts.

VEHICLE SPECIFIC VALVING - Every part number is specially valved for each vehicle application, this ensures the steering operation is smooth and unhindered by the effects of rough road driving.

CASTER CORRECTION BUSHES

Available in adjustable or fixed offset designs, used to correct caster angle after raising suspension under 100mm (4")

PRE-CONFIGURED CASTER CORRECTION - Fixed 2 degree offset models suit 50mm (2") lifted suspension.

ADJUSTABLE CASTER CORRECTION - Adjustable offset suit a wide range of lift heights up to 100mm (4")

HIGH DENSITY MATERIALS - Vehicle specific rubber or polyurethane material.

ADJUSTABLE PANHARD RODS

Used to correct axle shift after raising suspension. Adjustable as required to re-centralise axle to vehicle

COMPETITION SPEC - 32mm solid rod used throughout.

FINE THREAD ADJUSTMENT - M32 x 2mm thread ensures precision adjustment for greater accuracy.

OEM STYLE RUBBER BUSHES - Maximum flex and durability. Replaceable OEM style bushes.

EXTENDED SWAY BAR LINKS

Recalibrates sway bar index after raising suspension.

VEHICLE SPECIFIC BOLT ON DESIGN - Easy fitment, utilises OEM mounting locations.

ADJUSTABLE LENGTH - Adjustable extension where possible depending on vehicle model.

PRACTICAL DESIGN - Strongest construction up-spec materials to avoid bending and breaking. Rubber bushes and aircraft grade spherical bearings used where possible depending on vehicle model.

Features and Benefits

POLYURETHANE COIL SPRINGS SPACERS / TRIM PACKERS



Available individually to adjust "side to side" or "front to back" vehicle lean due to uneven load placement

INJECTION MOULDED POLYURETHANE - High density injection moulded polyurethane material ensures precise location and a durable seat with the spring.

PRE-CONFIGURED THICKNESSES - Varied thicknesses allow correct selection according to the amount of lean. Provides 1:1 ratio suspension lift on solid axle vehicles.

SELF LOCATING DESIGN - Raised profile locating flanges prevent packer from becoming dislodged or falling out.

STRUT TRIM PACKERS



For use only with Ironman 4x4 struts, available individually to adjust "side to side" or "front to back" vehicle lean due to uneven load placement.

PRECISE RIDE HEIGHT TUNING - Basic steel collar design fits over Ironman 4x4 struts to adjust spring seat height.

PRE-CONFIGURED THICKNESSES - Varied thicknesses allow correct selection according to the amount of adjustment required. Usually provides 1:2 ratio suspension lift on independent suspension vehicles.

EXTENDED BRAKE HOSES



Longer brake hose used with suspension lifts over 100mm (4").

DOT SAE J1401 STANDARDS APPROVED CONSTRUCTION - OEM style reinforced rubber hose for safety.

EXTENDED LENGTH - Extended length allows for greater suspension travel.

ADJUSTABLE TRAILING ARMS



Used to correct rear axle tilt and location after raising suspension.

COMPETITION SPEC - 32mm solid rod used throughout.

FINE THREAD ON-VEHICLE ADJUSTMENT - M32 x 2mm thread ensures precision adjustment for greater accuracy.

OEM STYLE RUBBER BUSHES - Maximum flex and durability. Replaceable OEM compatible bushes.

CASTER WEDGES



Adjusts the caster angle within solid axle vehicles, or changes pinion angle to remove unwanted driveline vibration.

SUITS - 60-70mm wide leaf springs. Breakaway side section can be removed for narrower springs.

AVAILABLE IN - 1, 2, 3 and 4 degree increments.

SWAY BARS



Enhanced performance direct replacement sway bars featuring maximum bar diameter with factory compatible fitment.

SHORE A 70 DURO NR - Bushes maximum flex and durability.

ADJUSTABLE STEERING RODS



Adjustable length rod to centralise steering wheel after suspension lift.

ADJUSTABLE LENGTH - Compatible with all suspension ride heights.

STRONGER CONSTRUCTION - Reduces likelihood of failure due to impact.

BOLT ON STEERING DAMPER MOUNTS - Steering damper mounts can be positioned freely as required to suit suspension lift.

STRUT MOUNTS



Direct replacement for the OEM mounts. Facilitates the pre-assembly of complete new struts without disassembly of old unit.

FULLY OEM COMPATIBLE - Easy Installation.

SHORE A 80 DURO NR BUSHES & INSULATORS - Extended durability and precise location accuracy.

HEAVY DUTY WASHERS - Resists deformation in extreme use.

ADD-A-LEAF



Additional universal tapered leaf to upgrade existing leaf springs.

Eliminates suspension sag and supports additional load.

Improves - Comfort and handling.

Increases load carrying capability and ride height.

RUBBER BUSHES



Direct replacement for the OEM bushes, compatible with OEM and Ironman 4x4 suspension arms.

OEM STYLE RUBBER BUSHES - Easy press in replacement bushes, retains factory ride quality.

SHORE A 70 DURO NR - Maximum flex and durability.

PRO-FORGE CONTROL ARMS



Provides corrected wheel alignment and greater operating clearance, allows for the installation of larger tyres and further increases ride height.

HIGH STRENGTH FORGED ALLOY - Stronger and more durable than a cast, machined or fabricated arm.

BUSHES AND BALL JOINT - Replaceable with OEM compatible or genuine components.

Features and Benefits



SUSPENSION KITS

Fully integrated suspension kits containing all required components to achieve a safe and balanced suspension performance.

ALL LEAF SPRINGS KITS CONTAIN: Springs, Shock Absorbers, U-bolts and Bushes.

ALL COIL SPRINGS KITS CONTAIN: Springs and Shock Absorbers.

Ironman 4x4 also offer various optional components further enhancing suspension performance or geometry correction purposes, see vehicle listings for model specific details.

Such components include Greasable Shackles & Pins, Steering Damper, Caster Correction, Trim Packers, Suspension Arms.



LEAF / LEAF (LL) SUSPENSION KIT



STRUT / LEAF (SL) SUSPENSION KIT



COIL / COIL (CC) SUSPENSION KIT



STRUT / COIL (SC) SUSPENSION KIT



TORSION BAR / LEAF (TL) SUSPENSION KIT



TORSION BAR / COIL (TC) SUSPENSION KIT

Please note: Not all coil springs are available in green and some may be supplied in yellow. Please check before ordering.

Load Plus Helper Springs



Load Plus

Helper Spring Kit



**Without
Load Plus**



**With
Load Plus**

- ✓ Maximise vehicle payload
- ✓ Reduce sway by up to 40%
- ✓ Improve safety and stability
- ✓ Reduce brake pitch by up to 20%
- ✓ Reduce tyre, brake and suspension wear
- ✓ Improve ride by up to 35%
- ✓ Reduce rear end sag by up to 20%



Load Plus Helper Springs - Application Guide

| TO SUIT CHRYSLER / DODGE / PLYMOUTH | | Part No |
|---|--------------|---------|
| B1500, B2500, B3500 - Vans | All | LP7 |
| Caravan, T & C Van & Voyager | All | LP7 |
| | All | LP4 |
| D50 & Ram 50 | All | LP4 |
| D100, D150, D200 & D250 | All | LP4 |
| Dakota | All | LP4 |
| Durango | All | LP4 |
| R1500 & R2500 | w/ 2.5" Leaf | LP4 |
| R1500 & R2500 | w/ 3.0" Leaf | LP7 |
| Raider | All | LP4 |
| Ramcharger & Trailduster | All | LP4 |
| W100, W150, W200 & W250 | All | LP4 |
| TO SUIT DAIHATSU | | |
| Feroza F300, F310 | 88-99 | LP1 |
| Feroza II | All | LP4 |
| Rocky | All | LP1 |
| TO SUIT FIAT | | |
| Fullback | All | LP3 |
| TO SUIT FORD / LINCOLN / MERCURY | | |
| Bronco | w/ 2.5" Leaf | LP4 |
| | w/ 3.0" Leaf | LP7 |
| Bronco II | w/ 2.5" Leaf | LP4 |
| | w/ 3.0" Leaf | LP7 |
| Courier / Ranger (Not USA model) | All | LP3 |
| Econovan & Spectron | All | LP1 |
| E Series Vans | w/ 2.5" Leaf | LP4 |
| | w/ 3.0" Leaf | LP7 |
| Excursion | All | LP7 |
| Explorer | w/ Leaf | LP4 |
| Falcon Sedan XR-XD | All | LP4 |
| Falcon Panel Van XR-XH | All | LP4 |
| Falcon Utility 1 Tonne XR - On | All | LP4 |
| F Series | w/ 2.5" Leaf | LP4 |
| | w/ 3.0" Leaf | LP7 |
| Mountainer & Aviator | All | LP4 |
| Ranger (USA model only) | All | LP4 |
| * Not suitable for Falcon wagon, except dedicated LPG | | |
| TO SUIT GENERAL MOTORS / CHEVROLET / HOLDEN | | |
| Commodore 1 Tonne | All | LP1 |
| Jackaroo | All | LP3 |
| Rodeo / Colorado / D-Max* | 81-03 | LP3 |
| Shuttle | All | LP3 |
| Utility and Van HQ-WB | All | LP4 |
| Astro & Safari Van | w/ Leaf | LP4 |
| C, K, R & V Series 1/2 & 3/4 Ton | w/ 2.5" Leaf | LP4 |
| | w/ 3.0" Leaf | LP7 |
| Denali & Escalade | All | LP7 |
| G Series, Express 1/2 3/4 & 1 Ton | w/ 2.5" Leaf | LP4 |
| | w/ 3.0" Leaf | LP7 |
| Savannah Vans 1/2 3/4 & 1 Ton | w/ 2.5" Leaf | LP4 |
| | w/ 3.0" Leaf | LP7 |
| LUV | All | LP3 |
| S10 Blazer & T10 | All | LP4 |
| S15 Jimmy, T15 & Sonoma | All | LP4 |
| Suburban 1/2 3/4 Ton | w/ 2.5" Leaf | LP4 |
| | w/ 3.0" Leaf | LP7 |
| Tahoe & Yukon | w/ 2.5" Leaf | LP4 |
| | w/ 3.0" Leaf | LP7 |
| Silverado | All | LP7 |
| *Not suitable for Rodeo / Colorado / D-Max 2003+ Models with interleaf liners | | |
| TO SUIT HONDA | | |
| Passport | w/ Leaf | LP3 |
| TO SUIT INTERNATIONAL | | |
| Scout | All | LP3 |

| TO SUIT ISUZU | | |
|---|---------|-----|
| Amigo | All | LP3 |
| Hombre | All | LP3 |
| Pickup, P'up | All | LP3 |
| Rodeo | w/ Leaf | LP3 |
| Trooper II | w/ Leaf | LP3 |
| TO SUIT JEEP | | |
| Cherokee & Wagoneer | All | LP4 |
| CJ5, CJ6 & CJ7 | All | LP4 |
| Comanche Pickup | All | LP4 |
| Gladiator Pickup | All | LP4 |
| J10 & J20 Series | All | LP4 |
| Wrangler YJ | All | LP4 |
| TO SUIT KIA | | |
| Pregio | All | LP4 |
| TO SUIT LDV | | |
| T60 | All | LP2 |
| TO SUIT MAZDA | | |
| Navaho | All | LP4 |
| Pickups | All | LP3 |
| Bravo / BT50 | All | LP3 |
| B1800 / B2000 4x2 | All | LP3 |
| B2200 / B2600 4x2 4x4 | All | LP1 |
| E1400 | All | LP1 |
| E1800 | All | LP1 |
| E2000 | All | LP1 |
| E2200 | All | LP1 |
| TO SUIT MERCEDES BENZ | | |
| MB100 | 99-02 | LP4 |
| MB140 | 99-02 | LP4 |
| Sprinter | 98 On | LP4 |
| TO SUIT MITSUBISHI | | |
| Pickup | All | LP4 |
| Pajero / Montero | w/ Leaf | LP4 |
| Triton ME-MN L200 | All | LP4 |
| Triton MQ L200 | All | LP3 |
| L200 / L300 Van | All | LP4 |
| Starwagon / Express Van | All | LP4 |
| TO SUIT NISSAN | | |
| Frontier | All | LP2 |
| X-Terra | All | LP2 |
| Titan | All | LP2 |
| Navara D21 D22 | All | LP3 |
| Navara D40 | All | LP2 |
| Navara NP300 (leaf) | All | LP2 |
| Urvan | All | LP3 |
| Patrol GQ / GU Cab / Chassis | All | LP4 |
| Patrol MQ / MK, G160, Y260 | All | LP3 |
| TO SUIT SUZUKI | | |
| Sierra / Samurai | All | LP5 |
| TO SUIT TOYOTA | | |
| To Suit Pickups | All | LP2 |
| To Suit T100 | All | LP4 |
| To Suit Tundra | All | LP3 |
| To Suit Hiace | All | LP3 |
| To Suit Hilux / 4Runner | All | LP2 |
| To Suit Landcruiser FJ40 / BJ40-42 | 60-84 | LP4 |
| To Suit Landcruiser FJ / HJ60 / 61 / 62 | 80-90 | LP4 |
| To Suit Landcruiser HJ / HZJ 75* | 84-99 | LP4 |
| To Suit Landcruiser HZJ 78 / 79* | All | LP9 |
| To Suit Landcruiser 76* | All | LP4 |
| To Suit Tacoma | All | LP2 |
| To Suit Townace | All | LP1 |
| * Suits Landcruiser drum brake rear models only | | |
| TO SUIT VOLKSWAGEN | | |
| Amarok | All | LP4 |



DRIVE LIKE A PRO

Suspension kits built for
Comfort - Performance - Constant Load



FOAMCELL^{PRO}
Suspension Kit

The ultimate upgrade with the most
robust design suitable for all conditions

Colours and styles may vary between models. Prices do not include freight or fitting and are subject to change without notice.

www.ironman4x4.com



Suspension Specifications

Effective 1 December 2022

Recommended Installation Times

Average installation times are based on one experienced fitter with all the necessary tools and equipment

SUSPENSION KITS

| | | |
|---------------------------------------|-----------------------------|----------------|
| COIL SPRINGS Front | LEAF SPRINGS Rear | 3 Hours |
| STRUT Front | COIL SPRINGS Rear | 3 Hours |
| STRUT Front | LEAF SPRINGS Rear | 4 Hours |
| TORSION BAR Front | COIL SPRINGS Rear | 3 Hours |
| TORSION BAR Front | LEAF SPRINGS Rear | 4 Hours |
| COIL SPRINGS Front and Rear | | 2 Hours |

| | |
|---------------------------------------|----------------|
| LEAF SPRINGS Front and Rear | 5 Hours |
| STRUT Front and Rear | 4 Hours |
| LAND ROVER MODELS | 3 Hours |
| VOLKSWAGEN AMAROK | 5 Hours |
| MITSUBISHI PAJERO 2000 + | 4 Hours |
| MITSUBISHI TRITON 2005 + | 5 Hours |

SUSPENSION COMPONENTS

| | |
|--|------------------|
| COIL SPRINGS Pair | 1 Hour |
| COIL SPRINGS Pair Independent Suspension | 2 Hours |
| COIL SPRINGS Pair with Existing Airbags | 2 Hours |
| LEAF SPRINGS Pair | 2 Hours |
| LEAF SPRINGS Pair with Existing Airbags | 2.5 Hours |

| | |
|--------------------------------------|-----------------|
| TORSION BARS Pair | 2 Hours |
| STRUT SHOCK ABSORBERS Pair | 2 Hours |
| SHOCK ABSORBERS Pair | 1 Hour |
| STEERING DAMPER | 0.5 Hour |
| CASTER CORRECTION BUSHES | 2 Hours |

All times to be used as a guide only, times may vary depending on experience and equipment. Pre existing modifications or accessories may also increase installation times. Always allow extra time for unforeseen issues or rusted components. Always use Ironman 4x4 Suspension Installation Form to record ride height before and after, vehicle and owner details.

WHEEL ALIGNMENT

| | |
|--------------------------------------|-----------------|
| SOLID AXLE Wheel Alignment | 0.5 Hour |
|--------------------------------------|-----------------|

| | |
|--|---------------|
| INDEPENDENT SUSPENSION Wheel Alignment | 1 Hour |
|--|---------------|

Ironman 4x4 recommend a wheel alignment be performed after installation or within 1 week, always ensure suspension is fully settled before wheel alignment.

As a minimum, toe settings will require adjustment after raising suspension. Camber and Caster settings are an important aspect and should be maintained close to manufacturers specifications.

Consideration to road crown should be given.

It is advisable to induce slightly more (positive caster) and (negative camber) on the kerb side wheel to help maintain directional stability.

As a general rule of thumb it is recommended to adjust as follows: (Unless tyre wear dictates otherwise).

Independent Front Suspension vehicles will generally result in increased toe-in when raised.

Total Toe: +1mm to -1mm.

Solid Front Axle vehicles generally only allow toe adjustment.

Total Toe +1mm to -1mm

4 Wheel Independent Suspension vehicles will require a 4 wheel alignment to ensure front and rear wheels are true to the geometric centreline of the vehicle.

Rear Total Toe: +1mm to +3.5mm (Do not set with Toe Out)

Front Total Toe: +1 to -1mm

Optimal wheel alignment settings can vary between vehicles, the above is to be used as a guide only, different ride heights may require different settings. Always monitor tyre wear and pressures and adjust accordingly.

Installation Form



SUSPENSION INSTALLATION FORM IRONMAN 4X4

**Please copy and complete this form at the time of installation.
Keep in a safe place for future reference.**

Always ensure you have all the correct parts before beginning installation.

Installing suspension often requires special tools and expert knowledge. All fitment should be performed by a qualified and experienced fitter.
Always tighten bushed components after the vehicle is let down onto the ground at normal ride height, otherwise damage from torsional stresses can occur.
Ironman 4x4 recommends a wheel alignment after fitment of new suspension, consideration to natural spring settling should be taken into account before alignment is done.
Always adhere to vehicle manufacturers torque specification when tightening fasteners.
Always grease polyurethane bushes prior to fitment, Ironman 4x4 recommends a molybdenum based grease or grease specified for polyurethane.

**If necessary, brake proportioning valve should only be adjusted and tested by a qualified brake specialist.
Further ADAS safety systems may need to be recalibrated by a qualified service technician.**

YOUR DETAILS

Name: _____ Phone: _____
Email: _____ Invoice: _____

VEHICLE DETAILS

Make: _____ Model: _____ VIN / Reg No: _____
Odometer: _____ Engine Type: _____ Body Type: _____

Pre-Existing Modifications (Please Circle Items Fitted)

| | | | | |
|----------------------|-----------------|----------------------------|---------------------|------------------------|
| No Accessories | Recovery Points | Long Range Fuel Tank | Rear Drawers | Canopy |
| Bull Bar | Side Steps | Slide-Away Roll Up Tonneau | Fridge | Service Body |
| Winch | Side Rails | Awning | Dual Battery System | Rear Protection Bumper |
| Underbody Protection | Tow Bar Only | Rooftop Tent | Roof Rack | Water Tank |

SUSPENSION COMPONENT DETAILS

| Item | Part No. | Batch No. | Item | Part No. | Batch No. |
|------|----------|-----------|------|----------|-----------|
| 1 | _____ | _____ | 11 | _____ | _____ |
| 2 | _____ | _____ | 12 | _____ | _____ |
| 3 | _____ | _____ | 13 | _____ | _____ |
| 4 | _____ | _____ | 14 | _____ | _____ |
| 5 | _____ | _____ | 15 | _____ | _____ |
| 6 | _____ | _____ | 16 | _____ | _____ |
| 7 | _____ | _____ | 17 | _____ | _____ |
| 8 | _____ | _____ | 18 | _____ | _____ |
| 9 | _____ | _____ | 19 | _____ | _____ |
| 10 | _____ | _____ | 20 | _____ | _____ |

NOTES AND COMMENTS

SUSPENSION MEASUREMENTS

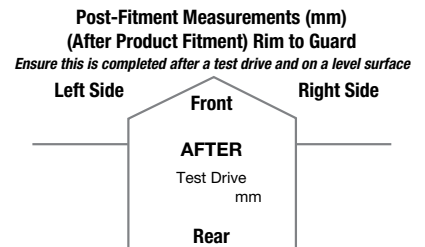
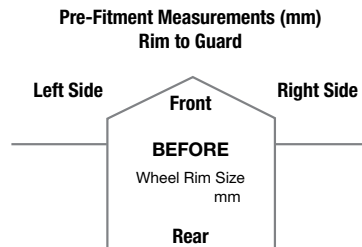
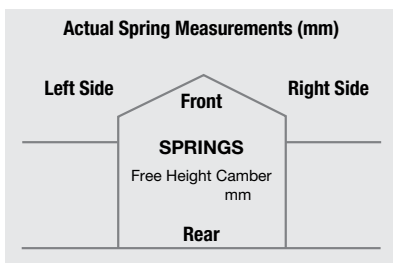

POST INSTALLATION INSPECTION

All fitting, fasteners and wheels have been tensioned to the correct manufacturers specifications and marked with a paint pen where appropriate.
 TICK

INSTALLERS NAME: _____ PRINT NAME

SIGNATURE: _____

DATE OF INSPECTION: _____

COMPLETED: PRINTED FORM COMPLETED AND UPLOADED INTO ONLINE SUSPENSION FORM

All measurements to be taken prior to installation, immediately after initial test drive and again at 500km check.
All vehicle height measurements to be taken from lower of wheel rim to guard unless otherwise stated.
Up to 10mm height reduction in springs can be considered normal settling over time.
Suspension product warranty period is 4 years or unlimited km, GVM warranty period is 2 years or 40,000km unless otherwise stated.

SIF/281122 Rev.5



Coil Springs

COIL SPRING MEASUREMENT REFERENCE

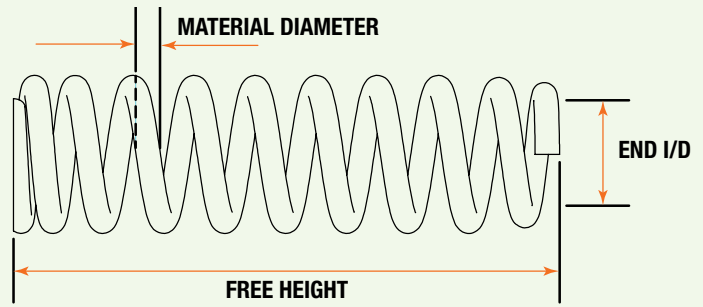

| Part Number | Material | Free Height | End I/D | Spring Rate N/mm | Spring Rate lb/in |
|-------------|----------|-------------|----------|------------------|-------------------|
| FOR001A | 17 | 372 | 81 | 115 | 656 |
| FOR001B | 17.5 | 375 | 81 | 124 | 708 |
| FOR001C | 18 | 373 | 81 | 136 | 776 |
| FOR001S | 17.5 | 355 | 81 | 124 | 708 |
| FOR003B | 18 | 505 | 90/135 | 40-56 | 228-320 |
| FOR003C | 18 | 515/520 | 90/135 | 56 | 320 |
| FOR003S | 18 | 475 | 90/135 | 40-56 | 228-320 |
| FOR005A | 17.5 | 381 | 81 | 118 | 673 |
| FOR005B | 18 | 381 | 81 | 126 | 719 |
| FOR005C | 18 | 387 | 81 | 132 | 753 |
| FOR005S | 18 | 365 | 81 | 126 | 719 |
| HOLD008B | 16.4 | 425 | 104 | 43 | 246 |
| HOLD008C | 17 | 420 | 106 | 48 | 274 |
| HOLD020A | 16.5 | 382 | 66/76 | 100 | 571 |
| HOLD020B | 17 | 375 | 66/76 | 110 | 628 |
| HOLD020C | 18 | 370 | 66/76 | 127 | 725 |
| HOLD020S | 17 | 362 | 66/76 | 100 | 571 |
| HOLD022A | 15 | 400 | 66 | 40 | 228 |
| HOLD022B | 16 | 410 | 65 | 47 | 269 |
| HOLD022C | 17 | 415 | 65 | 58 | 331 |
| HOLD022S | 15 | 380/375 | 65 | 40 | 228 |
| HOND001B | 13 | 360/355 | 61/70 | 52 | 297 |
| HOND002B | 13.5 | 420 | 72/79 | 40 | 229 |
| HYUND003B | 17 | 407 | 148 | 33 | 189 |
| IMAZ001B | 16 | 395 | 102 | 49 | 280 |
| JEEP003B | 15 | 432/436 | 65/100 | 37 | 211 |
| JEEP006B | 14 | 380/375 | 62/102 | 32 | 183 |
| JEEP007B | 15 | 440/435 | 66/100 | 36 | 206 |
| JEEP008B | 16 | 345/335 | 72 | 35 | 200 |
| JEEP012B | 15 | 420/410 | 98 | 39 | 223 |
| JEEP012C | 15 | 440/430 | 98 | 38 | 217 |
| JEEP013B | 16 | 370/360 | 75 | 43 | 246 |
| JEEP014B | 16.5 | 375 | 82 | 78 | 446 |
| JEEP014C | 16.5 | 382 | 82 | 78 | 446 |
| JEEP015B | 17 | 323 | 85/115 | 38 | 217 |
| JEEP016B | 15.5 | 468 | 70/102 | 38 | 217 |
| JEEP017B | 15 | 460/450 | 73.5/103 | 32 | 183 |

| Part Number | Material | Free Height | End I/D | Spring Rate N/mm | Spring Rate lb/in |
|-------------|----------|-------------|----------|------------------|-------------------|
| JEEP017C | 15.5 | 460/450 | 73.5/103 | 36 | 206 |
| JEEP018A | 15.5 | 388 | 52/103 | 40 | 229 |
| JEEP018B | 16 | 388 | 52/103 | 45 | 257 |
| JEEP019B | 15 | 500 | 73/103 | 32 | 183 |
| JEEP020B | 16 | 417 | 56/103 | 43 | 246 |
| JEEP021EA | 17 | 420 | 58.5/95 | 61 | 349 |
| JEEP025B | 15.5 | 448 | 65/88 | 57 | 326 |
| JEEP025C | 15.5 | 463 | 65/88 | 57 | 326 |
| JEEP026B | 20 | 368 | 55/90 | 114 | 650 |
| JEEP026C | 21 | 365 | 55/90 | 154 | 879 |
| JEEP029A | 14 | 443 | 74/102 | 27 | 154 |
| JEEP029B | 14 | 455/450 | 74/102 | 27 | 154 |
| JEEP029C | 14 | 475/480 | 74/102 | 27 | 154 |
| JEEP030A | 15 | 388/393 | 71/78 | 28 | 160 |
| JEEP030C | 16 | 415/420 | 71/78 | 36 | 206 |
| JEEP031B | 15 | 505 | 74/102 | 27 | 154 |
| JEEP032B | 16 | 520 | 65/130 | 29 | 166 |
| JEEP032C | 17 | 525 | 65/130 | 36 | 206 |
| JEEP032D | 19 | 520 | 65/130 | 44 | 251 |
| JEEP030B | 16 | 395/400 | 71/78 | 31 | 177 |
| KIA007B | 16 | 387 | 79/129 | 35 | 201 |
| LADA001B | 16 | 285 | 92 | 89 | 509 |
| LADA002B | 14 | 435 | 100 | 32 | 183 |
| LAND005B | 17 | 400 | 118 | 41.1 | 535 |
| LAND006B | 20 | 405 | 134 | 81 | 462 |
| LAND006C | 21 | 440 | 134 | 81.9 | 468 |
| LAND007B | 16 | 390/382 | 118 | 41 | 234 |
| LAND008B | 17 | 440 | 134 | 36.6 | 209 |
| LAND009B | 16 | 405/395 | 117 | 36 | 206 |
| LAND011B | 17 | 425/420 | 117 | 46-53 | 262-302 |
| LAND011C | 18 | 425/420 | 118 | 56-64 | 319-365 |
| LAND014B | 15 | 410/390 | 117 | 30 | 171 |
| LAND019B | 17 | 415 | 90 | 83 | 474 |
| LAND019C | 17 | 427 | 90 | 83 | 474 |
| LAND020B | 21 | 402 | 80/100 | 82 | 469 |
| LAND020C | 21 | 415 | 80/100 | 88 | 503 |
| MAH003B | 15 | 405 | 97 | 46 | 263 |

Coil Springs

| Part Number | Material | Free Height | End I/D | Spring Rate N/mm | Spring Rate lb/in |
|-------------|-----------------|-------------|-----------|------------------|-------------------|
| MERC015B | 14.5 | 495/485 | 110 | 28 | 160 |
| MERC016B | 18 | 445/433 | 140 | 28-44 | 159-251 |
| MERC020B | 15 | 498 | 111 | 30.2 | 172 |
| MERC021B | 12, 15, 16 & 18 | 470 | 140 | 20-40 | 114-228 |
| MITS020B | 17 | 405/400 | 145 | 34 | 194 |
| MITS020C | 18 | 420 | 148 | 39 | 223 |
| MITS022B | 16 | 410/400 | 145 | 27 | 154 |
| MITS025B | 17 | 390 | 124 | 45 | 257 |
| MITS034B | 16 | 367 | 140 | 35 | 200 |
| MITS035B | 14 | 315/305 | 120 | 40 | 229 |
| MITS038B | 19 | 323 | 72/93 | 141 | 806 |
| MITS038C | 19 | 336 | 72/93 | 141 | 806 |
| MITS039A | 21 | 330/320 | 113 | 136 | 777 |
| MITS039B | 21 | 350/340 | 113 | 136-166 | 777-948 |
| MITS039C | 22 | 335 | 113.5 | 162-196 | 925-1119 |
| MITS040A | 17 | 325 | 64/93 | 105 | 600 |
| MITS040B | 18 | 325 | 64/92 | 110 | 628 |
| MITS040C | 18 | 330 | 64/92 | 110 | 628 |
| MITS040S | 18 | 310 | 64/93 | 118 | 674 |
| MITS042A | 17 | 380 | 145 | 32 | 183 |
| MITS042B | 17 | 403 | 145 | 32 | 183 |
| MITS042C | 18 | 342 | 92/67 | 110 | 628 |
| MITS042S | 17 | 360 | 145 | 32 | 183 |
| MITS045B | 18 | 335 | 92/67 | 110 | 628 |
| MITS045C | 18 | 335 | 92/67 | 110 | 628 |
| NISS007B | 16 | 415/400 | 89/122 | 36.9 | 211 |
| NISS008B | 17 | 490/480 | 139 | 33 | 189 |
| NISS009B | 17 | 410/387 | 87/122 | 46 | 263 |
| NISS009C | 18 | 415/398 | 89/122 | 58 | 331 |
| NISS010B | 19 | 468/448 | 139 | 50 | 286 |
| NISS010C | 19 | 488/470 | 139 | 46 | 263 |
| NISS018B | 14 | 427 | 106 | 34 | 194 |
| NISS020B | 19 | 490/480 | 139 | 50 | 286 |
| NISS020C | 20 | 475/458 | 139 | 60 | 343 |
| NISS020D | 22 | 475/453 | 139 | 85 | 486 |
| NISS024B | 17 | 425/410 | 87/122 | 46 | 263 |
| NISS026B | 18 | 484/469 | 87/122 | 48 | 274 |
| NISS027B | 20 | 535/521 | 139 | 52 | 297 |
| NISS027C | 21 | 552/540 | 139 | 70 | 400 |
| NISS034B | 16 | 400 | 119/146.5 | 28 | 160 |
| NISS035B | 15 | 370 | 126 | 29 | 166 |
| NISS038B | 15 | 325 | 134/146 | 36 | 206 |
| NISS039B | 15 | 325 | 114/146 | 36 | 206 |
| NISS040A | 16 | 375 | 81 | 89 | 508 |
| NISS040B | 17 | 370 | 81 | 97 | 554 |
| NISS040C | 17 | 380 | 81 | 97 | 554 |
| NISS040D | 17.5 | 380 | 81 | 96.7 | 552 |
| NISS042B | 19 | 443 | 119 | 75 | 429 |

| Part Number | Material | Free Height | End I/D | Spring Rate N/mm | Spring Rate lb/in |
|-------------|----------|-------------|------------|------------------|-------------------|
| NISS042C | 20 | 443 | 119 | 90 | 514 |
| NISS043B | 19 | 525/510 | 87/122 | 48 | 274 |
| NISS044B | 21 | 590/575 | 139 | 49 | 280 |
| NISS044C | 22/18 | 585/570 | 139/132 | 74 | 422 |
| NISS045A | 20 | 373 | 101 | 135 | 771 |
| NISS045B | 20 | 385 | 101 | 135 | 771 |
| NISS045C | 20 | 390 | 101 | 135 | 771 |
| NISS045EA | 21 | 385 | 101 | 154 | 878 |
| NISS045EA2 | 21 | 380 | 100 | 176 | 105 |
| NISS046A | 21 | 515 | 119 | 90 | 514 |
| NISS046B | 21 | 522 | 119 | 90 | 514 |
| NISS046C | 21.5 | 528 | 119 | 99 | 566 |
| NISS046EA | 22 | 525 | 121 | 97 | 556 |
| NISS046EA1 | 23 | 533 | 121 | 119 | 679 |
| NISS046EA2 | 23 | 528 | 119 | 140 | 800 |
| NISS058A | 16 | 445 | 84/121.5 | 35-45 | 200-256 |
| NISS058B | 16 | 445 | 84/121.5 | 35-60 | 200-342 |
| NISS058C | 18 | 445 | 84/121 | 57 | 325 |
| NISS058D | 18.5 | 445 | 85/122 | 74 | 423 |
| RAM015A | 19 | 405 | 70/85 | 103 | 588 |
| RAM015B | 19 | 410 | 70/85 | 105 | 599 |
| RAM015C | 19 | 410 | 70/85 | 113 | 645 |
| RAM016A | 16 | 485 | 65/111.6 | 37 | 211 |
| RAM016B | 17 | 495 | 65/112 | 44 | 251 |
| RAM016C | 19 | 505 | 65/112 | 63 | 359 |
| REN001B | 13.5 | 410 | 99.5/117.5 | 30 | 171 |
| REN002B | 14 | 395 | 99/117 | 35 | 200 |
| SSANG002B | 16 | 410 | 116 | 41 | 234 |
| SSANG003B | 17 | 312 | 60/99 | 91 | 519 |
| SSANG003C | 17 | 319 | 60/99 | 93 | 531 |
| SSANG004B | 15 | 375 | 114.1 | 42 | 239 |
| SSANG004C | 16 | 375 | 114 | 50 | 285 |
| SSANG006B | 15 | 395 | 114.1 | 42 | 239 |
| SSANG006C | 16 | 395 | 114 | 50 | 285 |
| SSANG010B | 17 | 298 | 65/88 | 123 | 702 |
| SUB001B | 15 | 350 | 121/143 | 31 | 177 |
| SUB002B | 15.5 | 345/340 | 128 | 38.28 | 219 |
| SUB003B | 15.5 | 355 | 123/144 | 30 | 171 |
| SUB004B | 15 | 365 | 99/135 | 39 | 223 |
| SUB005B | 16 | 298 | 124/144 | 53 | 301 |
| SUB006B | 13.5 | 343 | 84 | 50 | 284 |
| SUB014B | 13 | 390 | 83.6/77.6 | 35 | 199 |
| SUZ003B | 16 | 280 | 70/80 | 102 | 582 |
| SUZ004B | 12 | 345 | 70/82 | 25.4 | 145 |
| SUZ005B | 16 | 290 | 80.5/70.5 | 103 | 589 |
| SUZ006B | 13 | 340 | 72/82 | 33 | 189 |
| SUZ008B | 11 | 325/320 | 70/82 | 27 | 154 |
| SUZ009B | 12 | 372 | 75/82.5 | 27 | 154 |

Coil Springs

| Part Number | Material | Free Height | End I/D | Spring Rate N/mm | Spring Rate lb/in |
|-------------|----------|-------------|----------|------------------|-------------------|
| SUZ009C | 12 | 387 | 75.5/82 | 27 | 154 |
| SUZ010B | 12 | 340/320 | 75/84 | 30.9 | 176 |
| SUZ010C | 12.5 | 363/343 | 75/84 | 36 | 205 |
| SUZ011B | 12 | 335 | 75/84 | 30.9 | 176 |
| SUZ011C | 12.5 | 350 | 75/84 | 36 | 205 |
| SUZ013B | 12.5 | 345 | 62/80 | 33 | 189 |
| SUZ015B | 16 | 320 | 72/82 | 86 | 491 |
| SUZ016B | 12.5 | 360 | 62/80 | 33 | 189 |
| SUZ017B | 16 | 340 | 72/82 | 86 | 491 |
| SUZ018B | 14 | 360 | 63/96 | 35 | 200 |
| SUZ019B | 16 | 381 | 125 | 42 | 240 |
| SUZ019C | 16 | 395 | 125 | 42 | 240 |
| SUZ020A | 16.5 | 363 | 72 | 72 | 440 |
| SUZ020B | 17 | 368 | 72 | 88 | 503 |
| SUZ020C | 17 | 378 | 72 | 88 | 503 |
| TOY012C | 19 | 515/520 | 84/119 | 49 | 280 |
| TOY013B | 18 | 485/495 | 108/140 | 40 | 229 |
| TOY013C | 20 | 490/497 | 108/140 | 57 | 326 |
| TOY013D | 21 | 490/495 | 108/140 | 72 | 411 |
| TOY017A | 16 | 470 | 90 | 54-60 | 308-342 |
| TOY017B | 16 | 463 | 90 | 59 | 337 |
| TOY017EA | 18 | 450 | 90 | 88.9 | 507-619 |
| TOY017S | 16 | 455 | 90 | 54-60 | 308-342 |
| TOY018B | 14 | 395/380 | 86/100 | 35 | 200 |
| TOY019B | 16 | 420/405 | 86/125 | 38.2 | 218 |
| TOY023B | 16 | 395/390 | 103/133 | 31 | 177 |
| TOY023C | 17 | 375/370 | 103/134 | 38.2 | 218 |
| TOY024B | 17 | 480/485 | 81/116 | 41 | 234 |
| TOY024C | 17 | 500/505 | 82/117 | 41 | 234 |
| TOY025B | 18 | 473/483 | 108/139 | 40 | 229 |
| TOY025C | 19 | 460/475 | 107/139 | 48 | 274 |
| TOY025D | 22 | 470/478 | 108/140 | 70 | 400 |
| TOY038B | 16 | 348/357 | 67/76 | 108 | 617 |
| TOY038C | 17 | 357 | 67/76 | 133 | 760 |
| TOY039A | 15 | 398 | 74/114 | 31-36 | 177-205 |
| TOY039B | 15 | 410 | 74/114 | 31-36 | 177-206 |
| TOY039C | 17 | 385 | 74/114 | 45-51 | 256-291 |
| TOY046A | 16 | 470 | 86/100 | 50 | 286 |
| TOY046B | 17 | 463 | 86/100 | 57 | 325 |
| TOY046C | 17.5 | 465 | 85.5/100 | 60 | 342 |
| TOY046D | 18 | 455 | 85/100 | 71 | 405 |
| TOY046EA | 19 | 500 | 100/85 | 76 | 434 |
| TOY046EA1 | 20 | 490 | 99/84 | 93 | 532 |
| TOY048B | 14 | 438 | 100 | 34 | 194 |
| TOY048C | 14.5 | 428 | 100 | 39 | 223 |
| TOY049B | 17 | 450 | 87/125 | 34 | 194 |
| TOY049C | 18 | 440 | 87/125 | 44 | 251 |

| Part Number | Material | Free Height | End I/D | Spring Rate N/mm | Spring Rate lb/in |
|-------------|----------|-------------|------------|------------------|-------------------|
| TOY055A | 16.5 | 380 | 66/76 | 106 | 606 |
| TOY055B | 17 | 380 | 66/76 | 117 | 669 |
| TOY055C | 18 | 373 | 66/76 | 143 | 817 |
| TOY055EA | 19 | 365 | 66/76 | 171 | 975 |
| TOY055EA1 | 19 | 365 | 66/76 | 171 | 975 |
| TOY056A | 16.5 | 400 | 83.5/130.5 | 41 | 234 |
| TOY056B | 17 | 395 | 83/130 | 49 | 280 |
| TOY056C | 18 | 392 | 85/129 | 62 | 354 |
| TOY060B | 20 | 614/622 | 84/119 | 44 | 251 |
| TOY061B | 21 | 627/637 | 108/140 | 43 | 246 |
| TOY061C | 22 | 565/572 | 108/140 | 68 | 388 |
| TOY063A | 19 | 455/445 | 74/89 | 102 | 583 |
| TOY063B | 19 | 475/465 | 74/89 | 102 | 583 |
| TOY063C | 19 | 485/475 | 74/89 | 102 | 583 |
| TOY063EA | 20 | 445/435 | 89/73 | 117 | 668 |
| TOY063EA1 | 21 | 435 | 74/89 | 136 | 775 |
| TOY063EA2 | 22 | 430 | 87/73 | 186 | 1064 |
| TOY063S | 19 | 425/415 | 74/89 | 113 | 645 |
| TOY064A | 19 | 440/425 | 108/144 | 47 | 269 |
| TOY064B | 19 | 470/455 | 108/144 | 47 | 269 |
| TOY064C | 21 | 465/475 | 108/144 | 65 | 371 |
| TOY064D | 22 | 465 | 107/144 | 80 | 456 |
| TOY064EA | 20 | 475/465 | 108/144 | 50 | 286 |
| TOY064EA1 | 24 | 427 | 105/144 | 113 | 645 |
| TOY064EA2 | 25 | 435 | 108/140 | 126 | 718 |
| TOY064S | 18 | 457/442 | 108/144 | 42 | 240 |
| TOY065A | 18 | 390 | 66/76 | 126 | 720 |
| TOY065B | 18 | 382 | 66/76 | 136 | 775 |
| TOY065C | 18 | 380 | 66/76 | 145 | 827 |
| TOY067B | 18 | 300 | 82/122 | 90 | 514 |
| TOY069B | 17 | 420 | 83/130 | 48 | 274 |
| TOY070B | 19.5 | 430 | 66/89 | 132 | 754 |
| TOY070C | 19.5 | 437 | 66/89 | 132 | 754 |
| TOY070EA | 22 | 390 | 63/88 | 189 | 1079 |
| TOY072B | 18 | 365 | 135/107 | 59 | 336 |
| TOY072EA | 19 | 380 | 107/135 | 69 | 393 |
| TOY076C | 18 | 388 | 140 | 58 | 331 |
| TOY079B | 17.5 | 525 | 101/86 | 54 | 308 |
| TOY080A | 15 | 415 | 114 | 30 | 171 |
| TOY082A | 15 | 442 | 94 | 96 | 548 |
| TROL001B | 15.5 | 390 | 94 | 58 | 331 |
| TROL002B | 15.5 | 430 | 102 | 39 | 223 |
| TROL003B | 15.5 | 395 | 95 | 52 | 297 |
| TROL004B | 15 | 435 | 99 | 38 | 216 |
| VOLKS001B | 17.5 | 330 | 65.5/90 | 119 | 679 |
| VOLKS001C | 18 | 330 | 65.5/90 | 137 | 783 |
| VOLKS001D | 18 | 335 | 65.5/90 | 137 | 783 |

Leaf Springs

LEAF SPRING MEASUREMENT REFERENCE

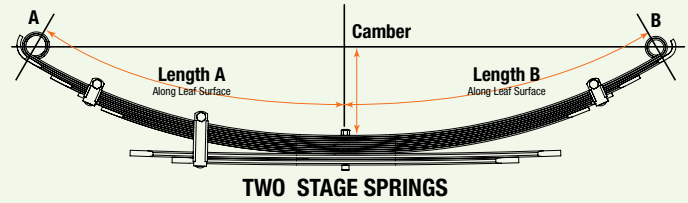
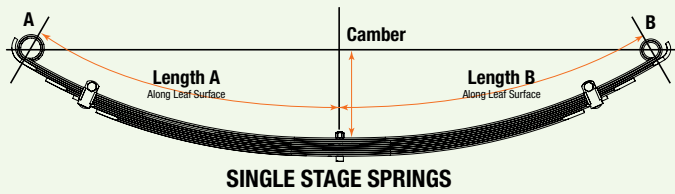

| Part Number | Length A | Length B | Camber | Leaves | Width | Eye A | Eye B |
|-------------|----------|----------|---------|--------|-------|-------|-------|
| FOR002A | 585 | 735 | 120 | 5+2 | 60 | 55 | 32 |
| FOR002B | 585 | 735 | 130 | 5+2 | 60 | 55 | 32 |
| FOR002C | 585 | 735 | 145 | 6+2 | 60 | 55 | 32 |
| HOLD004A | 555 | 650 | 240/230 | 5+1 | 60 | 40 | 30 |
| HOLD004B | 555 | 650 | 250/240 | 5+1 | 60 | 40 | 30 |
| HOLD004C | 555 | 650 | 250/240 | 6+1 | 60 | 40 | 30 |
| HOLD006A | 608 | 602 | 205 | 4+1 | 60 | 40 | 30 |
| HOLD006B | 608 | 602 | 205 | 5+1 | 60 | 40 | 30 |
| HOLD006C | 608 | 602 | 205 | 6+2 | 60 | 40 | 30 |
| HOLD006D | 608 | 602 | 205 | 6+2 | 60 | 40 | 30 |
| HOLD021A | 607 | 763 | 145 | 5+2 | 60 | 40 | 30 |
| HOLD021B | 607 | 763 | 155 | 5+2 | 60 | 40 | 30 |
| HOLD021C | 607 | 763 | 160 | 6+2 | 60 | 40 | 30 |
| HOLD021D | 607 | 758 | 160 | 6+2 | 60 | 40 | 30 |
| HOLD023B | 650 | 650 | 175 | 5+2 | 60 | 40 | 30 |
| HOLD023C | 650 | 650 | 175 | 6+2 | 60 | 40 | 30 |
| IMAZ002B | 650 | 700 | 165 | 8 | 60 | 42 | 32 |
| ISL6010 | 270 | 270 | 48 | 1 | 60 | | |
| JEEP004B | 585 | 725 | 195/175 | 5+2 | 63 | 64.5 | 44.3 |
| JMC002B | 610 | 690 | 150 | 5+2 | 60 | 40 | 30 |
| JMC002C | 610 | 690 | 130 | 5+2 | 60 | 40 | 30 |
| MAH002B | 612 | 610 | 185 | 5+2 | 70 | 35 | 35 |
| MAZDA006A | 530 | 670 | 165 | 5+1 | 60 | 32 | 32 |
| MAZDA006B | 530 | 670 | 150 | 6+2 | 60 | 32 | 32 |
| MAZDA006C | 530 | 670 | 165 | 6+2 | 60 | 32 | 32 |
| MAZDA006D | 530 | 670 | 150 | 7+2 | 60 | 32 | 32 |
| MAZDA041A | 590 | 730 | 140 | 4+2 | 60 | 40 | 32 |
| MAZDA041B | 590 | 730 | 140 | 4+2 | 60 | 40 | 32 |
| MAZDA041C | 590 | 720 | 140 | 5+2 | 60 | 40 | 32 |
| MAZDA041D | 590 | 720 | 130 | 6+2 | 60 | 40 | 32 |
| MTS018A | 520 | 685 | 200 | 4+1 | 70 | 32 | 28 |
| MTS018B | 515 | 685 | 195 | 4+1 | 70 | 32 | 28 |
| MTS018C | 515 | 685 | 190 | 5+1 | 70 | 32 | 28 |
| MTS041A | 515 | 685 | 140 | 4+1 | 70 | 32 | 28 |

| Part Number | Length A | Length B | Camber | Leaves | Width | Eye A | Eye B |
|-------------|----------|----------|---------|--------|-------|-------|-------|
| MTS041B | 515 | 685 | 145 | 4+1 | 70 | 32 | 28 |
| MTS041C | 515 | 685 | 155 | 5+1 | 70 | 32 | 28 |
| MTS047A | 550 | 775 | 140 | 5+1 | 60 | 40 | 28 |
| MTS047B | 550 | 775 | 140 | 5+1 | 60 | 40 | 28 |
| MTS047C | 550 | 775 | 140 | 5+2 | 60 | 40 | 28 |
| NISS003B | 560 | 550 | 185/170 | 6 | 60 | 22 | 33 |
| NISS004B | 605 | 835 | 250/235 | 8 | 60 | 33 | 33 |
| NISS005B | 560 | 550 | 185/170 | 6 | 60 | 40 | 33 |
| NISS011C | 550 | 550 | 180/170 | 7 | 70 | 40 | 35 |
| NISS012C | 595 | 825 | 217/200 | 7+2 | 70 | 35 | 35 |
| NISS012D | 600 | 830 | 240/225 | 7+3 | 70 | 35 | 35 |
| NISS014A | 565 | 635 | 145/135 | 4+2 | 60 | 40 | 33 |
| NISS014B | 565 | 635 | 130/120 | 4+1 | 60 | 40 | 33 |
| NISS014C | 565 | 635 | 130/120 | 5+1 | 60 | 40 | 33 |
| NISS021B | 650 | 580 | 200 | 8 | 60 | 33 | 40 |
| NISS041B | 670 | 735 | 195 | 5+1 | 60 | 40 | 33 |
| NISS041C | 670 | 730 | 190 | 6+1 | 60 | 40 | 33 |
| NISS041D | 670 | 730 | 180 | 7+2 | 60 | 40 | 33 |
| NISS047B | 635 | 715 | 195 | 7+1 | 60 | 40 | 33 |
| NISS049B | 700 | 650 | 230 | 5+1 | 60 | 40 | 33 |
| NISS057B | 670 | 605 | 175 | 5+2 | 60 | 40 | 33 |
| NISS057C | 670 | 605 | 175 | 6+2 | 60 | 40 | 33 |
| SSANG005B | 710 | 720 | 200 | 5+1 | 70 | 56 | 28 |
| SSANG005C | 710 | 720 | 200 | 6+1 | 70 | 56 | 28 |
| SUZ001B | 480 | 470 | 120/110 | 5 | 50 | 30 | 40 |
| SUZ002B | 510 | 520 | 175/155 | 4+1 | 50 | 40 | 30 |
| TOY001B | 510 | 610 | 160 | 7 | 70 | 25 | 25 |
| TOY002B | 510 | 620 | 180 | 7 | 70 | 25 | 25 |
| TOY003C | 660 | 660 | 230 | 7+3 | 70 | 30 | 30 |
| TOY004B | 510 | 610 | 160 | 7 | 70 | 35 | 35 |
| TOY004C | 502 | 603 | 155 | 8 | 70 | 35 | 35 |
| TOY005C | 655 | 675 | 230 | 7+3 | 70 | 35 | 35 |
| TOY006B | 555 | 555 | 150 | 7 | 70 | 35 | 35 |
| TOY006C | 555 | 555 | 175 | 8 | 70 | 35 | 35 |

Leaf Springs

| Part Number | Length A | Length B | Camber | Leaves | Width | Eye A | Eye B |
|-------------|----------|----------|---------|--------|-------|-------|-------|
| TOY006D | 550 | 550 | 175 | 9 | 70 | 35 | 35 |
| TOY007A | 570 | 655 | 230/220 | 7 | 70 | 35 | 35 |
| TOY007B | 570 | 645 | 220/205 | 6+1 | 70 | 35 | 35 |
| TOY007C | 565 | 655 | 230/220 | 7+1 | 70 | 35 | 35 |
| TOY008B | 555 | 590 | 180 | 7 | 70 | 35 | 35 |
| TOY008C | 555 | 590 | 180 | 8 | 70 | 35 | 35 |
| TOY009B | 610 | 730 | 210 | 6+2 | 70 | 40 | 40 |
| TOY009C | 610 | 720 | 210 | 7+2 | 70 | 40 | 40 |
| TOY009D | 605 | 720 | 215 | 8+2 | 70 | 40 | 40 |
| TOY009E | 610 | 720 | 220 | 9+2 | 70 | 40 | 40 |
| TOY010B | 575 | 575 | 135/115 | 5 | 60 | 30 | 30 |
| TOY010C | 575 | 575 | 130/110 | 6 | 60 | 30 | 30 |
| TOY011B | 530 | 670 | 200 | 4+2 | 60 | 30 | 30 |
| TOY011C | 530 | 670 | 210 | 5+2 | 60 | 30 | 30 |
| TOY027A | 560 | 740 | 200 | 6+2 | 60 | 40 | 30 |
| TOY027B | 560 | 740 | 200 | 4+2 | 60 | 40 | 30 |
| TOY027C | 560 | 740 | 200 | 5+2 | 60 | 40 | 30 |
| TOY034B | 505 | 630 | 205 | 7 | 70 | 35 | 35 |
| TOY044C | 535 | 670 | 150 | 4+2 | 60 | 40 | 40 |
| TOY047A | 695 | 815 | 245 | 7+2 | 70 | 40 | 40 |
| TOY047B | 698 | 815 | 235 | 8+2 | 70 | 40 | 40 |
| TOY047C | 698 | 815 | 235 | 9+2 | 70 | 40 | 40 |
| TOY047D | 698 | 815 | 235 | 9+2 | 70 | 40 | 40 |

| Part Number | Length A | Length B | Camber | Leaves | Width | Eye A | Eye B |
|-------------|----------|----------|---------|--------|-------|-------|-------|
| TOY047E | 698 | 815 | 250 | 9+2 | 70 | 40 | 40 |
| TOY057A | 610 | 690 | 170 | 6+2 | 60 | 40 | 30 |
| TOY057B | 610 | 690 | 190 | 4+2 | 60 | 40 | 30 |
| TOY057C | 610 | 690 | 190 | 5+2 | 60 | 40 | 30 |
| TOY057D | 610 | 690 | 200 | 6+2 | 60 | 40 | 30 |
| TOY062B | 620 | 785 | 245 | 7+2 | 70 | 40 | 40 |
| TOY062C | 620 | 785 | 245 | 8+2 | 70 | 40 | 40 |
| TOY062D | 625 | 785 | 250 | 10+2 | 70 | 40 | 40 |
| TOY066B | 705 | 705 | 185/175 | 5+2 | 60 | 40 | 40 |
| TOY066C | 705 | 705 | 185/180 | 6+2 | 60 | 40 | 40 |
| TOY068B | 590 | 685 | 200 | 4+2 | 60 | 40 | 30 |
| TOY068C | 590 | 685 | 190 | 6+2 | 60 | 40 | 30 |
| TOY071B | 800 | 815 | 200 | 4+2 | 60 | 40 | 40 |
| TOY071C | 800 | 815 | 200 | 5+2 | 60 | 40 | 40 |
| TOY073B | 655 | 755 | 130 | 3 | 70 | 70 | 60 |
| TOY073C | 655 | 755 | 130 | 4 | 70 | 70 | 60 |
| TOY077A | 700 | 700 | 170 | 5+2 | 60 | 40 | 30 |
| TOY077B | 700 | 700 | 170 | 5+2 | 60 | 40 | 30 |
| TOY077C | 700 | 700 | 170 | 6+2 | 60 | 40 | 30 |
| TOY077D | 700 | 700 | 170 | 6+2 | 60 | 40 | 30 |
| VOLKS002B | 750 | 760 | 245 | 5+2 | 70 | 60 | 46 |
| VOLKS002C | 750 | 760 | 255 | 6+2 | 70 | 60 | 46 |

LEAF SPRING SPARE PARTS

| | |
|-----------|---|
| 099 | 3/8" x 4" Centre Bolt |
| 098 | 5/16" x 4" Centre Bolt |
| 635 | 3/8" x 4" Centre Bolt - Extended Head |
| CLINER001 | Plastic Clip Liner |
| AFPAD001 | Plastic Anti-Friction Pad (Oval Locator) |
| AFPAD002 | Plastic Anti-Friction Pad (Round Locator) |
| IWEDGE04 | 1 Degree Wedge Kit |
| IWEDGE08 | 2 Degree Wedge Kit |
| IWEDGE10 | 3 Degree Wedge Kit |
| IWEDGE12 | 4 Degree Wedge Kit |



Torsion and Sway Bars

TORSION AND SWAY BAR MEASUREMENT REFERENCE

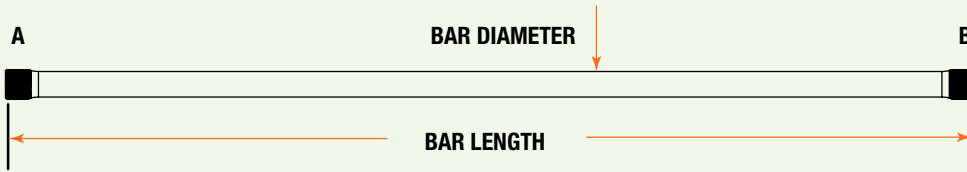

| Part Number | Length | Diameter | A End Spline Count | B End Spline Count |
|-------------|--------|----------|--------------------|--------------------|
| HOLD005A | 1000 | 26 | 43 | 43 |
| HOLD007 | 1000 | 26 | 47 | 47 |
| HOLD009 | 1220 | 30 | 47 | 47 |
| HOLD010 | 1144 | 30 | 47 | 47 |
| HYUND004 | 1275 | 29 | 43 | 43 |
| MAZDA005 | 924 | 26 | 40 | 40 |
| MAZDA014 | 1025 | 27 | 40 | 40 |
| MAH001 | 1063 | 28 | 43 | 43 |
| MITSO13 | 1278 | 26 | 39 | 40 |
| MITSO15C | 1370 | 28 | 39 | 40 |
| MITSO19 | 1308 | 28 | 39 | 40 |
| MITSO31 | 1165 | 24 | 40 | 40 |

| Part Number | Length | Diameter | A End Spline Count | B End Spline Count |
|-------------|--------|----------|--------------------|--------------------|
| NISS013 | 1203 | 26 | 39 | 39 |
| NISS017 | 1232 | 26 | 39 | 39 |
| NISS025 | 894 | 26 | 39 | 39 |
| NISS048 | 866 | 26 | 39 | 39 |
| SSANG001 | 1040 | 26 | 40 | 40 |
| TOY026 | 1063 | 26 | 43 | 40 |
| TOY042 | 1212 | 27 | 40 | 40 |
| TOY050 | 1160 | 32 | 46 | 46 |
| TOY051 | 1210 | 32 | 46 | 46 |

| SWAY BAR SPARE PARTS | SWAY BAR | REPLACEMENT BUSH | |
|--|------------------|-------------------|---|
| To Suit Toyota Landcruiser 200 Front | ISB200F | ISBB20038R | Rubber Sway Bar Chassis Bush 38mm |
| To Suit Toyota Landcruiser 200 Rear | ISB200R | ISBB20033R | Rubber Sway Bar Axle Mounting Bush 33mm |
| | | ISBB200REB | Rubber Sway Bar End Bush |
| To Suit Nissan Patrol Y62 Front | ISB600F | ISBB60036R | Rubber Sway Bar Chassis Bush 36mm |
| To Suit Nissan Patrol Y62 Rear | ISB600R | ISBB60027R | Rubber Sway Bar Axle Mounting Bush 27mm |
| To Suit Toyota Landcruiser 70 Front Diesel | ISB789FW | ISBB78933R | Rubber Sway Bar Chassis Bush 33mm |
| | | ISBB789REB | Rubber Sway Bar End Bush |
| | | ISBB789DB | Chassis Mounting D Bracket |
| To Suit Toyota Landcruiser 70 Front Petrol | ISB789FWP | ISBB78933R | Rubber Sway Bar Chassis Bush 33mm |
| | | ISBB789REB | Rubber Sway Bar End Bush |
| | | ISBB789DB | Chassis Mounting D Bracket |
| To Suit Toyota Landcruiser 70 Rear | ISB789RW | ISBB78930R | Rubber Sway Bar Axle Mounting Bush 30mm |
| | | ISBB789REB | Rubber Sway Bar End Bush |
| | | ISBB789DB | Axle Mounting D Bracket |
| | | ISBB789RBK | Chassis Mounting Bracket Set |
| To Suit Toyota Hilux 2015+ Front | ISB80F | ISBB8033R | Rubber Sway Bar Chassis Bush 33mm |

Shock Absorbers



SHOCK ABSORBER MEASUREMENT REFERENCE

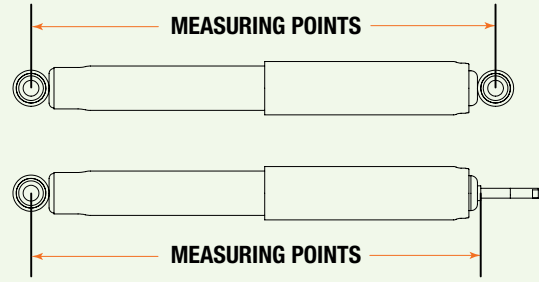

| Part Number | Extended (mm) | Compressed (mm) | Upper Mount Type | Upper Replacement | Lower Mount Type | Lower Replacement | Part Number | Extended (mm) | Compressed (mm) | Upper Mount Type | Upper Replacement | Lower Mount Type | Lower Replacement |
|-------------|---------------|-----------------|------------------|-------------------|------------------|-------------------|-------------|---------------|-----------------|------------------|-------------------|------------------|-------------------|
| 12075GR | 487 | 296 | ST1 | 2244K | ST1 | 2244K | 12658GR | 510 | 320 | ST1 | 2244K | ET83 | - |
| 12076GR | 583 | 347 | B1 | 632RF | ST1 | 2244K | 12661GR | 535 | 329 | ST1 | 2244K | B2 | 635RK |
| 12080GR | 552 | 332 | ST38 | 656RK | ST38 | 656RK | 12665GR | 565 | 345 | ST1 | 2244AK | CB7 | CB7 |
| 12081GR | 631 | 388 | B2 | 635RK | B2 | 635RK | 12666GR | 560 | 348 | CB20 | CB20 | B5 | - |
| 12082GR | 342 | 232 | ST1 | 2244K | CB7 | CB7 | 12667GR | 381 | 250 | ST1 | 2244K | ET17 | ET17 |
| 12083GR | 505 | 310 | STEM 57 X M14 | - | CLEVIS | - | 12669GR | 560 | 348 | CB20 | CB20 | ET24 | - |
| 12085GR | 485 | 298 | ST1 | 2244K | B1 | 632RF | 12670GR | 562 | 351 | B5 | - | ET24 | - |
| 12086GR | 500 | 313 | B1 | 632RF | B1 | 632RF | 12671GR | 627 | 372 | ST1 | 2244K | B1 | 632RF |
| 12087GR | 350 | 236 | ST1 | 2244K | ET17 | ET17 | 12682GR | 618 | 373 | ST38 | 656RK | B2 | 635RK |
| 12088GR | 368 | 245 | ST1 | 2244K | ET113 | ET113 | 12682GRC | 618 | 373 | ST38-1 | ST38-1 | ET38 | ET38 |
| 12089GR | 510 | 320 | ST1 | 2244K | ET83 | - | 12682GRP | 618 | 373 | ST38-1 | ST38-1 | ET38 | ET38 |
| 12091GR | 510 | 310 | ST38 | 656RK | ST38 | 656RK | 12683GR | 615 | 365 | ST38 | 656RK | ST38 | 656RK |
| 12094GR | 655 | 402 | B2 | 635RK | B2 | 635RK | 12691GR | 462 | 343 | ST38 | 656RK | ET153 | ET153 |
| 12095GR | 631 | 382 | ET104 | ET104 | ET69 | ET69 | 12696GR | 570 | 347 | ET161 | - | ST38 | 656RK |
| 12635GR | 485 | 307 | B1 | 632RF | B1 | 632RF | 12697GR | 520 | 322 | B2 | 635RK | ST38 | 656RK |
| 12636GR | 588 | 357 | B1 | 632RF | B1 | 632RF | 12698GR | 624 | 381 | B1 | 632RF | B1 | 632RF |
| 12636GRP | 588 | 362 | B1 | 632RF | B1 | 632RF | 12710GR | 564 | 432 | STEM 95 X M12 | ST710RK | ET153-1 | ET153-1 |
| 12637GR | 577 | 348 | ST1 | 2244K | B2 | 635RK | 12711GR | 318 | 206 | STEM 68 X M10 | - | - | - |
| 12639GR | 484 | 298 | ST1 | 2244K | ET17 | ET17 | 12712GR | 570 | 357 | ET19 | - | ET141 | - |
| 12640GR | 564 | 343 | B2 | 635RK | ST38 | 656RK | 12712LGR | 700 | 416 | ET19 | - | ET141 | - |
| 12643GR | 412 | 261 | ST6 | 2244AK | ET17 | ET17 | 12713GR | 470 | 325 | STEM 86 X M10 | - | ET158 | ET158 |
| 12644GR | 510 | 320 | ET153 | - | ET36 | - | 12714GR | 575 | 351 | ST1 | ST714RK | ET159 | - |
| 12645GR | 531 | 333 | B1 | 632RF | ET142 | - | 12715GR | 423 | 305 | STEM 71 X M10 | - | ET158-1 | ET158-1 |
| 12645GRS | 520 | 328 | B1 | 632RF | ET142 | - | 12716GR | 389 | 284 | STEM 85 X M12 | 656R | ET153-2 | ET153-2 |
| 12646GR | 495 | 310 | ST1 | 2244K | ET113 | ET113 | 12717GR | 575 | 352 | B1 | 632RF | ET34 | ET34 |
| 12648GR | 640 | 385 | B2 | 635RK | ST1 | 2244K | 12718GR | 380 | 265 | ET159 | - | ET159 | - |
| 12650GR | 593 | 364 | B2 | 635RK | B2 | 635RK | 12720GR | 600 | 435 | STEM 69 X M14 | ST720RK | ET113-1 | ET113-1 |
| 12652GR | 540 | 333 | B1 | 632RF | B1 | 632RF | 12721GR | 607 | 382 | STEM 28 X M14 | - | CLEVIS | - |

| Part Number | Extended (mm) | Compressed (mm) | Upper Mount Type | Upper Replacement | Lower Mount Type | Lower Replacement |
|-------------|---------------|-----------------|------------------|-------------------|------------------|-------------------|
| 12722GR | 545 | 343 | ET83 | - | ET83 | - |
| 12725GR | 615 | 460 | STEM 56 X M12 | - | FORK | - |
| 12726GR | 602 | 365 | ET69 | ET69 | ET69 | ET69 |
| 12727GR | 512 | 378 | STEM 65 X M12 | ST727RK | ET154 | ET154 |
| 12728GR | 608 | 369 | B1 | 632RF | ET34 | ET34 |
| 12729GR | 550 | 339 | B1 | 632RF | B1 | 632RF |
| 12729GRP | 550 | 343 | B1 | 632RF | B1 | 632RF |
| 12730GR | 560 | 425 | STEM 68 X M12 | ST710RK | ET153-1 | ET153-1 |
| 12731GR | 540 | 333 | ET69 | ET69 | ET69 | ET69 |
| 12732GR | 580 | 380 | STEM 33 X M12 | - | ET162 | - |
| 12735GR | 830 | 667 | STEM 35 X M12 | - | CLEVIS | - |
| 12738GR | 830 | 667 | STEM 35 X M12 | - | CLEVIS | - |
| 12740GR | 452 | 299 | STEM 81 X M12 | - | ET158-2 | ET158-2 |
| 12742GR | 564 | 356 | ST42 | - | ET160 | ET160 |
| 12743GR | 600 | 362 | ST10 | ST10RK | ET38 | ET38 |
| 12744GR | 609 | 361 | ST10 | ST10RK | ET17 | ET17 |
| 12745GR | 495 | 359 | STEM 64 X M12 | ST710RK | ET153-1 | ET153-1 |
| 12746GR | 605 | 360 | ST1 | 2244K | ET17 | ET17 |
| 12747GR | 625 | 400 | STEM 45 X M14 | - | CLEVIS | - |
| 12748GR | 711 | 450 | STEM 45 X M14 | - | CLEVIS | - |
| 12749GR | 530 | 325 | ET69 | ET69 | B1 | 632RF |
| 12750GR | 562 | 425 | STEM 68 X M12 | ST710RK | ET153-3 | ET153-3 |
| 12751GR | 575 | 325 | ST38 | 656RK | ET69 | 632RF |
| 12751LGR | 650 | 382 | ST38 | 656RK | ET69 | 632RF |
| 12752GR | 617 | 374 | CB35 | CB35 | ET69 | 632RF |
| 12752LGR | 665 | 396 | CB35 | CB35 | ET69 | 632RF |
| 12755GR | 625 | 381 | ET113 | - | ET113 | - |
| 12756GR | 432 | 293 | ET173 | - | ET173 | - |
| 12757GR | 650 | 390 | CB34 | - | ET34 | - |
| 12759GR | 440 | 277 | ST1 | 2244K | ET17 | ET17 |

| Part Number | Extended (mm) | Compressed (mm) | Upper Mount Type | Upper Replacement | Lower Mount Type | Lower Replacement |
|-------------|---------------|-----------------|------------------|-------------------|------------------|-------------------|
| 12760GR | 495 | 310 | ET177 | ET177 | ET177 | ET177 |
| 12764GR | 440 | 307 | STEM 70 X M12 | - | ET153 | ET153 |
| 12765GR | 625 | 380 | ET163 | - | ET163 | - |
| 12774GR | 550 | 336 | ST6 | 2244AK | CB7 | CB7 |
| 12775GR | 575 | 357 | ET61 | - | ET65 | - |
| 12776GR | 587 | 362 | ET172 | - | CB34 | - |
| 12777GR | 587 | 362 | ET172 | - | ET172 | - |
| 12780GR | 613 | 450 | STEM 68 X M12 | ST710RK | ET113-1 | ET113-1 |
| 12781GR | 650 | 384 | ST38 | ST21RK | ET38-2 | ET38-2 |
| 12791GR | 310 | 217 | ST1 | 2244K | ET17 | ET17 |
| 12795GR | 447 | 290 | ST21 | ST21RK | ET153 | - |
| 12796GR | 619 | 369 | ST21 | ST21RK | B2 | 635RK |
| 12797GR | 415 | 295 | STEM 64 X M12 | ST710RK | ET153-1 | ET153-1 |
| 12804GR | 535 | 345 | CB159 | - | ET38 | ET38 |
| 12805GR | 570 | 351 | B1 | 632RF | B2 | 635RK |
| 12807GR | 451 | 344 | STEM 48 X M10 | - | CB160 | - |
| 12808GR | 673 | 404 | ET164 | - | ET164 | - |
| 12809GR | 461 | 354 | STEM 55 X M10 | - | CB160 | - |
| 12810GR | 605 | 375 | ET164 | - | ET164 | - |
| 12811GR | 630 | 390 | ET113 | - | ST39 | ST39 |
| 12812GR | 597 | 375 | ST39 | - | ET174 | ET174 |
| 12823GR | 478 | 360 | STEM 28 X M10 | - | ET174 | ET174 |
| 12824GR | 525 | 320 | STEM 90 X M10 | - | ET175 | ET175 |
| 12825GR | 545 | 330 | STEM 90 X M10 | - | ET175 | ET175 |
| 12826GR | 580 | 365 | ET176 | ET176 | ET176 | ET176 |
| 12827GR | 496 | 376 | STEM 65 X M12 | - | ET155 | ET155 |
| 12853GR | 550 | 437 | STEM 65 X M12 | ST22RK | ET153-1 | ET153-1 |
| 12885GR | 555 | 411 | STEM 46 X M12 | N/A | ET885 | ET885 |
| 12886GR | 650 | 398 | ET886 | ET886 | ET886 | ET886 |
| 12886GRC | 650 | 398 | ET886 | ET886 | ET886 | ET886 |

Shock Absorbers



| Part Number | Extended (mm) | Compressed (mm) | Upper Mount Type | Upper Replacement | Lower Mount Type | Lower Replacement |
|-------------|---------------|-----------------|------------------|-------------------|------------------|-------------------|
| 24080FE | 552 | 332 | ST38 | 656RK | ST38 | 656RK |
| 24081FE | 631 | 388 | B2 | 635RK | B2 | 635RK |
| 24081FEP | 631 | 388 | B2 | 635RK | B2 | 635RK |
| 24082FE | 342 | 230 | ST1 | 2244K | CB7 | CB7 |
| 24087FE | 349 | 235 | ST1 | 2244K | ET17 | ET17 |
| 24088FE | 368 | 246 | ST1 | 2244K | ET113 | ET113 |
| 24091FE | 510 | 310 | ST38 | 656RK | ST38 | 656RK |
| 24091FEP | 510 | 310 | ST38 | 656RK | ST38 | 656RK |
| 24091LFE | 557 | 354 | ST38 | 656RK | ST38 | 656RK |
| 24091LFE1 | 597 | 353 | ST38 | 656RK | ST38 | 656RK |
| 24091LFEP | 557 | 354 | ST38 | 656RK | ST38 | 656RK |
| 24094FE | 658 | 402 | B2 | 635RK | B2 | 635RK |
| 24094LFE | 718 | 429 | B2 | 635RK | B2 | 635RK |
| 24094LFE1 | 760 | 450 | B2 | 635RK | B2 | 635RK |
| 24094LFEC | 718 | 429 | B2 | 635RK | B2 | 635RK |
| 24094LFEP | 718 | 429 | B2 | 635RK | B2 | 635RK |
| 24095FE | 630 | 385 | ET104 | ET104 | ET69 | ET69 |
| 24635FE | 485 | 310 | B1 | 632RF | B1 | 632RF |
| 24636FE | 587 | 361 | B1 | 632RF | B1 | 632RF |
| 24636FEP | 587 | 361 | B1 | 632RF | B1 | 632RF |
| 24637FE | 577 | 350 | ST1 | 2244K | B2 | 635RK |
| 24639FE | 484 | 303 | ST1 | 2244K | ET17 | ET17 |
| 24640FE | 564 | 343 | B2 | 635RK | ST38 | 656RK |
| 24643FE | 412 | 266 | ST6 | 2244AK | ET17 | ET17 |
| 24644FE | 510 | 325 | ET153 | - | ET36 | - |
| 24645FE | 531 | 333 | B1 | 632RF | ET142 | - |
| 24645FEC | 531 | 333 | B1 | 632RF | ET142 | - |
| 24645FES | 520 | 328 | B1 | 632RF | ET142 | - |
| 24646FE | 495 | 310 | ST1 | 2244K | ET113 | ET113 |
| 24648FE | 640 | 385 | B2 | 635RK | ST1 | 2244K |
| 24650FE | 592 | 366 | B2 | 635RK | B2 | 635RK |
| 24650FEP | 592 | 366 | B2 | 635RK | B2 | 635RK |
| 24652FE | 540 | 337 | B1 | 632RF | B1 | 632RF |
| 24661FE | 533 | 331.5 | ST1 | 2244K | B2 | 635RK |
| 24665FE | 564 | 346 | ST1 | 2244K | CB7 | CB7 |
| 24666FE | 565 | 346 | CB20 | CB20 | B5 | - |
| 24667FE | 382 | 251 | ST1 | 2244AK | ET17S | ET17S |
| 24682FE | 618 | 373 | ST38 | 656RK | B2 | 635RK |
| 24682FEC | 618 | 373 | ST38-1 | ST38-1 | ET38 | ET38 |
| 24682FEP | 618 | 373 | ST38-1 | ST38-1 | ET38 | ET38 |
| 24682LFE | 670 | 398 | ST38 | 656RK | B2 | 635RK |
| 24682LFE1 | 730 | 428 | ST38 | 656RK | B2 | 635RK |
| 24683FE | 615 | 365 | ST38 | 656RK | ST38 | 656RK |
| 24683LFE | 670 | 390 | ST38 | 656RK | ST38 | 656RK |
| 24683LFE1 | 730 | 420 | ST38 | 656RK | ST38 | 656RK |
| 24691FE | 462 | 343 | ST38 | 656RK | ET153 | ET153 |
| 24696FE | 570 | 347 | ET161 | - | ST38 | 656RK |
| 24697FE | 520 | 322 | B2 | 635RK | ST38 | 656RK |
| 24698FE | 626 | 381 | B1 | 632RF | B1 | 632RF |
| 24698FEC | 626 | 381 | B1 | 632RF | B1 | 632RF |

| Part Number | Extended (mm) | Compressed (mm) | Upper Mount Type | Upper Replacement | Lower Mount Type | Lower Replacement |
|-------------|---------------|-----------------|------------------|-------------------|------------------|-------------------|
| 24698FEP | 626 | 381 | B1 | 632RF | B1 | 632RF |
| 24710FE | 540 | 408 | STEM 95 X M12 | ST710RK | ET153-1 | ET153-1 |
| 24713FE | 470 | 325 | STEM 86 X M10 | - | ET158 | ET158 |
| 24715FE | 423 | 305 | STEM 71 X M10 | - | ET158-1 | ET158-1 |
| 24716FE | 389 | 284 | STEM 85 X M12 | 656R | ET153-2 | ET153-2 |
| 24717FE | 577 | 356 | B1 | 632RF | ET34 | ET34 |
| 24717FEC | 577 | 356 | B1 | 632RF | ET34 | ET34 |
| 24717FEP | 575 | 356 | B1 | 632RF | ET34 | ET34 |
| 24718FE | 380 | 265 | ET159 | - | ET159 | - |
| 24720FE | 600 | 435 | STEM 69 X M14 | ST720RK | ET113-1 | ET113-1 |
| 24727FE | 512 | 378 | STEM 65 x M12 | ST727RK | ET154 | ET154 |
| 24728FE | 608 | 373 | B1 | 632RF | ET34 | ET34 |
| 24728FEP | 608 | 373 | B1 | 632RF | ET34 | ET34 |
| 24729FE | 550 | 348 | B1 | 632RF | B1 | 632RF |
| 24729FEP | 550 | 348 | B1 | 632RF | B1 | 632RF |
| 24730FE | 560 | 425 | STEM 68 X M12 | ST710RK | ET153-1 | ET153-1 |
| 24732FE | 580 | 374 | STEM 33 X M12 | - | ET162 | - |
| 24740FE | 452 | 299 | STEM 81 X M12 | - | ET158-2 | ET158-2 |
| 24742FE | 564 | 356 | ST42 | - | ET160 | ET160 |
| 24743FE | 600 | 365 | ST10 | ST10RK | B2 | 635RK |
| 24744FE | 610 | 365 | ST10 | ST10RK | ET17 | ET17 |
| 24745FE | 495 | 359 | STEM 64 x M12 | ST710RK | ET153-1 | ET153-1 |
| 24746FE | 605 | 366 | ST1 | 2244K | ET17 | ET17 |
| 24750FE | 562 | 425 | STEM 68 X M12 | ST710RK | ET153-3 | ET153-3 |
| 24776FE | 587 | 367 | ET172 | - | CB34 | - |
| 24777FE | 587 | 367 | ET172 | - | ET172 | - |
| 24780FE | 613 | 450 | STEM 68 x M12 | ST710RK | ET113-1 | ET113-1 |
| 24781FE | 650 | 387 | ST38 | ST21RK | ET38-2 | ET38-2 |
| 24788FE | 560 | 341 | ET113 | - | ST39 | ST39 |
| 24789FE | 576 | 349 | ST39 | ST39 | ET174 | ET174 |
| 24795FE | 447 | 290 | ST21 | ST21RK | ET153 | - |
| 24796FE | 615 | 369 | ST21 | ST21RK | B2 | 635RK |
| 24804FE | 535 | 345 | CB159 | - | ET38 | ET38 |
| 24805FE | 570 | 355 | B1 | 632RF | B2 | 635RK |
| 24811FE | 630 | 390 | ET113 | - | ST39 | ST39 |
| 24812FE | 597 | 375 | ST39 | ST39 | ET174 | ET174 |
| 24827FE | 496 | 376 | STEM 65 XM12 | - | ET155 | ET155 |
| 24840FE | 635 | 450 | STEM 31 x M14 | - | CLEVIS | - |
| 24842FE | 570 | 375 | B2 | 635RK | B2 | 635RK |
| 24842FEC | 570 | 375 | B2 | 635RK | B2 | 635RK |
| 24845FE | 517 | 359 | STEM 64 x M12 | ST710RK | ET153-1 | ET153-1 |
| 24851FE | 640 | 456 | ET180 | - | ET181 | - |
| 24852FE | 480 | 491 | ET180 | - | ET181 | - |
| 24853FE | 550 | 437 | STEM 65 X M12 | ST72R K | ET153-1 | ET153-1 |
| 24883FE | 620 | 453 | STEM 63 X M14 | ST883RK | ET183 | ET183 |
| 24884FE | 620 | 410 | STEM 81 X M14 | ST884RK | ET38 | ET38 |
| 24885FE | 555 | 411 | STEM 46 X M12 | N/A | ET886 | ET886 |
| 24886FE | 650 | 398 | ET886 | ET886 | ET886 | ET886 |
| 24886FEC | 650 | 398 | ET886 | ET886 | ET886 | ET886 |



| Part Number | Extended (mm) | Compressed (mm) | Upper Mount Type | Upper Replacement | Lower Mount Type | Lower Replacement | Seal Service Kit | Seat Insulator | Adjusting Rings |
|-------------|---------------|-----------------|------------------|-------------------|------------------|-------------------|------------------|----------------|-----------------|
| 45080FE | 552 | 358 | ST38 | 656RK | ST38 | 656RK | 45SK7220 | | |
| 45081FE | 631 | 400 | B2 | 635RK | B2 | 635RK | 45SK7220 | | |
| 45081FEC | 631 | 400 | B2 | 635RK | B2 | 635RK | 45SK7220 | | |
| 45091FE | 510 | 318 | ST38 | 656RK | ST38 | 656RK | 45SK7220 | | |
| 45091FEP | 510 | 318 | ST38 | 656RK | ST38 | 656RK | 45SK7220 | | |
| 45091LFE | 557 | 341 | ST38 | 656RK | ST38 | 656RK | 45SK7220 | | |
| 45091LFE1 | 597 | 361 | ST38 | 656RK | ST38 | 656RK | 45SK7220 | | |
| 45091LFE3 | 860 | 492 | ST38 | 656RK | ST38 | 656RK | 45SK7220 | | |
| 45091LFEP | 557 | 341 | ST38 | 656RK | ST38 | 656RK | 45SK7220 | | |
| 45094FE | 658 | 416 | B2 | 635RK | ET38 | ET38 | 45SK7220 | | |
| 45094FEC | 658 | 416 | B2 | 635RK | ET38 | ET38 | 45SK7220 | | |
| 45094LFE | 718 | 446 | B2 | 635RK | ET38 | ET38 | 45SK7220 | | |
| 45094LFE1 | 760 | 467 | B2 | 635RK | ET38 | ET38 | 45SK7220 | | |
| 45094LFE3 | 860 | 516 | B2 | 635RK | ET38 | ET38 | 45SK7220 | | |
| 45095FE | 630 | 398 | ET104 | ET104 | ET69 | ET69 | 45SK7220 | | |
| 45095FEC | 630 | 398 | ET104 | ET104 | ET69 | ET69 | 45SK7220 | | |
| 45635FE | 485 | 323 | B1 | 632RF | B1 | 632RF | 45SK7220 | | |
| 45636FE | 587 | 375 | B1 | 632RF | B1 | 632RF | 45SK7220 | | |
| 45636FEC | 587 | 375 | B1 | 632RF | B1 | 632RF | 45SK7220 | | |
| 45637FE | 577 | 363 | ST1 | 2244K | B2 | 635R | 45SK7220 | | |
| 45640FE | 564 | 357 | ET38 | ET38 | ST38 | 656RK | 45SK7220 | | |
| 45648FE | 640 | 395 | B2 | 635RK | ST1 | 2244K | 45SK7220 | | |
| 45650FE | 592 | 380 | B2 | 635RK | B2 | 635RK | 45SK7220 | | |
| 45650FEC | 592 | 380 | B2 | 635RK | B2 | 635RK | 45SK7220 | | |
| 45650FEP | 592 | 380 | B2 | 635RK | B2 | 635RK | 45SK7220 | | |
| 45652FE | 540 | 354 | B1 | 632RF | B1 | 632RF | 45SK7220 | | |
| 45652FEC | 540 | 354 | B1 | 632RF | B1 | 632RF | 45SK7220 | | |
| 45661FE | 533 | 343 | ST1 | 2244K | ET38 | ET38 | 45SK7220 | | |
| 45667FE | 382 | 257 | ST1 | 2244K | ET17 | ET17 | 45SK6520 | | |
| 45682FE | 618 | 383 | ST38 | 656RK | ET38 | ET38 | 45SK7220 | | |
| 45682FEC | 618 | 383 | ST38-1 | ST38-1 | ET38 | ET38 | 45SK7220 | | |
| 45682FEP | 618 | 383 | ST38-1 | ST38-1 | ET38 | ET38 | 45SK7220 | | |
| 45682LFE | 670 | 409 | ST38 | 656RK | ET38 | ET38 | 45SK7220 | | |
| 45682LFE1 | 730 | 439 | ST38 | 656RK | ET38 | ET38 | 45SK7220 | | |
| 45682LFE3 | 860 | 504 | ST38 | 656RK | ET38 | ET38 | 45SK7220 | | |
| 45683FE | 615 | 370 | ST38 | 656RK | ST38 | 656RK | 45SK7220 | | |
| 45683LFE | 670 | 397 | ST38 | 656RK | ST38 | 656RK | 45SK7220 | | |
| 45683LFE1 | 730 | 427 | ST38 | 656RK | ST38 | 656RK | 45SK7220 | | |
| 45691FE | 462 | 342 | ST38 | 656RK | ET153 | ET153 | 45SK6520 | 45RSS001 | 45STAR001 |
| 45698FE | 626 | 394 | B1 | 632RF | B1 | 632RF | 45SK7220 | | |
| 45698FEC | 626 | 394 | B1 | 632RF | B1 | 632RF | 45SK7220 | | |
| 45710FE | 540 | 408 | STEM 95 x M12 | ST710RK | ET153-1 | ET153-1 | 45SK6520 | 45RSS001 | 45STAR001 |
| 45715FE | 442 | 315 | STEM 71 X M10 | - | ET158-1 | ET158-1 | 45SK6520 | 45RSS001 | 45STAR001 |
| 45716FE | 389 | 283 | STEM 86 x M12 | 656RK | ET153-2 | ET153-2 | 45SK7220 | 45RSS004 | 45STAR002 |
| 45716LFE | 402 | 287 | STEM 86 x M12 | 656RK | ET153-2 | ET153-2 | 45SK7220 | 45RSS004 | 45STAR002 |

Shock Absorbers



| Part Number | Extended (mm) | Compressed (mm) | Upper Mount Type | Upper Replacement | Lower Mount Type | Lower Replacement | Seal Service Kit | Seat Insulator | Adjusting Rings |
|-------------|---------------|-----------------|------------------|-------------------|------------------|-------------------|------------------|----------------|-----------------|
| 45717FE | 572 | 373 | B1 | 632RF | ET34 | ET34 | 45SK7220 | | |
| 45717FEC | 572 | 373 | B1 | 632RF | ET34 | ET34 | 45SK7220 | | |
| 45720FE | 600 | 435 | STEM 71 x M14 | ST720RK | ET113-1 | ET113-1 | 45SK7218 | 45RSS002 | 45TAR002 |
| 45727FE | 512 | 378 | STEM 65 x M12 | ST727RK | ET154 | ET154 | 45SK7220 | 45RSS005 | 45TAR002 |
| 45728FE | 608 | 389 | B1 | 632RF | ET34 | ET34 | 45SK7220 | | |
| 45728FEC | 608 | 389 | B1 | 632RF | ET34 | ET34 | 45SK7220 | | |
| 45729FE | 445 | 372 | B1 | 632RF | B1 | 632RF | | | |
| 45729FEC | 445 | 372 | B1 | 632RF | B1 | 632RF | | | |
| 45729FEP | 445 | 372 | B1 | 632RF | B1 | 632RF | | | |
| 45730FE | 560 | 425 | STEM 68 X M12 | ST710RK | ET153-1 | ET153-1 | 45SK6520 | 45RSS001 | 45TAR001 |
| 45732FE | 580 | 380 | STEM 33 X M12 | - | ET162 | - | 45SK7218 | | |
| 45732FEC | 580 | 380 | STEM 33 X M12 | - | ET162 | - | 45SK7218 | | |
| 45740FE | 452 | 302 | STEM 81 x M12 | - | ET158-2 | ET158-2 | 45SK7220 | 45RSS003 | 45TAR002 |
| 45742FE | 564 | 357 | ST42 | - | ET160 | ET160 | 45SK7220 | | |
| 45743FE | 600 | 376 | ST10 | ST10RK | ET38 | ET38 | 45SK7220 | | |
| 45744FE | 610 | 379 | ST10 | ST10RK | ET17 | ET17 | 45SK7220 | | |
| 45745FE | 495 | 359 | STEM 64 x M12 | ST710RK | ET153-1 | ET153-1 | 45SK6520 | 45RSS001 | 45TAR001 |
| 45746FE | 605 | 397 | ST1 | 2244K | ET17 | ET17 | 45SK6520 | | |
| 45746FEC | 605 | 397 | ST1 | 2244K | ET17 | ET17 | 45SK6520 | | |
| 45750FE | 562 | 425 | STEM 68 x M12 | ST710RK | ET153-3 | ET153-3 | 45SK6520 | 45RSS001 | 45TAR001 |
| 45751FE | 575 | 361 | ST38 | 656RK | B1 | 632RF | 45SK7220 | | |
| 45751LFE | 650 | 399 | ST38 | 656RK | B1 | 632RF | 45SK7220 | | |
| 45752FE | 617 | 393 | CB35 | CB35 | B1 | 632RF | 45SK7220 | | |
| 45752LFE | 665 | 417 | CB35 | CB35 | B1 | 632RF | 45SK7220 | | |
| 45780FE | 613 | 450 | STEM 68 X M12 | ST710RK | ET113-1 | ET113-1 | 45SK7218 | 45RSS002 | 45TAR002 |
| 45781FE | 650 | 401 | ST21 | ST21RK | ET38-2 | ET38-2 | 45SK7220 | | |
| 45795FE | 447 | 295 | ST21 | ST21RK | ET38-1 | ET38-1 | 45SK7220 | | |
| 45796FE | 615 | 401 | ST21 | ST21RK | ET38 | ET38 | 45SK7220 | | |
| 45796FEP | 615 | 401 | ST21 | ST21RK | ET38 | ET38 | 45SK7220 | | |
| 45802FE | 755 | 471 | ET165 | - | ET165 | - | 45SK7220 | | |
| 45802LFE | 860 | 524 | ET165 | - | ET165 | - | 45SK7220 | | |
| 45803FE | 710 | 449 | ET165 | - | ET165 | - | 45SK7220 | | |
| 45827FE | 496 | 376 | STEM 65 X M12 | - | ET155 | ET155 | 45SK7218 | 45RSS005 | 45TAR002 |
| 45845FE | 517 | 359 | STEM 64 x M12 | ST710RK | ET153-1 | ET153-1 | 45SK6520 | 45RSS001 | 45TAR001 |
| 45851FE | 640 | 456 | ET180 | - | ET181 | - | 45SK6520 | | |
| 45851FEC | 640 | 456 | ET180 | - | ET181 | - | 45SK6520 | | |
| 45851LFE | 680 | 421 | ET180 | - | ET181 | - | 45SK6520 | | |
| 45851LFEC | 680 | 421 | ET180 | - | ET181 | - | 45SK6520 | | |
| 45852FEC | 640 | 498 | ET180 | - | ET181 | - | 45SK6520 | | |
| 45852LFE | 730 | 453 | ET180 | - | ET181 | - | 45SK6520 | | |
| 45852LFEC | 730 | 453 | ET180 | - | ET181 | - | 45SK6520 | | |
| 45853FE | 550 | 437 | STEM 65 X M12 | ST72RK | ET153-1 | ET153-1 | 45SK6520 | 45RSS001 | 45TAR001 |
| 45854FE | 678 | 446 | ET153-1 | - | ET153-1 | - | 45SK7220 | | |
| 45854FEC | 678 | 446 | ET153-1 | - | ET153-1 | - | 45SK7220 | | |
| 45854FEP | 678 | 446 | ET153-1 | - | ET153-1 | - | 45SK7220 | | |



| Part Number | Extended (mm) | Compressed (mm) | Upper Mount Type | Upper Replacement | Lower Mount Type | Lower Replacement | Seal Service Kit | Seat Insulator | Adjusting Rings |
|-------------|---------------|-----------------|------------------|-------------------|--------------------|-------------------|------------------|----------------|-----------------|
| 45855FE | 542 | 389 | STEM x 30 x M12 | - | CLEVIS 72.5 x 16.5 | - | 45SK6520 | | |
| 45855LFE | 558 | 389 | STEM x 30 x M12 | - | CLEVIS 72.5 x 16.5 | - | 45SK6520 | | |
| 45856FE | 678 | 446 | ET153-2 | ET153-2 | ET153-3 | - | 45SK7220 | | |
| 45856FEC | 678 | 446 | ET153-2 | ET153-2 | ET153-3 | - | 45SK7220 | | |
| 45856LFE | 700 | 457 | ET153-2 | ET153-2 | ET153-3 | - | 45SK7220 | | |
| 45856LFEC | 700 | 457 | ET153-2 | ET153-2 | ET153-3 | - | 45SK7220 | | |
| 45860FE | 561 | 412 | STEM 30 X M12 | - | CLEVIS 72 X 16.5 | - | 45SK6520 | | |
| 45860FEC | 700 | 426 | STEM 65 X M12 | - | ET153-3 | ET153-3 | 45SK7220 | | |
| 45862FE | 700 | 426 | STEM 65 X M12 | - | ET153-3 | ET153-3 | 45SK7220 | | |
| 45883FE | 620 | 453 | STEM 63 X M14 | ST883RK | ET183 | ET183 | 45SK7218 | | |
| 45884FE | 660 | 424 | STEM 81 X M14 | ST883RK | ET38 | ET38 | 45SK7220 | | |
| 45884FEP | 660 | 424 | STEM 81 X M14 | ST883RK | ET38 | ET38 | 45SK7220 | | |
| 45885FE | 555 | 411 | STEM 46 X M12 | N/A | ET885 | ET885 | 45SK6520 | | |
| 45886FE | 650 | 409 | ET886 | ET886 | ET886 | ET886 | 45SK7220 | | |
| 45886FEC | 650 | 409 | ET886 | ET886 | ET886 | ET886 | 45SK7220 | | |
| 45886FEP | 650 | 409 | ET886 | ET886 | ET886 | ET886 | 45SK7220 | | |

| Make | To Suit Model | Part No. | OEM Spring Seat Height |
|--------------------|--------------------------------|----------|------------------------|
| To Suit Ford | To Suit Ranger PX, PX II | 45727FE | 190mm |
| | To Suit Ranger PX III | 45827FE | 166mm |
| | To Suit Ranger Next-Gen | 45885FE | 193mm |
| To Suit Holden | To Suit Colorado / Trailblazer | 45745FE | 190mm |
| To Suit Isuzu | To Suit D-Max | 45745FE | 190mm |
| | To Suit D-Max | 45845FE | 195mm |
| To Suit Mazda | To Suit BT50 | 45727FE | 190mm |
| To Suit Mercedes | To Suit X-Class | 45716FE | 105mm |
| To Suit Mitsubishi | To Suit Triton | 45715FE | 210mm |
| To Suit Nissan | To Suit Navara D40 | 45716FE | 105mm |
| | To Suit Navara NP300 | 45716FE | 105mm |
| | To Suit Patrol Y62 | 45740FE | 130mm |

| Make | To Suit Model | Part No. | OEM Spring Seat Height |
|-----------------|------------------------------------|----------|------------------------|
| To Suit RAM | To Suit RAM 1500 DS | 45855FE | 185mm |
| To Suit Renault | To Suit Alaskan | 45716FE | 105mm |
| To Suit Toyota | To Suit Prado 90 / 95 | 45691FE | 163mm |
| | To Suit Hilux / Fortuner 2005-2014 | 45710FE | 229mm |
| | To Suit Hilux / Fortuner 2015+ | 45730FE | 224mm |
| | To Suit Prado 120 | 45710FE | 214mm |
| | To Suit Prado 150 2009-10/2017 | 45750FE | 214mm |
| | To Suit Prado 150 11/2017+ | 45710FE | 214mm |
| | To Suit FJ Cruiser / Tacoma | 45710FE | 214mm |
| | To Suit Landcruiser 200 | 45720FE | 220mm |
| | To Suit Landcruiser 300 | 45883FE | 237mm |
| | To Suit Tundra | 45780FE | 245mm with TOY063 Coil |

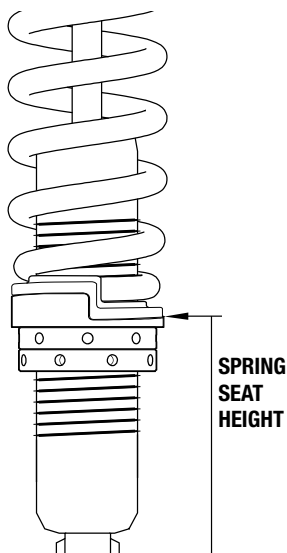

Foam Cell Pro Struts feature a threaded body for ride height adjustment. Use Ironman 4x4, P/N# ISHOCKTOOL001 wrench when making adjustments. It may be necessary to unload the spring tension before making adjustments.

When setting ride height use the OEM shock absorber as a reference for spring seat height, or refer table above.

Many independent suspension systems incorporating struts operate at a 2:1 motion ratio. For every 1mm of movement (compression or extension) at the strut, equates to 2mm movement when measured at the wheel. This MUST be considered when adjusting seat height. For example a 10mm seat height adjustment will provide 20mm change in ride height.

Independent suspension MUST maintain at least 60mm downward travel from ride height. Raising ride height too high can damage the suspension components, impair suspension operation and safety.



ISHOCKTOOL001 Multi-tool for shock absorber service and strut ride height adjustment

Steering Dampers

STEERING DAMPER MEASUREMENT REFERENCE

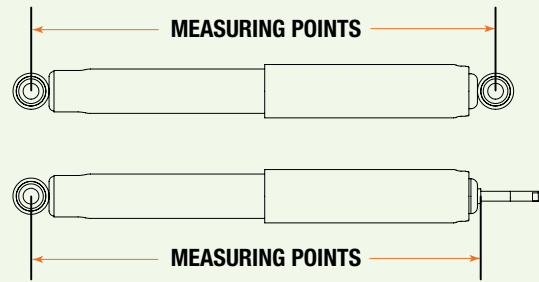

| Part Number | Extended (mm) | Compressed (mm) | Upper Mount Type | Upper Replacement | Lower Mount Type | Lower Replacement |
|-------------|---------------|-----------------|------------------|-------------------|------------------|-------------------|
| 3501 | 550 | 345 | B9 | B9MK | B9 | B9MK |
| 3502 | 655 | 394 | ET65 | - | ET65 | - |
| 3511 | 525 | 310 | ST1 | 2244K | ST1 | 2244K |
| 3517 | 609 | 368 | B6 | - | B6 | - |
| 3521 | 540 | 340 | ST1 | 2244K | B9 | B9MK |
| 3521S | 487 | 293 | ST1 | 2244K | ST1 | 2244K |
| 3522 | 541 | 331 | B1 | 632RF | B1 | 632RF |
| 3523 | 458 | 322 | B9 | B9MK | B9 | B9MK |
| 3524 | 648 | 423 | B9 | B9MK | B9 | B9MK |
| 3525 | 748 | 443 | B9 | B9MK | B9 | B9MK |

| Part Number | Extended (mm) | Compressed (mm) | Upper Mount Type | Upper Replacement | Lower Mount Type | Lower Replacement |
|-------------|---------------|-----------------|------------------|-------------------|------------------|-------------------|
| 3530 | 445 | 290 | ET17 | ET17 | ET17 | ET17 |
| 3532 | 677 | 439 | ST1 | 2244K | ET57 | - |
| 3533 | 613 | 368 | ET109 | - | B9 | B9MK |
| 3534 | 577 | 350 | ET17 | ET17 | B1 | 632RF |
| 3536 | 487 | 292 | ST1 | 2244K | ST1 | 2244K |
| 3540 | 480 | 298 | B1 | 632RF | ET65 | - |
| 3541 | 528 | 332 | ET65 | - | ET65 | - |
| 3542 | 622 | 419 | ET17 | - | B1 | - |
| 3543 | 725 | 520 | ET65 | - | ET65 | - |
| 3544 | 535 | 338 | ET65 | - | ET65 | - |

Shock Absorber Mount Types

SHOCK ABSORBER MOUNTS MEASUREMENT REFERENCES

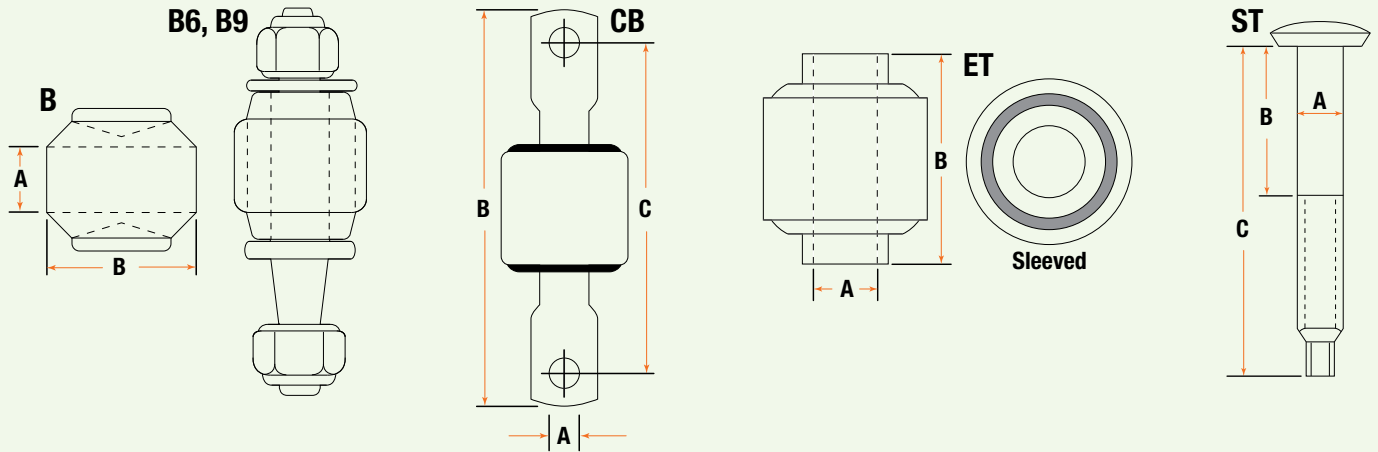

| Type | A Diameter | B Length | |
|---------|------------|----------|---------|
| B1 | 16 | 36 | |
| B2 | 19 | 43.5 | |
| B5 | 15.5 | 33 | |
| B6 | 16 | 36 | Adaptor |
| B9 | 16 | 36 | Adaptor |
| <hr/> | | | |
| CB20 | 13 | 95 | 77 |
| CB34 | 11 | 97 | 75 |
| CB35 | 10 | 90 | 80 |
| CB7 | 11.5 | 78 | 62 |
| CB159 | 10 | 116 | 95.5 |
| CB160 | 11.5 | 128 | 100 |
| <hr/> | | | |
| ET104 | 20 | 43 | |
| ET109 | 10 | 24.1 | |
| ET113 | 16 | 38.5 | |
| ET113-1 | 16 | 38.5 | Sleeved |
| ET141 | 12 | 41 | |
| ET142 | 16 | 36.5 | |
| ET153 | 14 | 40 | Sleeved |
| ET153-1 | 14 | 40 | Sleeved |
| ET153-2 | 14 | 41.5 | Sleeved |
| ET153-3 | 14 | 41.5 | Sleeved |
| ET154 | 16 | 38 | Sleeved |
| ET155 | 20 | 49.5 | Sleeved |
| ET158 | 14 | 50 | Sleeved |
| ET158-1 | 14 | 50 | Sleeved |
| ET158-2 | 14 | 50 | Sleeved |
| ET159 | 14 | 48 | Sleeved |
| ET160 | 14 | 53 | Sleeved |
| ET161 | 16 | 70 | |
| ET162 | 14 | 61.5 | Sleeved |

| Type | A Diameter | B Length | |
|--------|---------------|----------|---------|
| ET163 | 16 | 32.5 | Sleeved |
| ET164 | 14.5 | 43 | |
| ET165 | 20 | 55 | |
| ET17 | 12 | 31.5 | |
| ET172 | 12.4 | 43.5 | |
| ET173 | 13 | 42.5 | |
| ET174 | 12 | 38 | Sleeved |
| ET175 | 12.2 | 38 | Sleeved |
| ET176 | 16 | 38 | |
| ET177 | 12 | 32 | Sleeved |
| ET180 | 13 | 70 | |
| ET181 | 13 | 40 | |
| ET19 | 12 | 46 | |
| ET24 | 12.5 | 36 | |
| ET34 | 14 | 41.5 | |
| ET36 | 19 | 44 | |
| ET38 | 19 | 45.5 | |
| ET38-1 | 14 | 38 | |
| ET38-2 | 12 | 39 | |
| ET57 | 10 | 26.1 | |
| ET61 | 12 | 46 | |
| ET65 | 12 | 36 | Sleeved |
| ET69 | 12 | 40 | Sleeved |
| ET83 | 12 | 37.5 | Sleeved |
| <hr/> | | | |
| ST1 | 10 | 26 | 60 |
| ST10 | 12 | 39 | 64 |
| ST21 | 17 | 59 | 84 |
| ST38 | 14 | 43 | 70 |
| ST38-1 | 14 | 43 | 70 |
| ST42 | Rectangle M12 | 44 | 80 |
| ST6 | 11 | 34 | 65 |

Trim Packers

TRIM PACKER MEASUREMENT REFERENCE

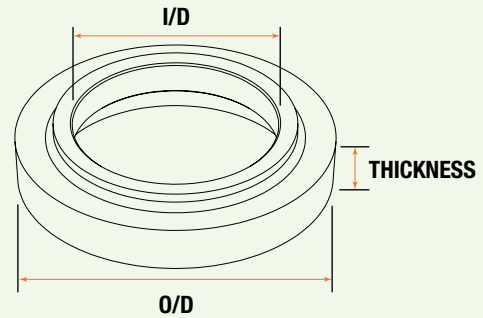

| Part Number | O/D | I/D | Thickness | Material |
|-------------|-----|-------|-----------|--------------|
| HILFR05 | 63 | 54.5 | 5 | Steel |
| HILFR05F | 63 | 60.5 | 5 | Steel |
| HILFR10 | 63 | 54.5 | 10 | Steel |
| HILFR10F | 63 | 60.5 | 10 | Steel |
| HILFR15 | 63 | 54.5 | 15 | Steel |
| HILFR15F | 63 | 60.5 | 15 | Steel |
| LC70F30 | 138 | 86 | 30 | Polyurethane |
| LCF20 | 160 | 114.5 | 20 | Polyurethane |
| LCF30 | 160 | 114.5 | 30 | Polyurethane |

| Part Number | O/D | I/D | Thickness | Material |
|-------------|-----|-------|-----------|--------------|
| LCPR20 | 168 | 108 | 20 | Polyurethane |
| LCPR25 | 168 | 108 | 25 | Polyurethane |
| LCR15 | 187 | 133.5 | 15 | Polyurethane |
| LCR30 | 187 | 133.5 | 30 | Polyurethane |
| PATF15 | 172 | 116 | 15 | Polyurethane |
| PATF30 | 172 | 116 | 30 | Polyurethane |
| PATR15 | 180 | 120 | 15 | Polyurethane |
| PATR30 | 180 | 120 | 30 | Polyurethane |

U-Bolts and Load Plus Helper Springs

U-BOLTS MEASUREMENT REFERENCE

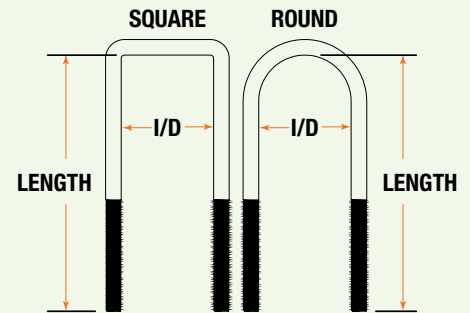

| Part Number | Type | Length | I/D | Thread | Tension Nm |
|-------------|--------|--------|-----|-----------------|------------|
| 415UBK | Round | 215 | 83 | M14 X 1.5 X 100 | 125 |
| 416UBK | Round | 230 | 83 | M14 X 1.5 X 100 | 125 |
| 416UBKL | Round | 250 | 83 | M14 X 1.5 X 100 | 125 |
| 417UBK | Round | 220 | 88 | M14 X 1.5 X 80 | 125 |
| 436UBK | Square | 230 | 73 | M14 X 1.5 X 100 | 125 |
| 437UBK | Square | 175 | 62 | M14 X 1.5 X 100 | 125 |
| 437UBKL | Square | 190 | 62 | M14 X 1.5 X 100 | 125 |
| 438UBK | Square | 200 | 66 | M14 X 1.5 X 100 | 125 |
| 449UBK | Square | 230 | 83 | M14 X 1.5 X 100 | 125 |
| 451UBK | Round | 190 | 75 | M12 X 1.5 X 75 | 75 |
| 452UBK | Square | 120 | 63 | M12 X 1.5 X 75 | 75 |
| 453UBK | Round | 230 | 97 | M14 X 1.5 X 100 | 125 |
| 512UBK | Round | 160 | 70 | M12 X 1.5 X 65 | 75 |

| Part Number | Type | Length | I/D | Thread | Tension Nm |
|-------------|--------|--------|-----|-----------------|------------|
| 654UBK | Round | 165 | 82 | M12 X 1.5 X 75 | 75 |
| 655UBK | Round | 140 | 70 | M12 X 1.5 X 65 | 75 |
| 668UBK | Square | 230 | 73 | M14 X 1.5 X 100 | 125 |
| 669UBK | Square | 230 | 73 | M14 X 1.5 X 100 | 125 |
| 670UBK | Round | 230 | 95 | M14 X 1.5 X 100 | 125 |
| 678UBK | Square | 200 | 62 | M14 X 1.5 X 70 | 125 |
| 788UBK | Square | 190 | 63 | M12 X 1.25 X 65 | 75 |
| 1100UBK | Round | 230 | 110 | M14 X 1.5 X 100 | 125 |
| 1100UBKL | Round | 265 | 110 | M14 X 1.5 X 100 | 125 |
| 1102UBK | Square | 155 | 72 | M12 X 1.5 X 65 | 75 |
| 1103UBK | Round | 185 | 72 | M14 X 1.5 X 100 | 125 |
| 1104UBK | Round | 200 | 83 | M14 X 1.5 X 100 | 125 |
| 1106UBK | Square | 205 | 92 | M14 x 1.5 x 75 | 125 |

LOAD PLUS HELPER SPRINGS

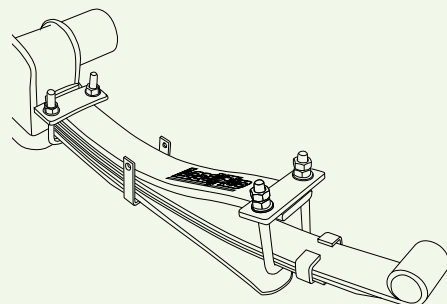

| Part Number | Width | Thickness | Length | Mounting Kit | U-Bolt |
|-------------|-------|-----------|--------|--------------|--------|
| LP1 | 60 | 12 | 425 | LP3-1 | LP3-2 |
| LP2 | 60 | 12 | 420 | LP3-1 | LP3-2 |
| LP3 | 60 | 12 | 442 | LP3-1 | LP3-2 |
| LP4 | 70 | 12 | 442 | LP4-1 | LP4-2 |

| Part Number | Width | Thickness | Length | Mounting Kit | U-Bolt |
|-------------|-------|-----------|--------|--------------|--------|
| LP5 | 50 | 8 | 310 | LP5-1 | LP5-2 |
| LP7 | 75 | 12 | 438 | LP7-1 | LP7-2 |
| LP9 | 70 | 16 | 435 | LP9-1 | LP9-2 |

Suspension Arm Rubber Bush Kits

WITH STANDARD RADIUS ARM BUSHES

| Model | Part Number | Contents | Position | Qty Per Kit |
|---|--------------|--------------|-----------------------|-------------|
| TO SUIT NISSAN PATROL Y60 GQ 1989 - On TO SUIT NISSAN PATROL Y61 GU WAGON Pre 2/2000 | 839RK | 832RT | Radius Arm - Diff | 4 |
| | | 833R | Radius Arm Chassis | 4 |
| | | 836RT | Trailing Arm | 8 |
| | | 834RT | Panhard Rod - Chassis | 2 |
| | | 840RT | Panhard Rod - Diff | 2 |
| TO SUIT NISSAN PATROL Y61 GU WAGON 2/2000 - On | 848RK | 832RT | Radius Arm - Diff | 4 |
| | | 833R | Radius Arm Chassis | 4 |
| | | 836RT | Trailing Arm | 8 |
| | | 848RT | Panhard Rod - Chassis | 2 |
| | | 840RT | Panhard Rod - Diff | 2 |
| TO SUIT TOYOTA LANDCRUISER 80/105 | 847RK | 832RT | Radius Arm - Diff | 4 |
| | | 846RT | Radius Arm Chassis | 2 |
| | | 844RT | Trailing Arm Upper | 4 |
| | | 843RT | Trailing Arm Lower | 4 |
| | | 841RT | Front Panhard Rod | 2 |
| | | 845RT | Rear Panhard Rod | 2 |

WITH 2° OFFSET RADIUS ARM BUSHES

| Model | Part Number | Contents | Position | Qty Per Kit |
|---|---------------|--------------|--------------------------|-------------|
| TO SUIT NISSAN PATROL Y60 GQ 1989 - On TO SUIT NISSAN PATROL Y61 GU WAGON Pre 2/2000 | 839CRK | 1144R | Radius Arm - Diff Offset | 4 |
| | | 833R | Radius Arm Chassis | 4 |
| | | 836RT | Trailing Arm | 8 |
| | | 834RT | Panhard Rod - Chassis | 2 |
| | | 840RT | Panhard Rod - Diff | 2 |
| TO SUIT NISSAN PATROL Y61 GU WAGON 2/2000 - On | 848CRK | 1144R | Radius Arm - Diff Offset | 4 |
| | | 833R | Radius Arm Chassis | 4 |
| | | 836RT | Trailing Arm | 8 |
| | | 848RT | Panhard Rod - Chassis | 2 |
| | | 840RT | Panhard Rod - Diff | 2 |
| TO SUIT TOYOTA LANDCRUISER 80/105 | 847CRK | 1144R | Radius Arm - Diff Offset | 4 |
| | | 846RT | Radius Arm Chassis | 2 |
| | | 844RT | Trailing Arm Upper | 4 |
| | | 843RT | Trailing Arm Lower | 4 |
| | | 841RT | Front Panhard Rod | 2 |
| | | 845RT | Rear Panhard Rod | 2 |

STRUT COMPRESSOR

Part No. IBSC7600

Ironman 4x4 Strut Compressor

by **Branick**

Ironman 4x4 have teamed with Branick to bring you the industry leading 7600 model strut compressor. The 7600 is the top of the line strut compressor and provides a safe and efficient way to assemble and disassemble struts.

Key Features:

- *Increases workshop profitability*
- *Safer and easier than alternate methods*
- *Handles the heaviest 4WD struts*
- *Has long handles for extra torque*
- *Multi-position spring hooks*
- *Has a long compression stroke*
- *Does not require adapters*
- *Heavy duty acme thread*
- *Versatile mounting options*
- *All-steel construction*
- *Increase productivity*
- *Made in USA*



SAFER, STRONGER, SMARTER

+61 3 9532 1111
www.ironman4x4.com

FAQ / Troubleshooting

Can I assemble struts at home?

In most cases, no. Ironman 4x4 recommend strut assembly be performed only by a qualified automotive mechanic using specialised strut compressor equipment.

Assembled struts store large amounts of sprung energy. Only mechanics with necessary tools and equipment should attempt to disassemble or assemble a strut. Mishandling of strut assemblies can result in severe injury or death.

Never loosen or remove strut centre top nut until all spring energy is retained within a high quality strut compressor.

The shock absorber appears to be leaking.

Upon initial use, there may be an oily residue or a small amount of oil originating from the rod seal and surrounding parts, this is referred to as manufacturing overflow.

Oil can be trapped in the seal during assembly and released during transport or initial operation. This is considered normal and should be wiped clean prior to installation or after first use. If oil continues to appear, the shock absorber may be leaking and it should be replaced.

The shock absorber does not self-extend with gas pressure.

Ironman 4x4 Nitro Gas shock absorbers will self-extend due to pressurised nitrogen gas contained within, the rate of gas extension offers little relevance in determining the health or performance of the shock absorber.

Ironman 4x4 Foam Cell shock absorbers will NOT self-extend like a gas pressurised shock absorber as they do not contain gas pressure - A Foam Cell shock absorber will generally feel firmer to extend than it will to compress.

If a gas shock absorber fails to self-extend, this may not indicate a problem, it may simply be due to a dry or dirty piston rod, firm valving resistance or due to low gas pressure design. This does not adversely affect performance.

Avoid removing the thin film of oil from the piston rod, it is required for smooth seal operation and lubrication. A light oil may be used to rejuvenate the seal if a squeak is present.

The shock absorber appears damaged.

All Ironman 4x4 shock absorbers are twin tube construction, this means they are very resilient to damage from rocks and debris. The outer tube can tolerate dents providing no puncture exists, the shock absorber will still function as intended.

Do not allow mud or debris to accumulate for extended periods around suspension components, clean and rinse as soon as practical.

Dust shields or rubber protective boots are provided by Ironman 4x4 to protect the piston rod from rock and debris damage.

Spare parts such as bushes, boots and dust shields are often available as spare parts if required.

The lower strut bushes have perished.

This is most likely as a result of the bushes being tightened without neutralisation.

Never tighten shock absorber bushes until the vehicle is lowered to the ground.

Leave eye ring mounts finger tight ONLY, until the vehicle is lowered to the ground at normal ride height, failure to do this can damage the rubber bond due to twisting resulting in premature bush wear.

This is particularly important for load bearing lower strut bush applications.

Once the vehicle is lowered to the ground, only then tighten to specified tensions.

Can I re-use my original rubber spring bushes?

Ironman 4x4 always recommends to renew leaf spring bushes with polyurethane when new springs are fitted. The extended range of travel provided by Ironman leaf springs and longer shock absorbers can over-rotate and damage the rubber material. In all cases when a silent block press fit bush is used, it cannot be transferred to an Ironman 4x4 leaf spring.

Original two-piece rubber bushes will fit Ironman 4x4 leaf springs, however it is not recommended. When greased, polyurethane allows greater rotational freedom on the shackles pins when compared to rubber.

Does polyurethane require re-greasing?

Yes, polyurethane bushes should be re-greased as part of a regular maintenance schedule.

Ironman 4x4 recommend a Molybdenum Disulphide based grease or other grease specified for use with polyurethane.

Can I use Ironman 4x4 shock absorbers with original springs?

Yes, in all cases. (Except those specified for racing or offroad only applications such as 4" or 6" lift). Ironman 4x4 design all suspension components to be compatible with OEM suspension components.

For optimal performance, Ironman 4x4 do recommend Ironman 4x4 shock absorbers are fitted as part of an integrated suspension system comprising Ironman 4x4 springs.

Can I use Ironman 4x4 springs with original shock absorbers?

Yes, in all cases. (Except those specified for racing or offroad only applications such as 4" or 6" lift). Ironman 4x4 design all suspension components to be compatible with OEM suspension components.

For optimal performance, Ironman 4x4 do recommend Ironman 4x4 springs are fitted as part of an integrated suspension system comprising Ironman 4x4 shock absorbers.

The springs appear to be sagging.

Refer to completed installation form to measure and compare with new ride height.

Ironman 4x4 design an array of different springs to suit different load applications. It is imperative the correct spring is selected for the expected loads.

Installing a spring which is too soft for the load will result in loss of expected ride height. Installing a spring which is too strong for the load will result in excessive ride height.

To properly determine whether a spring has sagged or is under-specified, the spring must be removed from the vehicle and free height checked against the original specification found in suspension catalogue.

Depending on spring size and rate, a loss of up to 10mm due to natural steel relaxation is considered normal.

Natural settling is expected within the first 2-3 months, after which the springs are expected to maintain height.

If a spring has lost more than 10mm free height from new, they may require replacement.



FAQ / Troubleshooting

The vehicle is leaning to one side.

Refer to completed installation form to measure and compare with new ride height.

If a vehicle is leaning down on one corner, firstly ensure the vehicle is on level ground and then assess the weight distribution to ensure even placement of load and accessories.

Many vehicle models exhibit an uneven weight distribution from factory, Ironman 4x4 adjust the spring height accordingly to level the vehicle.

Check if springs are designated for Drivers Side (D/S) or Passengers Side (N/S) and ensure they are installed to the correct location.

Typically the taller coils should be fitted to the heavier side of the vehicle.

The vehicle is leaning towards front or back.

Refer to completed installation form to measure and compare with new ride height.

Typically if the vehicle is level from side to side, but down at front or back, indicates incorrect spring selection. Check springs are correctly specified to match the load and accessories.

Vehicles which feature independent suspension are generally subject to a 2:1 motion ratio, meaning that for every 1mm of movement at the spring, the ride height is affected 2mm.

This is particularly important when assessing spring settling or sag. Natural settling of 10mm at the spring will result in 20mm setting of ride height. Settling of new rubbers and bushes should also be factored as they will contribute a few additional mm.

The shock absorber feels too soft or inconsistent when compressed.

Prime the shock absorber by fully pumping it upright 2-3 times, ensuring the pressure chambers are fully purged of gas or air bubbles.

The shock absorber will generally feel firmer to extend than it will to compress.

The ride height is too high or banging over bumps.

Independent suspension operates with limited wheel travel. Ironman 4x4 design springs to increase the ride height a prescribed amount within the safe limits of the original vehicles design.

If incorrectly specified springs or additional spacers are fitted, the ride height may be excessive causing the strut to reach its upper limit "top out" during motion.

As a general rule, Ironman 4x4 recommend a MINIMUM of 60mm downward travel available in the suspension, otherwise referred to as "droop".

To establish ride height in relation to maximum height, a droop measurement will be required.

DROOP MEASUREMENT

- 1) Measure and record the vertical rim to guard distance with the vehicle on flat level ground.
- 2) Raise and support the vehicle with front or rear wheels hanging.
- 3) Measure and record the vertical rim to guard distance with the wheels fully hanging.

The difference between the two measurements is the amount of downward droop the suspension has available to it.

The minimum droop distance should be no less than 60mm fully settled.

If droop is less than 60mm, a reduction in handling performance will be experienced, possibility of damage to suspension, driveline and tyre wear can be a factor. In this case the ride height must be lowered.

There is a squeak coming from the suspension.

A squeak can originate from any number of sources or for many reasons. The most effective method to diagnose and resolve a squeak is to perform a systematic approach to locating the source. Make note of what conditions cause the squeak, ie. large bumps, small bumps, wet weather, cornering etc. Also note the type of noise whether it appears to be from a soft rubber / plastic origin or hard steel origin.

Attempt should be made to simulate the condition, such as bouncing the vehicle whilst listening to locate the source, it may be required to enlist a second person to bounce the vehicle whilst another accesses the underneath of the vehicle closely to pin point the exact location.

Typical sources for noise include:

Dry or broken bushes
Loose or misaligned components
Bent or damaged components
Steel to Steel friction
Under-tensioned bolts

The suspension appears to be rusty.

In many cases, damage to spring or shock absorber coating is unavoidable due to impacts with stones and debris. In some instances light surface rusting may appear on exposed steel if coating becomes damaged. This will not affect the performance of the product however may be unsightly. Take care when using a high pressure washer or strong chemicals during cleaning as this can further compromise the coating leading to greater exposure.

Care should be taken during installation to ensure components are not scratched or damaged which may result in exposure of the underlying steel.

Vehicles operating in salty environments may experience further accelerated surface rusting.

There is a vibration after fitting the suspension.

This is a known issue in some vehicles after ride height has been raised. It is caused by the change in angle within the driveline, most commonly in vehicles with 2 piece driveshafts.

In many cases where vibration is a common factor, Ironman 4x4 offer a solution such as a driveline spacer kit to adjust the angles of the driveshaft. The spacer kits are used to adjust the location of the centre bearing with view to reduce the vibration to a satisfactory level.

Each vehicle can vary in severity, some may not be fully rectified after the re-alignment. In such cases axle wedges or a reduction in ride height may be required.

Can I adjust the strut seat height?

Ironman 4x4 struts feature an adjustable height spring seat. 12xxx & 24xxx series struts utilise a trim packer system, 45xxx series struts utilise a threaded strut body.

Seat height cannot be adjusted whilst in vehicle, strut must be removed from vehicle with spring tension unloaded to enable adjustment.

The purpose of this adjustment feature is to allow recalibration of ride height following the installation of heavy accessories or to compensate spring settling.

Not to be used as a variable ride height system.

An increase in seat height beyond OEM specifications may result in excessive lift and non-compliance to state or federal laws.

A minimum 60mm suspension droop must be available at all times.

Accessories Selection and Information

Effective 1 December 2022



Features and Benefits

COMMERCIAL BULL BAR



Australian Designed and Engineered.

Styled around the contours of the vehicle.

Tested in Australia and complies to ADRs and airbag compatibility.

Designed to ensure maximum strength, protection and improved approach angle.

Winch compatible on separate winch cradle removing excess weight off the bar and reducing weight on the front suspension.

An improved level of occupant safety from animal strikes.

Made using the highest quality SPHC oil and pickled steel.

Robot welded together for ultimate strength and accuracy.

Bar comprises of the following features

A-Frame 50mm triple loop design, integrated LED parker and indicator, high lift jack points, aerial tab. Driving light mounting locations. Reinforced front centre and side wing for protection.

The Ironman 4x4 commercial bar is perfect for the customer who wants maximum protection without the option of fog lights. Perfect for the avid 4wder, daily driver or fleet buyer.

COMMERCIAL DELUXE BULL BAR



Australian Designed and Engineered.

Styled around the contours of the vehicle.

Tested in Australia and complies to ADRs and airbag compatibility

Designed to ensure maximum strength, protection and improved approach angle.

Winch compatible on separate winch cradle removing excess weight off the bar and reducing weight on the front suspension.

An improved level of occupant safety from animal strikes.

Made using the highest quality SPHC oil and pickled steel.

Robot welded together for ultimate strength and accuracy.

Bar comprises of the following features

A-Frame 50mm triple loop design, integrated LED parker and indicator, fog light and loom, high lift jack points, aerial tab. Driving light mounting locations. Reinforced front centre and side wing for protection.

The Ironman 4x4 commercial deluxe bar is perfect for the customer who wants maximum protection with the option of a fog lights. Perfect for owner wanting a more styled protective option whilst maintaining or adding fog lights.

PROTECTOR BULL BAR



Australian Designed and Engineered.

Styled around the contours of the vehicle.

Tested in Australia and complies to ADRs and airbag compatibility.

Designed to ensure maximum strength, protection and improved approach angle.

Winch compatible on separate winch cradle removing excess weight off the bar and reducing weight on the front suspension.

An improved level of occupant safety from animal strikes.

Made using the highest quality SPHC oil and pickled steel.

Robot welded together for ultimate strength and accuracy.

Bolt on 304 stainless steel loops.

Bar comprises of the following features

Bolt on triple loops 75mm centre and 50mm outer loops, integrated LED parker and indicator, fog light and loom, high lift jack points, aerial tab. Driving light mounting locations. Reinforced front centre and side wing for protection.

The Ironman 4x4 protector bar is perfect for the customer who wants maximum protection with the option of a fog lights and with the shine of stainless steel loops. Perfect for owner wanting a to match the chrome highlights on their vehicle whilst maintaining protection.

PROGUARD NO LOOP BULL BAR



Australian Designed and Engineered.

Styled around the contours of the vehicle.

Tested in Australia and complies to ADRs and airbag compatibility

Designed to ensure maximum strength, protection and improved approach angle.

Winch compatible on separate winch cradle removing excess weight off the bar and reducing weight on the front suspension.

An improved level of occupant safety from animal strikes.

Made using the highest quality SPHC oil and pickled steel.

Robot welded together for ultimate strength and accuracy.

Features no loops for a bumper replacement look.

Bar comprises of the following features

Lower bull bar section only, integrated LED parker and indicator, fog light and loom, high lift jack points, Driving light mounting locations. Reinforced front centre and side wing for protection.

The Ironman 4x4 proguard bar is perfect for the customer who wants some protection with the option of a fog lights but without the addition of full loops. Single or triple stainless-steel loops can be added for increased protection. Perfect for owner wanting a look of a bumper replacement bar but with the option to add to the bar with different loops.

Features and Benefits

PREMIUM COMMERCIAL DELUXE BULL BAR



Australian Designed and Engineered.

Styled around the contours of the vehicle.

Tested in Australia and complies to ADRs and airbag compatibility.

Designed to ensure maximum strength, protection and improved approach angle.

Winch compatible on separate winch cradle removing excess weight off the bar and reducing weight on the front suspension.

An improved level of occupant safety from animal strikes.

Made using the highest quality SPHC oil and pickled steel.

Robot welded together for ultimate strength and accuracy.

Designed for the larger 4wds.

Bar comprises of the following features

A-Frame 60mm triple loop design, integrated LED parker and indicator, metal fog light surround with fog lights and loom, high lift jack points, 3 aerial tabs. Driving light mounting locations. Reinforced front centre and side wing for protection.

The Ironman 4x4 Premium deluxe bar is perfect for the customer who wants maximum protection with the option of a fog lights. Perfect for owner of a larger 4wd wanting a more protection coverage and a larger tube size.

POLISHED ALLOY BULL BAR



Australian Designed and Engineered.

35% less weight than steel bull bar.

Styled around the contours of the vehicle.

Tested in Australia and complies to ADRs and airbag compatibility

Designed to ensure maximum strength, protection and improved approach angle.

Winch compatible on separate winch cradle removing excess weight off the bar and reducing weight on the front suspension.

An improved level of occupant safety from animal strikes.

Made using the highest quality 5052 Aluminium.

Welded together for ultimate strength and accuracy.

Bar comprises of the following features

Triple loops 75mm centre and 50mm outer loops, integrated LED parker and indicator, fog lights and loom, 2 aerial tabs. Driving light mounting locations. Reinforced front centre and side wing for protection.

The Ironman 4x4 Polished alloy bar is perfect for the customer who wants maximum protection with advantage of less weight. The Polished alloy bar weighs 35% less when compared to steel bars.

PROGUARD SINGLE OR TRIPLE LOOP



Add to the Proguard no loop bull bar for increased protection, style and for aesthetics.

75mm 304 stainless steel tubing centre loop can be added for added styling to complement any vehicle and increase protection in the centre of the vehicle.

The triple loop design is made up of 75mm centre loops with 50mm outer loops out of 304 stainless steel. The triple loops can be added for added styling to complement any vehicle and increase protection across the full front of the vehicle.

Includes

Centre loop bar and overriders.

RECOVERY POINTS



A rated recovery point is an essential accessory for any 4wd. Designed in Australia tested and approved to ensure the safest connection point on the vehicle for a recovery.

Designed using 12mm steel with elongated hole to allow a rated shackle or soft shackle to pass through, allowing the strap to be on the correct angle.

Powder coated Red for quick and easy identification with safety instructions on each point. Rated at 5000kgs, the rated recovery points can be used with an equalisation strap allowing load distribution across both points.

SIDE STEPS



Side steps provide a stronger step option that bolt to the chassis and not the body. The steel steps Allows for easy access to vehicle.

Premium Steel Construction - Made from the highest quality SPHC oil and pickled steel for maximum strength and resistance to rust.

Heavy duty black powder coated checkerplate tread is not only stylish, but practical and durable.

Newer Hybrid Design - Allows for the addition of side rails at a later point

Can be colour coded to match vehicle paint colour.

SIDE RAILS



Designed to be added to the Ironman 4x4 side step range for complete sill, door and panel protection.

Premium Steel Construction - Made from the highest quality SPHC oil and pickled steel for maximum strength and resistance to rust.

Heavy duty black powder coating is practical and durable, or can be colour coded to match vehicle paint colour. Easily attach to Ironman 4x4 hybrid side steps and most bull bars on the market.

Features and Benefits

SNORKELS

Snorkels provide cleaner, dryer and cooler air to the vehicles engine. By raising the height of the vehicles air intake, this also allows for safer water crossings. The ram head forces air into the airbox and deflects any rain, forcing the rain to the outer edges, allowing the rain to exit at the head level and not enter the airbox.



Heavy Duty Construction - Made from the highest quality LLPDE and has the highest UV rating for harsh outback environments.

3D Scanned and Designed - Ensures the snorkel complements the contour lines of your vehicle.

CANVAS SEAT COVERS

Tailored - Comfort canvas seat covers to suit most off-road vehicles



Highest quality manufacturing - Made from 12oz, 100% cotton natural fibre canvas that is water, mud and fire resistant

Cushioning Foam - Adds an extra level of - Comfort with the added extra layer of cushioning foam whilst providing an air gap to keep cooler

100% Airbag Deploy Safe - Employs the use of a special thread and controlled stitching process to ensure compliance.

Built-in - Map pockets and lumbar support control access.

WINCHES

Australian engineer, designed and tested.

Designed to suit all Ironman 4x4 Bull Bars as well as most winch compatible bull bars on the market.

9,500lb or 12,000lb options, available with synthetic rope or steel cable.

High speed balanced motor with sealed bearings and fully sealed style solenoid. Repositionable clutch handle. IP68 rated with external remote breather. Integrated anti-tamper power cut off and an all in one wireless/plug in controller with LED torch.



LED LIGHTS

Available in a range of Driving Light or Light Bar styles to suit most end user requirements.

See page 23-26 for different styles, or page 434-435 for technical specifications and product comparison.



DC TO DC BATTERY CHARGERS

Made in Australia, the 40 amp DC to DC charger is suitable for 12 volt vehicle and trailer systems. The DC to DC unit also works with standard or variable/smart alternators. 3-stage 12V booster charger. Remote charge status LED indicator. Very low standby current <3mA.



Optional start assist kit, assists to start the car when the main battery is flat and also can boost charge amperage output to 80Amp max.

ELECTRIC BRAKE CONTROLLER

Easily adjust the strength of the brakes on your trailer when towing.

Easy adjustment dashboard dial. Remote hideaway control box. Mountable at any angle. Push button override function. Dual axle capability.

Compatible with ESC, single and dual axle trailers

Alko Approved unit.



REAR TOW BARS

Australian Designed and developed to suit 4x4 vehicles with factory bumpers.

Dynamic and static testing to 3500kg. Comes complete with tow hitch, pin and 3500kg rated 50mm tow ball.



REAR PROTECTION TOW BARS

Designed for complete vehicle rear protection.

Meets ADR and Australian towing standards. Side rear quarter protection. 4mm steel construction with 8mm tow bar sub frame. Protected location for anderson and trailer plug. LED numberplate lights. Dynamic and static testing to 3500kg. Comes complete with tow hitch, pin and 3500kg rated 50mm tow ball.



ABS CANOPIES

Heavy duty 9mm smooth finish ABS Plastic construction with an in-built metal supporting frame.

Marine carpet lined. Colour coded options or can be matched to suit vehicle colour. Rear LED stop light on some models. Plug and play wiring loom. Internal clamps. Internal light and front sliding window. Lockable tinted lift up windows with gas struts. Central locking available for some models.



Features and Benefits

PINNACLE CANOPIES

Heavy duty smooth finish vinyl ester fiberglass construction with a reinforced structural frame.



Colour coded options or can be matched to suit vehicle colour. Roof rails. Internal battery operated light. Internal front sliding window. Lockable tinted lift up windows with gas struts. Central locking.

SINGLE AND TWIN DRAWER SYSTEMS

Available as a single or double drawer option. Wing kits available to suit twin drawer systems.



Comes fully assembled. 100kg rating per drawer. Galvanised steel construction lined with marine grade carpet. T-Lock lockable handles.

LONG RANGE FUEL TANKS

Designs to suit a wide range of models, with capacities of up to 160L.



2mm aluminised steel with a black powdercoat finish. 5 day pressure tested. Internal baffles.

ICE CUBE FRIDGE / FREEZERS

SECOP Compressor. Electronically controlled. Low energy consumption. 3 year components warranty. 5 year compressor warranty. Fridge or freezer functionality (65L has both).



ROOFTOP TENTS

Soft Rooftop Tent

Premium 280gsm Ripstop poly cotton canvas. Insect mesh, internal covers and heavy duty 1000D waterproof cover.



Add on Annex options are available for this model (sold separately).

Swift 1400 Rooftop Tent

Premium 280gsm Ripstop poly cotton canvas. Insect mesh, internal covers, 80mm high density foam mattress, roof rails and all enclosed in a heavy duty aluminium hard top and base.

Nomad 1300 Rooftop Tent

Premium 280gsm Ripstop poly cotton canvas and 420D Oxford flysheet. Insect mesh, 80mm high density foam mattress and all enclosed in a heavy duty ABS top and base.

Front extension awning kit are available for this model (sold separately).

AWNINGS

Available in a range of widths and lengths and styles. Please see page 24-26 for details and other add on options that are also available.



Premium 280gsm Ripstop UV50+ rated poly cotton canvas. Twist lock aluminium poles. Reflective guy ropes. 1000D PVC cover. Room enclosures available as an add on.

STEEL ROOF RACKS

Available in a range of styles and sizes, please see page 38 for variations.



Strong steel construction.

Spare wheel mount on Cage and Trade style racks.

Durable black powdercoated finish. Heavy duty reinforced mesh flooring. Wind noise reducing air deflector plate.

Roof rack mounting kits also available, sold separately.

ALLOY ROOF RACKS

Available in a range of styles and sizes, please see page 37 for variations.



Up to 60% lighter than steel roof racks.

Lightweight but strong alloy construction.

Durable gunmetal grey powdercoated finish. Heavy duty reinforced aluminium mesh flooring. Wind noise reducing air deflector plate.

Roof rack mounting kits also available, sold separately.

UNDERBODY PROTECTION

Safeguard against off-road damage from rocks, stumps and ground strikes. Available in IUP or UBP series.



See vehicle listings to see options available for each vehicle.

IUP Series

2.5-3mm pressed and folded steel.

Easy bolt-on installation.

Semi-gloss black powdercoated finish.

UBP Series

4mm fabricated steel.

Recessed hardware and integrated framework.

5 x impact resistance.

Airflow ventilation channels and service inspection holes.

Textured black powdercoated finish and anti-corrosion coating.



Accessories Specifications

Effective 1 December 2022



Winches and Bull Bars

MONSTER WINCHES

| Part Number | Capacity | Description | Weight |
|-------------|----------|---|-----------------|
| WWB9500 | 9500lb | With Steel Cable and Wireless Plug in Controller | N.W 42kg (90lb) |
| WWB12000 | 12000lb | With Steel Cable and Wireless Plug in Controller | N.W 44kg (98lb) |
| WWB9500SR | 9500lb | With Synthetic Rope and Wireless Plug in Controller | N.W 28kg (62lb) |
| WWB12000SR | 12000lb | With Synthetic Rope and Wireless Plug in Controller | N.W 29kg (64lb) |

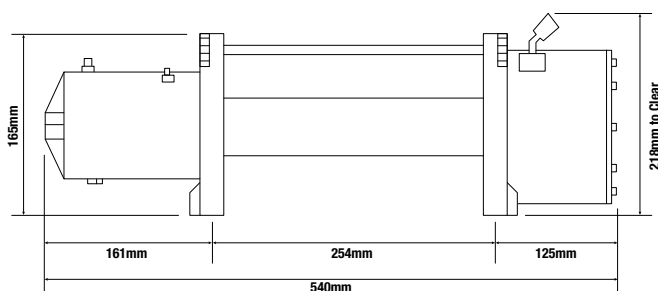

SIDE VIEW

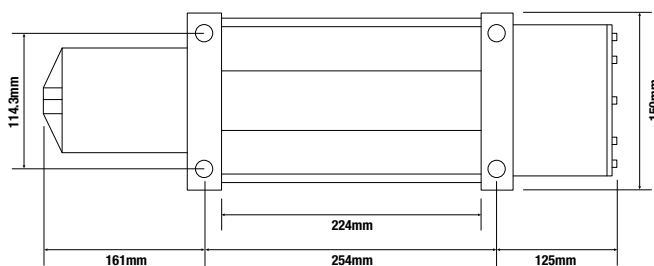

BOLTING PATTERN

BULL BARS

IMPORTANT: IRONMAN 4X4 BULL BARS CONFORM TO AUSTRALIAN STANDARDS AS47861.1/2002

- Scanned in 3D to ensure a correct and accurate fit with a stylish, but dependable design
- Ironman 4x4 bull bars are tested for ADR, Airbag compliance and compatibility with vehicle safety systems
- Made from the highest quality of SPHC oil and pickled steel (not mild steel) for maximum strength and highest resistance to rust
- Ironman 4x4 bull bars are CNC laser cut, bent and robot welded for optimum accuracy and finish
- Ironman 4x4 designed and engineered to ensure Airbag compatibility
- Winch compatible and use a unique mounting cradle to remove excess weight from the bull bar
- Black powdercoating using AKZO NOBEL powder (YN100G) allows a thicker, smoother and more durable coating
- Ironman 4x4 designed aerial mount for quick installation and removal of an aerial
- Integrated spot light or light bar mounts



360° ROBOT WELDS



FOG LIGHTS



LED PARKER / INDICATOR LIGHTS



SPOT OR LIGHT BAR MOUNTS



AERIAL MOUNT

COMMERCIAL

- ADR 69, 73 compliant
- Air bag tested and certified
- Winch compatible
- Aerial mount

BBC

- Steel construction
- A-Frame triple loop design
- Tough polyurethane bumpers
- LED parker / indicator included



Bull Bars

COMMERCIAL DELUXE

BBCD

- ADR 69, 73 compliant
- Air bag tested and certified
- Winch compatible
- Aerial mount
- Steel construction
- A-Frame triple loop design
- Tough polyurethane bumpers
- Fog lights (55W H3)
- LED parker / indicator included



PROTECTOR

BBT

- ADR 69, 73 compliant
- Air bag tested and certified
- Winch compatible
- Aerial mount
- Steel construction
- Stainless steel triple loop design
- Tough polyurethane bumpers
- Fog lights (55W H3)
- LED parker / indicator included



POLISHED ALLOY

BBA

- ADR 69, 73 compliant
- Air bag tested and certified
- Winch compatible
- Aerial mount
- 5mm aluminium frame
- 5mm sub frame
- 35% lighter than steel
- A-Frame triple loop design
- Tough polyurethane bumpers
- LED parker / indicator included



PREMIUM COMMERCIAL DELUXE

BBP

- ADR 69, 73 compliant
- Air bag tested and certified
- 60.3mm steel tube construction
- Winch compatible
- Aerial mount
- A-Frame triple loop design
- Tough polyurethane bumpers
- Fog lights (55W H3)
- LED parker / indicator included



PROGUARD NO LOOP

BBT

- ADR 69, 73 compliant
- Air bag tested and certified
- Winch compatible
- Steel construction
- Tough polyurethane bumpers
- Fog lights (55W H3)
- LED parker / indicator included
- Single or triple loop options available



RAID SERIES

BBR

- ADR 69, 73 compliant
- Air bag tested and certified
- Winch compatible
- Steel construction
- Integrated recovery points
- Cube lights and lightbars shown are available as additional options



Panel Protection and Recovery

Bull Bars, Rear Tow Bars, Side Steps / Rails and Recovery Points

| TO SUIT VEHICLE MAKE AND MODEL | Commercial | Commercial Deluxe | Protector | Polished Alloy | Proguard No Loop ³ | Premium / Special | Recovery Points | Tow Bars | Rear Step Bars | Side Steps and Rails | Side Steps | Side Rails | Page |
|---|-------------------------------------|-------------------|--------------|--|-------------------------------|-------------------|-------------------|-----------|----------------|----------------------|-------------------|--------------------------|------|
| | 86kg 51mm | 86 kg 51mm | 82kg 51mm | 62kg 51mm | 75kg - | 92kg 60.3mm | - - | 30kg - | 69kg - | 53kg 51/60.3mm | 40kg 51/60.3mm | 13kg 51/60.3mm | |
| To Suit Fiat Fullback 2016+ | BBC050 | BBCD050 | | BBA050 | BBT050-NL | | IRP050 | TB050 | RTB050 | SSR050 | SS050 | SS050 RAIL | 45 |
| To Suit Ford Maverick 1988-1994 (See Nissan GQ Patrol) | | BBCD010 | | | | | | | | | | | 228 |
| To Suit Ford Ranger Raptor 2018+ | | | | | | | | | RTB069 | | | | 49 |
| To Suit Ford Ranger Next-Gen 2022+ | BBC110 | BBCD110 | | | | BBR110 | Integrated in Bar | TB110 | RTB110 RBP110 | SSR110 | SS110 | SS110 RAIL | 50 |
| To Suit Ford Ranger PX Mk III 8/2018+ WITH or WITHOUT Tech Pack Adaptive Cruise Control (CC) | | BBCD066* | | | BBT066-NL* | | IRP054 | TB066 | RTB066 | SSR054 | SS054 | SS054 RAIL | 52 |
| To Suit Ford Ranger PX Mk III 8/2018+ WITHOUT Tech Pack Adaptive CC With Sensor Provisions | BBC055 | BBCD055 | | | | | IRP054 | TB066 | RTB066 | SSR054 | SS054 | SS054 RAIL | 52 |
| To Suit Ford Ranger PX Mk II 2015-7/2018 WITH or WITHOUT Tech Pack Adaptive Cruise Control (CC) | BBC055 | BBCD054 | | | BBT054-NL | | IRP054 | TB066 | RTB066 | SSR054 | SS054 | SS054 RAIL | 56 |
| To Suit Ford Ranger PX Mk II 2015-7/2018 WITHOUT Tech Pack Adaptive CC With Sensor Provisions | BBC055 | BBCD055 | | | | | IRP054 | TB066 | RTB066 | SSR054 | SS054 | SS054 RAIL | 56 |
| To Suit Ford Ranger PX 9/2011-2015 | BBC038 | BBCD038 | | | BBT038-NL | | IRP054 | TB066 | RTB066 | SSR054 | SS054 | SS054 RAIL | 60 |
| To Suit Ford Ranger PJ / PK 2007+ ² | | BBCD014 | BBT014 | | | | | | | SSR002 | SS008 | | 64 |
| To Suit Ford Everest AU II 7/2018+ WITH or WITHOUT Tech Pack Adaptive Cruise Control (CC) | | BBCD066* | | | BBT066-NL* | | IRP054 | | | SSR055 | SS055 | SS055 RAIL | 67 |
| To Suit Ford Everest AU II 7/2018+ WITHOUT Tech Pack Adaptive CC With Sensor Provisions | BBC055 | BBCD055 | | | | | IRP054 | | | SSR055 | SS055 | SS055 RAIL | 67 |
| To Suit Ford Everest 2015-6/2018 WITH or WITHOUT Tech Pack Adaptive Cruise Control (CC) | | BBCD054 | | | BBT054-NL | | IRP054 | | | SSR055 | SS055 | SS055 RAIL | 69 |
| To Suit Ford Everest 2015-6/2018 WITHOUT Tech Pack Adaptive CC With Sensor Provisions | BBC055 | BBCD055 | | | | | IRP054 | | | SSR055 | SS055 | SS055 RAIL | 69 |
| To Suit GM/Chevrolet Silverado 1500 2019+ | BBR087E - (Raid Full Length Bumper) | | | | | | | | | | SS087 | | 71 |
| To Suit GM/Holden Trailblazer LT / LTZ 11/2017+ | BBC057 | BBCD057 | | | BBT057-NL | | IRP057 IRP058 | | | SSR044 | SS044 | SS044 RAIL | 76 |
| To Suit GM/Holden Colorado RG 11/2016-2020 | BBC057 | BBCD057 | | | BBT057-NL | | IRP057 IRP058 | TB040 | RTB040 | SSR057 | SS057 | SS057 RAIL | 80 |
| To Suit GM/Holden Colorado RG 2012-10/2016 | BBC040 | BBCD040 | | | | | IRP058 | TB040 | RTB040 | SSR057 | SS057 | SS057 RAIL | 83 |
| To Suit GM/Holden Colorado 7 RG 2012+ | | BBCD044 | | | | | IRP058 | | | SSR044 | SS044 | SS044 RAIL | 78 |
| To Suit GM/Holden Colorado RC 7/2008-12/2012 ^{1,2} | | BBCD027 | BBT027 | | | | | | | SSR006 | SS001 | | 87 |
| To Suit GM/Holden Rodeo RA7 2007-7/2008 | | BBCD020 | | | | | | | | SSR006 | SS001 | | 89 |
| To Suit GM/Holden Rodeo RA 2002-2006 ² | | BBCD003 | | | | | | | | SSR006 | SS001 | | 91 |
| To Suit Great Wall Ute Cannon 9/2020+ | | BBCD083 | | | | | | | RTB083 | SSR083 | SS083 | SS083 RAIL | 94 |
| To Suit Isuzu D-MAX 8/2019+ | BBC074 | BBCD074 | | | BBT074-NL | | IRP074 | | RTB074 | SSR074 | SS074 | SS074 RAIL | 98 |
| To Suit Isuzu D-MAX 2/2017-7/2019 (Will not fit narrow body) | BBC058 | BBCD058 | | | BBT058-NL | | IRP058 | TB041 | RTB041 | SSR057 | SS057 | SS057 RAIL | 101 |
| To Suit Isuzu D-MAX 6/2012-1/2017 | BBC041 | BBCD041 | | | | | IRP058 | TB041 | RTB041 | SSR057 | SS057 | SS057 RAIL | 104 |
| To Suit Isuzu D-MAX 2007-6/2012 ² | | BBCD020 | | | | | | | | SSR006 | SS001 | | 108 |
| To Suit Isuzu MU-X 8/2021+ | | BBCD096 | | | BBT095-NL | | IRP074 | | | SSR095 | SS095 | SS095 RAIL | 110 |
| To Suit Isuzu MU-X 3/2017-7/2021 | | BBCD061 | | | BBT061-NL | | IRP058 | | | SSR044 | SS044 | SS044 RAIL | 110 |
| To Suit Isuzu MU-X 2014-2/2017 | | BBCD049 | BBT049 | | | | IRP058 | | | SSR044 | SS044 | SS044 RAIL | 110 |
| To Suit Jeep Gladiator JT 4/2019+ | BBR077 - (Raid Full Length Bumper) | | | BBR077ST ⁴ - (Raid Stubby Bumper) | | | | | RTB077JT | | SS077JT | | 118 |
| To Suit Jeep Grand Cherokee WK2 2013+ ⁵ | | BBCD052 | | | | | | | | | | | 120 |
| To Suit Jeep Wrangler JL (4 Door) 2018+ | BBR077 - (Raid Full Length Bumper) | | | BBR077ST ⁴ - (Raid Stubby Bumper) | | | | TB077JL | RTB077JL | | SS077JL | | 124 |
| To Suit Jeep Wrangler JK 2007+ | | BBCD035 | | | | | | | | | | | 126 |
| To Suit LDV T60 2017+ | | BBCD068* | | | BBT068-NL* | | | | | | | | 142 |
| To Suit Mazda BT50 6/2020+ | BBC080 | BBCD080 | | | BBT080-NL | | IRP080 | | RTB080 | SSR074 | SS074 | | 147 |
| To Suit Mazda BT50 2012-5/2020 ² | BBC039 | BBCD039 | | | BBT039-NL | | IRP054 | TB066 | RTB066 | SSR039 | | | 150 |
| To Suit Mazda BT50 J97M 2006-2011 ^{1,2} | | BBCD024 | BBT024 | | | | | | | SSR007 | SS009 | | 154 |
| To Suit Mitsubishi Pajero Sport 7/2019+ | | BBCD079* | | | BBT079-NL* | | IRP059 | | | | SS079 | | 162 |
| To Suit Mitsubishi Pajero Sport 11/2016-6/2019 (BBCD suits GLX +GLS only) | | BBCD059* | | | BBT059-NL* | | IRP059 | | | | SS059 | | 164 |
| To Suit Mitsubishi Pajero NW 2011-NX | | BBCD045 | | | | | | | | | | | 166 |
| To Suit Mitsubishi Pajero NS & NT 5/2000-2011 | | BBCD045 | | | | | | | | | | | 167 |
| To Suit Mitsubishi Triton MR (GLS Model) 11/2018+ | BBC067* | BBCD067* | | | BBT067-NL* | | IRP059 | TB050 | RTB067GLS | SSR050 | SS050 | SS050 RAIL | 178 |
| To Suit Mitsubishi Triton MR (Non-GLS Model) 11/2018+ | BBC067* | BBCD067* | | | BBT067-NL* | | IRP059 | TB050 | RTB067GLX | SSR050 | SS050 | SS050 RAIL | 178 |
| To Suit Mitsubishi Triton MQ 2015-10/2018 | BBC050 | BBCD050 | | BBA050 | BBT050-NL | | IRP050 | TB050 | RTB050 | SSR050 | SS050 | SS050 RAIL | 182 |
| To Suit Mitsubishi Triton MN 2009-2015 ^{1,2} | BBC031 | BBCD031 | | | | | | | | SSR031 | SS031 | | 187 |
| To Suit Mitsubishi Triton ML 2006-2009 ^{1,2} | | BBCD016 | BBT016 | | | | | | | SSR031 | | | 190 |
| To Suit Nissan Navara NP300 2021+ (Series 5) | | BBCD082 | | | BBT082-NL | BBP082 | IRP005 | | RTB082 | SSR048-D / SSRP082 | SS048-D / SSP082 | SS082 RAIL / SSP082 RAIL | 197 |
| To Suit Nissan Navara NP300 2015-2020 (Series 1-4) | BBC048 | BBCD048 | | BBA048 | BBT048-NL | | IRP005 | TB048 | RTB048 | SSR048 | SS048 | SS048 RAIL | 200 |
| To Suit Nissan Navara D40 ² (Does not suit 2010+ STX - Spain Build) | | BBCD012 | | | | | IRP005 | | | SSR003 | SS007 | | 203 |
| To Suit Nissan Navara D40 V6 2010+ STX ² | | BBCD042 | | | | | IRP005 | | | SSR042 | SS042 | | 203 |
| To Suit Nissan Navara D22 2002+ ^{1,2} | | BBCD013 | | | | | | | | | | | 206 |



Panel Protection and Recovery

| TO SUIT VEHICLE MAKE AND MODEL | Commercial | Commercial Deluxe | Protector | Polished Alloy | Proguard No Loop ³ | Premium / Special | Recovery Points | Tow Bars | Rear Step Bars | Side Steps and Rails | Side Steps | Side Rails | Page |
|---|--|----------------------|-------------------------|----------------|-------------------------------|-------------------|-----------------|----------|------------------------|----------------------|--------------------|------------------------------|----------|
| | 86kg 51mm | 86 kg 51mm | 82kg 51mm | 62kg 51mm | 75kg - | 92kg 60.3mm | | - - | 30kg - | 69kg - | 53kg 51/60.3mm | 40kg 51/60.3mm | |
| To Suit Nissan Pathfinder R51 2005-2013 | | BBCD012 | | | | | | | | | | | 210 |
| To Suit Nissan Pathfinder R51 2010+ (Spain Built) | | BBCD042 | | | | | | | | | | | 210 |
| To Suit Nissan Patrol Y62 2020+ | | | | | | BBP084 | | | | SSR0084 | SSP084 | SSP084 RAIL | 216 |
| To Suit Nissan Patrol Y62 2010-2019 | | | | | | BBP062 | | | | | | | 216 |
| To Suit Nissan Patrol Y61 GU Series 4 2005+ ¹ | | | | | | BBP011 | IRP005 | | | SSR012 / SSRP011 | SS012 | | 218 |
| To Suit Nissan Patrol Y61 GU Series 1-3 1998-2004 ¹ (Coil Spring Only) | | BBCD009 | | | | | IRP005 | | | SSR012 | SS012 | | 219 |
| To Suit Nissan Patrol Y60 GQ 1987-1997 ¹ (Coil Spring Only) | | BBCD010 | | | | | | | | | | | 228 |
| To Suit Ram 1500 DT 6/2018+ | BBR085E - (Raid Full Length Bumper) | | | | | | | | RTB085 (US) / RTB085AU | | SS085 | | 238 |
| To Suit Ram 1500 DS 2014+ | BBR075E - (Raid Full Length Bumper) | | | | | | | | RTB075 (US) / RTB075AU | | SS075 | | 239 |
| To Suit Renault Alaskan 2017+ (Thai Built Only) | BBC048 | BBCD048 | | BBA048 | BBT048-NL | | | TB048 | RTB048 | SSR048 | SS048 | SS048 RAIL | 241 |
| To Suit SsangYong Musso Q200 / 201 / 205 / 215 10/2018+ | | BBCC071* | | | | | | | | | | | 243 |
| To Suit SsangYong Rexton Y400 10/2018+ | | BBCC071* | | | | | | | | | | | 248 |
| To Suit Suzuki Jimmy GJ 2019+ | | BBCC070* | | | | BBS070* | IRP070 | | | | | | 254 |
| To Suit Suzuki Jimmy 2012-2018 | | BBCC063* | | | | | | | | | | | 256 |
| To Suit Suzuki Grand Vitara 2012+ ⁶ (Diesel Manual Only) | | BBCD046 | BBT046 | | | | | | | | | | 260 |
| To Suit Toyota 4Runner Gen 5 N280 2009+ | BBR078 ⁴ - (Raid Stubby Bumper) | | | | | | | | RTB078 | | SS078 | | 264 |
| To Suit Toyota FJ Cruiser 2006+ | | BBCD037 | | | | | | | | | | | 270 |
| To Suit Toyota Fortuner 2020+ (facelift) | | BBCD081 | | | BBT081-NL | | IRP051 | | | SSR053 | SS053 | SS053 RAIL | 272 |
| To Suit Toyota Fortuner 2015-9/2020 | | BBCD053 | BBT053 | | BBT053-NL | | IRP051 | | | SSR053 | SS053 | SS053 RAIL | 272 |
| To Suit Toyota Hilux 8/2020+ | BBC065-NB ⁹ | BBCC076 | BBCC076-NB ⁹ | | BBT076-NL | | IRP051 | TB051 | RTB051-SPR | SSR051 | SS051 | SS051 RAIL | 278 |
| To Suit Toyota Hilux Revo 5/2018-7/2020 | BBC065 | BBCD065 | | BBA065 | BBT065-NL | | IRP051 | TB051 | RTB051-SP | SSR051 | SS051 | SS051 RAIL | 282 |
| To Suit Toyota Hilux Revo 2015-4/2018 | BBC051 | BBCD051 | | BBA051 | BBT051-NL | | IRP051 | TB051 | RTB051-SP | SSR051 | SS051 | SS051 RAIL | 282 |
| To Suit Toyota Hilux Vigo 10/2011-2015 ¹ | BBC033 | BBCD033 | BBT033 | | | | IRP033 | | | SSR033 | SS033 | | 286 |
| To Suit Toyota Hilux Vigo 3/2005-9/2011 ¹ | BBC002 | BBCD002 | | | | | IRP033 | | | SSR033 | SS033 | | 286 |
| To Suit Toyota Hilux Tiger 1997-2004 IFS ¹ | | BBCD001 | | | | | | | | | | | 290 |
| To Suit Toyota Landcruiser 300 Series 2022+ | BBR090 /P - (Raid Full Length Bumper) | | | | | BBP090 | IRP090 | | | SSRP090 | SSP090 | | 294 |
| To Suit Toyota Landcruiser 200 Series 11/2015+ | | | | BBA056-VX* | BBT-056VX-NL* | BBP056-VX* | IRP056 | | | SSRP056 | SSP056 | SSP056 RAIL | 296 |
| To Suit Toyota Landcruiser 200 Series / Lexus LX 570 2/2012-10/2015 | | | | | | BBP043 | IRP056 | | | | | | 298 |
| To Suit Toyota Landcruiser 200 Series / Lexus LX570 11/2007-1/2012 | | | | | | BBP025 | IRP056 | | | | | | 298 |
| To Suit Toyota Landcruiser 105 Series 3/1998-10/2007 | | BBCD005 | | | | | IRP005 | | | | | | 300 |
| To Suit Toyota Landcruiser 100 Series IFS / Lexus LX470 3/1998-10/2007 | | BBCD006 | | | | | IRP005 | | | | | | 303 |
| To Suit Toyota Landcruiser 80 Series / Lexus LX 450 1990-1998 | | BBCD004 | | | | | IRP005 | | | | | | 305 |
| To Suit Toyota Landcruiser 79 Series Single Cab 9/2016+ ¹ | BBC019SC | | | | | BBP019SC | IRP019SC | | | SSR019SC / SSRP019SC | SS019SC / SSP019SC | SS019SC RAIL / SSP019SC RAIL | 308 |
| To Suit Toyota Landcruiser 79 Series Single Cab 2007-8/2016 ¹ | BBC019E | | | | | BBP019E | IRP019 | | | SSR016 / SSRP016 | SS016 | SSR016 | 308 |
| To Suit Toyota Landcruiser 79 Series Single Cab 1999-2007 ¹ | | BBCD018 | | | | | | | | | | | 308 |
| To Suit Toyota Landcruiser 79 Series Dual Cab 11/2012+ ¹ | BBC019E | | | | | BBP019E | IRP019 | | | SSR019 / SSRP019 | SS019 | | 311 |
| To Suit Toyota Landcruiser 78 Series Troop Carrier 2007+ ¹ | BBC019E | | | | | BBP019E | IRP019 | | | | | | 315 |
| To Suit Toyota Landcruiser 78 Series Troop Carrier 1999-2007+ ¹ | | BBCD018 | | | | | | | | | | | 319 |
| To Suit Toyota Landcruiser 76 Series 2007+ ¹ | BBC019E | | | | | BBP019E | IRP019 | | | SSR015 / SSRP015 | SS015 | | 323 |
| To Suit Toyota Landcruiser 75, 78, 79 Series 1984-2007 | | BBCD018 | | | | | | | | | | | 308, 326 |
| To Suit Toyota Prado 150 Series Facelift 11/2017+ | | | | | BBT064-NL* | BBP064* | IRP064 | | | SSRP064 | SSP064 | SSP064 RAIL | 340 |
| To Suit Toyota Prado 150 Series 10/2013-10/2017 | BBC047 | BBCD047 | | | | | IRP064 | | | SSR047 | SS047 | | 343 |
| To Suit Toyota Prado 150 Series 11/2009-10/2013 | | BBCC029 ⁸ | | | | | IRP064 | | | SSR047 | SS047 | | 343 |
| To Suit Toyota Prado 120 Series 4/2003-10/2009 ¹ | | BBCD008 | | | | | | | | SSR004 | SS017 | | 346 |
| To Suit Toyota Prado 90, 95 Series 1996-10/2002 ¹ | | BBCD007 | | | | | | | | | | | 348 |
| To Suit Toyota Tacoma 2005+ | BBR072 - (Raid Full Length Bumper) | | | | | | | | RTB072 | | SS072 / SS072L | | 350 |
| To Suit Toyota Tundra 2013-2020 | BBR073 - (Raid Full Length Bumper) | | | | | | | | RTB073 | | SS073 | | 352 |
| To Suit Volkswagen Amarok V6 / 4 Cyl 11/2016+ | | BBCD060 | | | BBT060-NL | | | | RTB060 | SSR034 | SS034 | SS034 RAIL | 358 |
| To Suit Volkswagen Amarok 2011-10/2016 | | BBCD034 | BBT034 | | | | | | | SSR034 | SS034 | SS034 RAIL | 360 |

NOTES: * Only compatible with Synthetic Rope Winch and Alloy Hawse. ¹ Suits narrow body model. ¹ Suits flared guard model. ² Suits both 2WD and 4WD models. ³ Single and triple loop options available. ⁴ Not available in Australia. ⁵ Not suitable for vehicles with forward facing radar. ⁶ Not compatible with V6 model. ⁷ Suits GX model only. ⁸ Not compatible with sensors and headlight washers. ⁹ Narrow body Aus and NZ only. ⁹ Narrow body excludes Aus and NZ.



Snorkels

SNORKELS

| Vehicle Make | Model and Specifics | 3" Hat | 3.5" Hat | 4" Hat | Part Number | Page |
|---|--|--------|----------|--------|----------------|--------------------|
| To Suit Fiat Fullback | 2016+ | | | • | ISNORKEL050 | 45 |
| To Suit Ford Maverick | 1988-1994 - (All models except 2.8L Diesel) | • | | | ISNORKEL011 | 228 |
| To Suit Ford Ranger | Next-Gen 2022 | | • | | ISNORKEL110 | 50 |
| To Suit Ford Ranger | PX III XL 8/2018+ 3.2L Diesel (with side indicator) | | • | | ISNORKEL034 | 52 |
| To Suit Ford Ranger / Everest | PX III XLT 8/2018+ 3.2L Diesel (with indicator on side mirror) / UAll | | • | | ISNORKEL034XLT | 52, 67 |
| To Suit Ford Ranger | PX / PX II XL 7/2011+ 2.2 and 3.2L Diesel | | • | | ISNORKEL034 | 56, 60 |
| To Suit Ford Ranger | PX / PX II XLT 7/2011+ 2.2 and 3.2L Diesel | | • | | ISNORKEL034XLT | 56, 60 |
| To Suit Ford Ranger | PJ / PK 2006-2011+ - 3.0L TDI Diesel | | • | | ISNORKEL021 | 64 |
| To Suit GM / Holden Trailblazer | LT LTZ 2017+ | | • | | ISNORKEL036 | 76 |
| To Suit GM / Holden Colorado / Colorado 7 | RG 2012-2020 | | • | | ISNORKEL036 | 80, 83, 78 |
| To Suit GM / Holden Colorado | RC 2008-2012 | | • | | ISNORKEL028 | 87 |
| To Suit GM / Holden Rodeo | RA7 LX and LT 2007-7/2008 - (Does not fit DX Model) | | • | | ISNORKEL022 | 89 |
| To Suit Isuzu D-Max | 8/2019+ | | • | | ISNORKEL074 | 98 |
| To Suit Isuzu D-Max | 6/2012 to 7/2019 | | • | | ISNORKEL041 | 101, 104 |
| To Suit Isuzu D-Max | 2009-2012 - (Does not fit 4x2 SX Model) | | • | | ISNORKEL022 | 108 |
| To Suit Isuzu MU-X | 8/2021+ | | • | | ISNORKEL074 | 110 |
| To Suit Isuzu MU-X | 2014 to 7/2021 | | • | | ISNORKEL041 | 110 |
| To Suit Jeep Wrangler | JK 2007+ (Not available in Australia) | • | | | ISNORKEL032 | 126 |
| To Suit Mazda BT50 | 6/2020+ | | • | | ISNORKEL080 | 147 |
| To Suit Mazda BT50 | 11/2006-2012 - 3.0L TDI Diesel | | • | | ISNORKEL024 | 154 |
| To Suit Mitsubishi Triton | MR 11/2018+ | | • | | ISNORKEL067 | 178 |
| To Suit Mitsubishi Triton | MQ 2015-10/2018 - 2.4L Diesel | | | • | ISNORKEL050 | 182 |
| To Suit Mitsubishi Triton | ML / MN 2006-2015 | | • | | ISNORKEL020 | 187, 190 |
| To Suit Nissan Navara | NP300 2015+ - Suits Wide and Narrow Body 2.3L Twin and Single Turbo Diesel | | | • | ISNORKEL048 | 197, 200 |
| To Suit Nissan Navara | D40 2005+ (Does not suit 2010+ STX - Spain Build Single Cab) | | • | | ISNORKEL019 | 203 |
| To Suit Nissan Pathfinder | R51 2005-2013 | | • | | ISNORKEL019 | 210 |
| To Suit Nissan Patrol | GU Series 4 2005+ | | • | | ISNORKEL013 | 218 |
| To Suit Nissan Patrol | GU Series 1, 2 and 3 1998-2004 | • | | | ISNORKEL015 | 219 |
| To Suit Nissan Patrol | GQ 1987-1997 - (All models except 2.8L Diesel) | • | | | ISNORKEL011 | 228 |
| To Suit Suzuki Jimny | GJ 2018+ | | • | | ISNORKEL070 | 254 |
| To Suit Toyota Fortuner | 2015+ | | | • | ISNORKEL053 | 272 |
| To Suit Toyota Hilux | 8/2020+ 2.8L Turbo Diesel | | | • | ISNORKEL051 | 278 |
| To Suit Toyota Hilux | 8/2020+ Narrow Body Model | | • | | ISNORKEL076N | 278 |
| To Suit Toyota Hilux | Revo 2015-7/2020 - 2.8L Turbo Diesel | | | • | ISNORKEL051 | 282 |
| To Suit Toyota Hilux | Vigo 2005-2015 - 3.0L TDI, 4.0L Petrol V6 | | • | | ISNORKEL001 | 286 |
| To Suit Toyota Landcruiser | 300 Series 2022+ | | • | | ISNORKEL090 | 294 |
| To Suit Toyota Landcruiser | 200 Series 11/2015+ | | • | | ISNORKEL056 | 295 |
| To Suit Toyota Landcruiser | 200 Series 11/2007-10/2015 | | • | | ISNORKEL010 | 298 |
| To Suit Toyota Landcruiser / Lexus | 105 and 100 Series / LX 470 1998-2007 | | • | | ISNORKEL003 | 300, 303 |
| To Suit Toyota Landcruiser / Lexus | 80 Series / LX 450 1990-1998 | | • | | ISNORKEL004 | 293 |
| To Suit Toyota Landcruiser | 79 / 78 / 76 Series 2007+ | | • | | ISNORKEL023 | 308, 311, 315, 323 |
| To Suit Toyota Landcruiser | 75, 78, 79 Series 1984-2007 | | • | | ISNORKEL009 | 304, 319, 326 |
| To Suit Toyota Prado | 150 Series 11/2017+ 2.8L | | • | | ISNORKEL064 | 340 |
| To Suit Toyota Prado | 150 Series 11/2009-10/2017 3L D4D TDi / 4L Petrol V6 and 2.8L D4D TDi | | • | | ISNORKEL035 | 343 |
| To Suit Toyota Prado | 120 Series 2003-2009 3L D4D TDi / 4L Petrol V6 | | • | | ISNORKEL006 | 346 |
| To Suit Toyota Prado | 90 / 95 Series 1996-2002 3.4L Petrol V6 | • | | | ISNORKEL005 | 348 |
| To Suit Volkswagen Amarok | 2011+ | | | • | ISNORKEL037 | 358, 360 |

Underbody Protection

UNDERBODY PROTECTION

| Vehicle Make | Model and Specifics | Standard Part No. | Premium Part No. | Page |
|--|---|-------------------|------------------|--------------------|
| To Suit Fiat Fullback | 2016+ | IUP050K | UBP050 | 45 |
| To Suit Ford Ranger | Next-Gen 2022+ | | UBP110 | 50 |
| To Suit Ford Ranger | PX III 8/2018+ | | UBP055 | 52 |
| To Suit Ford Ranger | PX II 2015-7/2018 | IUP014K | UBP054 / UB055 | 56 |
| To Suit Ford Ranger | PX 7/2011-2015 | IUP014K | UBP054 | 60 |
| To Suit Ford Everest | UA II 7/2018+ | | UBP055 | 67 |
| To Suit Ford Everest | 9/2015-6/2018 | IUP014K | UBP054 | 69 |
| To Suit GM / Holden Colorado / Trailblazer | RG 11/2016-2020 / Trailblazer LT / LTZ 2017+ | | UBP057 | 76, 80 |
| To Suit GM / Holden Colorado | RG 2012-10/2016 / Colorado 7 RG 2012-2016 | | UBP041 | 78, 85 |
| To Suit GM / Holden Colorado | RC 2008-2012 | IUP009K | | 87 |
| To Suit GM / Holden Rodeo | RA and RA7 2002-2008 | IUP009K | | 89, 91 |
| To Suit Isuzu D-Max | 8/2019+ | | UBP074 / UB074S | 98 |
| To Suit Isuzu MU-X | 8/2021 | | UBP074S | 110 |
| To Suit Isuzu D-Max / MU-X | 6/2012 to 7/2019 / MU-X 2014 to 7/2021 | | UBP041 | 101, 104, 110 |
| To Suit Isuzu D-Max | 2007-06/2012 | IUP009K | | 108 |
| To Suit Mazda BT50 | 6/2020+ | | UBP074 / UB074S | 147 |
| To Suit Mazda BT50 | 2012-5/2020 | IUP014K | UBP054 / UB055 | 150 |
| To Suit Mitsubishi Pajero Sport | 7/2019+ | | UBP050 | 162 |
| To Suit Mitsubishi Triton | MR and MQ 2015+ | IUP050K | UBP050 | 178, 182 |
| To Suit Mitsubishi Triton | ML 2006-2009 | IUP010F | | 190 |
| To Suit Nissan Navara | NP300 2015-2020 (Series 1 / Series 2, 3 & 4) | | UBP048 / UB048S | 200 |
| To Suit Nissan Navara | D40 2005+ (Diesel only) | IUP007K | | 203 |
| To Suit Ram 1500 | DT 6/2018+ | | UBP085 | 238 |
| To Suit Ram 1500 | DS 2014+ | | UBP075 | 239 |
| To Suit Renault Alaskan | 2017+ (Series 1 / Series 2, 3 & 4) | | UBP048 / UB048S | 240 |
| To Suit SsangYong Musso / Rexton | Q200, Q201, Q205 and Q215 / Y400 10/2018+ | | UBP201SY | 243, 248 |
| To Suit Suzuki Jimny | GJ 2018+ | | UBP070 | 254 |
| To Suit Toyota 4Runner | Gen 5, N280 2009+ | | UBP047 | 264 |
| To Suit Toyota Fortuner / Hilux | 2015+ | | UBP051 | 272, 278, 282 |
| To Suit Toyota Hilux | Vigo 2005-2015 | IUP001K | UBP033 | 286 |
| To Suit Toyota Landcruiser | 300 Series 2022+ | | UBP110 | 294 |
| To Suit Toyota Landcruiser | 200 Series 2015+ | | UBP056 | 295 |
| To Suit Toyota Landcruiser | 200 Series 11/2007-10/2015 | IUP004K / IUP004F | | 298 |
| To Suit Toyota Landcruiser | 79 Series S/C 2007-8/2016 / 79 Series D/C 11/2012+ / 78/76 Series 2007+ | | UBP019 / UB019SC | 308, 311, 315, 323 |
| To Suit Toyota Prado | 150 Series 11/2009+ | | UBP047 | 340, 343 |
| To Suit Toyota Tacoma | 2005+ | | UBP072 | 350 |
| To Suit Toyota Tundra | 2013-2020 | | UBP073 | 352 |

REFER TO VEHICLE LISTING PAGES FOR SPECIFIC MODEL COMPATIBILITY / SUITABILITY

Roof Racks, Mount Kits and Roof Rail Extrusions

ATLAS RACK AND CROSSBAR KITS

* Platform / Crossbar load rating only.
Refer to vehicle manufacturer for specific roof load carrying capacity

| Vehicle Make (Suits) | Type / Description | Part Number | Load Rating* | Weight | Dimensions (mm) | | |
|---|----------------------------|---------------|--------------|--------|-----------------|------|----|
| ATLAS PLATFORM RACK KITS TO SUIT | | | KG | KG | L | W | H |
| Ford Ranger 2011+ | Platform A | IFR054PAK | 100 | 28 | 1530 | 1240 | 50 |
| Ford Ranger Wildtrack only 2022+ | Platform A | IFR110WTPAK | 100 | 27 | 1530 | 1240 | 50 |
| Ford Ranger Wildtrack only 2011-2022 | Platform A | IFR054WTPAK | 100 | 27 | 1530 | 1240 | 50 |
| Isuzu D-Max 2020+ / Mazda BT50 2020+ | Platform A | IFR074PAK | 100 | 27 | 1530 | 1240 | 50 |
| Mitsubishi Triton MQ / MR | Platform A | IFR067PAK | 100 | 27 | 1530 | 1240 | 50 |
| Nissan Navara NP300 | Platform B | IFR048PBK | 100 | 29 | 1530 | 1380 | 50 |
| Nissan Patrol Y62 | Platform K | IFR062LPNK | 100 | 39 | 2130 | 1380 | 50 |
| Toyota Hilux 2015+ | Platform A | IFR065PAK | 100 | 28 | 1530 | 1240 | 50 |
| Toyota Landcruiser 200 Series | Platform A | IFR056PAK | 100 | 27 | 1530 | 1240 | 50 |
| Toyota Landcruiser 200 Series | Platform E | IFR056PEK | 150 | 37 | 1530 | 1380 | 50 |
| Toyota Landcruiser 300 Series | Platform A | IFR090PAK | 100 | 27 | 1530 | 1240 | 50 |
| Toyota Landcruiser 300 Series | Platform E | IFR090PEK | 150 | 37 | 1530 | 1380 | 50 |
| Toyota Landcruiser 79 Series D/Cab | Platform S | IFR019PSK | 100 | 28 | 1390 | 1485 | 50 |
| Toyota Prado 150 | Platform E | IFR047PEK | 150 | 37 | 1530 | 1380 | 50 |
| To Suit Pinnacle 2 Canopies | Platform A | IFRP2PAK | 100 | 25 | 1530 | 1240 | 50 |
| To Suit Slideaway Hard Tonneau Cover | Platform A | IFRSLDAWAYPSK | 100 | 30 | 1530 | 1240 | 50 |
| ATLAS CROSSBAR KITS TO SUIT | | | KG | KG | L | W | H |
| Ford Ranger Next-Gen only 2022+ | Crossbars (2) with Fit Kit | IFR054C2K | 100 | 7 | - | 1250 | - |
| Ford Ranger Next-Gen Wildtrack only 2022+ | Crossbars (2) with Fit Kit | IFR110WTC2K | 100 | 7 | - | 1250 | - |
| Ford Ranger / Wildtrack 2011-2022 | Crossbars (2) with Fit Kit | IFR054C2K | 100 | 7 | - | 1250 | - |
| Isuzu D-Max 2020+ / Mazda BT50 2020+ | Crossbars (2) with Fit Kit | IFR074C2K | 100 | 7 | - | 1250 | - |
| Mitsubishi Triton MQ / MR | Crossbars (2) with Fit Kit | IFR067C2K | 100 | 7 | - | 1250 | - |
| Nissan Navara NP300 | Crossbars (2) with Fit Kit | IFR048C2K | 100 | 7 | - | 1250 | - |
| Suzuki Jimny GJ | Crossbars (2) with Fit Kit | IFR070C2K | 100 | 7 | - | 1250 | - |
| Toyota Hilux 2015+ | Crossbars (2) with Fit Kit | IFR065C2K | 100 | 7 | - | 1250 | - |
| Toyota Landcruiser 200 Series | Crossbars (3) with Fit Kit | IFR056C3K | 150 | 8 | - | 1375 | - |
| Toyota Landcruiser 79 Series D/Cab | Crossbars (2) with Fit Kit | IFR019C2K | 100 | 8 | - | 1650 | - |
| Toyota Prado 150 | Crossbars (3) with Fit Kit | IFR047C3K | 150 | 8 | - | 1375 | - |
| To Suit Pinnacle 2 Canopies | Crossbars (2) with Fit Kit | IFRP2C125K | 100 | 7 | - | 1250 | - |
| To Suit Pinnacle 2 Canopies | Crossbars (2) with Fit Kit | IFR074C2K | 100 | 8 | - | 1370 | - |
| To Suit Slideaway Hard Tonneau Cover | Crossbars (2) with Fit Kit | IFRSLDAWAYC2K | 100 | 10 | - | 1500 | - |

ROOF RACKS

| Description | Type | Part Number | Weight | Dimensions (mm) | | |
|--|-------------------------|------------------|--------|-----------------|------|-----|
| STEEL ROOF RACKS | | | KG | L | W | H |
| Steel Roof Rack | Cage Style | IRRCAGE14 | 37 | 1400 | 1250 | 150 |
| Steel Roof Rack | Cage Style | IRRCAGE18 | 46 | 1800 | 1250 | 150 |
| Steel Roof Rack | Cage Style | IRRCAGE22 | 52 | 2200 | 1250 | 150 |
| Steel Roof Rack | Rooftop Tent Compatible | IRRTENT18 | 37 | 1800 | 1250 | 150 |
| Steel Roof Rack | Rooftop Tent Compatible | IRRTENT22 | 45 | 2200 | 1250 | 150 |
| Steel Roof Rack - Open End | Trade Style | IRRTRADE18 | 42 | 1800 | 1250 | 150 |
| Steel Roof Rack - Open End | Trade Style | IRRTRADE22 | 49 | 2200 | 1250 | 150 |
| ALLOY ROOF RACKS | | | KG | L | W | H |
| Alloy Roof Rack - Mesh Floor | Cage Style | IRRCAGE14-ALLOY | 17 | 1400 | 1250 | 150 |
| Alloy Roof Rack - Mesh Floor | Cage Style | IRRCAGE18-ALLOY | 22 | 1800 | 1250 | 150 |
| Alloy Roof Rack - Mesh Floor | Cage Style | IRRCAGE22-ALLOY | 27 | 2200 | 1250 | 150 |
| Alloy Roof Rack - Mesh Floor, Open End | Trade Style | IRROPEN14-ALLOY | 16 | 1400 | 1250 | 150 |
| Alloy Roof Rack - Mesh Floor, Open End | Trade Style | IRRTRADE18-ALLOY | 20 | 1800 | 1250 | 150 |
| Alloy Roof Rack - Mesh Floor, Open End | Trade Style | IRRTRADE22-ALLOY | 25 | 2200 | 1250 | 150 |
| Alloy Roof Rack - Mesh Floor | Flat Style | IRRTFLAT18-ALLOY | 18 | 1800 | 1250 | 30 |

MOUNT KITS

| Description | Feet | Part Number | Height |
|--|--------------|-----------------|------------|
| 100mm Gutter Mount | 8 Feet | IRRFEET100 | 100 |
| 125mm Gutter Mount | 8 Feet | IRRFEET125 | 125 |
| 150mm Gutter Mount | 8 Feet | IRRFEET150 | 150 |
| 210mm Gutter Mount | 8 Feet | IRRFEET210 | 210 |
| To Suit Landcruiser 100 / 105 Series Roof Mount | 8 Feet | IRRFEETLC100 | Adjustable |
| To Suit Landcruiser 200 Series Roof Mount | 8 Feet | IRRFEETLC200 | Adjustable |
| To Suit GM / Holden Colorado 7 / Trailblazer | 6 Feet | IRRFEET001 | Fixed |
| To Suit Toyota Prado 150 | 2 Feet | IRRFEETPRADO150 | Fixed |
| To Suit Isuzu MU-X - Replaces Roof Rails | 4 Feet | IRRFEETMUX | Fixed |
| ABS Canopies 010 / 011 / 012 / 013 / 014 / 015 / 019 / 020 | 4 (2 pieces) | IRRFEETABS14 | 45 |



Canopies

ABS PLASTIC CANOPIES - GENERIC LISTING (WEIGHT 80KG)

| Vehicle Make | Model and Specifics | Part Number | Page |
|---------------------------|---|------------------------|----------------|
| To Suit Fiat Fullback | 2016+ | CANOPY014 | 45 |
| To Suit Ford Ranger | PX 2011-2015* / PX II 2015-7/2018 / PX III 8/2018+ / Raptor 9/2018+ | CANOPY010* | 50, 53, 57, 61 |
| To Suit Isuzu D-Max | 6/2012 to 7/2019 | CANOPY020* | 101, 104 |
| To Suit Mazda BT50 | 2012 to 5/2020 | CANOPY010* / CANOPY018 | 151 |
| To Suit Mitsubishi Triton | MR 11/2018+ / MQ 2015-10/2018 | CANOPY014 | 179, 183 |
| To Suit Nissan Navara | NP300 2015 to 2020 | CANOPY013* | 200 |
| To Suit Renault Alaskan | 2017+ | CANOPY013* | 240 |
| To Suit Toyota Hilux | 2015+ | CANOPY017-SW | 283 |
| To Suit Volkswagen Amarok | 2011+ | CANOPY021 | 358, 360 |

* Colour coded options available

PINNACLE FIBREGLASS CANOPIES - GENERIC LISTING (WEIGHT 100KG)

| Vehicle Make | Model and Specifics | Part Number | Page |
|---------------------------|---|--------------|----------------|
| To Suit Fiat Fullback | 2016+ | CANFIBRE050* | 45 |
| To Suit Ford Ranger | PX 2011-2015* / PX II 2015-7/2018 / PX III 8/2018+ / Raptor 9/2018+ | CANFIBRE054* | 50, 53, 57, 61 |
| To Suit LDV T60 | 2017+ | CANFIBRE051* | 142 |
| To Suit Mazda BT50 | 2012 to 5/2020 | CANFIBRE054* | 151 |
| To Suit Mitsubishi Triton | MR 11/2018+ / MQ 2015-10/2018 | CANFIBRE050* | 179, 183 |
| To Suit Nissan Navara | NP300 2015 to 2020 | CANFIBRE048* | 201 |
| To Suit Renault Alaskan | 2017+ | CANFIBRE048* | 241 |
| To Suit Toyota Hilux | 2015+ | CANFIBRE051* | 279, 283 |

* Colour coded options available

PINNACLE 2 FIBREGLASS CANOPIES - GENERIC LISTING (WEIGHT 100KG)

| Vehicle Make | Model and Specifics | Part Number | Page |
|---------------------------|---|-------------|----------------|
| To Suit Fiat Fullback | 2016+ | ICANOPY050* | 45 |
| To Suit Ford Ranger | Next-Gen 2022+ | ICANOPY110* | 50 |
| To Suit Ford Ranger | PX 2011-2015* / PX II 2015-7/2018 / PX III 8/2018+ / Raptor 9/2018+ | ICANOPY054* | 49, 53, 57, 61 |
| To Suit D-Max | 8/2019+ | ICANOPY074* | 98 |
| To Suit Mazda BT50 | 6/2020+ | ICANOPY074* | 147 |
| To Suit Mazda BT50 | 2012 to 5/2020 | ICANOPY054* | 151 |
| To Suit Mitsubishi Triton | MR 11/2018+ / MQ 2015-10/2018 | ICANOPY050* | 179, 183 |
| To Suit Nissan Navara | 2021+ | ICANOPY082* | 197 |
| To Suit Toyota Hilux | 2015+ | ICANOPY051* | 279, 283 |
| To Suit Volkswagen Amarok | 2011+ | ICANOPY060* | 358, 360 |

* Colour coded options available

REFER TO VEHICLE LISTING PAGES FOR SPECIFIC MODEL COMPATIBILITY / SUITABILITY

LED Driving Lights

LED DRIVING LIGHTS

IDL0701C Op. Volt: 10-32V DC

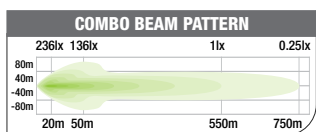
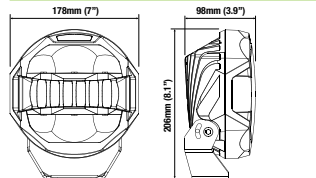

IDL0701S Op. Volt: 10-32V DC

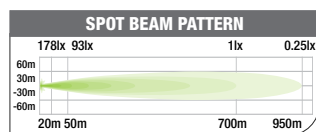
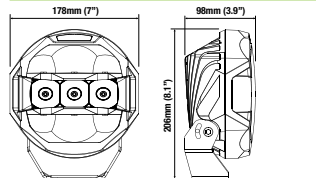

IDL0901C Op. Volt: 10-32V DC

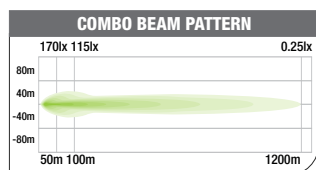
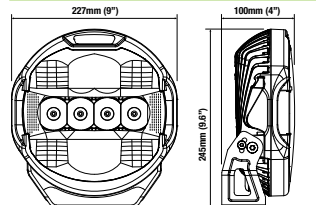

IDL0901S Op. Volt: 10-32V DC

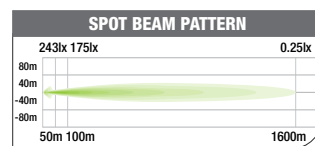
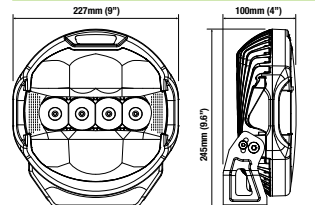

ILED5X7 Op. Volt: 12-24V DC

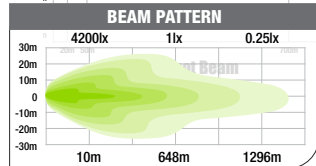
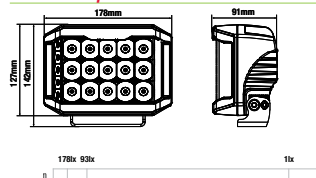

ILEDBLAST2C Op. Volt: 12-24V DC

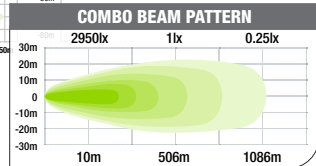
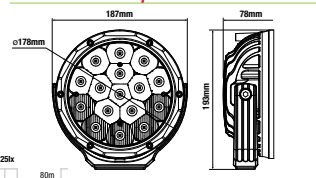

ILEDBLAST2S Op. Volt: 12-24V DC

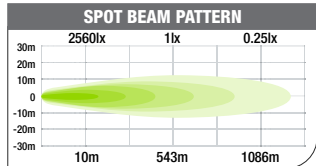
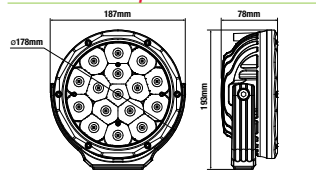

ILED7M Op. Volt: 12-24V DC

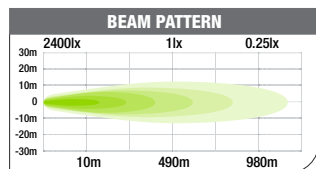
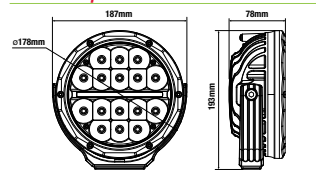

ILED9M Op. Volt: 12-24V DC

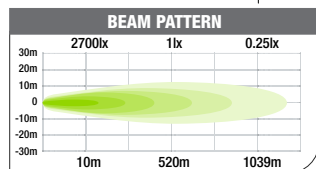
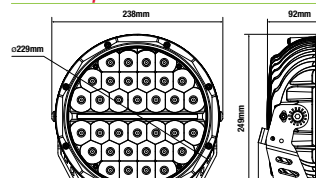

ILED7C Op. Volt: 12-24V DC

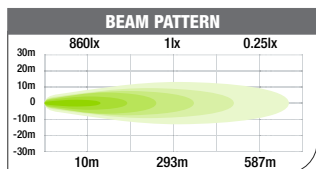
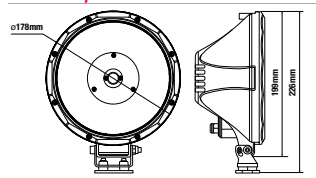

ILED9C Op. Volt: 12-24V DC

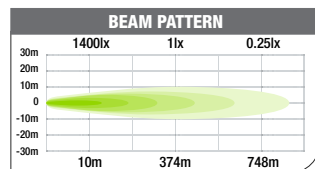
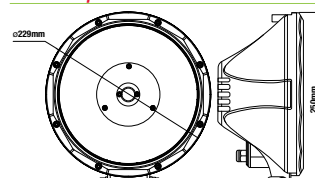

IMEGATOM Op. Volt: 9-30V DC

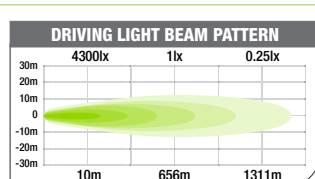
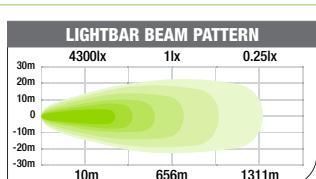
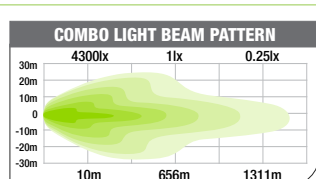
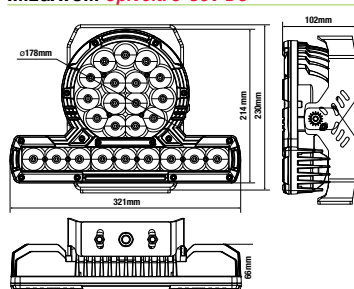

LED Work Lights and Upgrades

LED WORK AND UNIVERSAL LIGHTS

Operating Voltage: 12-24V DC

ILEDWL10 / ILEDWL10FA

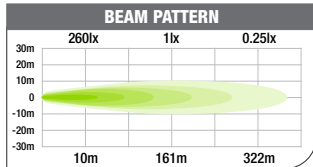
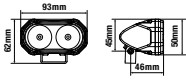

ILEDUNI3

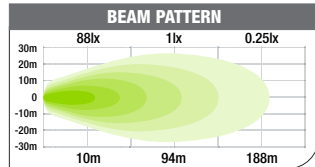
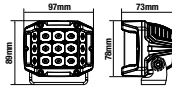

ILEDUNI5

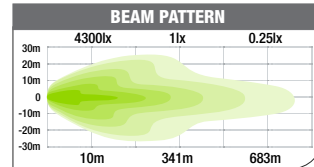
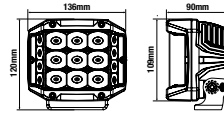

IRL120B

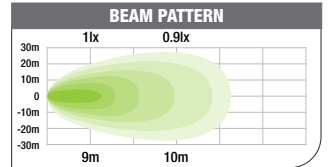
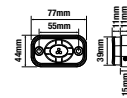

ILED20B SERIES

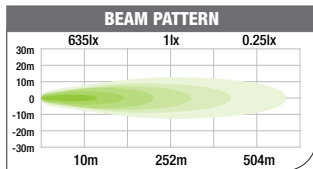
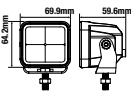

ILED20BF SERIES

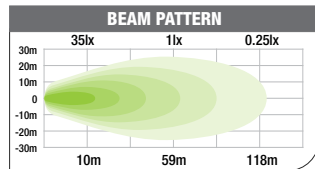
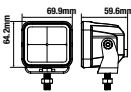

ILED80B SERIES

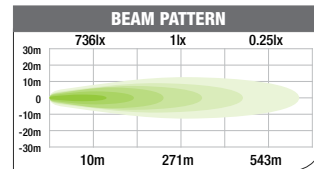
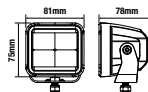

ILED80BF SERIES

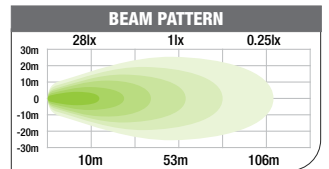
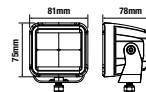

ILEDGOSMO

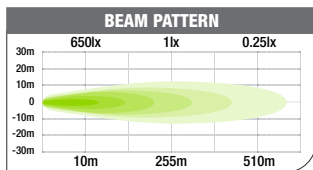
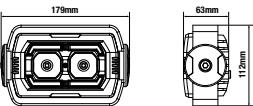

ILED5B

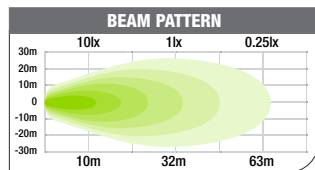
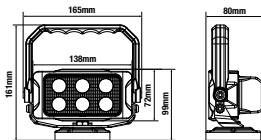

BULL BAR UPGRADE LED LIGHTS

BBPART031

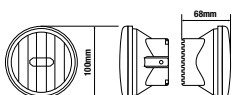

Operating Voltage: 9-32V DC

BBPART002

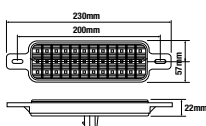

Operating Voltage: 12V DC

LED Lightbars

SINGLE ROW - SLIM

Operating Voltage: 12-24V DC

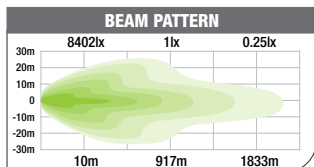
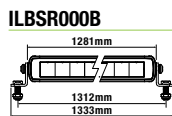
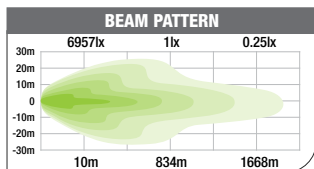
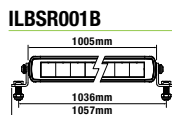
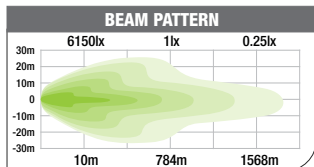
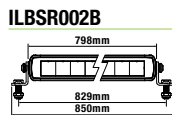
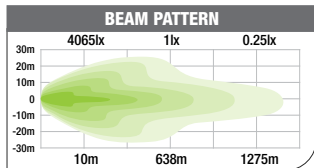
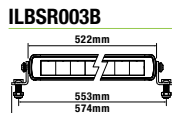
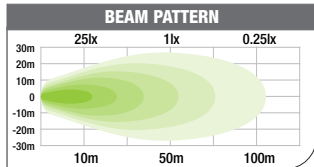
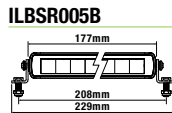
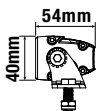

SINGLE ROW - WIDE

Operating Voltage: 12-24V DC

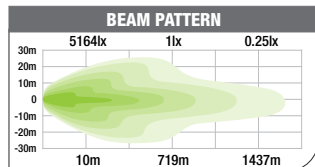
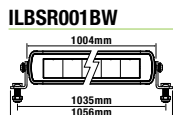
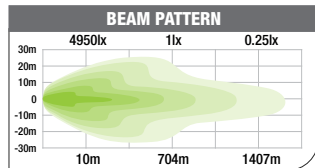
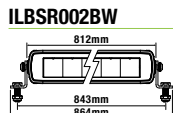
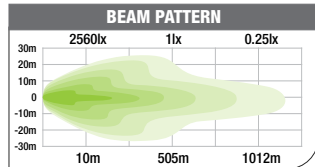
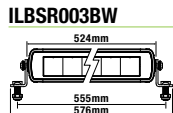
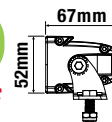

DUAL ROW

Operating Voltage: 12-24V DC

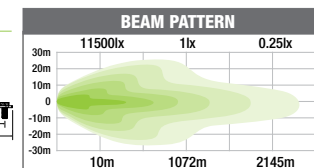
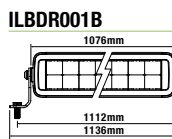
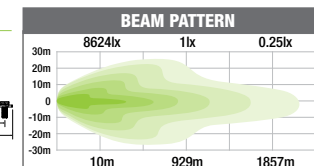
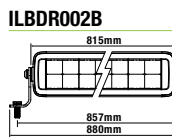
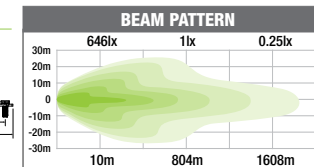
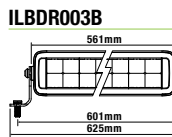
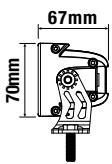

DUAL ROW - MULTI FUNCTION

Operating Voltage: 12-24V DC

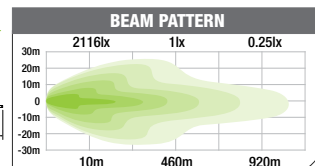
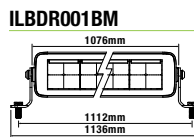
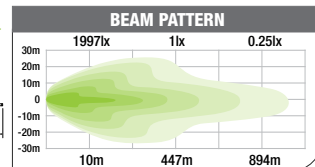
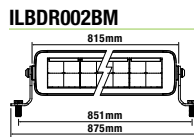
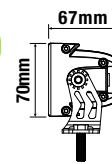

LED Lightbars and Light Wire Looms

LED LIGHT BARS - STRAIGHT

Operating Voltage: 12-24V DC

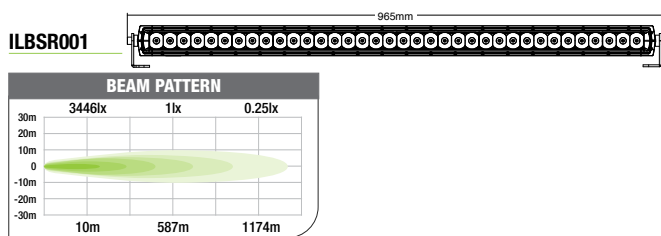
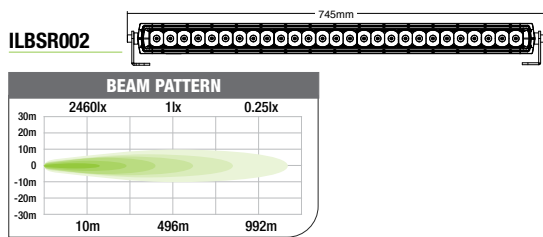
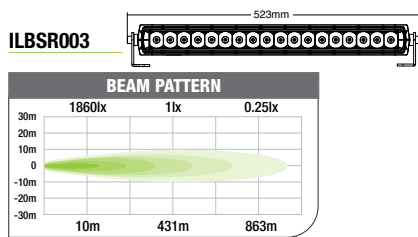
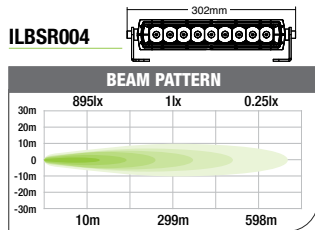

LED LIGHT BARS - CURVED

Operating Voltage: 12-24V DC

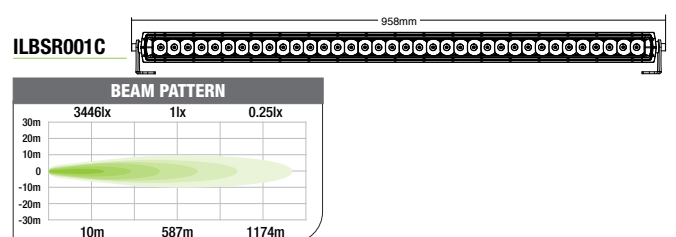
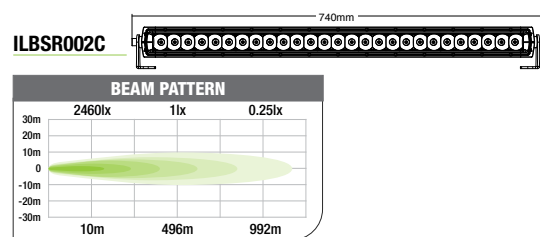
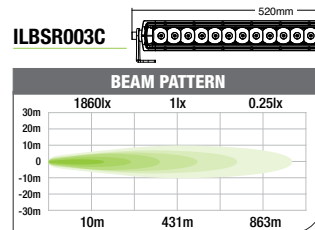

LED LIGHT BARS - MODULAR

Operating Voltage: 12-24V DC

ILED180S (SPOT)

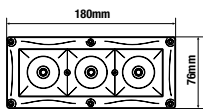

30W Spot Beam (7") Long

ILED180F (FLOOD)

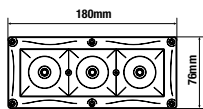

30W Flood Beam (7") Long

MODULAR COMBINATIONS

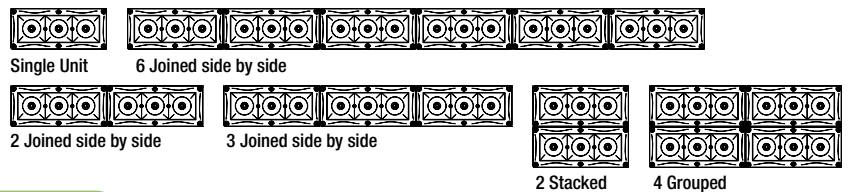

LED DRIVING LIGHTS / LIGHTBAR WIRE LOOMS

SINGLE LIGHT LOOM

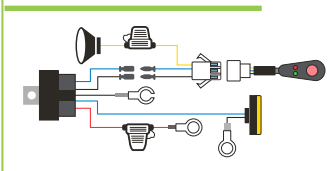

TWIN LIGHT LOOM

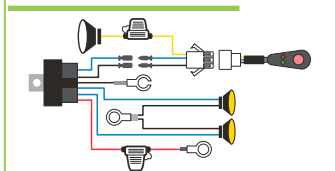

TWIN LIGHT WITH DRL LOOM

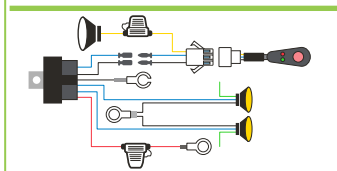

TWIN MEGATOM LOOM

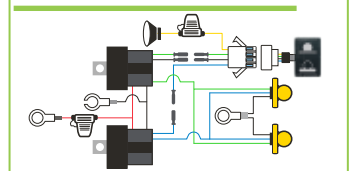

Fridges and Fridge Troubleshooting

FRIDGE ERROR CODES

EXISTING AND SUPERSEDED FRIDGE RANGE

| Code | Error Type - Refer to User Manual for further information | Possible solution |
|------------|--|--|
| E1 | Battery protection stop auto cut-off (Battery too low or adjust protection setting) | Set battery protection to lower setting. |
| E2 | Fan fault (Check clearance around the fan) | Check for fan obstructions. |
| E3 | Compressor motor starter error (Low voltage power supply) | Check available voltage of 12/24V power supply, check all connections between battery and fridge, check condition of plug in lead. |
| E4 | Compressor motor running speed error (Overloaded motor cannot maintain 1850 times / min which is the lowest speed) | Return to place of purchase for assessment. |
| E5 | Compressor has over heated (Check clearance around the fan) | Check for sufficient air flow clearance around fridge. |
| ER1 | Control panel and temperature probe fault | Replacement of control panel or temperature probe. |

METAL FRIDGE RANGE

| Code | Error Type - Refer to User Manual for further information | Possible solution |
|-------------------|---|---|
| ERR01 | Battery cut-out activated | Check source voltage is above the set cut-out level and adjust as required. Check operation on another power source. |
| ERR02 | Cooling fan issue | Call Ironman 4x4 Customer Service. |
| ERR03 | Compressor start-up issue | Remove fridge from power source and wait 10 mins before reconnecting. Try connection to an alternate power source. Potential control system issue, contact Ironman 4x4 Customer Service. |
| ERR04 | Compressor speed too low | Remove fridge from power source and wait 10 mins before reconnecting. Try connection to an alternate power source. Move unit to a lower ambient temperature area. Clean and verify all vents are clear to ensure uninterrupted air-flow across compressor and cooling system. |
| ERR05 | Extreme ambient temperature | Move unit to a lower ambient temperature area. Clean and verify all vents are clear to ensure uninterrupted air-flow across compressor and cooling system. |
| ERR06 / 07 | Thermostat failure | Call Ironman 4x4 Customer Service. |

Unit will not turn on

- Check power supply ie. Battery voltage (See Battery Protection table on Page 5 of User Handbook)
- Check all connections between battery and fridge
- Check condition of fuse
- Check that the unit is turned on

Poor refrigeration performance

- Too much food has been placed inside refrigerator
- Temperature of food placed in fridge is too high
- The door is not closed properly
- Door seal is broken

Poor cooling

- Make sure adequate ventilation room is left around unit (See General Notes Page 4 of User Handbook)
- Ambient temperature is extremely high
- Temperature is not set correctly

Contents of fridge are freezing

- Temperature setting is too low

Noise

- Unit is not on a flat or level surface
- Check for vibrations in surrounding objects

Sound of water from inside of unit

- This is normal due to flow of refrigerant

FRIDGE FAQ's

Q. Where can I find a list of the fault codes? **A.** See User Handbook (or above)

Q. Why is my fridge freezing everything? **A.** Temperature is set to degrees Fahrenheit, reset to degrees Celsius

Q. My fridge will not turn on? **A.** Hold On/Off button until the display illuminates

Q. My fridge isn't staying on? **A.** Check the battery protection setting, and ensure it is set correctly by referring to your User Handbook



Fridges and Slides

FRIDGE / FREEZERS

30L (7.9GAL) ICECUBE FRIDGE / FREEZER - IFRIDGE30SP

Overall Dimensions 590(L) (650mm with handle) x 380(H) x 340mm(W)
23.3(L) (25.6"mm with handle) x 15(H) x 13.4"(W)
Weight 18kg (35lb)
Temperature Range / Regulation +10°C to -18°C (+50°F to -0.4°F)
Power Draw 4.5Amps

40L (10.5GAL) ICECUBE FRIDGE / FREEZER - IFRIDGE40SP

Overall Dimensions 590(L) (650mm with handle) x 440(H) x 350mm(W)
23.3(L) (25.6"mm with handle) x 17.4(H) x 13.8"(W)
Weight 20kg (37lb)
Temperature Range / Regulation +10°C to -18°C (+50°F to -0.4°F)
Power Draw 4.5Amps

50L (13GAL) ICECUBE FRIDGE / FREEZER - IFRIDGE50SP

Overall Dimensions 590(L) (650mm with handle) x 520(H) x 350mm(W)
23.3(L) (25.6"mm with handle) x 20.5(H) x 13.8"(W)
Weight 22kg (41lb)
Temperature Range / Regulation +10°C to -18°C (+50°F to -0.4°F)
Power Draw 4.5Amps

43L (11GAL) ICECUBE FRIDGE / FREEZER - IFRIDGE43LM

Overall Dimensions 630(L) x 517(H) x 365mm(W)
24.8(L) x 20.4(H) x 14.4"(W)
Weight 25kg (56lb)
Temperature Range / Regulation +10°C to -18°C (+50°F to -0.4°F)
Power Draw 4.5Amps

65L (17GAL) ICECUBE DUAL ZONE FRIDGE / FREEZER - IFRIDGE65LDZM

Overall Dimensions 800(L) x 470(H) x 475mm(W)
31.5(L) x 18.5(H) x 18.7"(W)
Weight 29kg (63.9lb)
Temperature Range / Regulation +10°C to -18°C (+50°F to -0.4°F)
Power Draw 4.5Amps

70L (18GAL) ICECUBE FRIDGE / FREEZER - IFRIDGE70LM

Overall Dimensions 800(L) x 470(H) x 475mm(W)
31.5(L) x 18.5(H) x 18.7"(W)
Weight 25kg (56lb)
Temperature Range / Regulation +10°C to -18°C (+50°F to -0.4°F)
Power Draw 4.5Amps

65L (17GAL) ICECUBE FRIDGE / FREEZER - IFRIDGE65SP (SUPERSEDED MODEL)

Overall Dimensions 820(L) x 495(H) x 490mm(W)
32.3(L) x 19.5(H) x 19.3"(W)
Weight 33kg (66lb)
Temperature Range / Regulation +10°C to -18°C (+50°F to -0.4°F)
Power Draw 4.5Amps

74L (19.5GAL) ICECUBE FRIDGE / FREEZER - IFRIDGE74SP (SUPERSEDED MODEL)

Overall Dimensions 820(L) x 495(H) x 490mm(W)
32.3(L) x 19.5(H) x 19.3"(W)
Weight 32kg (66lb)
Temperature Range / Regulation +10°C to -18°C (+50°F to -0.4°F)
Power Draw 4.5Amps

FRIDGE SLIDES

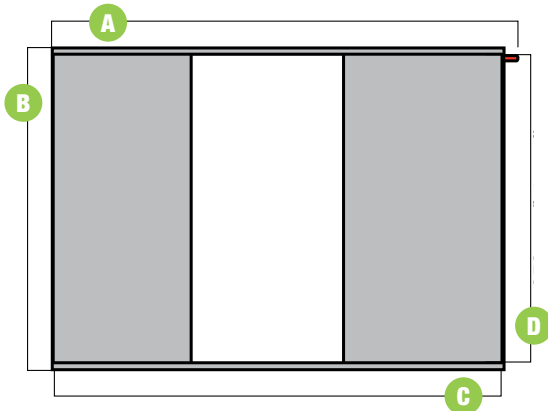

| | IFRIDGESLIDE001 | IFRIDGESLIDE002 | IFRIDGESLIDE023 | IFRIDGESLIDE034 | IFRIDGESLIDE045 |
|---------------|-----------------|-----------------|-----------------|-----------------|-----------------|
| A | 655mm | 843mm | 902mm | 796mm | 902mm |
| B | 420mm | 534mm | 576mm | 576mm | 676mm |
| C | 352mm | 811mm | 850mm | 750mm | 850mm |
| D | 592mm | 484mm | 530mm | 430mm | 530mm |
| TILT | No | No | No | Yes | Yes |
| WEIGHT | 21kg | 25kg | 21kg | 21kg | 31kg |

Locksafe Drawer Systems

LOCKSAFE DRAWER SYSTEMS

| 900mm Drawer System | Weight | Length (mm) | Height (mm) | Width (mm) |
|---|--------|-------------|-------------|------------|
| TWIN - Cabinet specifications including drawers* | 63kg | 900 | 275 | 970 |
| TWIN - Drawer specifications | | 840 | 206 | 425 |
| SINGLE - Cabinet specifications including drawers* | 34kg | 900 | 275 | 490 |
| SINGLE - Drawer specifications | | 840 | 206 | 425 |

| 1000mm Drawer System | Weight | Length (mm) | Height (mm) | Width (mm) |
|---|--------|-------------|-------------|------------|
| TWIN - Cabinet specifications including drawers* | 76kg | 1000 | 275 | 1020 |
| TWIN - Drawer specifications | | 940 | 206 | 450 |
| SINGLE - Cabinet specifications including drawers* | 39kg | 1000 | 275 | 510 |
| SINGLE - Drawer specifications | | 940 | 206 | 425 |

| 1300mm Drawer System | Weight | Length (mm) | Height (mm) | Width (mm) |
|---|--------|-------------|-------------|------------|
| TWIN - Cabinet specifications including drawers* | 89kg | 1300 | 275 | 970 |
| TWIN - Drawer specifications | | 1240 | 206 | 425 |
| SINGLE - Cabinet specifications including drawers* | 46kg | 1300 | 275 | 490 |
| SINGLE - Drawer specifications | | 1240 | 206 | 425 |

* Top of timber to underside of fixing ribs

TWIN DRAWERS

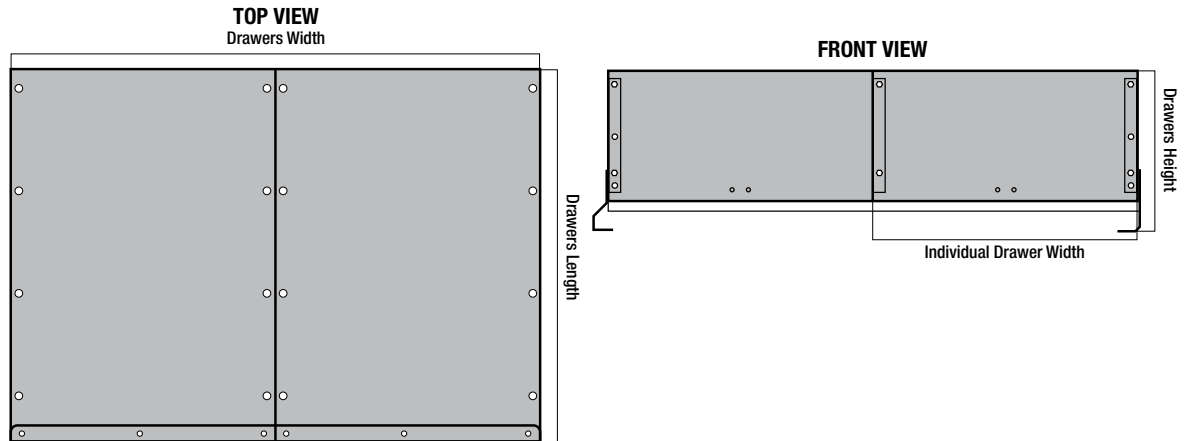

SINGLE DRAWERS

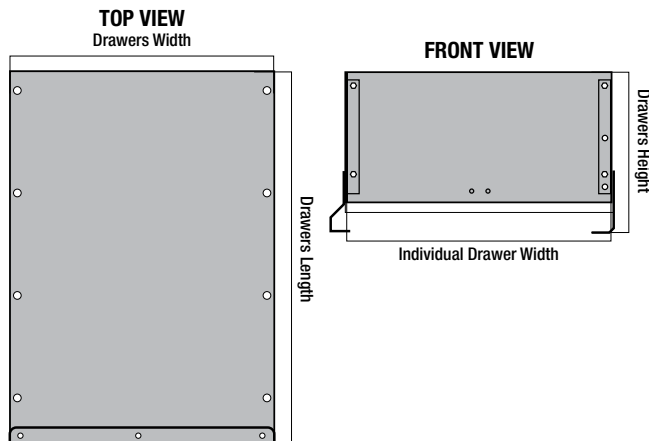

• All drawers extend 950mm from rear of unit. For an absolute overall width of each cabinet, add 26mm to the widths given above. Basic cabinet height is 238mm with 12mm carpeted ply on top and 20mm high fixing ribs under, giving an overall height of 270mm

REFER TO VEHICLE LISTING PAGES FOR SPECIFIC MODEL COMPATIBILITY / SUITABILITY

DeltaWing Awnings

DELTAWING 270 XTR-143 - (WEIGHT 20KG)

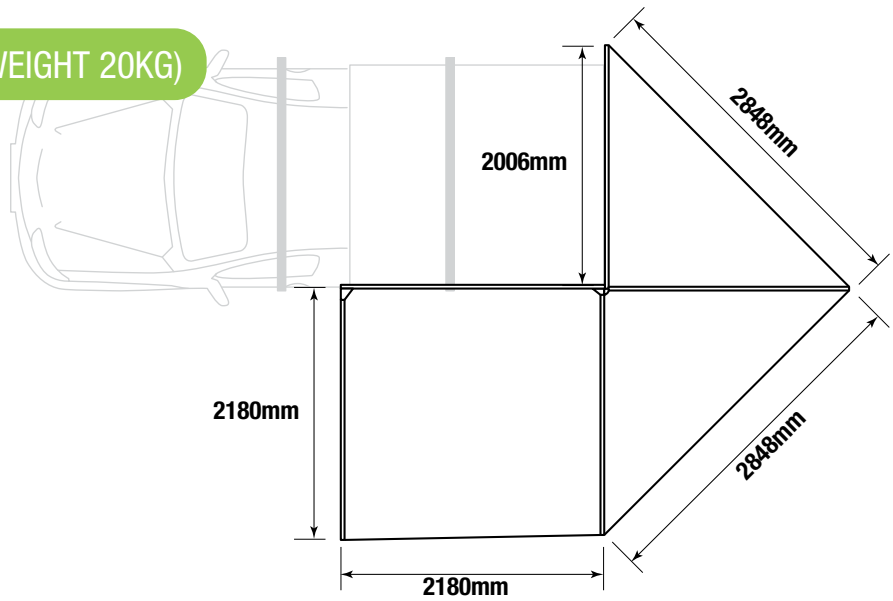

DELTAWING 270 XTR-71 - (WEIGHT 20KG)

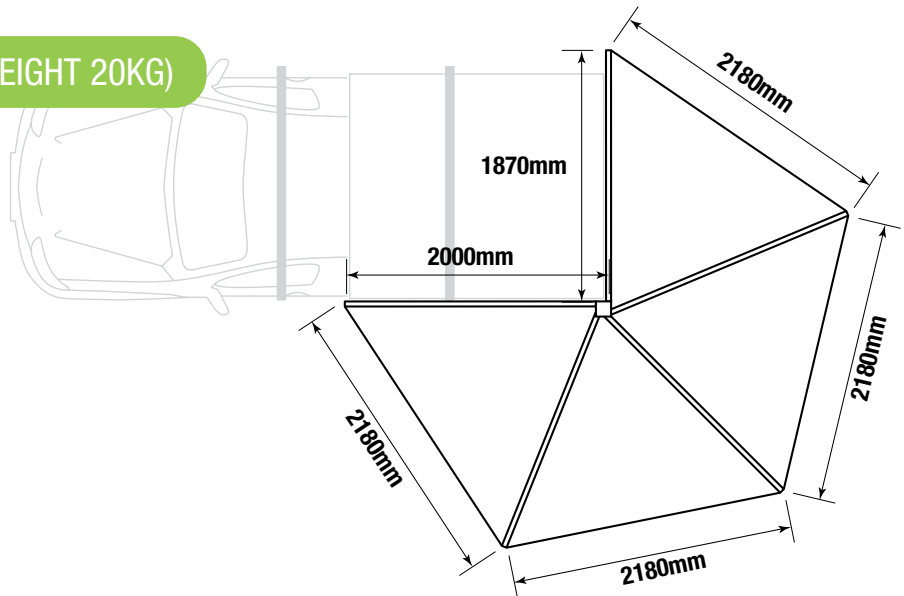

DELTAWING 270 XT-71 - (WEIGHT 18KG)

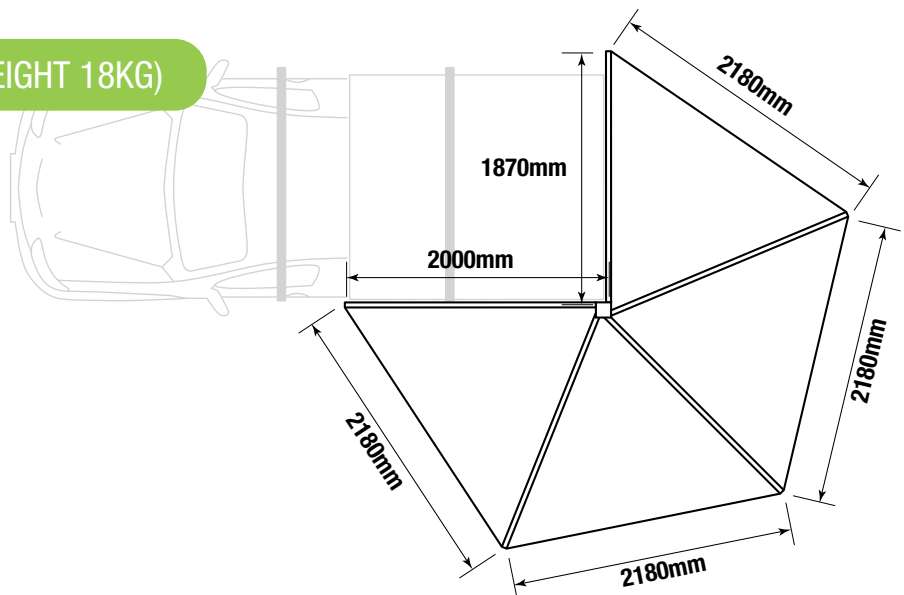

Rooftop Tents

SOFT ROOFTOP TENT - (WEIGHT 62KG)

OPEN

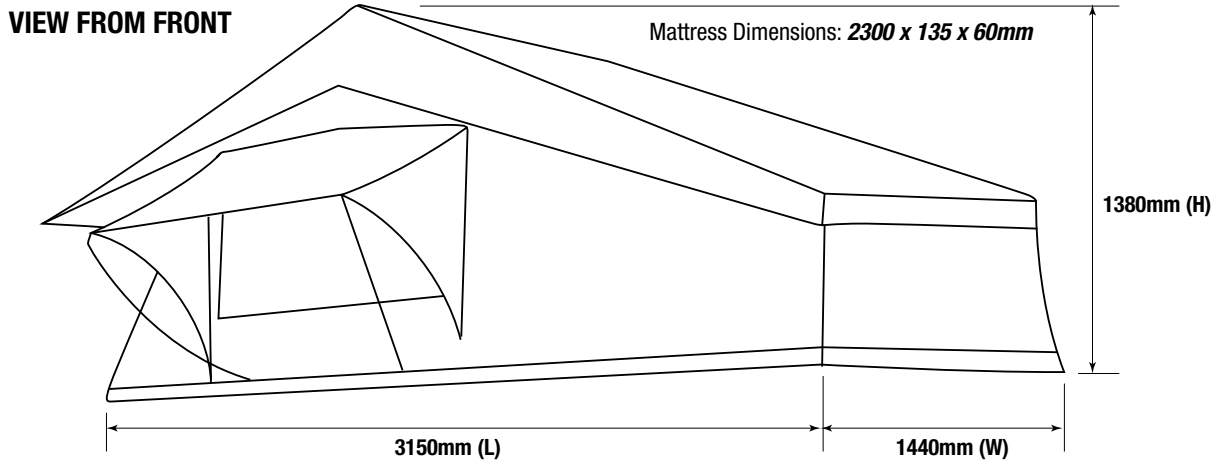

CLOSED

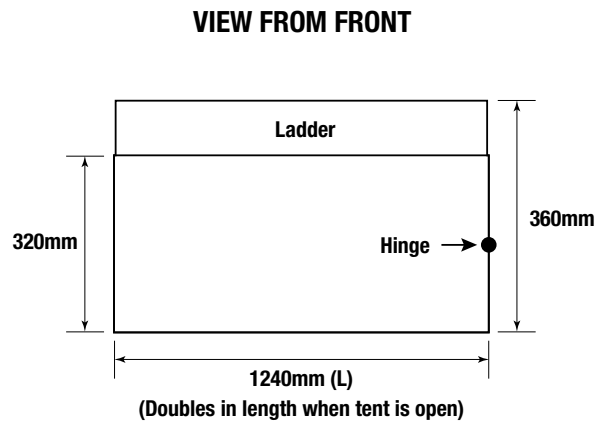
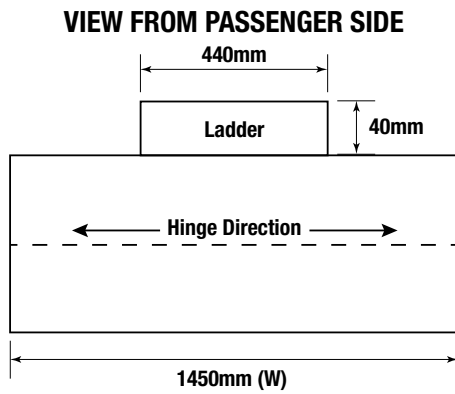

SWIFT 1400 HARD TOP ROOFTOP TENT - (WEIGHT 92KG)

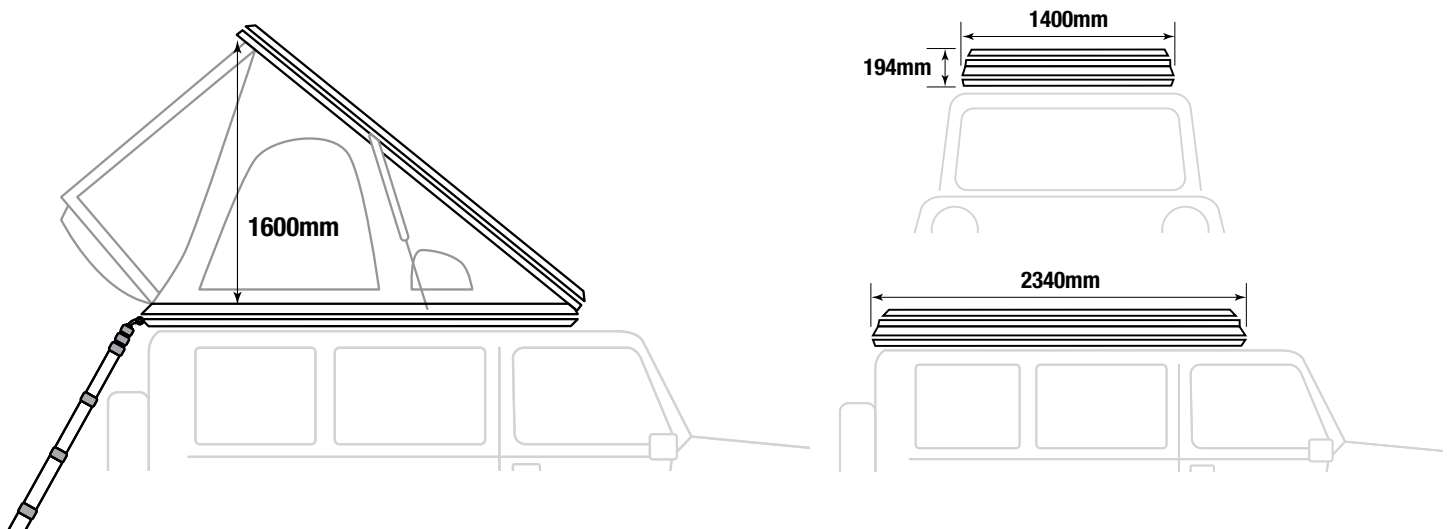

Rooftop Tents and Rooftop Tent Awning

NOMAD 1300 ABS ROOFTOP TENT - (WEIGHT 69KG)

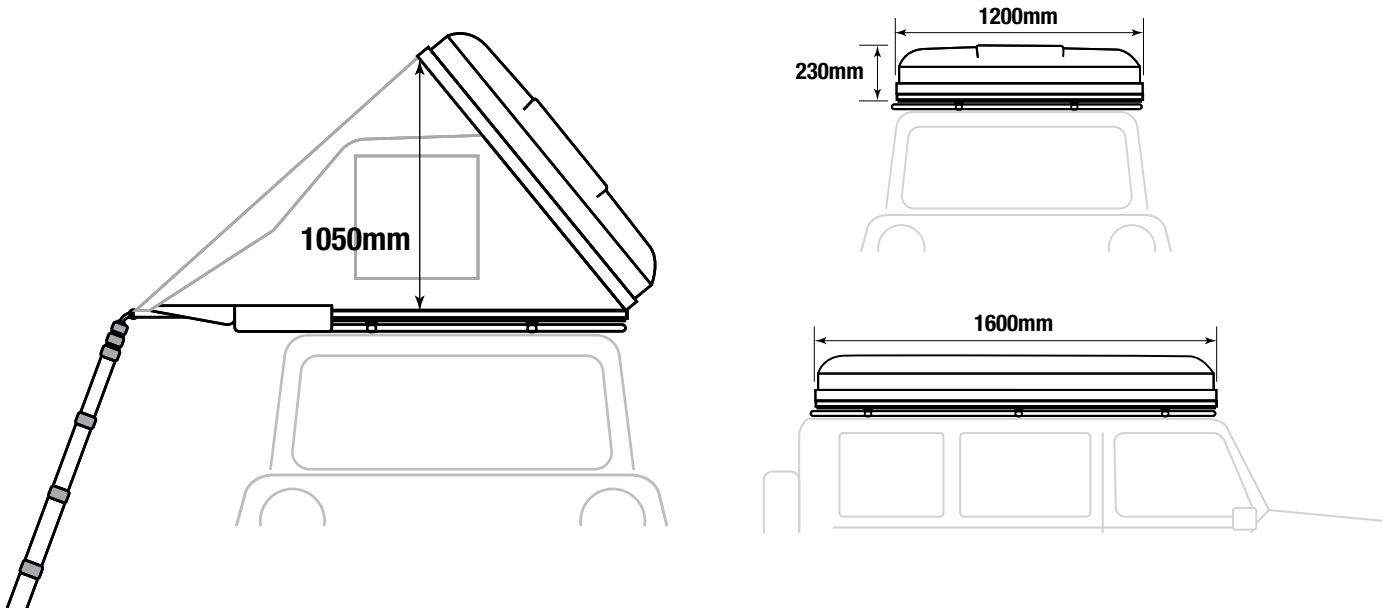

NOMAD 1300 ROOFTOP TENT AWNING - (WEIGHT 3KG)

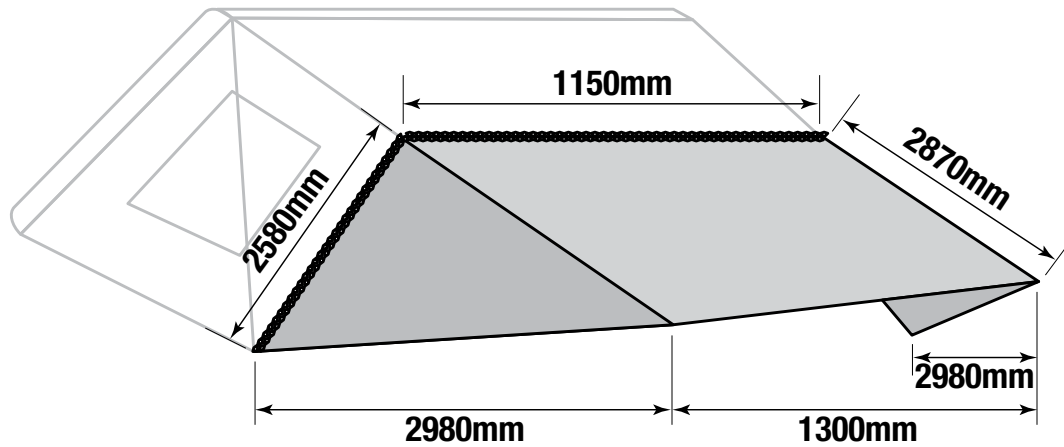

Rooftop Tents

SOFT ROOFTOP TENT ANNEX WITH EXTENSION KIT - (WEIGHT 9KG)

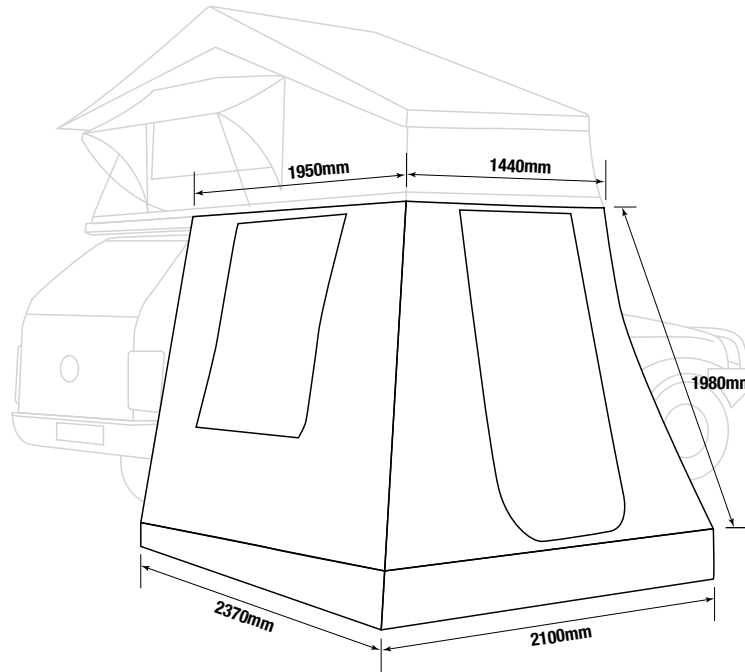

AWNING ROOM - (WEIGHT 11-12KG)

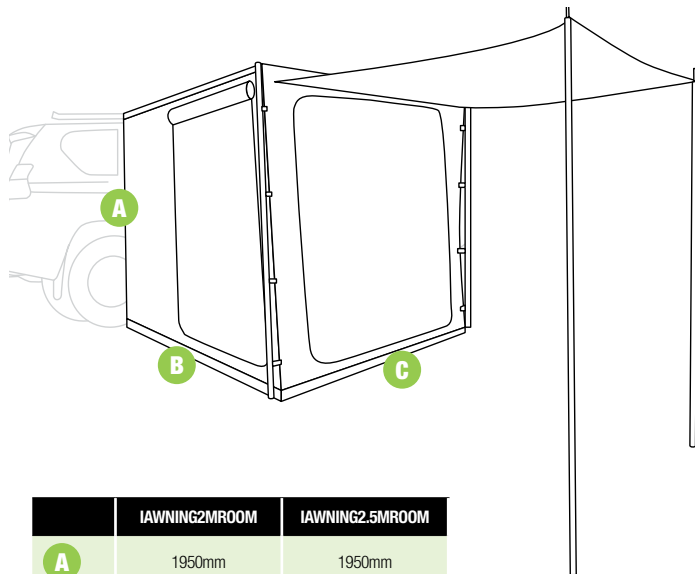

INSTANT ENSUITE - (WEIGHT 8KG)

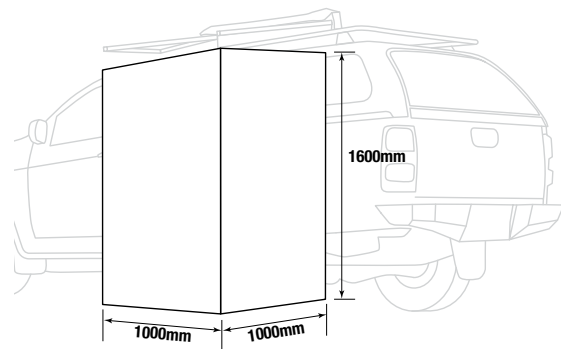

| | IAWNING2MRROOM | IAWNING2.5MRROOM |
|----------|----------------|------------------|
| A | 1950mm | 1950mm |
| B | 1880mm | 1800mm |
| C | 2000mm | 2500mm |

Rooftop Tents and Rooftop Tent Awning

LED INSTANT AWNING

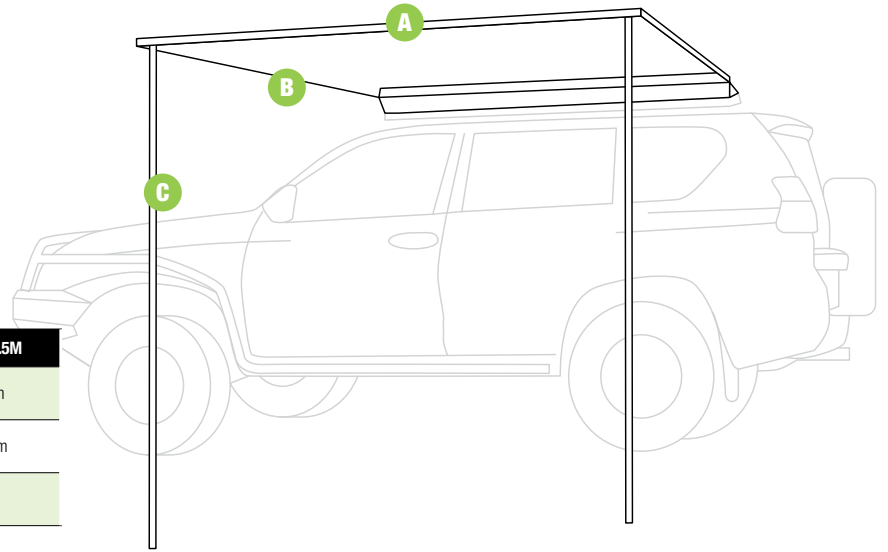

| | IAWNING1.4M | IAWNING2M | IAWNING2.5M |
|----------|-------------|-----------|-------------|
| A | 1400mm | 2000mm | 2500mm |
| B | 2000mm | 2000mm | 2000mm |
| C | Variable | Variable | Variable |

SWAGS

SINGLE SWAG - HOOP DESIGN

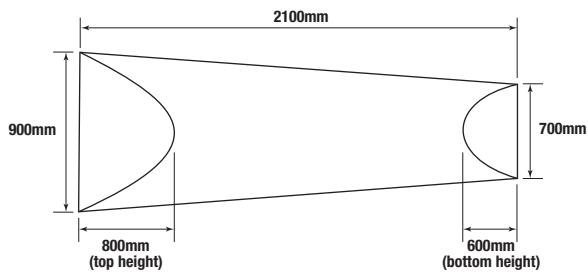

DOUBLE SWAG - HOOP DESIGN

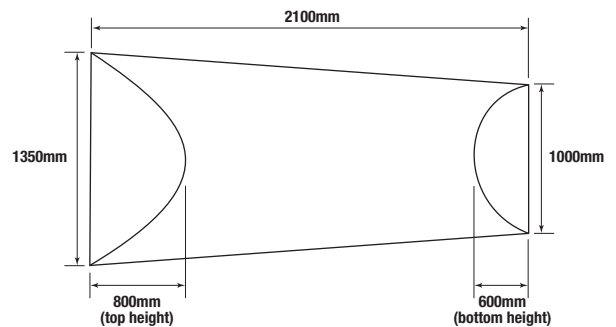

KING SINGLE SWAG - RIDGE POLE DESIGN

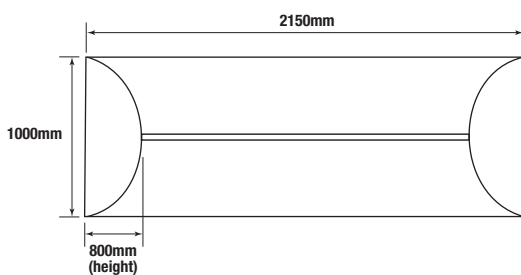

DOUBLE SWAG - RIDGE POLE DESIGN

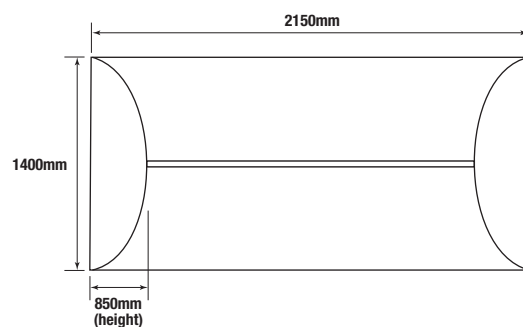

WATER TANKS

IWT001 - 20L JERRY CAN

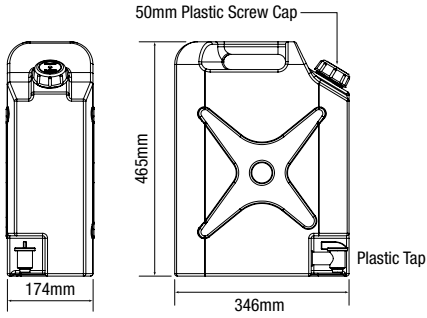

IWT002 - 40L JERRY CAN

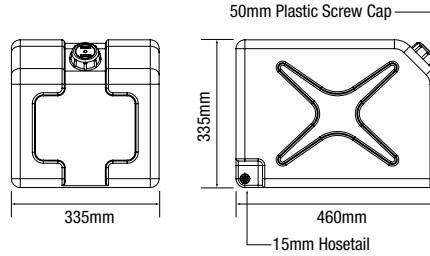

IWT003 - 40L VERTICAL TANK

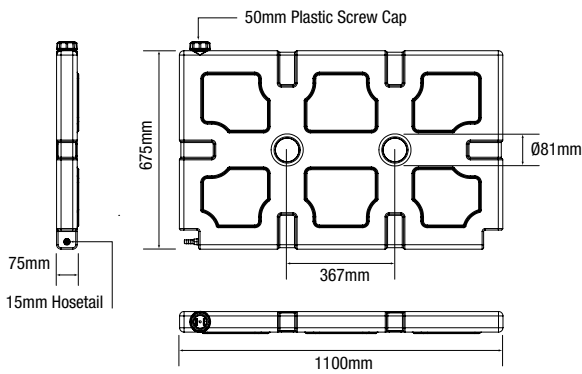

IWT004 - 50L ROOF RACK TANK

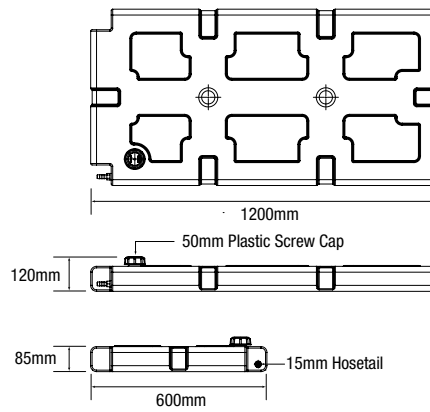

IWT005 - 50L WHEEL ARCH TANK

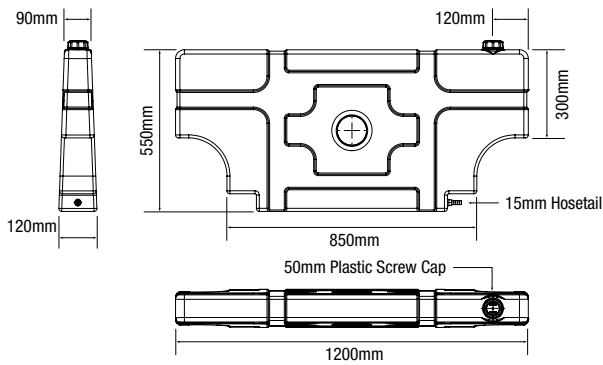

IWT006 - 50L TAPERED TANK

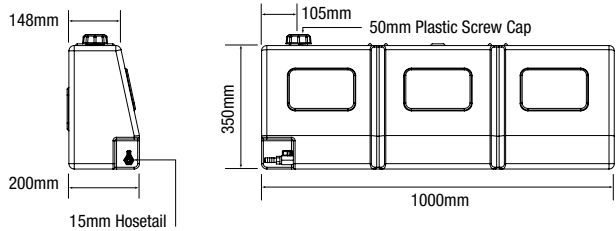

IWT007 - 60L TANK

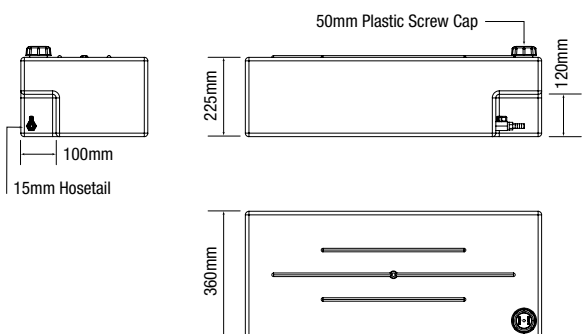

IWT008 - 15L UNDER TRAY HAND WASH TANK

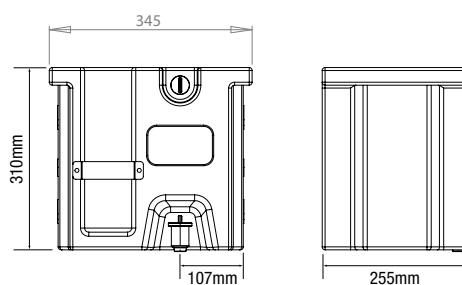

Quick Reference Index

Product Codes

| Part Number | Page |
|-------------|--|
| 98 | 370 |
| 99 | 370 |
| 344 | 337 |
| 345 | 337 |
| 346 | 337, 339 |
| 347 | 337 |
| 351 | 327, 331, 332, 333, 334, 335, 336, 338 |
| 354 | 327, 331 |
| 384 | 291, 292 |
| 385 | 268, 291, 292 |
| 386 | 268, 291, 292 |
| 470 | 234, 235 |
| 635 | 370 |
| 664 | 234, 235 |
| 665 | 234 |
| 667 | 227, 229 |
| 791 | 73, 74, 93, 113, 114 |
| 792 | 73, 74, 93, 113, 114 |
| 794 | 66, 157 |
| 795 | 171, 173, 176, 189, 191, 193, 194, 195 |
| 796 | 171, 173, 176, 195 |
| 797 | 207, 208 |
| 798 | 207, 208, 209 |
| 1141 | 310, 313, 317, 321, 325, 330 |
| 1142 | 310, 313, 317, 321, 325, 330 |
| 1144 | 301, 306, 309, 312, 316, 320, 324, 330 |
| 1147 | 54, 58, 62, 95, 152 |
| 1148 | 81, 84, 102, 105, 143 |
| 1149 | 144 |
| 1150 | 353 |
| 1155 | 280, 284 |
| 1156 | 99, 148 |
| 1189 | 356, 357 |
| 1199 | 47, 181, 185 |
| 3501 | 220 |
| 3502 | 140 |
| 3511 | 137, 141, 220, 224, 227 |
| 3517 | 170, 171, 172, 173, 193, 194, 195 |
| 3521 | 291, 292 |
| 3522 | 229, 234, 235, 336, 337, 338, 339 |
| 3524 | 301, 306, 309, 320, 327, 328, 329, 331, 332, 334 |

| Part Number | Page |
|-------------|---|
| 3525 | 309, 312, 316, 320, 324, 330 |
| 3530 | 259 |
| 3532 | 134, 135, 136 |
| 3533 | 267, 268, 290 |
| 3534 | 230, 232 |
| 3536 | 230, 232 |
| 3540 | 117, 123, 127, 128 |
| 3541 | 127 |
| 3542 | 255 |
| 3543 | 119, 125 |
| 3544 | 119, 125 |
| 1002K | 227, 230, 232 |
| 1084UK | 317, 321 |
| 1085UK | 310, 313, 325 |
| 1100UBK | 227 |
| 1100UBKL | 227 |
| 1102UBK | 189, 191 |
| 1103UBK | 144 |
| 1104UBK | 199, 202 |
| 1105UBK | 246 |
| 1106UBK | 276 |
| 1107UBK | 95 |
| 1141-1 | 325, 330 |
| 1144R | 428 |
| 1144RK | 220, 224, 227, 230, 232, 301, 306, 309, 312, 316, 320, 324, 330 |
| 1144SK | 220, 224, 227, 230, 232, 301, 306, 309, 312, 316, 320, 324, 330 |
| 1145SK | 134, 135, 136, 137, 141 |
| 1146RK | 255, 257, 258 |
| 1147 | 51 |
| 1151UK | 289 |
| 1152K | 99, 102, 105, 148 |
| 1153UK | 246 |
| 1154UK | 276 |
| 1185UK | 330 |
| 1188UK | 356, 357 |
| 1190UK | 359, 361 |
| 1191UK | 351 |
| 1192K | 273, 275, 280, 284, 351 |
| 1193UK | 51, 54, 58, 62, 152 |
| 1194K | 54, 58, 62, 152 |
| 1195UK | 95 |
| 1196UK | 353 |
| 1197K | 353 |
| 1198K | 265, 271, 275, 287, 341, 344, 346, 351 |
| 1200UK | 47, 181, 185 |

| Part Number | Page |
|-------------|--|
| 1201K | 47, 181, 185 |
| 1202K | 121 |
| 1203K | 58, 62, 152 |
| 1204K | 161, 198 |
| 1205K | 47, 181, 185 |
| 12075GR | 234, 235 |
| 12076GR | 234, 235 |
| 1207K | 143 |
| 12080GR | 134, 135, 136, 137, 141 |
| 12081GR | 280, 284, 287, 290, 327, 330 |
| 12081GRC | 280, 284, 287, 290, 327, 330 |
| 12082GR | 172, 173, 194, 195 |
| 12083GR | 262, 263 |
| 12085GR | 259 |
| 12086GR | 259 |
| 12087GR | 73, 74, 93, 97, 113, 114, 144, 145, 170, 171, 175, 176, 193, 208 |
| 12088GR | 267, 268, 290 |
| 12089GR | 262, 263 |
| 1208K | 143 |
| 12091GR | 220, 224, 227, 230, 232, 309, 312, 316, 320, 324, 329, 330 |
| 12094GR | 221, 225, 230, 232, 309, 313, 317, 321, 325 |
| 12094GRC | 309, 313, 317, 321, 325 |
| 12095GR | 54, 58, 62, 65, 66, 95, 152, 155, 157 |
| 12095GRC | 54, 58, 62, 65, 66, 95, 152, 155, 157 |
| 1209K | 265, 271, 341, 344 |
| 1210K | 273, 280, 284 |
| 1211K | 255 |
| 1213K | 280, 284 |
| 1214K | 54, 68 |
| 1215K | 250, 252, 253 |
| 1216K | 250, 253 |
| 1217K | 95, 353 |
| 1218ADK | 265, 341, 344, 347 |
| 1218R | 271, 341, 344, 347 |
| 1219R | 255 |
| 1220K | 265, 341, 344, 347 |
| 1223K | 51 |
| 1235K | 125 |
| 1236K | 125 |
| 12635GR | 336, 337, 338, 339 |
| 12635GRC | 336, 337, 338, 339 |

| Part Number | Page |
|-------------|--|
| 12636GR | 74, 81, 84, 86, 88, 90, 92, 93, 102, 105, 107, 109, 114, 143, 171, 173, 176, 189, 191, 194, 195, 207, 208, 215, 292, 335, 336, 337, 338, 339 |
| 12636GRC | 74, 81, 84, 86, 88, 90, 92, 93, 102, 105, 107, 109, 114, 143, 171, 173, 176, 189, 191, 194, 195, 207, 208, 215, 292, 335, 336, 337, 338, 339 |
| 12636GRP | 81, 84, 86, 88, 90, 92, 93, 102, 105, 107, 109, 114, 143, 171, 173, 176, 189, 191, 194, 195, 207, 208, 215, 292, 335, 336, 337, 338, 339 |
| 12637GR | 97, 267, 327, 331, 332, 334 |
| 12637GRC | 97, 267, 327, 331, 332, 334 |
| 12637GRS | 357 |
| 12639GR | 291, 292 |
| 12639GRC | 291, 292 |
| 12639GRS | 329 |
| 12640GR | 134, 135, 136, 137, 141 |
| 12643GR | 72, 92, 112 |
| 12644GR | 72, 92, 112 |
| 12645GR | 172, 175 |
| 12645GRC | 172, 175 |
| 12645GRS | 163, 165, 174 |
| 12646GR | 170 |
| 12648GR | 227, 229 |
| 12650GR | 129, 268, 287, 289, 291, 329, 331, 333 |
| 12650GRC | 129, 268, 287, 289, 291, 329, 331, 333 |
| 12652GR | 356 |
| 12658GR | 262, 263 |
| 12661GR | 229, 266, 349 |
| 12661GRS | 247 |
| 12665GR | 117, 123, 128 |
| 12666GR | 117 |
| 12667GR | 65, 66, 75, 88, 90, 109, 155, 157, 177, 215, 247, 277 |
| 12669GR | 128 |
| 12670GR | 123 |
| 12671GR | 73, 113, 177 |
| 12682GR | 271, 301, 306 |
| 12682GRC | 265, 271, 341, 344, 347 |
| 12682GRP | 265, 271, 341, 344, 347 |
| 12683GR | 301, 306 |
| 12691GR | 266, 349 |
| 12696GR | 328 |
| 12697GR | 328 |



Product Codes

| Part Number | Page | Part Number | Page | Part Number | Page | Part Number | Page |
|---------------|--|----------------|--------------------|---------------|--|-------------|---|
| 12698GR | 99, 148, 177, 193, 199, 209, 356, 357 | 12755GR | 354 | 12836012GRP | 253 | 24095FEP | 54, 58, 62, 65, 66, 95, 152, 155, 157 |
| 12698GRC | 99, 148, 193, 199, 209 | 12759GR | 255, 257 | 12840080GR LH | 269 | 24635FE | 336, 337, 338, 339 |
| 12698GRP | 99, 148, 193 | 12760GR | 255, 257 | 12840080GR RH | 269 | 24635FEC | 336, 337, 338, 339 |
| 12710GR | 96, 129, 265, 271, 275, 287, 341, 346, 351 | 12764GR LH | 289 | 12842GR | 269 | 24636FE | 74, 81, 84, 86, 88, 90, 92, 93, 102, 105, 107, 109, 114, 143, 171, 173, 176, 189, 191, 194, 195, 208, 215, 292, 335, 336, 337, 338, 339 |
| 12711GR | 115, 116 | 12764GR RH | 289 | 12845GR | 99, 148 | 24636FEC | 74, 81, 84, 86, 88, 90, 92, 93, 102, 105, 107, 109, 114, 143, 171, 173, 176, 189, 191, 194, 195, 208, 215, 292, 335, 336, 337, 338, 339 |
| 12712GR | 115, 116 | 12765GR | 355 | 12851GR | 119, 125 | 24637FE | 267, 327, 331, 332, 334 |
| 12713GR | 168 | 12774GR | 122 | 12851GRC | 119, 125 | 24637FEC | 267, 327, 331, 332, 334 |
| 12714GR | 168 | 12775GR | 122 | 12851LGR | 125 | 24637FES | 357 |
| 12715GR | 46, 163, 165, 174, 180, 184, 188, 191 | 12776GR | 140 | 12851LGRC | 125 | 24639FE | 291, 292 |
| 12716GR | 161, 198, 199, 204, 205, 211, 213, 236 | 12777GR | 140 | 12852LGR | 125 | 24639FES | 329 |
| 12717GR | 204, 205, 236 | 12791GR | 207, 209 | 12852LGRC | 125 | 24640FE | 134, 135, 136, 137, 141 |
| 12718GR | 211, 213 | 12795GR | 304 | 12852GR | 125 | 24643FE | 72, 112 |
| 12720GR | 297, 299 | 12796GR | 297, 299, 304 | 12852GRC | 125 | 24644FE | 72, 75, 112 |
| 12721GR | 261 | 12797GR | 86, 107 | 12853GR | 95 | 24645FE | 172, 175 |
| 12722GR | 261 | 12804GR | 96 | 12885GR | 51 | 24645FEC | 172, 175 |
| 12725GR | 359, 361 | 12805GR | 277 | 12886GR | 51 | 24645FES | 163, 165, 174 |
| 12726GR | 359, 361 | 12805GRC | 277 | 12886GRC | 51 | 24646FE | 170 |
| 12727GR | 58, 62, 70, 152 | 12811GR | 158 | 2244AK | 418, 419, 420 | 24648FE | 227, 229 |
| 12728GR | 161, 198 | 12812GR | 158 | 2244K | 418, 419, 420, 421, 422, 424 | 24650FE | 129, 268, 287, 289, 291, 329, 331, 333 |
| 12729GR | 47, 181, 185 | 12823GR | 244, 245, 246, 249 | 24080FE | 134, 135, 136, 137, 141 | 24650FEC | 129, 268, 287, 289, 291, 331, 333 |
| 12729GRC | 47, 181, 185 | 12824GR | 244 | 24081FE | 280, 284, 287, 290, 327 | 24650FEP | 129, 268, 287, 289, 291, 331, 333 |
| 12729GRP | 47, 181, 185 | 12825GR | 245 | 24081FEC | 280, 284, 287, 290, 327, 330 | 24652FE | 356 |
| 12730GR | 273, 280, 284 | 12826GR | 246 | 24081FEP | 280, 284, 287, 290, 327, 330 | 24661FE | 229, 266, 349 |
| 12731GR | 144 | 12827GR | 54, 68 | 24082FE | 172, 173, 194, 195 | 24661FES | 247 |
| 12732GR | 68, 70 | 12828GR | 249 | 24087FE | 73, 74, 93, 97, 113, 114, 170, 171, 175, 176, 193, 208 | 24665FE | 117, 123, 128 |
| 12735GR | 121 | 12830007GR LH | 250 | 24088FE | 267, 268, 290 | 24666FE | 117 |
| 12738GR LH/RH | 121 | 12830007GR RH | 250 | 24091FE | 220, 224, 227, 230, 232, 309, 312, 316, 320, 324, 329, 330 | 24667FE | 65, 66, 75, 88, 90, 109, 155, 157, 177, 215, 247, 277 |
| 12740GR | 217 | 12830007GRP LH | 250 | 24091FEP | 220, 224, 230, 232 | 24682FE | 271, 301, 306 |
| 12742GR | 217 | 12830007GRP RH | 250 | 24091LFE | 220, 224, 230, 232 | 24682FEC | 265, 271, 341, 344, 347 |
| 12743GR | 273, 275 | 12831009GR LH | 252 | 24091LFE1 | 220, 224, 230, 232 | 24682FEP | 265, 271, 341, 344, 347 |
| 12743GRC | 273, 275 | 12831009GR RH | 252 | 24094FE | 221, 225, 230, 232, 309, 313, 317, 321, 325 | 24682LFE | 301, 306 |
| 12744GR | 351 | 12832008GR | 250 | 24094FEC | 309, 313, 317, 321, 325 | 24682LFE1 | 301, 306 |
| 12745GR | 77, 79, 81, 84, 102, 105, 111, 142 | 12832008GRP | 250 | 24094FEP | 221, 225, 230, 232, 309, 313, 317, 321, 325 | | |
| 12746GR | 77, 79, 111 | 12833009GR LH | 252 | 24094LFE | 221, 225, 230, 232, 309, 313, 317, 321, 325 | | |
| 12746GRC | 77, 79, 111 | 12833009GR RH | 252 | 24094LFE1 | 221, 225, 230, 232 | | |
| 12747GR | 44, 242 | 12833009GRP LH | 252 | 24094LFEC | 309, 313, 317, 321, 325 | | |
| 12748GR | 44, 242 | 12833009GRP RH | 252 | 24094LFEP | 221, 225, 230, 232, 309, 313, 317, 321, 325 | | |
| 12749GR | 144, 145 | 12834010GR | 252 | 24095FE | 54, 58, 62, 65, 66, 95, 152, 155, 157 | | |
| 12750GR | 344 | 12834010GRP | 252 | 24095FEC | 54, 58, 62, 65, 66, 95, 152, 155, 157 | | |
| 12751GR | 127 | 12834014GR | 252 | | | | |
| 12751LGR | 127 | 12834014GRP | 252 | | | | |
| 12752GR | 127 | 12835011GR LH | 253 | | | | |
| 12752LGR | 127 | 12835011GR RH | 253 | | | | |
| | | 12835011GRP LH | 253 | | | | |
| | | 12835011GRP RH | 253 | | | | |
| | | 12836012GR | 253 | | | | |



Product Codes

| Part Number | Page |
|-------------|--|
| 24683FE | 301, 306 |
| 24683LFE | 301, 306 |
| 24683LFE1 | 301, 306 |
| 24691FE | 266, 349 |
| 24696FE | 328 |
| 24697FE | 328 |
| 24698FE | 99, 148, 193, 199, 209, 356, 357 |
| 24698FEC | 99, 148, 193, 199, 209 |
| 24698FEP | 99, 148, 193, 199, 209 |
| 24710FE | 96, 129, 265, 271, 275, 287, 341, 346, 351 |
| 24713FE | 168 |
| 24715FE | 46, 163, 165, 174, 180, 184, 188, 191 |
| 24716FE | 161, 198, 199, 204, 205, 211, 213, 236 |
| 24717FE | 204, 205, 236 |
| 24717FEP | 204, 205, 236 |
| 24718FE | 211, 213 |
| 24720FE | 297, 299 |
| 24727FE | 58, 62, 70, 152 |
| 24728FE | 161, 198 |
| 24728FEP | 161, 198 |
| 24729FE | 47, 181, 185 |
| 24729FEC | 47, 181, 185 |
| 24729FEP | 47, 181, 185 |
| 24730FE | 273, 280, 284 |
| 24732FE | 68, 70 |
| 24740FE | 217 |
| 24742FE | 217 |
| 24743FE | 273, 275 |
| 24743FEC | 273, 275 |
| 24744FE | 351 |
| 24745FE | 77, 79, 81, 84, 102, 105, 111, 142 |
| 24746FE | 77, 79, 111 |
| 24746FEC | 77, 79, 111 |
| 24750FE | 344 |
| 24776FE | 140 |
| 24777FE | 140 |
| 24780FE | 353 |
| 24781FE | 353 |
| 24788FE | 159 |
| 24789FE | 159 |
| 24795FE | 304 |

| Part Number | Page |
|-------------|--|
| 24796FE | 297, 299, 304 |
| 24804FE | 96 |
| 24805FE | 277 |
| 24811FE | 158 |
| 24812FE | 158 |
| 24827FE | 54, 68 |
| 24840FE LH | 276 |
| 24840FE RH | 276 |
| 24842FE | 276 |
| 24842FEC | 276 |
| 24845FE | 99, 148 |
| 24853FE | 95 |
| 24883FE | 295 |
| 24884FE | 295 |
| 24885FE | 51 |
| 24886FE | 51 |
| 24886FEC | 51 |
| 343LH | 337, 339 |
| 343RH | 337, 339 |
| 348LH | 327, 331, 332, 334, 336, 338 |
| 348RH | 327, 331, 332, 334, 336, 338 |
| 3521S | 257 |
| 353LH | 144, 227, 229, 327, 331, 333, 335, 336 |
| 353RH | 144, 227, 229, 327, 331, 333, 335, 336 |
| 355K | 235 |
| 386-1 | 65, 66, 155, 157, 290 |
| 386-2 | 86, 88, 90, 82, 107, 109, 268, 291, 292 |
| 386-3 | 129, 287, 289 |
| 387-1 | 47, 51, 54, 58, 62, 81, 84, 88, 90, 92, 95, 99, 102, 105, 109, 129, 143, 148, 152, 181, 185, 189, 191, 193, 194, 280, 284, 287, 289, 290 |
| 415UBK | 66, 92, 157, 277, 289, 330, 331, 333, 335, 336, 337, 338, 339, 359, 361 |
| 416UBK | 236, 310, 313, 317, 321, 325, 327 |
| 416UBKL | 310, 313, 317, 321 |
| 417UBK | 54, 58, 62, 65, 86, 88, 90, 107, 109, 152, 155 |
| 436UBK | 229, 327, 331, 332, 334 |
| 437UBK | 47, 181, 185, 204, 205, 268, 287, 290, 291, 292, 351 |
| 437UBKL | 47, 81, 84, 99, 102, 105, 129, 143, 148, 181, 185, 204, 205, 280, 284, 287, 290 |
| 438UBK | 51, 125 |

| Part Number | Page |
|-------------|--|
| 449UBK | 336 |
| 45080FE | 134, 135, 136, 137, 141 |
| 45081FE | 280, 284, 287, 327, 330 |
| 45081FEC | 280, 284, 287, 327, 330 |
| 45081FEP | 280, 284, 287, 327, 330 |
| 45091FE | 220, 224, 227, 230, 232, 309, 312, 316, 320, 324, 330 |
| 45091FEP | 220, 224, 227, 230, 232, 309, 312, 316, 320, 324, 330 |
| 45091LFE | 220, 224, 230, 232 |
| 45091LFE1 | 220, 224, 230, 232 |
| 45091LFEP | 220, 224, 230, 232 |
| 45094FE | 221, 225, 230, 232, 309, 313, 317, 321, 325 |
| 45094FEC | 309, 313, 317, 321, 325 |
| 45094FEP | 221, 225, 230, 232, 309, 313, 317, 321, 325 |
| 45094LFE | 221, 225, 230, 232, 309, 313, 317, 321, 325 |
| 45094LFE1 | 221, 225, 230, 232 |
| 45094LFEC | 309, 313, 317, 312, 325 |
| 45094LFEP | 221, 225, 230, 232, 309, 313, 317, 321, 325 |
| 45095FE | 54, 58, 62, 65, 66, 95, 152, 155, 157 |
| 45095FEC | 54, 58, 62, 65, 66, 95, 152, 155, 157 |
| 45095FEP | 54, 58, 62, 66, 95, 152, 155, 157 |
| 451UBK | 73, 74, 93, 113, 114, 171, 173, 176, 193, 194, 195, 234, 235 |
| 452UBK | 234, 235 |
| 453UBK | 234, 235 |
| 45635FE | 336, 337, 338, 339 |
| 45636FE | 81, 84, 102, 105, 143, 189, 191, 335, 336, 337, 338, 339 |
| 45636FEC | 81, 84, 102, 105, 143, 189, 191, 335, 336, 337, 338, 339 |
| 45636FEP | 81, 84, 102, 105, 143, 189, 191, 335, 336, 337, 338, 339 |
| 45637FE | 327, 331, 332, 334 |
| 45637FEC | 327, 331, 332, 334 |
| 45640FE | 134, 135, 136, 137, 141 |
| 45648FE | 227, 229 |
| 45650FE | |
| 45650FEC | 129, 287, 331, 333 |
| 45650FEP | 129, 331, 333 |
| 45661FE | 229, 266, 349 |

| Part Number | Page |
|-------------|--|
| 45667FE | 65, 66, 155, 157 |
| 45682FE | 271, 301, 306 |
| 45682FEC | 265, 271, 341, 344, 347 |
| 45682FEP | 265, 271, 341, 344, 347 |
| 45682LFE | 301, 306 |
| 45682LFE1 | 301, 306 |
| 45683FE | 301, 306 |
| 45683LFE | 301, 306 |
| 45683LFE1 | 301, 306 |
| 45691FE | 266, 349 |
| 45698FE | 99, 148, 199, 202 |
| 45698FEC | 99, 148, 199, 202 |
| 45698FEP | 99, 148, 199, 202 |
| 45710FE | 129, 265, 271, 275, 287, 341, 346, 351 |
| 45715FE | 46, 163, 165, 180, 184, 188, 191 |
| 45716FE | 161, 198, 199, 204, 205, 211, 213, 236 |
| 45716LFE | 198, 199, 204, 205, 211, 213, 236 |
| 45717FE | 204, 205, 236 |
| 45717FEP | 204, 205, 236 |
| 45720FE | 297, 299 |
| 45727FE | 58, 62, 70, 152 |
| 45728FE | 161, 198 |
| 45728FEC | 161, 198 |
| 45728FEP | 161, 198 |
| 45729FE | 47, 181, 185 |
| 45729FEC | 47, 181, 185 |
| 45729FEP | 47, 181, 185 |
| 45730FE | 273, 280, 284 |
| 45732FE | 68, 70 |
| 45740FE | 217 |
| 45742FE | 217 |
| 45743FE | 273, 275 |
| 45743FEC | 273, 275 |
| 45744FE | 351 |
| 45745FE | 77, 79, 81, 84, 102, 105, 111, 142 |
| 45746FEC | 77, 79, 111 |
| 45750FE | 344 |
| 45751FE | 127 |
| 45751LFE | 127 |
| 45752FE | 127 |
| 45752LFE | 127 |
| 45780FE | 353 |
| 45781FE | 353 |



Product Codes

| Part Number | Page | Part Number | Page | Part Number | Page | Part Number | Page |
|-------------|------------------------------|-------------|---|------------------|--------------------|-------------|--------------------|
| 45795FE | 304 | 654UBK | 209, 259 | 839RK | 221, 225, 231, 233 | BB060-TL | 358 |
| 45796FE | 297, 299, 304 | 655UBK | 259 | 840RT | 428 | BB061-SL | 110 |
| 45796FEP | 297, 299, 304 | 656R | 418, 420 | 841RT | 428 | BB061-TL | 110 |
| 45802FE | 160 | 656RK | 418, 419, 420, 421, 422 | 843RT | 428 | BB064-SL | 340 |
| 45803FE | 160 | 669UBK | 229 | 844RT | 428 | BB064-TL | 340 |
| 45827FE | 54, 68 | 670UBK | 229 | 845RT | 428 | BB065-SL | 282 |
| 45845FE | 99, 148 | 678UBK | 81, 84, 99, 102, 105, 148, 291, 292, 353, 356, 357 | 846RT | 428 | BB065-TL | 282 |
| 45851FE | 119, 125 | 704TUK | 199, 202 | 847CRK | 302, 307 | BB066-SL | 52, 67 |
| 45851FEC | 119, 125 | 704UK | 207, 208 | 847RK | 302, 307 | BB066-TL | 52, 67 |
| 45851LFE | 125 | 713UK | 337, 339 | 848CRK | 221 | BB067-SL | 178 |
| 45851LFEC | 125 | 714UK | 337 | 848RK | 221 | BB067-TL | 178 |
| 45852FE | 125 | 715STUK | 176 | 848RT | 428 | BB068-SL | 142 |
| 45852FEC | 125 | 715TUK | 171, 189, 191, 193, 194 | ADL001 | 301, 306 | BB068-TL | 142 |
| 45852LFE | 125 | 715UK | 173, 195 | ADL001L | 301, 306 | BB074-SL | 98 |
| 45852LFEC | 125 | 718UK | 229 | ADL003 | 224, 227, 230, 232 | BB074-TL | 98 |
| 45853FE | 95 | 719UK | 144, 227, 229, 327, 331, 332, 333, 334, 335, 336, 338 | ADL005 | 220 | BB076-SL | 278 |
| 45854FE | 119 | 720UK | 327 | ADL070 | 309, 312, 316 | BB076-TL | 278 |
| 45854FEC | 119 | 721UK | 235 | ADL106 | 291, 292 | BB080-SL | 147 |
| 45855FE | 240 | 722UK | 234, 235 | AFPAD001 | 370 | BB080-TL | 147 |
| 45855LFE | 240 | 724UK | 234 | AFPAD002 | 370 | BB081-SL | 272 |
| 45856FE | 240 | 728TUK | 88, 90, 109 | ATRO01 | 301, 306 | BB081-TL | 272 |
| 45856FEC | 240 | 728UK | 86, 92, 93, 107 | ATRO03 | 224, 227, 230, 232 | BBA048 | 200, 241 |
| 45860FE | 238 | 728UKL | 277 | ATRO05 | 220 | BBA050 | 45, 182 |
| 45862FE | 238 | 732UK | 291, 292 | ATRO70 | 309, 312, 316 | BBA051 | 282 |
| 45862FEC | 238 | 733UK | 268, 291, 292 | B9MK | 424 | BBA056-VX | 296 |
| 45883FE | 295 | 734UK | 259 | BB038-SL | 60 | BBA065 | 282 |
| 45884FE | 295 | 747UK | 73, 74, 113, 114 | BB038-TL | 60 | BBC002 | 286 |
| 45884FEP | 295 | 756UK | 66, 157 | BB039-TL | 150 | BBC019E | 308, 311, 315, 323 |
| 45885FE | 51 | 758UK | 290 | BB048-SL | 200, 241 | BBC019SC | 308 |
| 45886FE | 51 | 759UK | 65, 155 | BB048-TL | 200, 241 | BBC031 | 187 |
| 45886FEC | 51 | 762UK | 117 | BB050-SL | 45, 182 | BBC033 | 286 |
| 45886FEP | 51 | 767UK | 129, 280, 284, 287, 289 | BB050-TL | 45, 182 | BBC038 | 60 |
| 45RSS001 | 421, 422 | 769UK | 204, 205, 236 | BB051-SL | 282 | BBC039 | 150 |
| 45RSS002 | 422 | 769UKL | 209 | BB051-TL | 282 | BBC040 | 83 |
| 45RSS003 | 422 | 770UK | 81, 84, 99, 102, 105, 143, 148 | BB053-SL | 272 | BBC041 | 104 |
| 45RSS004 | 421 | 788UBK | 207, 208 | BB053-TL | 272 | BBC047 | 343 |
| 45RSS005 | 422 | 797-1 | 204, 205, 236 | BB054-SL | 56, 69, 150 | BBC048 | 200, 241 |
| 45SK6520 | 421, 422 | 797-2 | 209 | BB054-TL | 56, 69 | BBC050 | 45, 182 |
| 45SK7218 | 422 | 797-3 | 199, 202 | BB056-SL | 296 | BBC051 | 282 |
| 45SK7220 | 421, 422 | 832RT | 428 | BB056-TL | 296 | BBC055 | 52, 56, 67, 69 |
| 45TAR001 | 421, 422 | 833R | 428 | BB057-SL | 76, 80 | BBC057 | 76, 80 |
| 45TAR002 | 421, 422 | 833WT | 220, 224, 227, 230, 232 | BB057-TL | 76, 80 | BBC058 | 101 |
| 512UBK | 117 | 834RT | 428 | BB058-SL | 101 | BBC065 | 278 |
| 632RF | 418, 419, 420, 421, 422, 424 | 836RT | 428 | BB058-TL | 101 | BBC065-NB | 282 |
| 635R | 421 | 839CRK | 221, 225, 231, 233 | BB059-EXCEED KIT | 164 | BBC067 | 178 |
| 635RK | 418, 419, 420, 421 | | | BB059-SL | 164 | BBC074 | 98 |
| | | | | BB059-TL | 164 | BBC080 | 147 |
| | | | | BB060-SL | 358 | | |

Product Codes

| Part Number | Page | Part Number | Page | Part Number | Page | Part Number | Page |
|-------------|----------------|---------------|--------------------|---------------|---------|-------------|-------------------------|
| BBC110 | 50 | BBCD063 | 256 | BBPART031 | 30, 364 | BBR075E | 239 |
| BBCD001 | 290 | BBCD065 | 282 | BBPART046 | 50, 364 | BBR077 | 118, 124 |
| BBCD002 | 286 | BBCD066 | 52, 67 | BBPART052 | 364 | BBR077ST | 118, 124 |
| BBCD003 | 91 | BBCD067 | 178 | BBPART053 | 364 | BBR078 | 264 |
| BBCD004 | 305 | BBCD068 | 142 | BBPART054 | 364 | BBR085E | 238 |
| BBCD005 | 300 | BBCD070 | 254 | BBPARTLOOP001 | 364 | BBR087E | 71 |
| BBCD006 | 303 | BBCD071 | 243, 248 | BBPARTLOOP002 | 364 | BBR090 | 294 |
| BBCD007 | 348 | BBCD074 | 98 | BBPARTLOOP003 | 364 | BBR110 | 50 |
| BBCD008 | 346 | BBCD076 | 278 | BBPARTLOOP004 | 364 | BBS070 | 254 |
| BBCD009 | 219 | BBCD076-NB | 278 | BBPARTLOOP005 | 364 | BBT014 | 64 |
| BBCD010 | 228 | BBCD079 | 162 | BBPARTLOOP007 | 364 | BBT016 | 190 |
| BBCD012 | 203, 210 | BBCD080 | 147 | BBPARTLOOP008 | 364 | BBT024 | 154 |
| BBCD013 | 206 | BBCD081 | 272 | BBPARTLOOP009 | 364 | BBT027 | 87 |
| BBCD014 | 64 | BBCD082 | 197 | BBPARTLOOP010 | 364 | BBT033 | 286 |
| BBCD016 | 190 | BBCD110 | 50 | BBPARTLOOP011 | 364 | BBT034 | 360 |
| BBCD018 | 308, 319, 326 | BBP011 | 218 | BBPARTLOOP012 | 364 | BBT038-NL | 60 |
| BBCD020 | 89, 108 | BBP019E | 308, 311, 315, 323 | BBPARTLOOP013 | 364 | BBT039-NL | 150 |
| BBCD024 | 154 | BBP019SC | 308 | BBPARTLOOP014 | 364 | BBT046 | 260 |
| BBCD027 | 87 | BBP025 | 298 | BBPARTLOOP016 | 364 | BBT048-NL | 200, 241 |
| BBCD029 | 343 | BBP043 | 298 | BBPARTLOOP019 | 364 | BBT049 | 110 |
| BBCD031 | 187 | BBP056-VX | 296 | BBPARTLOOP020 | 364 | BBT050-NL | 45, 182 |
| BBCD033 | 286 | BBP062 | 216 | BBPARTLOOP024 | 364 | BBT051-NL | 282 |
| BBCD034 | 360 | BBP064 | 340 | BBPARTLOOP025 | 364 | BBT053 | 272 |
| BBCD035 | 126 | BBP082 | 197 | BBPARTLOOP027 | 364 | BBT053-NL | 272 |
| BBCD037 | 270 | BBP084 | 216 | BBPARTLOOP029 | 364 | BBT054-NL | 56, 69 |
| BBCD038 | 60 | BBP090 | 294 | BBPARTLOOP031 | 364 | BBT056VX-NL | 296 |
| BBCD039 | 150 | BBP110 | 50 | BBPARTLOOP033 | 364 | BBT057-NL | 76, 80 |
| BBCD040 | 83 | BBPART002 | 30, 364 | BBPARTLOOP034 | 364 | BBT058-NL | 101 |
| BBCD041 | 104 | BBPART006 | 364 | BBPARTLOOP037 | 364 | BBT059-NL | 164 |
| BBCD042 | 203, 210 | BBPART008 | 364 | BBPARTLOOP038 | 364 | BBT060-NL | 358 |
| BBCD044 | 78 | BBPART009 L/H | 364 | BBPARTLOOP039 | 364 | BBT061-NL | 110 |
| BBCD045 | 166, 167 | BBPART009 R/H | 364 | BBPARTLOOP040 | 364 | BBT064-NL | 340 |
| BBCD046 | 260 | BBPART010 | 364 | BBPARTLOOP041 | 364 | BBT065-NL | 282 |
| BBCD047 | 343 | BBPART011 | 364 | BBPARTLOOP042 | 364 | BBT066-NL | 52, 67 |
| BBCD048 | 200, 241 | BBPART012 | 364 | BBPARTLOOP043 | 364 | BBT067-NL | 178 |
| BBCD049 | 110 | BBPART013 | 364 | BBPARTLOOP044 | 364 | BBT068-NL | 142 |
| BBCD050 | 45, 182 | BBPART014 | 364 | BBPARTLOOP045 | 364 | BBT074-NL | 98 |
| BBCD051 | 282 | BBPART015 | 364 | BBPARTLOOP047 | 365 | BBT076-NL | 278 |
| BBCD052 | 120 | BBPART018 | 368 | BBPARTLOOP048 | 365 | BBT079-NL | 162 |
| BBCD053 | 272 | BBPART019 | 364 | BBPARTLOOP049 | 365 | BBT080-NL | 147 |
| BBCD054 | 56, 69 | BBPART020 | 364 | BBPARTLOOP050 | 365 | BBT081-NL | 272 |
| BBCD055 | 52, 56, 67, 69 | BBPART021 | 364 | BBPARTLOOP051 | 365 | BBT082-NL | 197 |
| BBCD057 | 76, 80 | BBPART022-LH | 364 | BBPARTLOOP054 | 365 | BHOSE001 | 301, 306 |
| BBCD058 | 101 | BBPART022-RH | 364 | BBPARTLOOP056 | 365 | BHOSE002 | 301, 302, 306 |
| BBCD059 | 164 | BBPART023 | 364 | BBPARTLOOP057 | 365 | BHOSE003 | 220, 224, 227, 230, 232 |
| BBCD060 | 358 | BBPART024 | 364 | BBPARTLOOP058 | 365 | BHOSE004 | 221, 225, 231, 233 |
| BBCD061 | 110 | BBPART025 | 364 | BBR072 | 350 | BHOSE005 | 220, 224 |
| | | BBPART026 | 364 | BBR073 | 352 | BHOSE009 | 255 |



Product Codes

| Part Number | Page | Part Number | Page | Part Number | Page | Part Number | Page |
|--------------------|---------------------|----------------------|---------------------|----------------|------|----------------|-------------------------|
| BRACKET100 | 304 | CANFIBRESPARE032 | 367 | CANOPYSPARE004 | 365 | CANOPYSPARE054 | 366 |
| CAN001 | 41 | CANFIBRESPARE033 | 367 | CANOPYSPARE005 | 365 | CANOPYSPARE055 | 366 |
| CANFIBRE048-BS | 201, 241 | CANFIBRESPARE034 | 367 | CANOPYSPARE006 | 365 | CANOPYSPARE056 | 366 |
| CANFIBRE048-PW | 201, 241 | CANFIBRESPARE035 | 367 | CANOPYSPARE007 | 365 | CANOPYSPARE057 | 366 |
| CANFIBRE048-SG | 201, 241 | CANFIBRESPARE036 | 367 | CANOPYSPARE008 | 365 | CANOPYSPARE058 | 366 |
| CANFIBRE048-WINDOW | 367 | CANFIBRESPARE037 | 367 | CANOPYSPARE009 | 365 | CANOPYSPARE059 | 366 |
| CANFIBRE048-WP | 201, 241 | CANFIBRESPARE038 | 367 | CANOPYSPARE010 | 365 | CANOPYSPARE060 | 366 |
| CANFIBRE050-BM | 45, 179, 183 | CANFIBRESPARE039 | 367 | CANOPYSPARE012 | 365 | CANOPYSPARE061 | 366 |
| CANFIBRE050-GG | 179 | CANOPY MOUNT KIT 014 | 365 | CANOPYSPARE013 | 365 | CANOPYSPARE062 | 366 |
| CANFIBRE050-IB | 45, 179, 183 | CANOPY MOUNT KIT 015 | 365 | CANOPYSPARE014 | 365 | CANOPYSPARE063 | 366 |
| CANFIBRE050-SS | 45, 179, 183 | CANOPY003-WINDOW | 366 | CANOPYSPARE015 | 365 | CANOPYSPARE064 | 366 |
| CANFIBRE050-TG | 45, 183 | CANOPY004-WINDOW | 366 | CANOPYSPARE016 | 365 | CANOPYSPARE066 | 366 |
| CANFIBRE050-WINDOW | 367 | CANOPY005-WINDOW | 366 | CANOPYSPARE017 | 365 | CANOPYSPARE068 | 366 |
| CANFIBRE050-WS | 45, 179, 183 | CANOPY006-WINDOW | 366 | CANOPYSPARE018 | 365 | CANOPYSPARE069 | 366 |
| CANFIBRE051-AB | 279, 283 | CANOPY007-WINDOW | 366 | CANOPYSPARE019 | 365 | CANOPYSPARE070 | 366 |
| CANFIBRE051-DG | 279, 283 | CANOPY008-WINDOW | 366 | CANOPYSPARE020 | 365 | CANOPYSPARE071 | 366 |
| CANFIBRE051-SM | 279, 283 | CANOPY009-WINDOW | 366 | CANOPYSPARE021 | 365 | CANOPYSPARE072 | 366 |
| CANFIBRE051-SW | 279, 283 | CANOPY010 BRACKET | 49, 53, 57, 61, 151 | CANOPYSPARE022 | 365 | CANOPYSPARE073 | 366 |
| CANFIBRE051-WINDOW | 367 | CANOPY010-CL WINDOW | 366 | CANOPYSPARE023 | 365 | CANOPYSPARE074 | 366 |
| CANFIBRE054-AW | 49, 53, 57, 61 | CANOPY010-M | 53, 57, 61, 151 | CANOPYSPARE024 | 365 | CANOPYSPARE075 | 366 |
| CANFIBRE054-BL | 49, 53, 57, 61 | CANOPY010-P | 53, 57, 61, 151 | CANOPYSPARE025 | 365 | CANOPYSPARE076 | 366 |
| CANFIBRE054-FW | 49, 53, 57, 61, 151 | CANOPY010-WB | 53, 57, 61, 151 | CANOPYSPARE026 | 365 | CANOPYSPARE077 | 366 |
| CANFIBRE054-M | 49, 53, 57, 61, 151 | CANOPY010-WINDOW | 366 | CANOPYSPARE027 | 365 | CANOPYSPARE078 | 366 |
| CANFIBRE054-SB | 49, 53, 57, 61, 151 | CANOPY011-WINDOW | 366 | CANOPYSPARE028 | 365 | CANOPYSPARE079 | 366 |
| CANFIBRE054-WINDOW | 367 | CANOPY012-WINDOW | 366 | CANOPYSPARE029 | 365 | CANOPYSPARE080 | 366 |
| CANFIBRE057-WINDOW | 367 | CANOPY013-CB | 201, 241 | CANOPYSPARE031 | 365 | CANOPYSPARE081 | 366 |
| CANFIBRESPARE006 | 367 | CANOPY013-PW | 201, 241 | CANOPYSPARE032 | 365 | CANOPYSPARE082 | 366 |
| CANFIBRESPARE007 | 367 | CANOPY014-CL WINDOW | 366 | CANOPYSPARE033 | 365 | CANOPYSPARE083 | 366 |
| CANFIBRESPARE010 | 367 | CANOPY014-P | 45, 179, 183 | CANOPYSPARE034 | 365 | CANOPYSPARE084 | 366 |
| CANFIBRESPARE011 | 367 | CANOPY014-WINDOW | 366 | CANOPYSPARE035 | 365 | CANOPYSPARE085 | 366 |
| CANFIBRESPARE012 | 367 | CANOPY015-CL WINDOW | 366 | CANOPYSPARE036 | 365 | CANOPYSPARE086 | 366 |
| CANFIBRESPARE013 | 367 | CANOPY015-WINDOW | 366 | CANOPYSPARE037 | 365 | CANOPYSPARE087 | 366 |
| CANFIBRESPARE014 | 367 | CANOPY017-SW | 283 | CANOPYSPARE038 | 365 | CANOPYSPARE088 | 366 |
| CANFIBRESPARE015 | 367 | CANOPY017-WINDOW | 367 | CANOPYSPARE039 | 365 | CANOPYSPARE089 | 366 |
| CANFIBRESPARE016 | 367 | CANOPY018-B | 151 | CANOPYSPARE040 | 365 | CANOPYSPARE090 | 366 |
| CANFIBRESPARE019 | 367 | CANOPY018-TF | 151 | CANOPYSPARE041 | 365 | CANOPYSPARE091 | 366 |
| CANFIBRESPARE020 | 367 | CANOPY019-CL WINDOW | 367 | CANOPYSPARE042 | 365 | CAP001 | 41 |
| CANFIBRESPARE021 | 367 | CANOPY020-B | 101 | CANOPYSPARE043 | 365 | CAP002 | 41 |
| CANFIBRESPARE022 | 367 | CANOPY020-CB | 101 | CANOPYSPARE044 | 365 | CAP003 | 41 |
| CANFIBRESPARE023 | 367 | CANOPY020-CL WINDOW | 367 | CANOPYSPARE045 | 365 | CB20 | 418, 420 |
| CANFIBRESPARE024 | 367 | CANOPY020-GG | 101 | CANOPYSPARE046 | 365 | CB35 | 419, 422 |
| CANFIBRESPARE025 | 367 | CANOPY020-P | 101, 104 | CANOPYSPARE047 | 366 | CB7 | 418, 419, 420 |
| CANFIBRESPARE026 | 367 | CANOPY021-B | 360 | CANOPYSPARE048 | 366 | CLINER001 | 370 |
| CANFIBRESPARE027 | 367 | CANOPY021-P | 358, 360 | CANOPYSPARE049 | 366 | CPLATE001 | 301, 306 |
| CANFIBRESPARE028 | 367 | CANOPY021-W | 358, 360 | CANOPYSPARE050 | 366 | CPLATE003 | 220, 224, 227, 230, 232 |
| CANFIBRESPARE029 | 367 | CANOPYSPARE001 | 365 | CANOPYSPARE051 | 366 | DB140 | 31 |
| CANFIBRESPARE030 | 367 | CANOPYSPARE002 | 365 | CANOPYSPARE052 | 366 | | |
| CANFIBRESPARE031 | 367 | CANOPYSPARE003 | 365 | CANOPYSPARE053 | 366 | | |

Product Codes

| Part Number | Page | Part Number | Page | Part Number | Page | Part Number | Page |
|---------------|------------------------------|---------------|---------------------|--------------------|---|-------------|---|
| DB270 | 31 | FOR002B | 54, 58, 62, 95, 152 | FOR010DKG | 51 | HOLD004CD/S | 73, 74, 92, 93, 113, 114 |
| DBL00M | 31 | FOR002C | 54, 58, 62, 95, 152 | FOR010DKP | 51 | HOLD004CKF1 | 93 |
| DBOX001 | 301, 306 | FOR003B | 68, 70 | FOR012A | 51 | HOLD004CKG1 | 93 |
| DBOX003 | 220, 224, 227, 230, 232 | FOR003BKF | 70 | FOR012B | 51 | HOLD004CKG2 | 92 |
| DHOSE350 | 97 | FOR003BKF1 | 68 | FOR012C | 51 | HOLD004CN/S | 73, 74, 92, 93, 113, 114 |
| ET104 | 418, 420, 421 | FOR003BKG | 70 | FOR012D | 51 | HOLD005A | 73, 92, 113 |
| ET113 | 418, 420 | FOR003BKG1 | 68 | FOR012XL3 | 51 | HOLD005BKF | 74, 114 |
| ET113-1 | 418, 419, 420, 422 | FOR003BKP | 70 | GWM002AKF | 95 | HOLD005BKG | 74, 114 |
| ET153 | 418, 419, 420, 421 | FOR003BKP1 | 68 | GWM002AKG | 95 | HOLD005CKF | 74, 114 |
| ET153-1 | 418, 419, 420, 421, 422 | FOR003C | 68, 70 | GWM002AKP | 95 | HOLD005CKG | 74, 114 |
| ET153-2 | 418, 420, 421, 422 | FOR003CKF | 70 | GWM002BKF | 95 | HOLD006B | 88, 90, 109 |
| ET153-3 | 419, 420, 422 | FOR003CKF1 | 68 | GWM002BKG | 95 | HOLD006BKF | 88, 90, 109 |
| ET154 | 419, 420, 422 | FOR003CKG | 70 | GWM002BKP | 95 | HOLD006BKG | 88, 90, 109 |
| ET155 | 419, 420, 422 | FOR003CKG1 | 68 | GWM002CKF | 95 | HOLD006C | 88, 90, 109 |
| ET158 | 418, 420 | FOR003CKP | 70 | GWM002CKG | 95 | HOLD006CKF | 88, 90, 109 |
| ET158-1 | 418, 420, 421 | FOR003CKP1 | 68 | GWM002CKP | 95 | HOLD006CKG | 88, 90, 109 |
| ET158-2 | 419, 420, 422 | FOR005A | 54, 68 | HILFR05 | 115, 116, 289, 359, 361 | HOLD006D | 88, 90, 109 |
| ET160 | 419, 420, 422 | FOR005AKF | 55 | | 46, 51, 58, 62, 70, 77, 79, 81, 84, 86, 95, 96, 99, 102, 105, 107, 111, 129, 142, 148, 152, 161, 163, 165, 174, 180, 184, 188, 191, 198, 199, 204, 205, 211, 213, 217, 236, 265, 266, 271, 273, 275, 280, 284, 287, 297, 299, 341, 344, 346, 349, 351 | HOLD006DKF | 88, 90, 109 |
| ET17 | 418, 419, 420, 421, 422, 424 | FOR005AKG | 55 | HILFR05 / HILFR05F | | HOLD006DKG | 88, 90, 109 |
| ET174 | 419, 420 | FOR005AKP | 55 | | | HOLD007BKF | 73, 113 |
| ET175 | 419 | FOR005B | 54 | | | HOLD007BKG | 73, 113 |
| ET176 | 419 | FOR005BKF | 55 | | | HOLD007CKF | 73, 113 |
| ET177 | 419 | FOR005BKFGVM1 | 378 | | | HOLD007CKG | 73, 113 |
| ET17S | 420 | FOR005BKG | 55 | | | HOLD008B | 72, 75, 111, 112, 215 |
| ET34 | 418, 419, 420, 422 | FOR005BKP | 55 | HILFR05F | 54, 68, 295, 353 | HOLD008BKF | 72, 112 |
| ET38 | 418, 419, 420, 421, 422 | FOR005BKPGVM1 | 378 | HILFR10 | 115, 116, 289, 359, 361 | HOLD008BKF1 | 75 |
| ET38-1 | 422 | FOR005C | 54 | | 46, 51, 58, 62, 70, 77, 79, 81, 84, 86, 95, 96, 99, 102, 105, 107, 111, 129, 142, 148, 152, 161, 163, 165, 174, 180, 184, 188, 191, 198, 199, 204, 205, 211, 213, 217, 236, 265, 266, 271, 273, 275, 280, 284, 287, 297, 299, 341, 344, 346, 349, 351 | HOLD008BKG | 72, 112 |
| ET38-2 | 419, 420, 422 | FOR005CKF | 55 | | | HOLD008BKG1 | 75 |
| ET69 | 418, 419, 420, 421 | FOR005CKFGVM1 | 378 | | | HOLD008C | 72, 75, 111, 112 |
| FOR001A | 58, 62, 70, 152 | FOR005CKG | 55 | HILFR10 / HILFR10F | | HOLD008CKF | 72, 112 |
| FOR001AKF | 59, 63, 153 | FOR005CKP | 55 | | | HOLD008CKF1 | 75 |
| FOR001AKG | 59, 63, 153 | FOR005CKPGVM1 | 378 | | | HOLD008CKG | 72, 112 |
| FOR001AKP | 59, 63, 153 | FOR005S | 54, 68 | | | HOLD008CKG1 | 75 |
| FOR001B | 58, 62, 70, 152 | FOR007A | 49 | HILFR10F | 54, 68, 295, 353 | HOLD009 | 72, 75, 112 |
| FOR001BKF | 59, 63, 153 | FOR008A | 49 | HILFR15 | 115, 116, 289, 359, 361 | HOLD010 | 88, 90, 109 |
| FOR001BKFGVM1 | 379 | FOR010A | 51 | | 46, 51, 58, 62, 70, 77, 79, 81, 84, 86, 95, 96, 99, 102, 105, 107, 111, 129, 142, 148, 152, 161, 163, 165, 174, 180, 184, 188, 191, 198, 199, 204, 205, 211, 213, 217, 236, 265, 266, 271, 273, 275, 280, 284, 287, 297, 299, 341, 344, 346, 349, 351 | HOLD020A | 77, 79, 81, 84, 99, 102, 105, 111, 142, 148 |
| FOR001BKG | 59, 63, 153 | FOR010AKF | 51 | | | HOLD020B | 77, 79, 81, 84, 99, 102, 105, 111, 142, 148 |
| FOR001BKP | 59, 63, 153 | FOR010AKG | 51 | HILFR15 / HILFR15F | | HOLD020BKF | 111 |
| FOR001BKPGVM1 | 379 | FOR010AKP | 51 | | | HOLD020BKG | 111 |
| FOR001C | 58, 62, 152 | FOR010B | 51 | | | HOLD020BKP | 111 |
| FOR001CKF | 59, 63, 153 | FOR010BKF | 51 | | | HOLD020C | 77, 79, 84, 99, 105, 111, 148 |
| FOR001CKFGVM1 | 379 | FOR010BKG | 51 | | | HOLD020CKF | 111 |
| FOR001CKG | 59, 63, 153 | FOR010BKP | 51 | HILFR15F | 54, 68, 295, 353 | HOLD020CKG | 111 |
| FOR001CKP | 59, 63, 153 | FOR010C | 51 | HOLD004BD/S | 73, 74, 92, 93, 113, 114 | HOLD020CKP | 111 |
| FOR001CKPGVM1 | 379 | FOR010CKF | 51 | HOLD004BKF1 | 93 | HOLD020S | 77, 79, 84, 99, 105, 111, 148 |
| FOR001S | 58, 62, 70, 152 | FOR010CKG | 51 | HOLD004BKG1 | 93 | | |
| FOR002A | 54, 58, 62, 95, 152 | FOR010CKP | 51 | HOLD004BKG2 | 92 | | |
| | | FOR010DKF | 51 | HOLD004BN/S | 73, 74, 92, 93, 113, 114 | | |



Product Codes

| Part Number | Page | Part Number | Page | Part Number | Page | Part Number | Page |
|-----------------|--------------------------------|-----------------|--------------------------------|-----------------|----------|-------------------|-------------------------|
| HOLD021A | 81, 84, 99, 102, 105, 143, 148 | HOLD021CKP3 | 100, 149 | HYUNDO03B | 97 | IAWNORG012 | 25 |
| HOLD021AKF | 85, 106 | HOLD021CKP3GVM | 381, 383 | HYUNDO03BKG | 97 | IAWN WALL27012 | 25 |
| HOLD021AKF1 | 82, 103 | HOLD021CKP3GVM1 | 381, 383 | HYUNDO04 | 97 | IAWN WALL27023 | 25 |
| HOLD021AKF2 | 143 | HOLD021CKPGVM1 | 380 | IAIRFRESHBOX | 41 | IAWN WALL27034 | 25 |
| HOLD021AKF3 | 100, 149 | HOLD021D | 81, 84, 99, 102, 105, 143, 148 | IAP001 | 204, 205 | IAWN WALL27045 | 25 |
| HOLD021AKG | 85, 106 | HOLD021DKF | 85, 106 | IAPKIT | 31 | IAXE001 | 16 |
| HOLD021AKG1 | 82, 103 | HOLD021DKF1 | 82, 103 | IAREALED001 | 18 | IAXE002 | 16 |
| HOLD021AKG2 | 143 | HOLD021DKF1GVM1 | 382 | IAREATRIPOD | 18 | IBATISO | 39 |
| HOLD021AKG3 | 100, 149 | HOLD021DKF2 | 143 | IAWN270L012 | 24 | IBATTBOX0012 | 19 |
| HOLD021AKP | 85, 106 | HOLD021DKF2GVM1 | 380 | IAWN270L023 | 24 | IBBPL082 | 197 |
| HOLD021AKP1 | 82, 103 | HOLD021DKF3 | 100, 149 | IAWN270L034 | 24 | IBBPL090 | 294 |
| HOLD021AKP2 | 143 | HOLD021DKF3GVM | 381, 383 | IAWN270R012 | 24 | IBBPL110 | 31, 50 |
| HOLD021AKP3 | 100, 149 | HOLD021DKF3GVM1 | 381, 383 | IAWN270R023 | 24 | IBIN0012 | 17 |
| HOLD021B | 81, 84, 99, 102, 105, 143, 148 | HOLD021DKFGVM1 | 380 | IAWN270R034 | 24 | IBLOCK | 11 |
| HOLD021BKF | 85, 106 | HOLD021DKG | 85, 106 | IAWNING1.4M | 26 | IBOOK001 | 41 |
| HOLD021BKF1 | 82, 103 | HOLD021DKG1 | 82, 103 | IAWNING2.5M | 26 | IBOTTLE001 | 41 |
| HOLD021BKF2 | 143 | HOLD021DKG2 | 143 | IAWNING2.5MROOM | 26 | IBOTTLE002 | 41 |
| HOLD021BKF3 | 100, 149 | HOLD021DKG3 | 100, 149 | IAWNING2.5MWALL | 26 | IBOW | 11 |
| HOLD021BKG | 85, 106 | HOLD021DKP | 85, 106 | IAWNING2M | 26 | IBTBAGS | 16 |
| HOLD021BKG1 | 82, 103 | HOLD021DKP1 | 82, 103 | IAWNING2MROOM | 26 | IBTRAY050 | 45, 178, 182 |
| HOLD021BKG2 | 143 | HOLD021DKP1GVM1 | 382 | IAWNING2MWALL | 26 | IBTRAY054 | 49, 50, 52, 56, 60, 150 |
| HOLD021BKG3 | 100, 149 | HOLD021DKP2 | 143 | IAWNINGPART001 | 369 | IBTRAY056 | 296 |
| HOLD021BKP | 85, 106 | HOLD021DKP2GVM1 | 380 | IAWNINGPART002 | 369 | IBTRAY057 | 80 |
| HOLD021BKP1 | 82, 103 | HOLD021DKP3 | 100, 149 | IAWNINGPART003 | 369 | IBTRAY064 | 340, 343 |
| HOLD021BKP2 | 143 | HOLD021DKP3GVM | 381, 383 | IAWNINGPART004 | 369 | IBTRAYTUB | 31 |
| HOLD021BKP3 | 100, 149 | HOLD021DKP3GVM1 | 381, 383 | IAWNINGPART005 | 369 | IBUCKET0012 | 17 |
| HOLD021C | 81, 84, 99, 102, 105, 143, 148 | HOLD021DKPGVM1 | 380 | IAWNINGPART006 | 18, 369 | IBUSHTOILET | 16 |
| HOLD021CKF | 85, 106 | HOLD022A | 77, 79 | IAWNINGPART007 | 369 | ICAMBER12 | 44, 237, 242, 262, 263 |
| HOLD021CKF1 | 82, 103 | HOLD022AKF | 77, 79 | IAWNINGPART008 | 369 | ICAMBER14 | 169, 214, 251, 261 |
| HOLD021CKF1GVM1 | 382 | HOLD022AKG | 77, 79 | IAWNINGPART009 | 26, 369 | ICAMBER17 | 269 |
| HOLD021CKF2 | 143 | HOLD022AKP | 77, 79 | IAWNINGPART010 | 369 | ICANOPY048-WINDOW | 367 |
| HOLD021CKF2GVM1 | 380 | HOLD022B | 77, 79 | IAWNINGQOR | 26 | ICANOPY050-BM | 45, 179, 183 |
| HOLD021CKF3 | 100, 149 | HOLD022BKF | 77, 79 | IAWNINGQOR HOOK | 26 | ICANOPY050-GG | 45, 179, 183 |
| HOLD021CKF3GVM | 381, 383 | HOLD022BKG | 77, 79 | IAWNINGSPARE001 | 368 | ICANOPY050-IB | 45, 179, 183 |
| HOLD021CKF3GVM1 | 381, 383 | HOLD022BKP | 77, 79 | IAWNINGSPARE002 | 368 | ICANOPY050-P | 45, 179, 183 |
| HOLD021CKFGVM1 | 380 | HOLD022BKG | 77, 79 | IAWNINGSPARE003 | 369 | ICANOPY050-SS | 45, 179, 183 |
| HOLD021CKG | 85, 106 | HOLD022C | 77, 79 | IAWNINGSPARE004 | 369 | ICANOPY050-TG | 45, 179, 183 |
| HOLD021CKG1 | 82, 103 | HOLD022CKF | 77, 79 | IAWNINGSPARE005 | 369 | ICANOPY050-WINDOW | 367 |
| HOLD021CKG2 | 143 | HOLD022CKG | 77, 79 | IAWNINGSPARE006 | 369 | ICANOPY050-WS | 45, 179, 183 |
| HOLD021CKG3 | 100, 149 | HOLD022CKP | 77, 79 | IAWNINGSPARE007 | 369 | ICANOPY051-AB | 279, 283 |
| HOLD021CKP | 85, 106 | HOLD022S | 77, 79 | IAWNINGSPARE008 | 369 | ICANOPY051-DG | 279, 283 |
| HOLD021CKP1 | 82, 103 | HOLD022SKF | 77, 79 | IAWNINGSPARE009 | 369 | ICANOPY051-P | 279, 283 |
| HOLD021CKP1GVM1 | 382 | HOLD022SKG | 77, 79 | IAWNINGSPARE010 | 369 | ICANOPY051-SM | 279, 283 |
| HOLD021CKP2 | 143 | HOLD022SKP | 77, 79 | IAWNINGSPARE011 | 369 | ICANOPY051-SW | 279, 283 |
| HOLD021CKP2GVM1 | 380 | HOLD023B | 86, 107 | IAWNINGSPARE012 | 369 | ICANOPY051-WINDOW | 367 |
| | | HOLD023BKG | 86, 107 | IAWNINGSPARE013 | 369 | ICANOPY054-AM | 49, 53, 57, 61, 151 |
| | | HOLD023C | 86, 107 | IAWNINGSPARE014 | 369 | ICANOPY054-AW | 49, 53, 57, 61, 151 |
| | | HOLD023CKG | 86, 107 | IAWNLED270012 | 25 | | |

Product Codes

| Part Number | Page | Part Number | Page | Part Number | Page | Part Number | Page |
|-------------------|---------------------|----------------------|-------------------------------|--------------------|--------------------|-------------|----------|
| ICANOPY054-BL | 49, 53, 57, 61, 151 | ICHAIR0045 | 14 | ICSC074F | 98, 147 | IFF6039I | 151 |
| ICANOPY054-FW | 49, 53, 57, 61, 151 | ICHAIR0056 | 14 | ICSC074R | 98, 147 | IFF6040 | 83 |
| ICANOPY054-G | 49, 53, 57, 61, 151 | ICHAIR0067 | 14 | ICSC082F | 197 | IFF6041 | 104 |
| ICANOPY054-P | 49, 53, 57, 61, 151 | ICOMPRESSOR AIR LINE | 372 | ICSC082R | 197 | IFF6048 | 201 |
| ICANOPY054-SB | 49, 53, 57, 61, 151 | ICOMPRESSOR003 | 12 | ICSCILOAD | 97 | IFF6049 | 110 |
| ICANOPY054-WINDOW | 367 | ICOMPRESSOR004 | 12 | IDBM001 | 31 | IFF6050 | 183 |
| ICANOPY060-P | 358, 360 | ICR003 | 221, 225, 231, 233 | IDCDC40 | 31 | IFF6051 | 283 |
| ICANOPY060-W | 358, 360 | ICSC011F | 218 | IDCDCSA | 31 | IFF6054 | 57 |
| ICANOPY060-WINDOW | 367 | ICSC011F3/4 | 218 | IDCDCSOLAR | 31 | IFF6054XLT | 53 |
| ICANOPY074-B | 98 | ICSC011R | 218 | IDD100 | 304 | IFF6057 | 57 |
| ICANOPY074-GG | 98 | ICSC019F | 308, 311, 315, 323 | IDL0701C | 27 | IFF6058 | 101 |
| ICANOPY074-OG | 98 | ICSC019F3/4 | 308, 311, 315 | IDL0701S | 27 | IFF6066WT | 53 |
| ICANOPY074-P | 98, 147 | ICSC019R | 311, 323 | IDL070COVERS | 29 | IFF6067 | 179 |
| ICANOPY074-S | 98 | ICSC019SCF | 308 | IDL0901C | 27 | IFF6074 | 98 |
| ICANOPY074-W | 98 | ICSC031F | 187, 190 | IDL0901S | 27 | IFF6076 | 279 |
| ICANOPY074-WINDOW | 367 | ICSC031R | 187, 190 | IDL090COVERS | 29 | IFF6080 | 147 |
| ICANOPY082-B | 197 | ICSC033F | 286 | | | IFF6082 | 197 |
| ICANOPY082-BS | 197 | ICSC033R | 286 | | | IFFEXT110 | 50 |
| ICANOPY082-P | 197 | ICSC038F | 61, 151 | | | IFFEXT110R | 50 |
| ICANOPY082-SG | 197 | ICSC038R | 61, 151 | | | IFR0047 | 36 |
| ICANOPY082-SW | 197 | ICSC040F | 76, 78, 80, 83, 101, 104, 110 | | | IFR0048 | 36 |
| ICANOPY082-TG | 197 | ICSC040R | 80, 83, 101, 104 | | | IFR0055 | 36 |
| ICANOPY082-WINDOW | 367 | ICSC042F | 203 | | | IFR0055WT | 36 |
| ICANOPY082-WP | 197 | ICSC042R | 203 | | | IFR0056 | 36 |
| ICANOPY110-AW | 50 | ICSC043F | 296, 298 | | | IFR0056L | 36 |
| ICANOPY110-G | 50 | ICSC043R | 296, 298 | | | IFR0062L | 36 |
| ICANOPY110-P | 50 | ICSC047F | 340, 343 | | | IFR0064 | 36 |
| ICANOPY110-SB | 50 | ICSC047R | 340, 343 | IDISH0012 | 17 | IFR0065 | 36 |
| ICANOPYSPARE001 | 367 | ICSC048F | 201 | IDLWL001 | 31 | IFR0067 | 36 |
| ICANOPYSPARE002 | 367 | ICSC048MYR | 201 | IDLWL002 | 31 | IFR0143 | 36 |
| ICANOPYSPARE003 | 367 | ICSC048R | 201 | IDM009 | 255 | IFR0144 | 36 |
| ICANOPYSPARE004 | 367 | ICSC049R | 76, 78, 110 | IDOC003 | 221, 225, 231, 233 | IFR019C2K | 311 |
| ICANOPYSPARE005 | 367 | ICSC050F | 179, 183 | IDRAG | 11 | IFR019PSK | 311 |
| ICANOPYSPARE006 | 367 | ICSC050R | 179, 183 | IDRINKWARE0012 | 17 | IFR0304 | 36 |
| ICANOPYSPARE007 | 367 | ICSC051F | 279, 283 | IDRINKWARE0023 | 17 | IFR0311 | 36 |
| ICANOPYSPARE008 | 367 | ICSC051R | 279, 283 | IDRINKWARE0034 | 17 | IFR0316 | 36 |
| ICANOPYSPARE009 | 367 | ICSC053F | 272 | IDUFBAG001 | 35 | IFR0321 | 36 |
| ICANOPYSPARE010 | 367 | ICSC053R | 272 | IEBC001 | 31 | IFR0328 | 36 |
| ICANOPYSPARE011 | 367 | ICSC054F | 53, 57, 67, 69, 151 | IENSUITE | 26 | IFR0330 | 36 |
| ICANOPYSPARE013 | 368 | ICSC054R | 67, 69 | IFIRE EXTINGUISHER | 39 | IFR0350 | 36 |
| ICANOPYSPARE014 | 368 | ICSC055R | 49, 53, 57, 151 | IFIREPIT0012 | 17 | IFR0351 | 36 |
| ICANOPYSPARE015 | 368 | ICSC059F | 162, 164 | IFIREPIT0023 | 17 | IFR0360 | 36 |
| ICANOPYSPARE016 | 368 | ICSC059R | 162, 164 | IFF6002 | 286 | IFR0362 | 36 |
| ICANOPYSPARE020 | 368 | ICSC060F | 358, 360 | IFF60110WT | 50 | IFR0516 | 36 |
| ICANOPYSPARE021 | 368 | ICSC060R | 358, 360 | IFF60110XL | 50 | IFR0517 | 36 |
| ICHAIR0012 | 14 | ICSC069F | 49 | IFF6033 | 286 | IFR0518 | 36 |
| ICHAIR0034 | 14 | ICSC070F | 254 | IFF6038 | 61 | IFR0519 | 36 |
| | | ICSC070R | 254 | IFF6039 | 151 | IFR047C3K | 340, 343 |



Product Codes

| Part Number | Page |
|----------------|-------------------------|
| IFR047PEK | 340, 343 |
| IFR048PBK | 197 |
| IFR048C2K | 197 |
| IFR054C2K | 49, 50, 53, 57, 61, 151 |
| IFR054PAK | 49, 50, 53, 57, 61, 151 |
| IFR054WTPAK | 53, 57, 61 |
| IFR056C3K | 296, 298 |
| IFR056PAK | 296, 298 |
| IFR056PEK | 296, 298 |
| IFR062LPNK | 216 |
| IFR065C2K | 279, 283 |
| IFR065PAK | 279, 283 |
| IFR067C2K | 179, 183 |
| IFR067PAK | 179, 183 |
| IFR070C2K | 254 |
| IFR074C2K | 98, 147 |
| IFR074PAK | 98, 147 |
| IFR077C2K | 118 |
| IFR090PAK | 294 |
| IFR090PEK | 294 |
| IFR1007 | 36 |
| IFR1034 | 36 |
| IFR3204 | 37 |
| IFR5022 | 37 |
| IFR5025 | 37 |
| IFR5029 | 37 |
| IFR5031 | 37 |
| IFR5032 | 37 |
| IFR5033 | 37 |
| IFR5034 | 37 |
| IFR5036 | 37 |
| IFR5038 | 37 |
| IFR9337 | 36 |
| IFR9338 | 36 |
| IFR9341 | 36 |
| IFR9347 | 36 |
| IFR9373 | 36 |
| IFR9378 | 36 |
| IFRBOTT | 37 |
| IFRLIGHBKT | 37 |
| IFRIDGE STRAPS | 21 |
| IFRIDGE30 | 20 |
| IFRIDGE30 BAG | 21 |
| IFRIDGE40 | 20 |
| IFRIDGE40 BAG | 21 |
| IFRIDGE43LM | 20 |
| IFRIDGE50 | 20 |
| IFRIDGE50 BAG | 21 |

| Part Number | Page |
|-----------------|--|
| IFRIDGE65LDZM | 20 |
| IFRIDGE70LM | 20 |
| IFRIDGESLIDE001 | 21, 32 |
| IFRIDGESLIDE002 | 21, 32 |
| IFRIDGESLIDE023 | 21, 32 |
| IFRIDGESLIDE045 | 21, 32 |
| IFRIDGESPAE001 | 368 |
| IFRIDGESPAE002 | 368 |
| IFRIDGESPAE003 | 368 |
| IFRIDGESPAE004 | 368 |
| IFRIDGESPAE005 | 368 |
| IFRIDGESPAE006 | 368 |
| IFRIDGESPAE007 | 368 |
| IFRIDGESPAE008 | 368 |
| IFRIDGESPAE009 | 368 |
| IFRIDGESPAE010 | 368 |
| IFRIDGESPAE011 | 368 |
| IFRIDGESPAE012 | 368 |
| IFRIDGESPAE013 | 368 |
| IFRIDGESPAE014 | 368 |
| IFRIDGESPAE015 | 368 |
| IFRIDGESPAE016 | 368 |
| IFRIDGESPAE017 | 368 |
| IFRIDGESPAE018 | 368 |
| IFRIDGESPAE019 | 368 |
| IFRIDGESPAE020 | 368 |
| IFRIDGESPAE021 | 368 |
| IFRIDGESPAE022 | 368 |
| IFRIDGESPAE023 | 368 |
| IFRIDGESPAE024 | 368 |
| IFRIDGESPAE025 | 368 |
| IFRIDGESPAE026 | 368 |
| IFRIDGESPAE027 | 368 |
| IFRIDGESPAE028 | 368 |
| IFRP2C125K | 45, 49, 50, 53, 57, 61, 98, 147, 151, 179, 183, 197, 200, 279, 283, 358, 360 |
| IFRP2C137K | 45, 50, 53, 57, 61, 98, 147, 151, 179, 183, 197, 200, 279, 283, 358, 360 |
| IFRP2PAK | 45, 50, 53, 57, 61, 98, 147, 151, 179, 183, 197, 200, 279, 283, 358, 360 |
| IFRP2PKK | 45, 49, 50, 53, 57, 61, 98, 147, 151, 179, 183, 197, 200, 279, 283, 358, 360 |
| IFRRATC | 37 |
| IFRROLL | 37 |
| IFRSLDAWAY | 36 |

| Part Number | Page |
|----------------|---|
| IFRSLDAWAYC2K | 45, 48, 49, 50, 53, 57, 61, 71, 94, 98, 118, 142, 147, 151, 179, 183, 197, 200, 238, 239, 243, 279, 283, 350, 352, 358, 360 |
| IFRSLDAWAYPSK | 45, 48, 49, 50, 53, 57, 61, 71, 94, 98, 118, 142, 147, 151, 179, 183, 197, 200, 238, 239, 243, 279, 283, 350, 352, 358, 360 |
| IGLOVES | 11 |
| IHCLEAN | 17 |
| IHCLEANBOX | 17 |
| IHEADLAMP002 | 18 |
| IHIDBULB | 368 |
| IHIGHLIFT001 | 12 |
| IHIGHLIFT002 | 12 |
| IHIGHLIFT003 | 12 |
| IHOOK BOW | 11 |
| IHVFLAG | 13, 39 |
| IKETTLE001 | 17 |
| ILANTERN002 | 18 |
| ILANTERN004 | 18 |
| ILBCK049 | 29 |
| ILBCK061 | 29 |
| ILBDR001B | 28 |
| ILBDR001BM | 28 |
| ILBDR002B | 28, 71, 238, 239, 350, 352 |
| ILBDR002BM | 28, 350, 352 |
| ILBDR003B | 28 |
| ILBDRSPAREBKTS | 368 |
| ILBSR000B | 28 |
| ILBSR001 | 29 |
| ILBSR001B | 28 |
| ILBSR001BW | 28 |
| ILBSR001C | 29 |
| ILBSR002 | 29 |
| ILBSR002B | 28 |
| ILBSR002BW | 28 |
| ILBSR002C | 29 |
| ILBSR003 | 29 |
| ILBSR003B | 28, 118, 124 |
| ILBSR003BW | 28, 264 |
| ILBSR003C | 29 |
| ILBSR004 | 29 |
| ILBSR005B | 28 |
| ILBSRSPAREBKTS | 368 |
| ILBSRWSAREBKTS | 368 |
| ILBWL001 | 31 |
| ILC7AMBER | 29 |

| Part Number | Page |
|-----------------|---|
| ILC7BLACK | 29 |
| ILC7BLUE | 29 |
| ILC7CLEAR | 29 |
| ILC9AMBER | 29 |
| ILC9BLACK | 29 |
| ILC9BLUE | 29 |
| ILC9CLEAR | 29 |
| ILCB7AMBER | 29 |
| ILCB7BLACK | 29 |
| ILCB7BLUE | 29 |
| ILCB7CLEAR | 29 |
| ILED180F | 29 |
| ILED180S | 29 |
| ILED20B | 30, 71, 118, 124, 238, 239, 264, 350, 352 |
| ILED20BA | 30, 71, 118, 124, 238, 239, 264, 350, 352 |
| ILED20BF | 30, 71, 118, 124, 238, 239, 264, 350, 352 |
| ILED20BFA | 30, 71, 118, 124, 238, 239, 264, 350, 352 |
| ILED20BFR | 30, 71, 118, 124, 238, 239, 264, 350, 352 |
| ILED20SPAREBKTS | 368 |
| ILED5X7 | 27 |
| ILED7C | 27 |
| ILED7M | 27 |
| ILED80B | 30, 71, 118, 124, 238, 239, 294, 350, 352 |
| ILED80BA | 30, 71, 118, 124, 238, 239, 294, 350, 352 |
| ILED80BF | 30, 71, 118, 124, 238, 239, 294, 350, 352 |
| ILED80BFA | 30, 71, 118, 124, 238, 239, 294, 350, 352 |
| ILED80SPAREBKTS | 368 |
| ILED9C | 27 |
| ILED9M | 27 |
| ILEDBLAST2C | 27 |
| ILEDBLAST2MOUNT | 368 |
| ILEDBLAST2S | 27 |
| ILEDBLASTMOUNT | 368 |
| ILEDCOMETMOUNT | 368 |
| ILEDCOSMO | 30 |
| ILEDDIMMER | 18 |
| ILEDSB | 30 |
| ILEDSTRIP | 18 |

Product Codes

| Part Number | Page |
|----------------|-------------------|
| ILEDUNI3 | 30 |
| ILEDUNI5 | 30 |
| ILEDWL10 | 30, 350, 352 |
| ILEDWL10FA | 30, 350, 352 |
| ILEDWLC | 18 |
| IMALLET | 16 |
| IMAZ001B | 356, 357 |
| IMAZ001BKF | 356 |
| IMAZ001BKF1 | 357 |
| IMAZ001BKG | 356 |
| IMAZ001BKG1 | 357 |
| IMAZ002B | 356, 357 |
| IMC001 | 34 |
| IMC002 | 34 |
| IMC003 | 34 |
| IMC004 | 34 |
| IMC005 | 34 |
| IMC006 | 34 |
| IMTS001M2XL | 40 |
| IMTS001M3XL | 40 |
| IMTS001M5XL | 40 |
| IMTS001ML | 40 |
| IMTS001MM | 40 |
| IMTS001MS | 40 |
| IMTS001MXL | 40 |
| IMTS001WL | 40 |
| IMTS001WM | 40 |
| IMTS001WS | 40 |
| IMTS001WXL | 40 |
| IMTS002M2XL | 40 |
| IMTS002M3XL | 40 |
| IMTS002M5XL | 40 |
| IMTS002ML | 40 |
| IMTS002MM | 40 |
| IMTS002MS | 40 |
| IMTS002MXL | 40 |
| INUMBPLATESLIM | 41 |
| IOVEN0012 | 17 |
| IPET0023 | 14 |
| IPL048 | 31, 200 |
| IPL050 | 31, 182 |
| IPL056 | 31, 296 |
| IPL057 | 31, 76, 80, 83 |
| IPL058 | 31, 101, 104, 110 |
| IPL059 | 164 |
| IPL060 | 31, 358, 360 |
| IPL065 | 278 |

| Part Number | Page |
|-------------------|------------------------|
| IPL066 | 31, 52, 56, 60, 67, 69 |
| IPL067 | 31, 178 |
| IPL070 | 31, 254 |
| IPL074 | 98, 147 |
| IPL077 | 31, 118, 124 |
| IPL084 | 216 |
| IPL110 | 31, 50 |
| IPOWER0012 | 19 |
| IPOWER0023 | 19 |
| IPOWER0034 | 19 |
| IQFS001 | 15 |
| IQFSTEP | 15 |
| IRATCHET0012 | 37 |
| IRATCHET0023 | 37 |
| IRATCHET034 | 37 |
| IRECBRDBASE | 13 |
| IRECBRDGREEN | 13 |
| IRECBRDGREY | 13 |
| IRECBRDLEASH | 13 |
| IRECBRDPINS115 | 13 |
| IRECBRDSAND | 13 |
| IRECKIT001 BAG | 11 |
| IRECKIT002 BAG | 11 |
| IRECKIT003 | 10 |
| IRECKIT004 | 10 |
| IREVERSECAM001 | 39 |
| IRL120B | 30 |
| IRLB200 | 35 |
| IRLB250 | 35 |
| IRLB350 | 35 |
| IRLB500 | 35 |
| IRLB600 | 35 |
| IROOFTENT ANNEX | 22 |
| IROOFTENT TENT | 22 |
| IROOFTENT002 | 22 |
| IROOFTENT003 | 22 |
| IROOFTENTSPARE001 | 369 |
| IROOFTENTSPARE002 | 369 |
| IROOFTENTSPARE003 | 369 |
| IROOFTENTSPARE004 | 369 |
| IROOFTENTSPARE005 | 369 |
| IROOFTENTSPARE006 | 369 |
| IROOFTENTSPARE007 | 369 |
| IROOFTENTSPARE008 | 369 |
| IROOFTENTSPARE010 | 369 |
| IROOFTENTSPARE011 | 369 |
| IROOFTENTSPARE012 | 369 |

| Part Number | Page |
|-------------------|---|
| IROOFTENTSPARE013 | 369 |
| IROOFTENTSPARE014 | 369 |
| IROOFTENTSPARE015 | 369 |
| IROOFTENTSPARE016 | 369 |
| IROOFTENTSPARE017 | 369 |
| IROOFTENTSPARE018 | 369 |
| IROOFTENTSPARE019 | 369 |
| IROOFTENTSPARE020 | 369 |
| IRP005 | 197, 200, 203, 218, 219, 300, 303, 305 |
| IRP019 | 308, 311, 315, 323 |
| IRP019SC | 308 |
| IRP033 | 286 |
| IRP050 | 45, 182 |
| IRP051 | 272, 278, 282 |
| IRP054 | 52, 56, 60, 67, 69, 150 |
| IRP056 | 296, 298 |
| IRP057 | 76, 80 |
| IRP058 | 76, 78, 80, 83, 101, 104, 110 |
| IRP059 | 162, 164, 178 |
| IRP064 | 340, 343 |
| IRP070 | 254 |
| IRP074 | 98, 110 |
| IRP090 | 294 |
| IRRCAGE14 | 38, 133, 218, 219, 228, 305, 311, 315, 319, 323, 332 |
| IRRCAGE14-ALLOY | 38, 133, 218, 219, 228, 254, 305, 311, 315, 319, 323, 332 |
| IRRCAGE18 | 38, 76, 78, 110, 133, 218, 219, 228, 296, 298, 300, 303, 305, 311, 315, 319, 323, 332, 340, 343, 346, 348 |
| IRRCAGE18-ALLOY | 38, 76, 78, 110, 133, 218, 219, 228, 296, 298, 300, 303, 305, 311, 315, 319, 323, 332, 340, 343, 346, 348 |
| IRRCAGE22 | 38, 133, 218, 219, 228, 298, 305, 315, 319, 323, 332 |
| IRRCAGE22-ALLOY | 38, 133, 218, 219, 228, 298, 305, 315, 319, 323, 332 |
| IRRCROSSBAR001 | 38, 368 |
| IRREXT1085 | 38 |
| IRRFEET001 | 38, 76, 78 |
| IRRFEET100 | 38, 218, 219, 254 |
| IRRFEET125 | 38, 218, 219, 228, 305, 311, 323, 332, 348 |
| IRRFEET150 | 38 |
| IRRFEET210 | 38, 133, 228, 315, 319 |
| IRRFEETABS14 | 38, 53, 57, 61, 80, 101, 104, 151, 179, 183, 200, 283 |

| Part Number | Page |
|------------------|---|
| IRRFEETLC100 | 38, 300, 303 |
| IRRFEETLC200 | 38, 296, 298, 346 |
| IRRFEETMUX | 38, 110 |
| IRRFEETPRADO150 | 38, 340, 343 |
| IRROPEN14-ALLOY | 38, 133, 218, 219, 228, 254, 311, 315, 319, 332 |
| IRRTENT18 | 38, 76, 78, 110, 133, 218, 219, 228, 296, 298, 300, 303, 305, 311, 315, 319, 323, 332, 340, 343, 346, 348 |
| IRRTENT22 | 38, 133, 218, 219, 228, 298, 305, 315, 319, 323, 332 |
| IRRTFLAT18-ALLOY | 38, 76, 78, 110, 133, 218, 219, 228, 296, 298, 300, 303, 305, 311, 315, 319, 323, 332, 340, 343, 346, 348 |
| IRRTRADE18 | 38, 76, 78, 110, 133, 218, 219, 228, 296, 298, 300, 303, 305, 311, 315, 319, 323, 332, 340, 343, 346, 348 |
| IRRTRADE18-ALLOY | 38, 76, 78, 110, 133, 218, 219, 228, 296, 298, 300, 303, 305, 311, 315, 319, 323, 332, 340, 343, 346, 348 |
| IRRTRADE22 | 38, 133, 218, 219, 228, 298, 305, 315, 319, 323, 332 |
| IRRTRADE22-ALLOY | 38, 133, 218, 219, 228, 298, 305, 315, 319, 323, 332 |
| IRRWHEELCLAMP | 38, 368 |
| IRTT0012 | 22 |
| IRTT0023 | 22 |
| IRTTAWN0023 | 22 |
| IRWB001 | 13 |
| ISAFETYTRI | 39 |
| ISB200F | 297, 299 |
| ISB200R | 297, 299 |
| ISB600F | 217 |
| ISB600R | 217 |
| ISB789F | 309, 316, 320 |
| ISB789FW | 309, 312, 316, 320, 324 |
| ISB789FWP | 309, 312, 316, 320, 324 |
| ISB789RW | 310, 313, 317, 321, 325 |
| ISB80F | 280, 284 |
| ISBB20033R | 370 |
| ISBB20038R | 370 |
| ISBB200REB | 370 |
| ISBB60027R | 370 |
| ISBB60036R | 370 |
| ISBB78930R | 370 |
| ISBB78933R | 370 |
| ISBB789DB | 370 |
| ISBB789PBK | 370 |



Product Codes

| Part Number | Page | Part Number | Page | Part Number | Page | Part Number | Page |
|-------------------|---|-------------------|--------------------|------------------|---|-------------|--|
| ISBB789REB | 370 | ISLIDEAWAY087S-E | 71 | ISNORKEL053 | 272 | ITBL038 | 60 |
| ISBB8033R | 370 | ISLIDEAWAY110-E | 50 | ISNORKEL056 | 296 | ITBL039 | 60, 150 |
| ISD1000 | 32, 133, 218, 219, 228, 296, 298, 300, 303, 305, 332 | ISLIDEAWAY110-SBA | 50 | ISNORKEL064 | 340 | ITBL040 | 80, 83 |
| | 32, 45, 49, 50, 52, 56, 60, 64, 80, 83, 87, 89, 91, 98, 101, 104, 108, 147, 150, 154, 178, 182, 187, 190, 197, 200, 203, 206, 241, 278, 282, 286, 290, 315, 319, 326, 358, 360 | ISLIDESPAREBADGE | 369 | ISNORKEL067 | 178 | ITBL041 | 101, 104 |
| ISD1300 | | ISLIDESPAREBKT100 | 369 | ISNORKEL070 | 254 | ITBL048 | 200, 241 |
| | | ISLIDESPAREBKT115 | 369 | ISNORKEL074 | 98, 110 | ITBL050 | 45, 182 |
| | | ISLIDESPAREBKT45 | 369 | ISNORKEL076N | 278 | ITBL051 | 282 |
| | | ISLIDESPAREBKT70 | 369 | ISNORKEL080 | 147 | ITBL054 | 49, 52, 56 |
| | | ISLIDESPAREBKT80 | 369 | ISNORKEL090 | 294 | ITBL054-12P | 56 |
| ISD900 | 32, 138, 323, 340, 343, 346, 348 | ISLIDESPARECLUTCH | 369 | ISNORKEL110 | 50 | ITBL060 | 358 |
| ISEAT COVER | 13 | ISLIDESPAREECU | 369 | ISNORKELSPARE001 | 370 | ITBL067 | 178 |
| ISHOVEL001 | 16 | ISLIDESPAREFSTR | 369 | ISNORKELSPARE002 | 370 | ITBL074 | 98, 147 |
| ISHOWER001 | 16 | ISLIDESPARELIGHT | 369 | ISOFSHA001 | 11 | ITBL076 | 278 |
| ISHOWER003 | 16 | ISLIDESPAREMOTOR | 369 | ISOFSHA002 | 11 | ITBL082 | 197 |
| ISHOWER004 | 16 | ISLIDESPAREREMOTE | 369 | ISOLAR120 | 19 | ITBL083 | 94 |
| | 47, 54, 58, 62, 65, 66, 73, 74, 81, 84, 86, 88, 90, 92, 93, 95, 99, 102, 105, 107, 109, 113, 114, 129, 143, 148, 152, 155, 157, 181, 185, 199, 204, 205, 207, 208, 209, 234, 235, 236, 268, 277, 280, 284, 287, 289, 290, 291, 292, 351 | ISNATCH005 | 11 | ISOLAR200 | 19 | ITBL110 | 50 |
| | | ISNATCH006 | 11 | ISPEEDY | 12 | ITD1000 | 32, 133, 218, 219, 228, 296, 298, 300, 303, 305, 332 |
| | | ISNATCHROPE | 11 | ISST001 | 96, 129, 265, 266, 271, 273, 275, 280, 284, 287, 341, 344, 346, 351 | | |
| ISL6010 | | ISNORKEL 3.5" HAT | 370 | ISST004 | 297, 299 | | |
| | | ISNORKEL 3" HAT | 370 | ISST005 | 353 | ITD1300 | 32, 45, 49, 50, 52, 56, 60, 64, 80, 83, 87, 89, 91, 98, 101, 104, 108, 147, 150, 154, 178, 182, 187, 190, 197, 200, 203, 206, 241, 278, 282, 286, 290, 315, 319, 326, 358, 360 |
| | | ISNORKEL 4" HAT | 370 | ISST007 | 161, 198, 199, 204, 205, 211, 213, 236 | | |
| | | ISNORKEL001 | 286 | ISST010 | 46, 163, 165, 174, 180, 184, 188, 191 | ITD900 | 32, 138, 323, 340, 343, 346, 348 |
| ISLIDEAWAY048-E | 201 | ISNORKEL003 | 300, 303 | ISST014 | 58, 62, 70, 152 | ITDFK064 | 340, 343 |
| ISLIDEAWAY048-SBA | 201 | ISNORKEL004 | 305 | ISST017 | 77, 79, 81, 84, 99, 102, 105, 111, 142, 148 | ITDW004 | 348 |
| ISLIDEAWAY051-E | 279, 283 | ISNORKEL005 | 348 | ISST052 | 121 | ITDW009 | 323 |
| ISLIDEAWAY051-SBA | 279, 283 | ISNORKEL006 | 346 | ISST075 | 238, 240 | ITDW011 | 218, 219 |
| ISLIDEAWAY054-E | 49, 53, 57, 61, 151 | ISNORKEL009 | 308, 319, 326 | ISST083 | 95 | ITDW012 | 218, 219 |
| ISLIDEAWAY054-SBA | 49, 53, 57, 61 | ISNORKEL010 | 298 | ISST090 | 295 | ITDW013 | 332 |
| ISLIDEAWAY060-E | 358, 360 | ISNORKEL011 | 228 | ISST110 | 51 | ITDW015 | 305 |
| ISLIDEAWAY060-SBA | 358, 360 | ISNORKEL013 | 218 | ISTORE0012 | 17 | ITDW016 | 305 |
| ISLIDEAWAY067-E | 179, 183 | ISNORKEL015 | 219 | ISTORE0023 | 17 | ITDW017 | 303 |
| ISLIDEAWAY067-SBA | 179, 183 | ISNORKEL019 | 203, 210 | ISWAG0023 | 15 | ITDW018 | 300, 303 |
| ISLIDEAWAY068-E | 142 | ISNORKEL020 | 187, 190 | ISWAG0034 | 15 | ITDW019 | 303 |
| ISLIDEAWAY068-SBA | 142 | ISNORKEL021 | 64 | ISWAGBAG | 15 | ITDW020 | 296, 298 |
| ISLIDEAWAY071-E | 243 | ISNORKEL022 | 89, 108 | ISWAGPART001 | 371 | ITDW022 | 315 |
| ISLIDEAWAY072L-E | 350 | ISNORKEL023 | 308, 211, 315, 323 | ISWAGPART002 | 371 | ITDW023 | 290 |
| ISLIDEAWAY072S-E | 350 | ISNORKEL024 | 154 | ISWAGSPARE001 | 371 | ITDW024 | 286 |
| ISLIDEAWAY073-E | 48 | ISNORKEL028 | 87 | ISWAGSPARE002 | 371 | ITDW025 | 206 |
| ISLIDEAWAY073L-E | 352 | ISNORKEL032 | 126 | ITABLE0012 | 15 | ITDW026 | 206 |
| ISLIDEAWAY073S-E | 352 | ISNORKEL034 | 52, 56, 60 | ITABLE0023 | 15 | ITDW028 | 203 |
| ISLIDEAWAY074-E | 98 | ISNORKEL034XLT | 52, 56, 60, 67 | ITB001 | 34 | ITDW029 | 203 |
| ISLIDEAWAY075-E | 48, 238, 239 | ISNORKEL035 | 343 | ITB005 | 34 | ITDW031 | 190 |
| ISLIDEAWAY075RB-E | 239 | ISNORKEL036 | 76, 78, 80, 83 | ITB006 | 34 | ITDW032 | 187 |
| ISLIDEAWAY077-E | 118 | ISNORKEL037 | 358, 360 | | | ITDW037 | 49, 52, 56, 60, 150 |
| ISLIDEAWAY080-E | 147 | ISNORKEL041 | 101, 104, 110 | | | | |
| ISLIDEAWAY082-E | 197 | ISNORKEL048 | 197, 200 | | | | |
| ISLIDEAWAY083-E | 94 | ISNORKEL050 | 45, 182 | | | | |
| ISLIDEAWAY087L-E | 71 | ISNORKEL051 | 278, 282 | | | | |

Product Codes

| Part Number | Page | Part Number | Page | Part Number | Page | Part Number | Page |
|---------------|------------------|-------------|----------|-------------|----------|-------------|--|
| ITDW038 | 80, 83, 101, 104 | IWHL004 | 31 | JEEO25C | 121 | LAND006BKG | 134 |
| ITDW040 | 360 | IWINCHEXT | 11 | JEEO25CKG | 121 | LAND006BKP | 134 |
| ITDW048 | 200, 241 | IWP0023 | 33 | JEEO26B | 121 | LAND006C | 134, 135 |
| ITDW050 | 45, 178, 182 | IWT001 | 33 | JEEO26C | 121 | LAND006CKF | 134 |
| ITDW051 | 278, 282 | IWT002 | 33 | JEEO29A | 125 | LAND006CKG | 134 |
| ITDW060 | 358 | IWT003 | 33 | JEEO29B | 125 | LAND006CKP | 134 |
| ITDW064 | 340, 343 | IWT004 | 33 | JEEO29C | 125 | LAND007B | 134, 135, 137, 141 |
| ITDW074 | 98, 147 | IWT005 | 33 | JEEO30A | 125 | LAND007BKF | 135 |
| ITENTBAG001 | 22, 35 | IWT006 | 33 | JEEO30AKG | 125 | LAND007BKG | 135 |
| ITENTFAN002 | 18 | IWT007 | 33 | JEEO30AKP | 125 | LAND007BKP | 135 |
| ITENTFAN003 | 18 | IWT008 | 33 | JEEO30B | 125 | LAND007CKF | 135 |
| ITENTLIGHT002 | 18 | IWTHOSE | 33 | JEEO30BKG | 125 | LAND007CKG | 135 |
| ITOILET12 | 16 | JEEO003B | 123, 128 | JEEO30BKP | 125 | LAND007CKP | 135 |
| ITOILETA+B | 16 | JEEO003BKF | 117 | JEEO30C | 125 | LAND008B | 134 |
| ITOW | 11 | JEEO003BKG | 117 | JEEO30CKG | 125 | LAND009B | 134, 135, 136, 137, 140, 141 |
| ITRACK305 | 13 | JEEO004BD/S | 117 | JEEO30CKP | 125 | LAND009BKF | 136, 137, 141 |
| ITRACK610 | 13 | JEEO004BN/S | 117 | JEEO31B | 119 | LAND009BKG | 136, 137, 141 |
| ITRACKRING | 13 | JEEO006B | 123 | JEEO32B | 119 | LAND009BKP | 136, 137, 141 |
| ITREE | 11 | JEEO006BKG | 123 | JEEO32BKP | 119 | LAND009CKF | 136, 137, 141 |
| ITSS021 | 102, 105 | JEEO006CKG | 123 | JEEO32C | 119 | LAND009CKG | 136, 137, 141 |
| ITUB0012 | 17 | JEEO007B | 128 | JEEO32CKP | 119 | LAND009CKP | 136, 137, 141 |
| ITYRE001 | 12 | JEEO007BKG | 128 | JEEO32D | 119 | LAND011B | 136, 137, 140, 141 |
| ITYRE002 | 12 | JEEO008B | 128 | JEEO32DKP | 119 | LAND011C | 136, 137, 140, 141 |
| ITYRE004 | 12 | JEEO012B | 122 | JEEO35B | 125 | LAND014B | 134, 135, 140 |
| ITYRE005 | 12 | JEEO012BKG | 122 | JEEO35BKGL | 125 | LAND014BKF | 140 |
| ITYRE006 | 12 | JEEO012C | 122 | JEEO35BKPL | 125 | LAND014BKG | 140 |
| ITYRE007 | 12 | JEEO013B | 122 | JEEO36B | 125 | LAND014CKF | 140 |
| ITYRE008 | 12 | JEEO013C | 122 | JKBKITL | 127 | LAND014CKG | 140 |
| ITYRE009 | 12 | JEEO014B | 116 | JLKIT035 | 125 | LAND019B | 139 |
| ITYRE009PROMO | 12 | JEEO014BKG | 116 | JMC002B | 129 | LAND019C | 139 |
| IUP001K | 286 | JEEO014BKG1 | 116 | JMC002BKF | 129 | LAND020B | 139 |
| IUP004F | 298 | JEEO014C | 116 | JMC002BKG | 129 | LAND020C | 139 |
| IUP004K | 298 | JEEO015B | 116 | JMC002BKP | 129 | LC70F30 | 309, 312, 316, 320, 324, 330 |
| IUP007K | 203 | JEEO016B | 117, 123 | JMC002C | 129 | LCF20 | 266, 301, 306, 349 |
| IUP009K | 87, 89, 91, 108 | JEEO017AKG | 127 | JMC002CKF | 129 | LCF30 | 266, 301, 306, 349 |
| IUP010F | 190 | JEEO017AKP | 127 | JMC002CKG | 129 | LCPR20 | 265, 341, 344 |
| IUP014K | 56, 60, 69, 150 | JEEO017B | 127 | JMC002CKP | 129 | LCPR25 | 265, 341, 344 |
| IUP050K | 45, 178, 182 | JEEO017BKG | 127 | KEY001 | 41 | LCR15 | 302, 307 |
| IWC6T | 39 | JEEO017BKP | 127 | KEY002 | 41 | LCR30 | 302, 307 |
| IWEDGE04 | 370 | JEEO017C | 127 | KIA006B | 130 | LP2 | 129, 143, 199, 204, 205, 209, 236, 268, 280, 284, 287, 289, 290, 291, 292 |
| IWEDGE08 | 370 | JEEO018A | 127 | KIA007B | 130 | LP3 | 47, 51, 54, 58, 62, 65, 66, 73, 74, 92, 93, 95, 113, 114, 152, 155, 157, 207, 208, 234, 235, 277, 351, 353 |
| IWEDGE10 | 370 | JEEO018B | 127 | LADA001B | 131 | LP3-1 | 427 |
| IWEDGE12 | 370 | JEEO019B | 127 | LADA002B | 131 | LP3-2 | 427 |
| IWFT001 | 21 | JEEO019BKGL | 127 | LAND005BKF | 134 | | |
| IWHL001 | 31 | JEEO019BKPL | 127 | LAND005BKG | 134 | | |
| IWHL002 | 31 | JEEO20B | 127 | LAND005BKP | 134 | | |
| IWHL003 | 31 | JEEO25B | 121 | LAND006B | 134, 135 | | |
| | | JEEO25BKG | 121 | LAND006BKF | 134 | | |



Product Codes

| Part Number | Page | Part Number | Page | Part Number | Page | Part Number | Page |
|-------------|--|-------------|------------------------------|--------------|---------------|--------------|----------------------------------|
| LP4 | 144, 171, 173, 176, 189, 191, 193, 194, 195, 227, 229, 325, 327, 331, 333, 335, 336, 337, 338, 339, 359, 361 | MAZDA041BKF | 65, 155 | MAZDA041BKF1 | 172 | MAZDA041BKF1 | 172 |
| LP4-1 | 427 | MAZDA041BKG | 65, 155 | MAZDA041BKF2 | 170 | MAZDA041CKF | 189, 192 |
| LP4-2 | 427 | MAZDA041BKP | 65, 155 | MAZDA041BKG | 175 | MAZDA041CKG | 189, 192 |
| LP5 | 259 | MAZDA041C | 65, 155 | MAZDA041BKG1 | 172 | MAZDA041CKP | 189, 192 |
| LP5-1 | 427 | MAZDA041CKF | 65, 155 | MAZDA041BKG2 | 170 | MAZDA042A | 163, 165, 174 |
| LP5-2 | 427 | MAZDA041CKG | 65, 155 | MAZDA041BKG1 | 170, 172, 175 | MAZDA042AKF | 174 |
| LP7-1 | 427 | MAZDA041CKP | 65, 155 | MAZDA041BKG2 | 175 | MAZDA042AKG | 174 |
| LP7-2 | 427 | MAZDA041D | 65, 155 | MAZDA041BKG1 | 172 | MAZDA042B | 163, 165, 174 |
| LP9 | 310, 313, 317, 321 | MAZDA041DKF | 65, 155 | MAZDA041BKG2 | 170 | MAZDA042BKF | 174 |
| LP9-1 | 427 | MAZDA041DKG | 65, 155 | MAZDA041BKG1 | 175 | MAZDA042BKF1 | 163, 165 |
| LP9-2 | 427 | MAZDA041DKP | 65, 155 | MAZDA041BKG2 | 170, 172, 175 | MAZDA042BKG | 174 |
| LR12V10W | 80 | MERC015B | 159 | MAZDA041BKG1 | 170 | MAZDA042BKG1 | 163, 165 |
| LR12V21W | 98, 178, 364 | MERC015BKF | 159 | MAZDA041BKG2 | 175 | MAZDA042C | 163, 165, 174 |
| LR12V50W | 364 | MERC016B | 159 | MAZDA041BKG1 | 172 | MAZDA042CKF | 174 |
| LTA001 | 302, 306 | MERC020B | 158 | MAZDA041BKG2 | 175 | MAZDA042CKF1 | 163, 165 |
| LTA003 | 221, 225, 231, 233, 295, 304 | MERC021B | 158 | MAZDA041BKG1 | 170 | MAZDA042CKG | 174 |
| LTA200 | 297, 299 | MERC021BKF | 158 | MAZDA041BKG2 | 175 | MAZDA042CKG1 | 163, 165 |
| MAH001 | 144, 145 | MERC021BKG | 158 | MAZDA041BKG1 | 172 | MAZDA042S | 174 |
| MAH002B | 144 | MINING001 | 39 | MAZDA041BKG2 | 170 | MAZDA042SKF | 174 |
| MAH002BKG | 144 | MINING005 | 39 | MAZDA041BKG1 | 177 | MAZDA042SKG | 174 |
| MAH003B | 145 | MINING008 | 39 | MAZDA041BKG2 | 177 | MAZDA045B | 46, 163, 165, 180, 184, 188, 191 |
| MAH003BKG | 145 | MITSO13 | 170, 171, 172, 173, 195 | MAZDA041BKG1 | 177 | MAZDA045C | 46, 163, 165, 180, 184, 188, 191 |
| MAZDA005 | 65, 66, 74, 93, 114, 155, 157 | MITSO15BKF | 194 | MAZDA041BKG2 | 169 | MAZDA047A | 47, 181, 185 |
| MAZDA006A | 66, 157 | MITSO15BKF1 | 193 | MAZDA041BKG1 | 169 | MAZDA047AKF | 47, 181, 185 |
| MAZDA006AKF | 66, 157 | MITSO15BKG | 194 | MAZDA041BKG2 | 169 | MAZDA047AKG | 47, 181, 185 |
| MAZDA006AKG | 66, 157 | MITSO15BKG1 | 193 | MAZDA041BKG1 | 168 | MAZDA047B | 47, 181, 185 |
| MAZDA006AKP | 66, 157 | MITSO15C | 193, 194 | MAZDA041BKG2 | 168 | MAZDA047BKF | 47, 181, 185 |
| MAZDA006B | 66, 157 | MITSO15CKF | 194 | MAZDA041BKG1 | 168 | MAZDA047BKG | 47, 181, 185 |
| MAZDA006BKF | 66, 157 | MITSO15CKF1 | 193 | MAZDA041BKG2 | 168 | MAZDA047BKF1 | 47, 181, 185 |
| MAZDA006BKG | 66, 157 | MITSO15CKG | 194 | MAZDA041BKG1 | 168 | MAZDA047C | 47, 181, 185 |
| MAZDA006BKP | 66, 157 | MITSO15CKG1 | 193 | MAZDA041BKG2 | 168 | MAZDA047CKF | 47, 181, 185 |
| MAZDA006C | 66, 157 | MITSO18B | 171, 173, 176, 193, 194, 195 | MAZDA041BKG1 | 168 | MAZDA047CKG | 47, 181, 185 |
| MAZDA006CKF | 66, 157 | MITSO18BKF | 176 | MAZDA041BKG2 | 168 | MAZDA047CKP | 47, 181, 185 |
| MAZDA006CKG | 66, 157 | MITSO18BKF1 | 173, 195 | MAZDA041BKG1 | 168 | MAZDA047CCKG | 47, 181, 185 |
| MAZDA006CKP | 66, 157 | MITSO18BKF2 | 171 | MAZDA041BKG2 | 168 | MAZDA047CCKP | 47, 181, 185 |
| MAZDA006D | 66, 157 | MITSO18BKG | 176 | MAZDA041BKG1 | 168 | MAZDA047CCKP | 47, 181, 185 |
| MAZDA006DKF | 66, 157 | MITSO18BKG1 | 173, 195 | MAZDA041BKG2 | 168 | MAZDA047CCKP | 47, 181, 185 |
| MAZDA006DKG | 66, 157 | MITSO18BKG2 | 171 | MAZDA041BKG1 | 168 | MAZDA047CCKP | 47, 181, 185 |
| MAZDA006DKP | 66, 157 | MITSO18C | 171, 173, 176, 193, 194, 195 | MAZDA041BKG2 | 168 | MAZDA047CCKP | 47, 181, 185 |
| MAZDA014 | 66, 157 | MITSO18CKF | 176 | MAZDA041BKG1 | 168 | MAZDA047CCKP | 47, 181, 185 |
| MAZDA041A | 65, 155 | MITSO18CKF1 | 173, 195 | MAZDA041BKG2 | 168 | MAZDA047CCKP | 47, 181, 185 |
| MAZDA041AKF | 65, 155 | MITSO18CKF2 | 171 | MAZDA041BKG1 | 168 | MAZDA047CCKP | 47, 181, 185 |
| MAZDA041AKG | 65, 155 | MITSO18CKG | 176 | MAZDA041BKG2 | 168 | MAZDA047CCKP | 47, 181, 185 |
| MAZDA041AKP | 65, 155 | MITSO18CKG1 | 173, 195 | MAZDA041BKG1 | 168 | MAZDA047CCKP | 47, 181, 185 |
| MAZDA041B | 65, 155 | MITSO18CKG2 | 171 | MAZDA041BKG2 | 168 | MAZDA047CCKP | 47, 181, 185 |
| | | MITSO19 | 170, 171, 172, 173, 175, 176 | MAZDA041BKG1 | 168 | MAZDA047CCKP | 47, 181, 185 |
| | | MITSO20B | 163, 165, 170, 172, 175 | MAZDA041BKG2 | 168 | MAZDA047CCKP | 47, 181, 185 |
| | | MITSO20BKF | 175 | MAZDA041BKG1 | 168 | MAZDA047CCKP | 47, 181, 185 |
| | | | | MAZDA041BKG2 | 168 | MAZDA047CCKP | 47, 181, 185 |
| | | | | MAZDA041BKG1 | 168 | MAZDA047CCKP | 47, 181, 185 |
| | | | | MAZDA041BKG2 | 168 | MAZDA047CCKP | 47, 181, 185 |
| | | | | MAZDA041BKG1 | 168 | MAZDA047CCKP | 47, 181, 185 |
| | | | | MAZDA041BKG2 | 168 | MAZDA047CCKP | 47, 181, 185 |
| | | | | MAZDA041BKG1 | 168 | MAZDA047CCKP | 47, 181, 185 |
| | | | | MAZDA041BKG2 | 168 | MAZDA047CCKP | 47, 181, 185 |
| | | | | MAZDA041BKG1 | 168 | MAZDA047CCKP | 47, 181, 185 |
| | | | | MAZDA041BKG2 | 168 | MAZDA047CCKP | 47, 181, 185 |
| | | | | MAZDA041BKG1 | 168 | MAZDA047CCKP | 47, 181, 185 |
| | | | | MAZDA041BKG2 | 168 | MAZDA047CCKP | 47, 181, 185 |
| | | | | MAZDA041BKG1 | 168 | MAZDA047CCKP | 47, 181, 185 |
| | | | | MAZDA041BKG2 | 168 | MAZDA047CCKP | 47, 181, 185 |
| | | | | MAZDA041BKG1 | 168 | MAZDA047CCKP | 47, 181, 185 |
| | | | | MAZDA041BKG2 | 168 | MAZDA047CCKP | 47, 181, 185 |
| | | | | MAZDA041BKG1 | 168 | MAZDA047CCKP | 47, 181, 185 |
| | | | | MAZDA041BKG2 | 168 | MAZDA047CCKP | 47, 181, 185 |
| | | | | MAZDA041BKG1 | 168 | MAZDA047CCKP | 47, 181, 185 |
| | | | | MAZDA041BKG2 | 168 | MAZDA047CCKP | 47, 181, 185 |
| | | | | MAZDA041BKG1 | 168 | MAZDA047CCKP | 47, 181, 185 |
| | | | | MAZDA041BKG2 | 168 | MAZDA047CCKP | 47, 181, 185 |
| | | | | MAZDA041BKG1 | 168 | MAZDA047CCKP | 47, 181, 185 |
| | | | | MAZDA041BKG2 | 168 | MAZDA047CCKP | 47, 181, 185 |
| | | | | MAZDA041BKG1 | 168 | MAZDA047CCKP | 47, 181, 185 |
| | | | | MAZDA041BKG2 | 168 | MAZDA047CCKP | 47, 181, 185 |
| | | | | MAZDA041BKG1 | 168 | MAZDA047CCKP | 47, 181, 185 |
| | | | | MAZDA041BKG2 | 168 | MAZDA047CCKP | 47, 181, 185 |
| | | | | MAZDA041BKG1 | 168 | MAZDA047CCKP | 47, 181, 185 |
| | | | | MAZDA041BKG2 | 168 | MAZDA047CCKP | 47, 181, 185 |
| | | | | MAZDA041BKG1 | 168 | MAZDA047CCKP | 47, 181, 185 |
| | | | | MAZDA041BKG2 | 168 | MAZDA047CCKP | 47, 181, 185 |
| | | | | MAZDA041BKG1 | 168 | MAZDA047CCKP | 47, 181, 185 |
| | | | | MAZDA041BKG2 | 168 | MAZDA047CCKP | 47, 181, 185 |
| | | | | MAZDA041BKG1 | 168 | MAZDA047CCKP | 47, 181, 185 |
| | | | | MAZDA041BKG2 | 168 | MAZDA047CCKP | 47, 181, 185 |
| | | | | MAZDA041BKG1 | 168 | MAZDA047CCKP | 47, 181, 185 |
| | | | | MAZDA041BKG2 | 168 | MAZDA047CCKP | 47, 181, 185 |
| | | | | MAZDA041BKG1 | 168 | MAZDA047CCKP | 47, 181, 185 |
| | | | | MAZDA041BKG2 | 168 | MAZDA047CCKP | 47, 181, 185 |
| | | | | MAZDA041BKG1 | 168 | MAZDA047CCKP | 47, 181, 185 |
| | | | | MAZDA041BKG2 | 168 | MAZDA047CCKP | 47, 181, 185 |
| | | | | MAZDA041BKG1 | 168 | MAZDA047CCKP | 47, 181, 185 |
| | | | | MAZDA041BKG2 | 168 | MAZDA047CCKP | 47, 181, 185 |
| | | | | MAZDA041BKG1 | 168 | MAZDA047CCKP | 47, 181, 185 |
| | | | | MAZDA041BKG2 | 168 | MAZDA047CCKP | 47, 181, 185 |
| | | | | MAZDA041BKG1 | 168 | MAZDA047CCKP | 47, 181, 185 |
| | | | | MAZDA041BKG2 | 168 | MAZDA047CCKP | 47, 181, 185 |
| | | | | MAZDA041BKG1 | 168 | MAZDA047CCKP | 47, 181, 185 |
| | | | | MAZDA041BKG2 | 168 | MAZDA047CCKP | 47, 181, 185 |
| | | | | MAZDA041BKG1 | 168 | MAZDA047CCKP | 47, 181, 185 |
| | | | | MAZDA041BKG2 | 168 | MAZDA047CCKP | 47, 181, 185 |
| | | | | MAZDA041BKG1 | 168 | MAZDA047CCKP | 47, 181, 185 |
| | | | | MAZDA041BKG2 | 168 | MAZDA047CCKP | 47, 181, 185 |
| | | | | MAZDA041BKG1 | 168 | MAZDA047CCKP | 47, 181, 185 |
| | | | | MAZDA041BKG2 | 168 | MAZDA047CCKP | 47, 181, 185 |
| | | | | MAZDA041BKG1 | 168 | MAZDA047CCKP | 47, 181, 185 |
| | | | | MAZDA041BKG2 | 168 | MAZDA047CCKP | 47, 181, 185 |
| | | | | MAZDA041BKG1 | 168 | MAZDA047CCKP | 47, 181, 185 |
| | | | | MAZDA041BKG2 | 168 | MAZDA047CCKP | 47, 181, 185 |
| | | | | MAZDA041BKG1 | 168 | MAZDA047CCKP | 47, 181, 185 |
| | | | | MAZDA041BKG2 | 168 | MAZDA047CCKP | 47, 181, 185 |
| | | | | MAZDA041BKG1 | 168 | MAZDA047CCKP | 47, 181, 185 |
| | | | | MAZDA041BKG2 | 168 | MAZDA047CCKP | 47, 181, 185 |
| | | | | MAZDA041BKG1 | 168 | MAZDA047CCKP | 47, 181, 185 |
| | | | | MAZDA041BKG2 | 168 | MAZDA047CCKP | 47, 181, 185 |
| | | | | MAZDA041BKG1 | 168 | MAZDA047CCKP | 47, 181, 185 |
| | | | | MAZDA041BKG2 | 168 | MAZDA047CCKP | 47, 181, 185 |
| | | | | MAZDA041BKG1 | 168 | MAZDA047CCKP | 47, 181, 185 |
| | | | | MAZDA041BKG2 | 168 | MAZDA047CCKP | 47, 181, 185 |
| | | | | MAZDA041BKG1 | 168 | MAZDA047CCKP | 47, 181, 185 |
| | | | | MAZDA041BKG2 | 168 | MAZDA047CCKP | 47, 181, 185 |
| | | | | MAZDA041BKG1 | 168 | MAZDA047CCKP | 47, 181, 185 |
| | | | | MAZDA041BKG2 | 168 | MAZDA047CCKP | 47, 181, 185 |
| | | | | MAZDA041BKG1 | 168 | MAZDA047CCKP | 47, 181, 185 |
| | | | | MAZDA041BKG2 | 168 | MAZDA047CCKP | 47, 181, 185 |
| | | | | MAZDA041BKG1 | 168 | MAZDA047CCKP | 47, 181, 185 |
| | | | | MAZDA041BKG2 | 168 | MAZDA047CCKP | 47, 181, 185 |
| | | | | MAZDA041BKG1 | 168 | MAZDA047CCKP | 47, 181, 185 |
| | | | | MAZDA041BKG2 | 168 | MAZDA047CCKP | 47, 181, 185 |
| | | | | MAZDA041BKG1 | 168 | MAZDA047CCKP | 47, 181, 185 |
| | | | | | | | |

Product Codes

| Part Number | Page | Part Number | Page | Part Number | Page | Part Number | Page |
|-------------|--------------------|--------------|--------------------|--------------|--|--------------|--------------------|
| NISS007BKP | 233 | NISS020C | 221, 225, 231 | NISS037DKG | 222, 226 | NISS043BKP1L | 222 |
| NISS008B | 233 | NISS020CKF | 231 | NISS037DKP | 222, 226 | NISS043BKPL | 222, 226, 231, 233 |
| NISS009B | 230, 232 | NISS020CKG | 231 | NISS038B | 237 | NISS043CKF | 222, 226, 231 |
| NISS009BKF | 231, 233 | NISS020CKP | 231 | NISS039B | 237 | NISS043CKF1 | 222 |
| NISS009BKF1 | 233 | NISS020D | 221, 225, 231 | NISS040A | 161, 198, 199 | NISS043CKFL | 226, 231 |
| NISS009BKG | 231, 233 | NISS024B | 220, 224, 227 | NISS040B | 161, 198, 199, 205, 213, 236 | NISS043CKP | 222, 226, 231 |
| NISS009BKG1 | 233 | NISS024CKF | 222 | NISS040C | 161, 197, 198, 199, 200, 204, 205, 211, 213, 236 | NISS043CKP1 | 222 |
| NISS009BKP | 231, 233 | NISS024CKG | 222 | NISS040D | 161, 198, 199, 204, 211 | NISS043CKPL | 226, 231 |
| NISS009BKP1 | 233 | NISS024CKP | 222 | NISS041B | 204, 205 | NISS044B | 221, 225, 231, 233 |
| NISS009C | 220, 224, 227, 230 | NISS024DKF | 231 | NISS041BKF | 205 | NISS044C | 221, 225, 231 |
| NISS009CKF | 231 | NISS024DKG | 231 | NISS041BKF1 | 204 | NISS045A | 217 |
| NISS009CKG | 231 | NISS024DKP | 231 | NISS041BKG | 205 | NISS045AKF | 217 |
| NISS009CKP | 231 | NISS025 | 207 | NISS041BKG1 | 204 | NISS045AKG | 217 |
| NISS010B | 231, 233 | NISS025AKG | 207 | NISS041BKP | 205 | NISS045AKP | 217 |
| NISS010C | 221, 231, 233 | NISS025BKG | 207 | NISS041BKP1 | 204 | NISS045B | 217 |
| NISS011CD/S | 229 | NISS025CKG | 207 | NISS041C | 204, 205 | NISS045BKF | 217 |
| NISS011CKF | 229 | NISS026B | 220, 224, 230, 232 | NISS041CKF | 205 | NISS045BKG | 217 |
| NISS011CKG | 229 | NISS026BKF | 222, 226, 231, 233 | NISS041CKF1 | 204 | NISS045BKP | 217 |
| NISS011CKP | 229 | NISS026BKF1 | 222 | NISS041CKG | 205 | NISS045C | 217 |
| NISS011CN/S | 229 | NISS026BKF1L | 222 | NISS041CKG1 | 204 | NISS045CKF | 217 |
| NISS011DKF | 229 | NISS026BKFL | 222, 226, 231, 233 | NISS041CKP | 205 | NISS045CKG | 217 |
| NISS011DKG | 229 | NISS026BKP | 222, 226, 231, 233 | NISS041CKP1 | 204 | NISS045CKP | 217 |
| NISS011DKP | 229 | NISS026BKP1 | 222 | NISS041D | 204, 205 | NISS046A | 217 |
| NISS012CD/S | 227, 229 | NISS026BKP1L | 222 | NISS041DKF | 205 | NISS046B | 217 |
| NISS012CN/S | 227, 229 | NISS026BKPL | 222, 226, 231, 233 | NISS041DKF1 | 204 | NISS046C | 217 |
| NISS012DD/S | 227, 229 | NISS026CKF | 222, 226, 231 | NISS041DKG | 205 | NISS047B | 236 |
| NISS012DN/S | 227, 229 | NISS026CKF1 | 222 | NISS041DKG1 | 204 | NISS047BKF | 236 |
| NISS013 | 208 | NISS026CKFL | 226, 231 | NISS041DKP | 205 | NISS047BKG | 236 |
| NISS014AD/S | 207, 208 | NISS026CKP | 222, 226, 231 | NISS041DKP1 | 204 | NISS047BKP | 236 |
| NISS014AKF | 208 | NISS026CKP1 | 222 | NISS042B | 211, 213 | NISS048 | 209 |
| NISS014AKG | 208 | NISS026CKPL | 226, 231 | NISS042BKF | 213 | NISS049B | 209 |
| NISS014AN/S | 207, 208 | NISS027B | 221, 225, 231, 233 | NISS042BKF1 | 211 | NISS049BKG | 209 |
| NISS014BD/S | 207, 208 | NISS027C | 221, 225, 231 | NISS042BKG | 213 | NISS057B | 199, 202 |
| NISS014BKF | 208 | NISS034B | 214 | NISS042BKG1 | 211 | NISS057BKF | 199, 202 |
| NISS014BKG | 208 | NISS035B | 214 | NISS042C | 211, 213 | NISS057BKG | 199, 202 |
| NISS014BN/S | 207, 208 | NISS036CKF | 227 | NISS042CKF | 213 | NISS057BKP | 199, 202 |
| NISS014CD/S | 207, 208 | NISS036CKG | 227 | NISS042CKF1 | 211 | NISS057C | 199, 202 |
| NISS014CKF | 208 | NISS036CKP | 227 | NISS042CKG | 213 | NISS057CKF | 199, 202 |
| NISS014CKG | 208 | NISS036DKF | 227 | NISS042CKG1 | 211 | NISS057CKG | 199, 202 |
| NISS014CN/S | 207, 208 | NISS036DKG | 227 | NISS043B | 220, 224, 230, 232 | NISS057CKP | 199, 202 |
| NISS017 | 215 | NISS036DKP | 227 | NISS043BKF | 222, 226, 231, 233 | NISS058A | 161, 198 |
| NISS018B | 215 | NISS037BKF | 226 | NISS043BKF1 | 222 | NISS058B | 161, 198 |
| NISS018BKF | 215 | NISS037BKG | 226 | NISS043BKF1L | 222 | NISS058BKF | 161, 198 |
| NISS018BKG | 215 | NISS037BKP | 226 | NISS043BKFL | 222, 226, 231, 233 | NISS058BKG | 161, 198 |
| NISS018CKF | 215 | NISS037CKF | 222, 226 | NISS043BKP | 222, 226, 231, 233 | NISS058BKP | 161, 198 |
| NISS018CKG | 215 | NISS037CKG | 222, 226 | NISS043BKP1 | 222 | NISS058C | 161, 198 |
| NISS020B | 225 | NISS037CKP | 222, 226 | | | NISS058CKF | 161, 198 |
| | | NISS037DKF | 222, 226 | | | NISS058CKG | 161, 198 |



Product Codes

| Part Number | Page | Part Number | Page | Part Number | Page | Part Number | Page |
|-----------------|-------------------------|-------------|--|--------------|------------------|---------------|--------------------|
| NISS058CKP | 161, 198 | RTB040 | 80, 83 | SBEXT075 | 240 | SS095 RAIL | 110 |
| NISS058D | 161, 198 | RTB041 | 101, 104 | SS001 | 87, 89, 91, 108 | SS083 RAIL | 94 |
| NISS058DKF | 161, 198 | RTB048 | 200, 241 | SS007 | 203 | SS110 | 50 |
| NISS058DKG | 161, 198 | RTB050 | 45, 182 | SS008 | 64 | SS110 RAIL | 50 |
| NISS058DKP | 161, 198 | RTB051-SP | 278, 282 | SS009 | 154 | SSANG001 | 247 |
| PANHARD001 | 301, 306 | RTB051-SPR | 278 | SS012 | 218, 219 | SSANG002B | 247 |
| PANHARD002 | 302, 306 | RTB060 | 358 | SS015 | 323 | SSANG002BKF | 247 |
| PANHARD003 | 220, 224, 227, 230, 232 | RTB066 | 52, 56, 60, 150 | SS016 | 308 | SSANG002BKG | 247 |
| PANHARD004 | 221, 225, 231, 233 | RTB067GLS | 178 | SS017 | 346 | SSANG003B | 244, 245, 246, 249 |
| PANHARD005 | 220 | RTB067GLX | 178 | SS019 | 311 | SSANG003C | 244, 245, 246, 249 |
| PANHARD006 | 221 | RTB069 | 49 | SS019SC | 308 | SSANG004B | 244 |
| PANHARD007 | 301, 306 | RTB072 | 350 | SS019SC RAIL | 308 | SSANG004BKG | 244 |
| PANHARD008 | 220, 224, 227, 230, 232 | RTB073 | 352 | SS031 | 187 | SSANG004C | 244 |
| PANHARD009 | 220 | RTB074 | 98 | SS033 | 286 | SSANG004CKG | 244 |
| PANHARD010 | 127 | RTB075 | 239 | SS034 | 358, 360 | SSANG005B | 246 |
| PANHARD011 | 127 | RTB075AU | 239 | SS034 RAIL | 358, 360 | SSANG005BKG | 246 |
| PANHARD013 | 309, 312, 316, 320, 324 | RTB077JL | 124 | SS042 | 203 | SSANG005C | 246 |
| PANHARD013L | 309, 312, 316, 320, 324 | RTB077JT | 118 | SS044 | 76, 78, 110 | SSANG005CKG | 246 |
| PANHARD015 | 265, 271, 341, 344, 347 | RTB078 | 264 | SS044 RAIL | 76, 78, 110 | SSANG006B | 245 |
| PANHARD015-KDSS | 341, 344, 347 | RTB080 | 147 | SS047 | 343 | SSANG006BKG | 245 |
| PANHARD016 | 295, 297, 299 | RTB082 | 197 | SS048 | 200, 241 | SSANG006C | 245 |
| PATF15 | 220, 224, 227, 230, 232 | RTB083 | 94 | SS048 RAIL | 200, 241 | SSANG006CKG | 245 |
| PATF30 | 220, 224, 227, 230, 232 | RTB085 | 238 | SS050 | 45, 178, 182 | SSANG010B | 249 |
| PATR15 | 221, 225, 231, 233 | RTB085AU | 238 | SS050 RAIL | 45, 178, 182 | SSANG010BKG | 249 |
| PATR30 | 221, 225, 231, 233 | RTB087 | 71 | SS051 | 278, 282 | SSP019SC | 308 |
| PBC055 | 54, 68 | RTB087AU | 71 | SS051 RAIL | 278, 282 | SSP019SC RAIL | 308 |
| PDB036R | 125 | RTB110 | 50 | SS053 | 272 | SSP056 | 296 |
| PSH066E | 52, 56, 67, 69 | RTBPLATE001 | 52, 56, 60, 150, 278, 282 | SS053 RAIL | 272 | SSP056 RAIL | 296 |
| RAIDPSHUNI | 364, 371 | RTBPLATE002 | 80, 83, 101, 104 | SS054 | 52, 56, 60 | SSP064 | 340 |
| RAM015A | 238, 240 | RTBPLATE048 | 200, 241 | SS054 RAIL | 52, 56, 60 | SSP064 RAIL | 340 |
| RAM015B | 238, 240 | RTBPLATE050 | 45, 178, 182 | SS055 | 67, 69 | SSP082 | 197 |
| RAM015C | 238, 240 | RTBSPARE002 | 371 | SS055 RAIL | 67, 69 | SSP082 RAIL | 197 |
| RAM016A | 238, 240 | RTBSPARE003 | 371 | SS057 | 80, 83, 101, 104 | SSP084 | 216 |
| RAM016AKP | 240 | RTBSPARE004 | 371 | SS057 RAIL | 80, 83, 101, 104 | SSP084 RAIL | 216 |
| RAM016B | 238, 240 | RWC077JL | 124 | SS059 | 164 | SSP090 | 294 |
| RAM016BKP | 240 | SBEXT001 | 301, 306, 309, 312, 316, 320, 324, 330 | SS072 | 350 | SSR002 | 64 |
| RAM016BKP1 | 240 | SBEXT002 | 302, 307 | SS072L | 350 | SSR003 | 203 |
| RAM016C | 238, 240 | SBEXT003 | 220, 221, 224, 225, 230, 231, 232, 233 | SS073 | 352 | SSR004 | 346 |
| RAM016CKP | 240 | SBEXT004 | 221, 225 | SS074 | 98, 147 | SSR006 | 87, 89, 91, 108 |
| RAM016CKP1 | 240 | SBEXT005 | 302, 307 | SS074 RAIL | 98 | SSR007 | 154 |
| RAM017AKP | 238 | SBEXT006 | 220, 221, 224, 225, 227, 230, 231, 232, 233, 265, 271, 341, 344, 347 | SS077JL | 124 | SSR012 | 218, 219 |
| RAM017BKP | 238 | SBEXT007 | 221, 225 | SS077JT | 118 | SSR015 | 323 |
| RAM017CKP | 238 | SBEXT008 | 127 | SS078 | 264 | SSR016 | 308 |
| REN001B | 44, 242 | SBEXT035 | 125 | SS079 | 162 | SSR019 | 311 |
| REN001BKG | 44, 242 | SBEXT036 | 125 | SS082 | 197 | SSR019SC | 308 |
| REN002B | 44, 242 | | | SS082 RAIL | 197 | SSR031 | 187, 190 |
| RJTHOLDER | 118 | | | SS083 | 94 | SSR033 | 286 |
| RPB110 | 50 | | | SS095 | 110 | | |



Product Codes

| Part Number | Page | Part Number | Page | Part Number | Page | Part Number | Page |
|-------------|-------------------------|---------------|----------|-------------|------------------------|-------------|---------------|
| SSR034 | 358, 360 | SUB009CKG1 | 252 | TANK003T | 203 | TOY006BKF2 | 333 |
| SSR039 | 150 | SUB011BKG | 253 | TANK004 | 45, 178, 182, 187, 190 | TOY006BKG1 | 335 |
| SSR042 | 203 | SUB011CKG | 253 | TANK005 | 187, 190 | TOY006BKG2 | 333 |
| SSR044 | 76, 78, 110 | SUZ001BD/S | 259 | TANK006 | 64, 154 | TOY006BKP1 | 335 |
| SSR047 | 343 | SUZ001BKG | 259 | TANK007 | 52, 56, 60, 150 | TOY006BKP2 | 333 |
| SSR048 | 200, 241 | SUZ001BN/S | 259 | TANK048 | 200, 241 | TOY006C | 332, 334 |
| SSR050 | 45, 178, 182 | SUZ002B | 259 | TANK051 | 278, 282 | TOY006CKF1 | 335 |
| SSR051 | 278, 282 | SUZ002BD/S | 259 | TANK057 | 80, 83, 101, 104 | TOY006CKF2 | 333 |
| SSR053 | 272 | SUZ003B | 263 | TB040 | 80, 83 | TOY006CKG1 | 335 |
| SSR054 | 52, 56, 60 | SUZ003BKG | 263 | TB041 | 101, 104 | TOY006CKG2 | 333 |
| SSR055 | 67, 69 | SUZ004B | 263 | TB048 | 200, 241 | TOY006CKP1 | 335 |
| SSR057 | 80, 83, 101, 104 | SUZ005B | 262, 263 | TB050 | 45, 178, 182 | TOY006CKP2 | 333 |
| SSR074 | 98 | SUZ005BKG | 263 | TB051 | 278, 282 | TOY006D | 332, 334 |
| SSR080 | 147 | SUZ006B | 263 | TB066 | 52, 56, 60, 124, 150 | TOY007AD/S | 330, 333, 335 |
| SSR082 | 197 | SUZ007B | 258 | TB077JL | 124 | TOY007AN/S | 331, 333, 335 |
| SSR083 | 94 | SUZ008B | 258 | TB110 | 50 | TOY007BD/S | 330, 333, 335 |
| SSR095 | 110 | SUZ009B | 255, 257 | TOY001B | 337, 339 | TOY007BKF1 | 335 |
| SSR110 | 50 | SUZ009BKG | 257 | TOY001BKF | 339 | TOY007BKF2 | 333 |
| SSRP011 | 218 | SUZ009C | 255 | TOY001BKG | 339 | TOY007BKG1 | 335 |
| SSRP015 | 323 | SUZ010B | 255, 257 | TOY001BKP | 339 | TOY007BKG2 | 333 |
| SSRP016 | 308 | SUZ010BKG | 255 | TOY002B | 339 | TOY007BKP1 | 335 |
| SSRP019 | 311 | SUZ010BKGGVM | 384 | TOY003BKF | 337 | TOY007BKP2 | 333 |
| SSRP019SC | 308 | SUZ010BKGGVM1 | 384 | TOY003BKG | 337 | TOY007BN/S | 331, 333, 335 |
| SSRP056 | 296 | SUZ010C | 255 | TOY003BKP | 337 | TOY007CD/S | 330, 333, 335 |
| SSRP064 | 340 | SUZ010CKG | 255 | TOY003C | 337 | TOY007CKF1 | 335 |
| SSRP082 | 197 | SUZ010CKGGVM | 384 | TOY004B | 336, 338 | TOY007CKF2 | 333 |
| SSRP084 | 216 | SUZ010CKGGVM1 | 384 | TOY004BKF | 338 | TOY007CKG1 | 335 |
| SSRP090 | 294 | SUZ011B | 255, 257 | TOY004BKG | 338 | TOY007CKG2 | 333 |
| ST10RK | 419, 420, 422 | SUZ011C | 255 | TOY004BKP | 338 | TOY007CKP1 | 335 |
| ST21RK | 419, 420, 422 | SUZ013B | 262 | TOY004C | 336, 338 | TOY007CKP2 | 333 |
| ST38-1 | 418, 420, 421 | SUZ013BKG | 262 | TOY005BKF | 336 | TOY007CN/S | 333, 335 |
| ST39 | 419, 420 | SUZ015B | 262 | TOY005BKG | 336 | TOY008B | 327, 331 |
| ST710RK | 418, 419, 420, 421, 422 | SUZ016B | 262 | TOY005BKP | 336 | TOY008BKF | 327 |
| ST714RK | 418 | SUZ016BKG | 262 | TOY005C | 336 | TOY008BKG | 327 |
| ST720RK | 418, 420, 422 | SUZ017B | 262 | TOY006AKF | 335 | TOY008BKP | 327 |
| ST727RK | 419, 420, 422 | SUZ018B | 262 | TOY006AKF1 | 335 | TOY008C | 327 |
| SUB001B | 251 | SUZ018BKG | 262 | TOY006AKF2 | 333 | TOY008CKF | 327 |
| SUB002B | 251 | SUZ019AKG | 261 | TOY006AKF3 | 333 | TOY008CKG | 327 |
| SUB003B | 251 | SUZ019B | 261 | TOY006AKG | 335 | TOY008CKP | 327 |
| SUB004B | 251 | SUZ019BKG | 261 | TOY006AKG1 | 335 | TOY009B | 327 |
| SUB005B | 251 | SUZ019C | 261 | TOY006AKG2 | 333 | TOY009C | 327 |
| SUB006B | 251 | SUZ019CKG | 261 | TOY006AKG3 | 333 | TOY009D | 327 |
| SUB007BKG | 250 | SUZ020A | 261 | TOY006AKP | 335 | TOY009DKF | 327 |
| SUB007CKG | 250 | SUZ020B | 261 | TOY006AKP1 | 335 | TOY009DKG | 327 |
| SUB009BKG | 252 | SUZ020C | 261 | TOY006AKP2 | 333 | TOY009DKP | 327 |
| SUB009BKG1 | 252 | TANK001 | 323 | TOY006AKP3 | 333 | TOY009E | 327 |
| SUB009CKG | 252 | TANK002 | 286 | TOY006B | 332, 334 | TOY009EKF | 327 |
| | | TANK003 | 203 | TOY006BKF1 | 335 | TOY009EKG | 327 |



Product Codes

| Part Number | Page | Part Number | Page | Part Number | Page | Part Number | Page |
|-------------|---------------|-------------|---------------|-------------|------------------------------|---------------|--------------------|
| TOY009EKP | 327 | TOY017BKG1 | 273 | TOY038B | 86, 107, 129, 266, 349 | TOY046EKF | 317, 321 |
| TOY010BD/S | 291, 292 | TOY017BKP | 275 | TOY038BKF | 266, 349 | TOY046EKF1 | 310, 313 |
| TOY010BKF1 | 292 | TOY017BKP1 | 273 | TOY038BKF1 | 266, 349 | TOY046EKP | 317, 321 |
| TOY010BKF2 | 291 | TOY017S | 273, 275 | TOY038BKG | 266, 349 | TOY046EKP1 | 310, 313 |
| TOY010BKG1 | 292 | TOY017SKF | 275 | TOY038BKG1 | 266, 349 | TOY047A | 309, 317, 321 |
| TOY010BKG2 | 291 | TOY017SKG | 275 | TOY038BKP | 266, 349 | TOY047B | 309, 313, 317, 321 |
| TOY010BN/S | 291, 292 | TOY017SKP | 275 | TOY038BKP1 | 266, 349 | TOY047C | 309, 313, 317, 321 |
| TOY010CD/S | 291, 292 | TOY018B | 329 | TOY038C | 86, 107, 129, 266, 349 | TOY047CKFGVM | 388, 389, 390 |
| TOY010CKF1 | 292 | TOY018BKF | 329 | TOY038CKF | 349 | TOY047CKFGVM1 | 388, 389, 390 |
| TOY010CKF2 | 291 | TOY018BKG | 329 | TOY038CKF1 | 349 | TOY047CKPGVM | 388, 389, 390 |
| TOY010CKG1 | 292 | TOY019B | 329 | TOY038CKG | 349 | TOY047CKPGVM1 | 388, 389, 390 |
| TOY010CKG2 | 291 | TOY023B | 267 | TOY038CKG1 | 349 | TOY047D | 309, 313, 317, 321 |
| TOY010CN/S | 291, 292 | TOY023BKF | 267 | TOY038CKP | 349 | TOY047DKFGVM | 388, 389, 390 |
| TOY011B | 268, 291, 292 | TOY023BKG | 267 | TOY038CKP1 | 349 | TOY047DKFGVM1 | 388, 389, 390 |
| TOY011BKF | 268 | TOY023C | 267 | TOY039A | 266, 349 | TOY047DKPGVM | 388, 389, 390 |
| TOY011BKG | 268 | TOY023CKF | 267 | TOY039B | 266, 349 | TOY047DKPGVM1 | 388, 389, 390 |
| TOY011C | 268, 291, 292 | TOY023CKG | 267 | TOY039C | 266, 349 | TOY047E | 309, 313, 317, 321 |
| TOY011CKF | 268 | TOY024B | 301, 306 | TOY042 | 277 | TOY047EKFGVM | 388, 389, 390 |
| TOY011CKG | 268 | TOY024BKF | 302, 307 | TOY044C | 277 | TOY047EKFGVM1 | 388, 389, 390 |
| TOY012C | 301, 306 | TOY024BKG | 302, 307 | TOY044CKF | 277 | TOY047EKPGVM | 388, 389, 390 |
| TOY012CKF1 | 302, 307 | TOY024BKP | 302, 307 | TOY044CKG | 277 | TOY047EKPGVM1 | 388, 389, 390 |
| TOY012CKF1L | 302, 307 | TOY024C | 301, 306 | TOY046A | 309, 312, 316, 320, 324, 330 | TOY048B | 328 |
| TOY012CKF2 | 302, 307 | TOY024CKF | 302, 307 | TOY046AKF | 317, 321 | TOY048BKF | 328 |
| TOY012CKF2L | 302, 307 | TOY024CKG | 302, 307 | TOY046AKF1 | 310 | TOY048BKG | 328 |
| TOY012CKP1 | 302, 307 | TOY024CKP | 302, 307 | TOY046AKG | 317, 321 | TOY048C | 328 |
| TOY012CKP1L | 302, 307 | TOY024DKF | 302, 307 | TOY046AKG1 | 310 | TOY048CKF | 328 |
| TOY012CKP2 | 302, 307 | TOY024DKG | 302, 307 | TOY046AKP | 317, 321 | TOY048CKG | 328 |
| TOY012CKP2L | 302, 307 | TOY024DKP | 302, 307 | TOY046AKP1 | 310 | TOY049B | 328 |
| TOY013B | 301, 304, 306 | TOY025B | 301, 306 | TOY046B | 309, 312, 316, 320, 324, 330 | TOY049C | 328 |
| TOY013C | 301, 306 | TOY025C | 301, 304, 306 | TOY046BKF | 317, 321 | TOY050 | 304 |
| TOY013D | 301, 306 | TOY025D | 301, 304, 306 | TOY046BKF1 | 310, 313 | TOY050BKF | 304 |
| TOY016AKF | 331 | TOY026 | 267, 268, 290 | TOY046BKG | 317, 321 | TOY050BKG | 304 |
| TOY016AKG | 331 | TOY027A | 290 | TOY046BKG1 | 310, 313 | TOY050BKP | 304 |
| TOY016AKP | 331 | TOY027AKF | 290 | TOY046BKP | 317, 321 | TOY050CKF | 304 |
| TOY016BKF | 331 | TOY027AKG | 290 | TOY046BKP1 | 310, 313 | TOY050CKG | 304 |
| TOY016BKG | 331 | TOY027B | 290 | TOY046C | 309, 312, 316, 320, 324, 330 | TOY050CKP | 304 |
| TOY016BKP | 331 | TOY027BKF | 290 | TOY046CKF | 317, 321 | TOY050DKF | 304 |
| TOY017A | 273, 275 | TOY027BKG | 290 | TOY046CKF1 | 310, 313 | TOY050DKG | 304 |
| TOY017AKF | 275 | TOY027C | 290 | TOY046CKG | 317, 321 | TOY050DKP | 304 |
| TOY017AKF1 | 273 | TOY027CKF | 290 | TOY046CKG1 | 310, 313 | TOY051 | 304 |
| TOY017AKG | 275 | TOY027CKG | 290 | TOY046CKP | 317, 321 | TOY051BKF | 304 |
| TOY017AKG1 | 273 | TOY034B | 338 | TOY046CKP1 | 310, 313 | TOY051BKG | 304 |
| TOY017AKP | 275 | TOY038AKF | 266, 349 | TOY046DKF | 317, 321 | TOY051BKP | 304 |
| TOY017AKP1 | 273 | TOY038AKF1 | 349 | TOY046DKF1 | 310, 313 | TOY051CKF | 304 |
| TOY017B | 273, 275 | TOY038AKG | 266, 349 | TOY046DKG | 317, 321 | TOY051CKG | 304 |
| TOY017BKF | 275 | TOY038AKG1 | 349 | TOY046DKG1 | 310, 313 | TOY051CKP | 304 |
| TOY017BKF1 | 273 | TOY038AKP | 266, 349 | TOY046DKP | 317, 321 | TOY051DKF | 304 |
| TOY017BKG | 275 | TOY038AKP1 | 349 | TOY046DKP1 | 310, 313 | | |

Product Codes

| Part Number | Page | Part Number | Page | Part Number | Page | Part Number | Page |
|----------------|-------------------------|-------------|---|---------------|-------------------------|--------------------|---------|
| TOY077DKF1GVM1 | 385 | UBP041MK | 371 | UCAB054 | 370 | WWB12000SR | 10 |
| TOY077DKFGVM | 385 | UBP047 | 264, 270, 340, 343 | UCAB056 | 370 | WWB9500 | 10 |
| TOY077DKFGVM1 | 385 | UBP047MK | 371 | UCAB073 | 370 | WWB9500SR | 10 |
| TOY077DKG | 281, 285 | UBP048 | 200, 241 | UCAB074 | 370 | WWBCP001 | 372 |
| TOY077DKP | 281, 285 | UBP048MK | 371 | UCAB075 | 370 | WWBCP110 | 50, 372 |
| TOY077DKP1GVM | 385 | UBP048S | 197, 200, 241 | UTA001 | 302, 306 | WWWBRAKE | 371 |
| TOY077DKP1GVM1 | 385 | UBP050 | 45, 162, 178, 182 | UTA003 | 221, 225, 231, 233, 304 | WWW CARTON12 | 372 |
| TOY077DKPGVM | 385 | UBP050MK | 371 | UTA200 | 297, 299 | WWW CARTON95 | 372 |
| TOY077DKPGVM1 | 385 | UBP051 | 272, 278, 282 | VOLKS001B | 359, 361 | WWWCLUTCH | 371 |
| TOY079B | 309, 312, 316, 320, 324 | UBP051MK | 371 | VOLKS001BKG | 359, 361 | WWWDRUM | 371 |
| TOY080A | 269 | UBP054 | 56, 60, 69, 150 | VOLKS001C | 359, 361 | WWWDRUMBUSH | 372 |
| TOY080AKG | 269 | UBP054MK | 371 | VOLKS001CKG | 359, 361 | WWWENDPLATE GBOX | 372 |
| TOY082A | 269 | UBP055 | 52, 56, 67, 150 | VOLKS001D | 359, 361 | WWWENDPLATE MOTOR | 372 |
| TOY083A | 295 | UBP055MK | 371 | VOLKS002B | 359, 361 | WWWFAIRLEAD | 372 |
| TOY083B | 295 | UBP056 | 296, 298 | VOLKS002C | 359, 361 | WWWHAWSE | 10 |
| TOY083BKF | 295 | UBP056MK | 371 | WINCH BLANKET | 10, 371 | WWWMOTOR12 | 372 |
| TOY083BKP | 295 | UBP057 | 76, 80 | WWB001 | 371 | WWWMOTOR95 | 372 |
| TOY083CKF | 295 | UBP057MK | 371 | WWB002 | 371 | WWWORING | 372 |
| TOY083CKP | 295 | UBP070 | 254 | WWB003 | 371 | WWWREMOTE WIRELESS | 372 |
| TOY088C | 295 | UBP072 | 350 | WWB003B | 371 | WWWROPE001 | 10 |
| TOY084A | 295 | UBP073 | 352 | WWB004 | 371 | WWWTAG12 | 372 |
| TOY084B | 295 | UBP074 | 98, 147 | WWB004B | 371 | WWWTAG95 | 372 |
| TOY084C | 295 | UBP074S | 98, 110, 147 | WWB005 | 371 | | |
| TOY084D | 295 | UBP090 | 294 | WWB006 | 371 | | |
| TROL001B | 354 | UBP110 | 50 | WWB007 | 371 | | |
| TROL001BKG | 354 | UBP201SY | 243, 248 | WWB008 | 371 | | |
| TROL002B | 354 | UBP201SYMK | 371 | WWB009 | 371 | | |
| TROL003B | 355 | UCA001FA | 265, 271, 273, 275, 280, 284, 287, 341, 344, 346, 351 | WWB010 | 371 | | |
| TROL003BKG | 355 | UCA001FAS | 95 | WWB011 | 371 | | |
| TROL004B | 355 | UCA041FA | 77, 81, 142 | WWB012 | 371 | | |
| UBJ001K | 370 | UCA041FAS | 79, 84, 102, 105, 111 | WWB013 | 371 | | |
| UBJ041K | 370 | UCA048FA | 198, 199, 204, 205, 211, 213, 236 | WWB014 | 371 | | |
| UBJ041SK | 370 | UCA050FA | 46, 163, 165, 180, 184, 188, 191 | WWB015 | 371 | | |
| UBJ048K | 370 | UCA054FA | 54, 58, 62, 68, 70, 152 | WWB016 | 371 | | |
| UBJ050K | 370 | UCA056FA | 297, 299 | WWB017 | 371 | | |
| UBJ054K | 370 | UCA073FA | 353 | WWB018 | 371 | | |
| UBJ056K | 370 | UCA074FA | 99, 148 | WWB019 | 372 | | |
| UBJ073K | 370 | UCA075FA | 238, 240 | WWB020 | 372 | | |
| UBJ074K | 370 | UCA090FA | 295 | WWB021 | 372 | | |
| UBJ075K | 370 | UCA110FA | 51 | WWB022 | 372 | | |
| UBJ090K | 370 | UCAB001 | 370 | WWB023 | 371 | | |
| UBP019 | 308, 311, 315, 323 | UCAB041 | 370 | WWB024 | 371 | | |
| UBP019MK | 371 | UCAB041S | 370 | WWB025 | 371 | | |
| UBP019SC | 308 | UCAB048 | 370 | WWB026 | 371 | | |
| UBP019SCMK | 371 | UCAB050 | 370 | WWB030 | 10, 372 | | |
| UBP033 | 286 | | | WWB031 | 10, 372 | | |
| UBP033MK | 371 | | | WWB032 | 10, 50, 372 | | |
| UBP041 | 78, 83, 101, 104, 110 | | | WWB12000 | 10 | | |

Terms and Conditions

1. Interpretation

In these Terms and Conditions of Sale ("Terms"), "Goods" means the Goods the subject of the Contract; IRONMAN 4X4 Pty. Ltd. means the entity selling the Goods; "Buyer" means the entity purchasing the Goods; "Contract" means each contract between IRONMAN 4X4 Pty. Ltd. and the Buyer for the sale and purchase of the Goods and "order" includes "offer".

2. Terms and Conditions

The only Terms of the Contract are those agreed to in writing by IRONMAN 4X4 Pty. Ltd. These Terms (to the extent they are not inconsistent with Terms agreed to in writing by IRONMAN 4X4 Pty. Ltd.) and those which are implied or imposed by law (including the Trade Practices Act 1974) to the extent that it is not lawful or possible to exclude them. All other Terms, Conditions and Warranties are expressly excluded. If a conflict arises between the Terms of any order made by the Buyer and these Terms, these Terms will prevail. An agreement to deliver the Goods in instalments is taken to be a separate Contract for each instalment. These Terms and each Contract including them are governed by the laws of New South Wales, and IRONMAN 4X4 Pty. Ltd. and the Buyer submit to the jurisdiction of the courts of that State. If a Term is held to be unenforceable, the remaining Terms will apply.

3. Quotations and Orders

Any quotation made by IRONMAN 4X4 Pty. Ltd. will not be construed or operate as an offer or obligation to sell. IRONMAN 4X4 Pty. Ltd. reserves the right to accept or reject in its absolute discretion any order received by it. The Buyer will not be entitled to cancel or refuse delivery of, or payment for, any order made by it which has been accepted by IRONMAN 4X4 Pty. Ltd.

4. Price

The price payable to IRONMAN 4X4 Pty. Ltd. by the Buyer for the Goods will be the price agreed; failing which it will be the price prevailing at the date the Goods are dispatched by IRONMAN 4X4 Pty. Ltd. for delivery to the Buyer. Prices are payable in Australian currency and exclusive of delivery costs, taxes, duties and other imposts which, if changeable, are payable by the Buyer. Prices quoted in any IRONMAN 4X4 Pty. Ltd. Price List are suggested prices only and may be changed by IRONMAN 4X4 Pty. Ltd. without notice.

5. Payment

The Buyer must pay cash for the Goods on delivery or, at IRONMAN 4X4 Pty. Ltd.'s absolute discretion, strictly within 30 days of delivery. IRONMAN 4X4 Pty. Ltd. will appropriate payments first to outstanding interest and then to outstanding accounts in the date order rendered.

6. Overdue Amounts

If Buyer fails to pay all or part of any amount to IRONMAN 4X4 Pty. Ltd. when due, interest will be payable on that amount from its due date until it is paid in full at a rate equivalent to 2% per annum above the overdraft rate from time to time charged to IRONMAN 4X4 Pty. Ltd. by its principal banker.

7. Delivery

IRONMAN 4X4 Pty. Ltd. will make all reasonable efforts to deliver the Goods on the dates agreed, to the place or carrier designated by the Buyer. IRONMAN 4X4 Pty. Ltd. has the right to make delivery in instalments and to deliver those Goods available for delivery. The Buyer has no right to terminate the Contract because of a delay in delivery.

8. Warranty

IRONMAN 4X4 Pty. Ltd. warrants that its products are manufactured to S.A.E.- Society of Automotive Engineers - specifications for the particular product. IRONMAN 4X4 Pty. Ltd. further warrants that all products sold hereunder are free from defects in material and workmanship.

IRONMAN 4X4 Pty. Ltd. will, at its sole option, repair or replace any products supplied by it which are found to be defective in either materials or workmanship providing that IRONMAN 4X4 Pty. Ltd. is actually notified in writing from the Buyer of the alleged defect within ninety (90) days from the date of invoice. Any claim not made within this period shall conclusively be deemed waived by the Buyer. Repair or replacement is preconditioned on the examination of the Goods by IRONMAN 4X4 Pty. Ltd. and, if requested by IRONMAN 4X4 Pty. Ltd. return of the Goods to IRONMAN 4X4 Pty. Ltd.

No products are to be returned to IRONMAN 4X4 Pty. Ltd. without its written consent, according to procedures outlined in this manual, and the receipt by the Buyer of specific shipping instructions. IRONMAN 4X4 Pty. Ltd. shall not be liable for any expense incurred by the Buyer in order to remedy any defect in its products. IRONMAN 4X4 Pty. Ltd. shall not be liable for any consequential, special, indirect or contingent damage, or expense arising directly or indirectly from any defect in its products or from use of any products. This warranty does not apply to (1) Goods bought for industrial, mining or agricultural use, (2) Goods bought for resupply or resale, (3) Goods no longer required by the Buyer, (4) Goods incorrectly chosen by the Buyer; or (5) Goods modified or altered by the Buyer (including changing colour).

Except as set forth herein, and except as to title, it is expressly agreed (A) that there is no warranty or merchantability or fitness for a particular purpose, nor other warranty express, implied or statutory nor any affirmation of fact, or promises by IRONMAN 4X4 Pty. Ltd. with reference to the goods which extends beyond the specifications, agreed upon by IRONMAN 4X4 Pty. Ltd. and the Buyer and (b) that the Buyer if any, mutually acknowledges that it is purchasing the goods solely on the basis of the commitments of IRONMAN 4X4 Pty. Ltd. expressly set forth herein. No person is authorised to change or add to any of IRONMAN 4X4 Pty. Ltd.'s obligations under this warranty. In no event shall IRONMAN 4X4 Pty. Ltd. be liable for anticipated profits or for incidental or consequential damages.

The Buyer agrees to indemnify and hold IRONMAN 4X4 Pty. Ltd. harmless from and against any loss, injury or damage, to person or property, that extends beyond the warranties set forth above, whether the claims against IRONMAN 4X4 Pty. Ltd. or the damages are incidental or consequential.

1 Year Warranty - Accessories / Mining Accessories / Underbody Protection

2 Year Warranty - Premium Underbody Protection / GVM Upgrades / Load Plus

3 Year Components Warranty - Ice Cube Fridge/Freezers

3 Year 60,000km Warranty - Suspension

5 Year Warranty - Monster Winches, Snorkel

5 Year Compressor Warranty - Ice Cube Fridge/Freezers

Lifetime Limited Warranty - TREDs

IRONMAN 4X4 Pty. Ltd. warrants the original buyer, only when purchased new via authorised IRONMAN 4X4 Pty. Ltd. resellers and distributors, from date of sale.

Product is warranted against defects in material or workmanship that cause the product to perform below the specified limits set by IRONMAN 4X4 Pty. Ltd., to the extent that IRONMAN 4X4 Pty. Ltd. will repair or replace any parts which are found to be defective.

All warranty claims must be submitted via original purchasing store or chain, unless otherwise arranged.

Proof of original purchase must be presented upon request.

Products may require to be returned to IRONMAN 4X4 Pty. Ltd. for assessment or repair. Postage and removal costs involved are not the responsibility of IRONMAN 4X4 Pty. Ltd., and may only be considered upon discretion by IRONMAN 4X4 Pty. Ltd. in the event of such claim being verified.

The warranty does NOT apply where, 1) acts of neglect or misuse are evident, 2) product has been modified, 3) vehicles which are modified or not the recommended vehicle of use, 4) used in racing or competition conditions without the prior consent of IRONMAN 4X4 Pty. Ltd., 5) used beyond the expectations of the original vehicle manufacturer.



Terms and Conditions

Before installation of any product, please ensure you have received the correct parts for your application.

Ordering of the correct parts is the responsibility of the Buyer. Return of a product in an unused condition will attract a 15% restock fee, where IRONMAN 4X4 Pty. Ltd. is not at fault.

Return of used or soiled product, 1) outside warranty period, 2) without fault, will result in refusal of your claim and be returned at the Buyer's expense.

Damage to products through fitment error is not covered under warranty.

9. Damage

The Buyer acknowledges that the Goods leaving IRONMAN 4X4 Pty. Ltd's premises are adequately packed. Claims for damage in transit must be made against the carrier and, while IRONMAN 4X4 Pty. Ltd. will not accept liability for any damage, details of any claim must be promptly advised to IRONMAN 4X4 Pty. Ltd. Prior to acknowledging delivery to the carrier, the Buyer must ensure that the complete consignment has been received as specified in the carrier's note. Any shortage or visible damage to outer packaging must be endorsed on the carrier's note. Any shortages and/or damages must be reported to IRONMAN 4X4 Pty. Ltd. within 72 hours or receipt.

10. Title

10.1 Title to the Goods will not pass to the Buyer until the earlier of:

- (a) IRONMAN 4X4 Pty. Ltd. being paid in full under all Contracts; or
- (b) the sale by the Buyer of the Goods in its ordinary course of business (in which case the Buyer must keep an accurate account of each sale, hold the proceeds of each sale separate from the Buyer's own money and pay IRONMAN 4X4 Pty. Ltd. in full from the proceeds of the purchase price of each sale, despite that the payment is not otherwise due).

10.2 Until title to the Goods passes to the Buyer, the Buyer must:

- (a) hold the Goods as bailed for IRONMAN 4X4 Pty. Ltd. and keep them in good order and condition;
- (b) not remove any markings placed by IRONMAN 4X4 Pty. Ltd. and ensure that the Goods can be readily identified and distinguished from other property in the Buyer's possession; and
- (c) deliver the Goods to IRONMAN 4X4 Pty. Ltd. immediately upon demand and, for this purpose, IRONMAN 4X4 Pty. Ltd. is authorised to enter at any time any premises on which the Goods may be located (the costs incidental to which will be borne by the Buyer).

11. Risk

Risk in the Goods (including insurance responsibility) passes to the Buyer on delivery of the Goods to the place or carrier designated by the Buyer or, if sooner, possession of the Goods passes to the Buyer or its agent.

12. Implied Terms, Limitation of Liability and Buyers Indemnity

12.1 Subject to Clause 2, IRONMAN 4X4 Pty. Ltd's liability for any breach of a condition or warranty imposed or implied by law in respect of any Goods or services which are not of a kind ordinarily acquired for personal, domestic or household use or consumption (provided that this provision does not apply if the Buyer establishes that it is not fair or reasonable for IRONMAN 4X4 Pty. Ltd. to rely on it) will be limited to:

- (a) in the case of Goods supplied, any one or more of the following (as IRONMAN 4X4 Pty. Ltd. may determine):
 - (i) replacement of the Goods or the supply of equivalent goods; (ii) repair of the Goods;
 - (iii) payment of the cost of replacing the Goods or of acquiring or obtaining equivalent goods; or

(iv) payment of the cost of having the Goods repaired; and

(b) in the case of services supplied, any one of the following (as IRONMAN 4X4 Pty. Ltd. may determine);

(i) supplying the services again; or (ii) payment of the costs of having the services supplied again.

12.2 Subject to these Terms, IRONMAN 4X4 Pty. Ltd. will not be liable for any loss, damage, expense or injury of any kind or nature suffered or incurred by the Buyer or any other person, arising out of or in connection with, the Contract (including, without limitation, liability due to negligence or wilful default of IRONMAN 4X4 Pty. Ltd. and any delay in delivery) or any error (whether negligent or not) in information supplied to the Buyer in connection with its subject matter or the use, possession or delivery of the Goods or the exercise by IRONMAN 4X4 Pty. Ltd. of its rights under Clause 16 and the Buyer will indemnify IRONMAN 4X4 Pty. Ltd. in relation to any such loss, damage, expense or injury.

13. Claims

Any claim made by the Buyer must be in writing and contain the particulars specified in the IRONMAN 4X4 Pty. Ltd's 'Application for Exchange or Credit' or 'Applications for Warranty' and be received by IRONMAN 4X4 Pty. Ltd. within 14 days after delivery of the Goods. Subject to the Contract, no claim for credit will be recognised where (1) the Goods are made to special order or the Buyer's specifications or drawings, (2) are no longer required by the Buyer, (3) are returned without the particulars required by this Clause, (4) the Buyer has modified or altered the Goods (including changing colour) or (5) if the IRONMAN 4X4 Pty. Ltd. Catalogue stipulates that return will not be accepted. If the Buyer insists on returning the Goods, it must pay IRONMAN 4X4 Pty. Ltd. a handling fee equal to 40% of the price of the Goods.

14. Force Majeure

Despite any other Term or condition of the Contract, IRONMAN 4X4 Pty. Ltd. will not be liable for any loss, damage, expense or injury of any kind or nature suffered or incurred by the Buyer or any other person, arising out of or in connection with any delay in delivery, or failure to perform any other term or condition of the Contract where that delay or failure is caused by an act of God, fire, labour dispute, civil commotion, intervention of a Government, inability to obtain labour, materials or manufacturing facilities, accidents, interruptions of or delay in transportation or any other cause beyond IRONMAN 4X4 Pty. Ltd's reasonable control

15. Errors or Omissions

IRONMAN 4X4 Pty. Ltd. has the right to correct any clerical errors or omissions, whether in computation or otherwise in any quotation, acknowledgment or document forming part of a Contract.

16. Breach by Buyer

If the Buyer breaches a Contract or IRONMAN 4X4 Pty. Ltd. is not satisfied of a Buyer's ability to pay or otherwise comply with each Contract, IRONMAN 4X4 Pty. Ltd. may by notice to the Buyer, but without compensation, terminate every Contract, suspend or cease deliveries under all Contracts, set-off all deposits against amounts due and made all amounts then outstanding by the Buyer to IRONMAN 4X4 Pty. Ltd. immediately due and payable.

17. Waiver

IRONMAN 4X4 Pty. Ltd's right under the Contract are cumulative and in addition to any other rights. No delay or failure by IRONMAN 4X4 Pty. Ltd. to enforce any right is a waiver of that right. Any waiver by IRONMAN 4X4 Pty. Ltd. of any term or breach of the Contract is not to be taken as a continuing waiver or a waiver of any subsequent breach.



4WD AND TOURING
GEAR PRODUCT

ACCESSORIES AND SUSPENSION
PRODUCT BY VEHICLE

ACCESSORY SPARE PARTS

PRODUCT INSTALL
TIME GUIDE

GVM UPGRADES

SUSPENSION SELECTION
AND INFORMATION

SUSPENSION TECHNICAL
SPECIFICATIONS

ACCESSORY SELECTION
AND INFORMATION

ACCESSORY TECHNICAL
SPECIFICATIONS

PRODUCT CODE QUICK
REFERENCE

VICTORIA

2-8 Bessemer Drive,
Dandenong South, VIC 3175

NEW SOUTH WALES

22 Yilen Close,
Beresfield, NSW 2322

QUEENSLAND

160 Robinson Road East,
Geebung, QLD 4034

SOUTH AUSTRALIA

24 Cheltenham Parade,
Woodville, SA 5011

WESTERN AUSTRALIA

Cnr Baile Road and Craft Street,
Canning Vale, WA 6155

TO CONTACT IRONMAN 4X4
CALL 1300 731 137 OR VISIT US AT:
www.ironman4x4.com

 Find us on Facebook
facebook.com/Ironman4x4au