

# LandCruiser 70



Please Note: information is accurate as at November 2023.

Specification and imagery are indicative and should only be used as a guide. Vehicle and accessory specification, features, colour and trim may differ at the time of vehicle delivery.



# OH WHAT A FEELING

You'll feel it with every drive. In every twist and every turn. It's our unwavering commitment to move you, not only today, but well into tomorrow as we relentlessly reimagine the future of mobility.

With our eyes on the horizon, we're committed to creating a future where all of humankind is empowered with the freedom to move.

03	Exterior Design	10	Performance	15	Troop Carrier
06	Interior Design	11	Toyota Safety Sense	17	Colours
07	Configurations	12	Single-Cab Cab-Chassis	18	Accessories
08	Interior grades	13	Double-Cab Cab-Chassis	21	Toyota Advantage
09	Safety	14	Wagon		

# Modern, purposeful with legendary strength.



The LandCruiser legend follows a path right back to 1957 and the Snowy Mountains Scheme. It was here the original LandCruiser forged its place in Australian folklore. Then through the years, as the work and demands got tougher,

LandCruiser got stronger. From the Bass Strait pipeline projects to the roughest rural, mining and construction sites, LandCruiser became the 'go to' vehicle you could always count on. Today, LandCruiser 70 Series are the uncompromising

workhorses of the LandCruiser line-up. Delivering legendary strength combined with muscled-up looks, stacks of grunt and a truckload of impressive features and comforts inside.

# A tough, work hardened physique.

.....



The rugged good looks of the LandCruiser 70 Series are more than just skin deep. The tough steel body is built upon a full steel chassis to provide a strong stable platform.

Not only is the wide body design suitably muscular with real on-road presence, it also accommodates a choice of engine up front. And the A-pillar mounted snorkel helps your engine breathe better, particularly in dusty conditions.

That large, impressive looking front bumper is purposely designed to give a great approach angle, so you can maximise clearance when lumbering over tough terrain.

And there's plenty of glass area to maximise visibility and come nightfall, LED headlamps and LED Daytime Running Lamps help show the way ahead.

# Shaping up to the challenge



Regardless of the LandCruiser 70 you choose, you'll have a vehicle purpose built from the ground up to get stuck into the rough stuff.

The practical WorkMate in the Single-Cab and Double-Cab Cab-Chassis models, the Wagon and the Troop Carrier, is fitted with a black front bumper, radiator grille and mirrors.

16" alloy wheels come as standard on the GX and GXL Single-Cab, GXL Double-Cab Cab-Chassis and GXL Wagon grades.

All GXL models except the Troop Carrier feature over-fender flares and front wide mudguards as well as central locking. Chrome roof drop moulding and bumper are all standard on the

GXL Single-Cab, Double-Cab Cab-Chassis, Wagon and the Troop Carrier models. These models, as well as WorkMate grades, also feature chrome door handles.



## Comfort right up to the task

Whether you're doing a long haul behind the wheel or long hours on the tools, the interior features and comforts in LandCruiser 70 will help lighten the load.

An engine immobiliser is standard and helps ensure no-one drives your LandCruiser 70 without the nod from you. The lockable glove box also helps keep your valuables in place.

The standard audio system is controlled by a 6.7" colour touchscreen display with Apple CarPlay<sup>®1</sup> and Android Auto,<sup>TM1</sup> USB input,<sup>2</sup> and Bluetooth<sup>®2,3</sup> connectivity to keep the music working overtime.

In the GXL, you'll also have the convenience of power windows and central locking.

# Built to work your way

With a trusty beast that goes almost anywhere, does almost anything, you'll also appreciate the flexibility to load it the way you need. Across the LandCruiser 70 Series, you'll find versatile seating and cabin arrangements that are designed to handle the demands of many different jobs and situations.

In the Double-Cab Cab-Chassis and Wagon models, you'll have enough room to seat five adults and throw in their gear as well as the dog. And when you need to haul the whole crew up to the coalface, Troop Carriers can carry two or five people.

Plus the wide opening rear doors on the Wagon and Troop Carrier make it a breeze to load people and heavy gear.

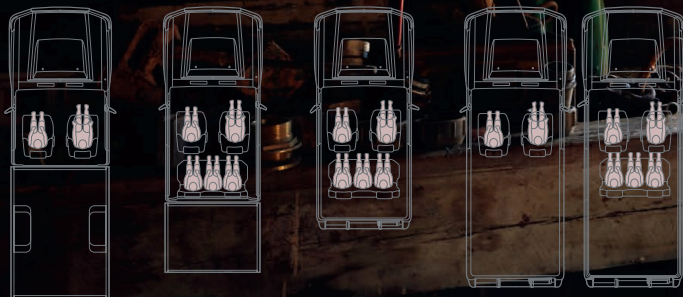

A

B

C

D

A Single-Cab Cab-Chassis – GXL and GX/WorkMate

B Double-Cab Cab-Chassis – GXL/WorkMate

C 5-seat Wagon – GXL/WorkMate

D 2-seat WorkMate and 5-seat GXL Troop Carrier

Images shown are for illustration purposes only. For full dimensions of the vehicle, please refer to [toyota.com.au/landcruiser-70](http://toyota.com.au/landcruiser-70) for spec table.

Double-Cab Cab-Chassis GXL model in Merlot Red<sup>7</sup> shown with optional Toyota Genuine tray body and under body tyre hanger<sup>8</sup> – sold separately

# Hardened outside, welcoming within.



Even when you're out battling the toughest jobs and terrain, inside you'll find LandCruiser 70 delivers the goods by combining functionality with comfort, as well as being equipped with a host of standard features.

The vinyl seating and vinyl flooring is designed to handle dust and mud and wipe down fast when the rough stuff is done. On the GXL you'll enjoy the extra comfort of fabric seat trim and carpet flooring.<sup>6</sup> Whichever way you go, you'll have the luxury of seats offering deep cushioning to help soak up the bumps and reduce fatigue on long, hard days.



- A Instrument cluster
- B Centre console and cup holder
- C Dual USB-C chargers
- D 6-speed automatic transmission – 2.8L turbo diesel only
- E Door pocket bottle holder



# Tough with a tender heart



LandCruiser 70 Series boasts all the grunt and muscle you need to get into uncharted territory. But it also packs in a heap of advanced features to help get you safely home again.

If called upon, the big, powerful ventilated disc brakes all round are ready to slow things down in a hurry. Plus an Anti-lock Braking System is standard across the range.

The collapsible steering column has been designed to help provide protection in real life emergency situations, whilst the side intrusion beams help protect you from side-on collisions. These no nonsense measures are further enhanced by driver and front passenger SRS airbags, as well as Emergency Locking Retractor seatbelts for the outer positions in the front cabin that also come standard across the range.

Not forgetting the little ones, Child Restraint System upper tether anchors allow the easy fitting of child seats in the 5-door Wagons.

- A Side impact beams
- B Disc brakes
- C Anti-lock Braking System (ABS)
- D Rigid frame and body structure

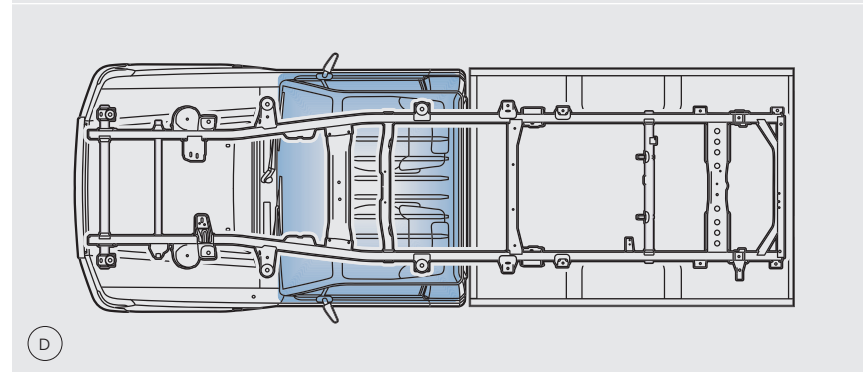
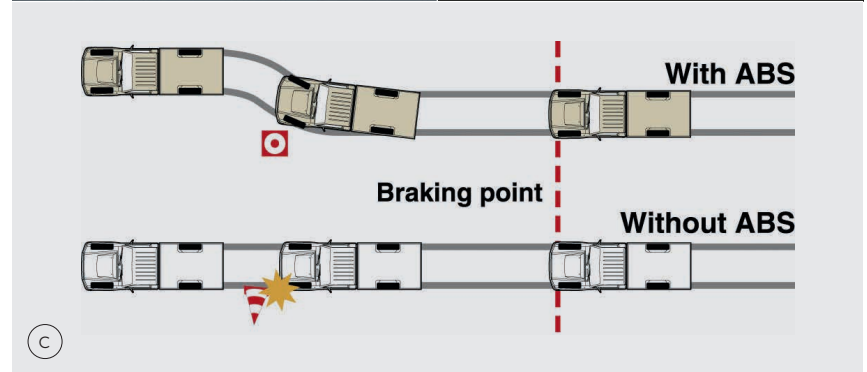
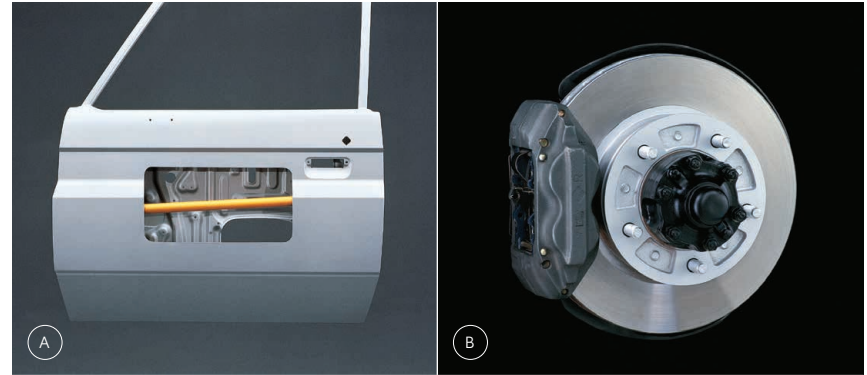

# Real power, no sweat.

A real workhorse needs a big heart, and it'd be hard to find anything with more get-up and go than the LandCruiser 70 Series.

Now featuring two powertrain options, the legendary 4.5L V8 turbo diesel engine delivers enough grunt to help make tough jobs easy. With 151kW of power coming on strong at just 3,400rpm, and 430Nm of torque all the way from 1,200-3,200rpm, you get quick acceleration, big pulling power on steep hills and the muscle to haul heavy loads.<sup>8</sup> It's harnessed to a robust 5-speed manual transmission that shifts smoothly across high and low range, even when faced with testing terrain.

The iconic V8 is complemented by a new 2.8L 4-cylinder turbo diesel engine with a 6-speed automatic transmission.

Offering a V8 rivalling 150kW of power at 3,400rpm and a massive 500Nm of torque from 1,600-2,800rpm, this impressive new heavy-duty powertrain has proven its toughness and reliability in other Toyota 4WDs.

The new 4-cylinder turbo diesel engine equals or exceeds the V8's stump-pulling torque output from 1400-3400rpm, and enhances both fuel efficiency, overall performance and driveability in all conditions, even when towing. It unleashes the capability to keep LandCruiser exploring for longer.

With 180L fuel tanks available on the Troop Carrier, and a 130L tank on all other models, you're sure to go a long way in LandCruiser 70 Series.



# Toyota Safety Sense

Toyota  
Safety  
Sense

At Toyota, we believe it's simply not enough to say "safety comes first" – we prove it. That's why, in our ongoing pursuit of creating ever safer cars, now and into the future, we developed Toyota Safety Sense<sup>7</sup> (TSS). A suite of active safety features designed to protect us all through helping to support safe driving.

LandCruiser 70 features TSS driver assistance technologies, aiming to recognise and help avoid certain hazards and collisions, giving you and your passengers greater peace of mind wherever you're headed. Please visit [toyota.com.au](http://toyota.com.au) for vehicle and specification information.

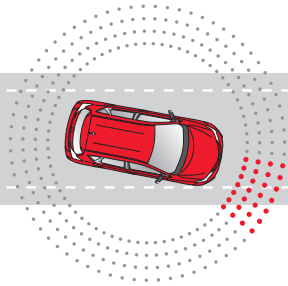

## Lane Departure Alert

Lane Departure Alert<sup>7</sup> is designed to help prevent vehicles drifting from their lane, by monitoring road markings, and providing a visible and audible alert should it detect any deviation from the lane.

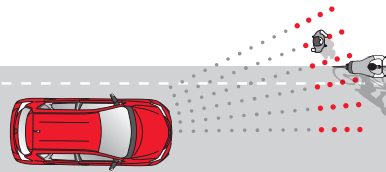

## Pre-Collision Safety (PCS) system with pedestrian and daytime cyclist detection

Pre-Collision Safety<sup>7</sup> (PCS) system with pedestrian and daytime cyclist detection is a multi-stage warning system. Using an integrated camera and radar to help detect other vehicles in front of you, the PCS system is designed to assist the driver where there is a likelihood of frontal collision with cars and pedestrians during day or night, or cyclists during the day time. The PCS system includes a visible and audible alert of possible collisions, additional braking force to assist when you're braking, and if a collision appears to be unavoidable automatic braking to help mitigate impact.

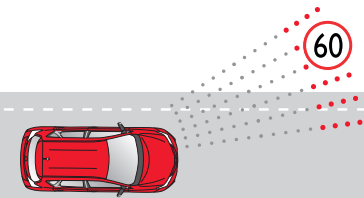

## Road Sign Assist (speed signs only)

Road Sign Assist<sup>7</sup> was developed to help recognise certain road speed signs and provide information to you. It displays the most recently recognised speed limit on the Multi Information Display.

# Single-Cab Cab-Chassis



## WorkMate

- 4.5L V8 turbo diesel engine
  - 5-speed manual transmission
- 2.8L 4 cylinder diesel engine
  - 6-speed automatic transmission
- 130L fuel tank
- 16" steel wheels
- Steel side steps
- Black front bumper and exterior mirrors
- Tilt and telescopic steering column
- Engine immobiliser
- Downhill Assist Control – auto only
- LED headlamps

- LED Daytime Running Lights
- Manual headlamp levelling
- Automatic High Beam
- Cruise control
- Active Traction Control
- Anti-lock Braking System
- 2-speaker audio with manual antenna, Bluetooth<sup>®2,3</sup> and MP3 compatibility
- 6.7" colour touchscreen display
- Apple CarPlay<sup>®1</sup> and Android Auto<sup>™1</sup>
- 12V accessory connector
- USB charging and multimedia port<sup>2</sup>

- Toyota Safety Sense<sup>7</sup> – including Lane Departure Alert, Pre-Collision Safety system with pedestrian detection and daytime cyclist detection and Road Sign Assist (speed signs only)

## GX – In addition to, or in replacement of, WorkMate features:

- 16" alloy wheels
- Over-fender flares
- Front mudguards – wide
- Differential locks – optional

## GXL – In addition to, or in replacement of, GX features:

- Chrome painted front bumper
- Aluminium side steps
- Power windows
- Central locking
- Variable intermittent wipers
- Differential locks
- Carpet flooring and cloth seats
- USB charging and multimedia port<sup>2</sup>
- LED front fog lamps

Single-Cab Cab-Chassis GXL model in Silver Pearl<sup>7</sup> shown with optional Toyota Genuine tray body and under body tyre hanger<sup>9</sup> – sold separately

# Double-Cab Cab-Chassis



## WorkMate

- 4.5L V8 turbo diesel engine
  - 5-speed manual transmission
- 2.8L 4 cylinder diesel engine
  - 6-speed automatic transmission
- 130L fuel tank
- 16" steel wheels
- Aluminium side steps
- Black front bumper and exterior mirrors
- Tilt and telescopic steering column
- Engine immobiliser
- Cruise control
- Active Traction Control

- Downhill Assist Control – auto only
- LED headlamps
- LED Daytime Running Lamps
- Manual headlamp levelling
- Automatic High Beam
- Anti-lock Braking System
- 2-speaker audio with manual antenna, Bluetooth<sup>®2,3</sup> and MP3 compatibility
- 6.7" colour touchscreen display
- Apple CarPlay<sup>®1</sup> and Android Auto<sup>™1</sup>
- 12V accessory connector
- USB charging and multimedia port<sup>2</sup>
- Toyota Safety Sense<sup>7</sup> including Lane Departure Alert, Pre-Collision Safety system with pedestrian detection and daytime cyclist detection and Road Sign Assist (speed signs only)

## GXL – In addition to, or in replacement of, WorkMate features:

- 16" alloy wheels
- Over-fender flares
- Chrome and painted front bumper
- Front mudguards – wide
- LED front fog lamps

- Power windows
- Differential locks
- Central locking
- Variable intermittent wipers
- Carpet flooring and cloth seats
- USB charging and multimedia port<sup>2</sup>

# Wagon



## WorkMate

- 2.8L 4 cylinder diesel engine – 6-speed automatic transmission
- 130L fuel tank
- 16" steel wheels
- Aluminium side steps
- Black front and rear bumper, and exterior mirrors
- Tilt and telescopic steering column
- Engine immobiliser
- Cruise control
- Front and rear mudguards
- Active Traction Control
- Anti-lock Braking System

- 6.7" colour touchscreen display
- 4 speaker audio with manual antenna, Bluetooth<sup>®2,3</sup> and MP3 compatibility
- Apple CarPlay<sup>®1</sup> and Android Auto<sup>™1</sup>
- 12V accessory connector
- Downhill Assist Control – auto only
- LED headlamps
- LED Daytime Running Lamps
- Manual headlamp levelling
- Automatic High Beam
- Reverse camera
- USB charging and multimedia port<sup>2</sup>

- All weather floor mats – front and rear
- Toyota Safety Sense<sup>7</sup> – including Lane Departure Alert, Pre-Collision Safety system with pedestrian detection and daytime cyclist detection and Road Sign Assist (speed signs only)

## GXL – In addition to, or in replacement of, WorkMate features:

- 4.5L V8 turbo diesel engine – 5-speed manual transmission
- 16" alloy wheels

- Over-fender flares
- Front mudguards – wide
- Chrome and painted front and rear bumpers
- LED front fog lamps
- Power windows
- Central locking
- Differential locks
- Carpet flooring and cloth seats
- USB charging and multimedia port<sup>2</sup>

# Troop Carrier



## WorkMate

- 4.5L V8 turbo diesel engine
  - 5-speed manual transmission
- 2.8L 4 cylinder diesel engine
  - 6-speed automatic transmission
- 180L capacity fuel tanks
- 16" steel wheels
- Steel side steps
- Front and rear mudguards
- Black front and rear bumper, and exterior mirrors
- Tilt and telescopic steering column
- Engine immobiliser
- Downhill Assist Control – auto only
- LED headlamps
- LED Daytime Running Lamps
- Manual headlamp levelling
- Automatic High Beam
- Cruise control
- Active Traction Control
- Anti-lock Braking System
- 2 speaker audio with manual antenna, Bluetooth<sup>®2,3</sup> and MP3 compatibility
- 6.7" colour touchscreen display
- Apple CarPlay<sup>®1</sup> and Android Auto<sup>™1</sup>
- USB charging and multimedia port<sup>2</sup>
- 12V accessory connector

- Toyota Safety Sense<sup>7</sup> – including Lane Departure Alert, Pre-Collision Safety system with pedestrian detection and daytime cyclist detection and Road Sign Assist (speed signs only)

## GXL – In addition to, or in replacement of, WorkMate features:

- Chrome and painted front and rear bumpers
- LED front fog and driving lamps
- Aluminium side steps
- Front power windows

- Central locking
- Variable intermittent wipers
- Differential locks
- Carpet flooring – front
- Vinyl flooring – rear
- Cloth seats
- USB charging and multimedia port<sup>2</sup>



Single Cab Cab Chassis GXL model in Merlot Red<sup>7</sup> shown with optional Toyota Genuine tray body and under body tyre hanger<sup>8</sup> - sold separately



# Land your perfect colour

From the red centre, to the bush or down by the sea, the colours of Australia are wonderfully vibrant and varied. And so are the seven knockout colours<sup>6</sup> for LandCruiser 70 Series, ready for you to blend in or standout from your chosen terrain.

## COLOUR AND TRIM GUIDE<sup>6</sup>

Model	Grade	Interior Seat Trim	French Vanilla	Silver Pearl <sup>7</sup>	Graphite <sup>7</sup>	Merlot Red <sup>7</sup>	Sandy Taupe	Midnight Blue	Eclipse Black
Single-Cab Cab-Chassis	WorkMate	Grey vinyl (LB10)	•	•	•	•	•	•	
	GX	Grey vinyl (LB10)	•	•	•	•	•	•	
	GXL	Grey fabric (FB10)	•	•	•	•	•	•	
Double-Cab Cab-Chassis	WorkMate	Grey vinyl (LB10)	•	•	•	•	•	•	
	GXL	Grey fabric (FB10)	•	•	•	•	•	•	
Troop Carrier	WorkMate	Grey vinyl (LB10)	•				•	•	
	GXL	Grey fabric (FB10)	•				•	•	
Wagon	WorkMate	Grey vinyl (LB10)	•	•	•	•	•	•	•
	GXL	Grey fabric (FB10)	•	•	•	•	•	•	•



○ French Vanilla 058



○ Silver Pearl<sup>7</sup> 1F7



● Graphite<sup>7</sup> 1G3



● Merlot Red<sup>7</sup> 3Q3



● Sandy Taupe 4E9



● Midnight Blue 8H6



● Eclipse Black 218

# Accessories for every situation

Whether you're loading the tray at work, or towing<sup>8</sup> your caravan on the weekend, know that Toyota Genuine Accessories<sup>9</sup> are designed to fit your LandCruiser 70.

Our development program aims to ensure that the accessories are made to work with the vehicle as part of an integrated system, with many components developed years before vehicle launch. With an accessories range tested for performance in the rugged Australian conditions and backed by our Toyota Warranty,<sup>10</sup> you can kit up your vehicle to meet the demands of your lifestyle.

So, roll up your sleeves and make your LandCruiser 70 ready for the journey ahead with Toyota Genuine Accessories.

To find out more, go to: [toyota.com.au/landcruiser-70/accessories](https://toyota.com.au/landcruiser-70/accessories)



Double-Cab Cab-Chassis GXL in Sandy Taupe model shown accessorised with Steel Bull Bar (requires additional Bracket Kit) and Side Rails in Sandy Taupe, LED Light Bar (requires additional Light Bar Harness and Mounting Kit), Bonnet Protector, Headlamp Covers, Front Weathershield, Heavy Duty Steel Tray in Sandy Taupe, Load Distribution Hitch, Tow Bar, Tow Ball and Trailer Wiring Harness. Accessories each sold separately.<sup>9</sup>

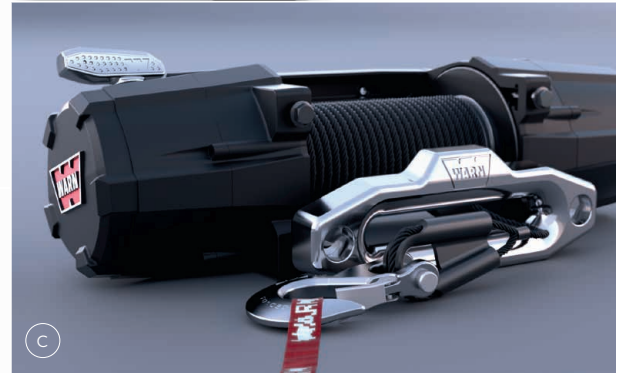

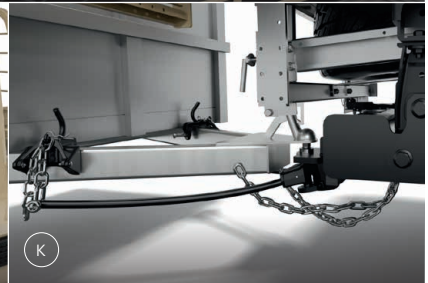

- A Steel bullbar – also available in matching vehicle exterior colour
- B Side rails – also available in matching vehicle exterior colour, steel bullbar sold separately
- C Winch – lightweight synthetic rope winch shown
- D Headlamp covers
- E Tow bar, tow ball and trailer wiring harness – each sold separately

- F Alloy roof tray – roof racks sold separately
- G Heavy duty roof racks – 3-bar set also available
- H Canvas seat covers
- I Bonnet protector
- J Front weathershields – each sold separately
- K Load Distribution Hitch – Tow bar, tow ball and trailer wiring harness sold separately

# Unlock it all



When you join the Toyota family, you get so much more than a new car feeling. You unlock a whole range of benefits to keep you moving now and well into the future.

Discover your Toyota lifetime of advantages at [toyota.com.au/owners](https://toyota.com.au/owners)

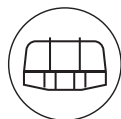

## Toyota Genuine Accessories<sup>9</sup>

Developed alongside the vehicle, this unique advantage allows Toyota to design accessories, so they integrate harmoniously with the vehicle structure and safety systems. For more information, visit [toyota.com.au/accessories](https://toyota.com.au/accessories)



## Toyota Service Advantage<sup>11</sup>

We'll keep the cost of your standard logbook service at a capped price for up to your first 3 or 5 years on the road, depending on the vehicle model. To find out your low capped service price, visit [toyota.com.au/owners/service/service-pricing-calculator](https://toyota.com.au/owners/service/service-pricing-calculator)



## Toyota Genuine Insurance<sup>12</sup>

With Toyota Genuine Insurance you're not alone. Over 350,000\* Toyota owners have made the same choice because they know their Toyota's in safe hands. For more information, visit [toyotainsurance.com.au](https://toyotainsurance.com.au)



## Toyota Access

Offering flexible finance options, lower monthly repayments<sup>13</sup> and a Guaranteed Future Value,<sup>14</sup> a Toyota Access Loan means you can drive the Toyota you want today, knowing the future is taken care of. When your loan ends, you have options to trade, keep or return your vehicle. For more information, visit [toyota.com.au/toyota-access](https://toyota.com.au/toyota-access)



## Toyota Certified Pre-Owned Vehicles

Enjoy the reassurance that comes with a Toyota Certified Pre-Owned Vehicle. Including an additional 1-year Toyota-backed warranty,<sup>15</sup> full-service history and 90-point inspection by Toyota Technicians. For more information, visit [toyota.com.au/certified](https://toyota.com.au/certified)



## Toyota Warranty Advantage<sup>16</sup>

Stick to your service schedule, and we'll extend your engine and driveline warranty from five to seven years, so you can drive stress-free for longer. For more information, visit [toyota.com.au/owners/warranty](https://toyota.com.au/owners/warranty)

# Disclaimers and Notice

- 1 CarPlay® is a trademark of Apple, Inc. registered in the U.S. and other countries. Android Auto™ is a trademark of Google LLC.
- 2 Compatibility and functionality varies depending on device.
- 3 Bluetooth® is a registered trademark of Bluetooth SIG, Inc.
- 4 Troop Carrier and Wagon GXL also come standard with vinyl rear flooring.
- 5 Driver assist feature. Only operates under certain conditions. Check your Owner's Manual for explanation of limitations. Please drive safely.
- 6 Toyota Australia reserves the right to vary or discontinue the current interior and exterior colours, trims and colour/trim/model combinations. Colours and trims displayed are a guide only and may vary from actual colours due to printing/display process. See your Toyota Dealer to confirm availability when ordering your vehicle.
- 7 Paint featured is optional extra at additional cost.
- 8 Towing capacity subject to regulatory requirements, and vehicle and equipment design limitations. Ask your dealer for more information, including Toyota Genuine Tow Bar capacity and availability. Check vehicle towing capacity before attaching loads.
- 9 See your Toyota Dealer to confirm Toyota Genuine Accessories suitable for your vehicle prior to ordering, as specifications, applicability, availability and fitment requirements may change over time. Consider combined mass of load and accessories to ensure gross vehicle mass limits are not exceeded. Refer to [toyota.com.au/vehiclepayload](https://toyota.com.au/vehiclepayload) for information. Fitment of certain accessories may require recalibration, relocation or removal of standard equipment (which may be retained by Toyota). Toyota Australia uses its best endeavours to ensure material is accurate at the time of publishing. Colours depicted are a guide only and may vary from actual due to the print/display process. Toyota Australia reserves the right to change and/or discontinue, without notice, prices, colours, materials, equipment and specifications. To the extent permitted by law, Toyota Australia will not be liable for any damage or loss incurred from relying on the information and images contained in this material. Distributed nationally (other than in Western Australia) by Toyota Motor Corporation Australia Limited ABN 64 009 686 097. Material distributed in Western Australia by or on behalf of Prestige Motors Pty Ltd (for vehicles) and by Eastpoint Pty Ltd (for parts/ accessories). Toyota Australia makes no warranties regarding (and will not be liable for) accuracy of materials distributed in Western Australia. Proof: T2023-000139.
- 10 Toyota Genuine Parts/Accessories purchased at and fitted by a Toyota Dealer to a Toyota vehicle which was purchased on or after 01/01/2019, are warranted for the remainder of that vehicle's Toyota Warranty Advantage period, or 2yrs from installation (whichever is greater). Genuine Parts/Accessories purchased from, but not fitted by, a Toyota Dealer are warranted for 2yrs from date of purchase. See [toyota.com.au](https://toyota.com.au) for T&Cs. This warranty does not limit and may not necessarily exceed your rights under the Australian Consumer Law.
- 11 Standard scheduled logbook services only. T&Cs apply. Visit [toyota.com.au/advantage](https://toyota.com.au/advantage)
- 12 Terms and conditions apply. This advice is general in nature and does not take into account your objectives, financial situation or needs. Before making a decision to purchase any of the insurance products you should consider the appropriateness of the advice taking into account your own objectives, financial situation and needs and refer to the current PDS and Target Market Determination for the relevant product available from participating Dealers, via our website at [toyotainsurance.com.au](https://toyotainsurance.com.au) or by calling 137 200. Toyota Car Insurance purchased in a dealership or via the Toyota Insurance National Customer Solutions Centre is facilitated by Toyota Finance Australia Limited ABN 48 002 435 181, AFSL and Australian Credit Licence 392536 as agent for, and on behalf of, the insurer. The insurer of Toyota Car Insurance is Aioi Nissay Dowa Insurance Company Australia Pty Ltd ABN 11 132 524 282, AFSL 443540 (Adica). If Toyota Car Insurance is purchased online, the issuer and insurer is Adica. \*This figure represents the total number of Toyota vehicles that have been insured by Toyota Insurance as at November 2021.
- 13 Lower monthly repayments compared to a similar term with no Guaranteed Future Value (GFV) or equivalent balloon final payment. Total interest charges will be higher if a GFV or balloon final payment is selected.
- 14 Guaranteed Future Value (GFV) is the minimum value of your new or approved demonstrator Toyota at the end of your finance contract, as determined by Toyota Finance subject to fair wear and tear and agreed kilometres being met. Ask your Dealers for more information. Approved applicants only. T&Cs apply. Toyota Finance Australia Limited ABN 48 002 435 181, AFSL and Australian Credit Licence 392536.
- 15 Applicable to pre-owned vehicles purchased as a Toyota Certified Pre-Owned (TCPO) vehicle on or after 01/01/2022. TCPO 2022 Warranty expires 1 year after sale, or 1 year after the current New Vehicle Warranty expires (if applicable), or 10 years from date of registration in original owner's name, or at 160,000kms (whichever occurs first). TCPO Warranty does not apply to vehicles used for commercial purpose (eg taxis or rideshare). See [toyota.com.au/tcpowarranty](https://toyota.com.au/tcpowarranty) for T&Cs. This warranty does not limit and may not necessarily exceed your rights under the Australian Consumer Law.
- 16 The standard Toyota Warranty Advantage period is 5yrs, with unlimited kms, from delivery. Excludes vehicles used for a commercial purpose, such as taxis, hire vehicles and vehicles transporting people or goods for payment including rideshare. The commercial vehicle Toyota Warranty Advantage period is 5 years from delivery or 160,000kms (whichever occurs first). See [toyota.com.au/owners/warranty](https://toyota.com.au/owners/warranty) or your vehicle's Warranty and Service Book for T&Cs. This warranty does not limit and may not necessarily exceed your rights under the Australian Consumer Law.

## IMPORTANT NOTICE – PLEASE READ:

Toyota Australia uses its best endeavours to ensure material is accurate at the time of publishing. All information must be confirmed with your Toyota Dealer at the time of ordering, as specifications, applicability and availability may change over time. Colours depicted are a guide only and may vary from actual colours due to the printing/display process. Toyota Australia reserves the right to change and/or discontinue, without notice, models, prices, colours, materials, equipment, specifications. To the extent permitted by law, Toyota Australia will not be liable for any damage or loss incurred from relying

on the information and images contained in this material. Distributed nationally (other than in Western Australia) by Toyota Motor Corporation Australia Limited ABN 64 009 686 097. Material distributed in Western Australia by or on behalf of Prestige Motors Pty Ltd (for vehicles) and by Eastpoint Pty Ltd (for parts/accessories). Toyota Australia makes no warranties regarding (and will not be liable for) accuracy of materials distributed in Western Australia. PROOF HQ: T2023-020677. GTO-007353-00. VERSION: NOVEMBER 2023.