

V60/S60 Specifications - Model Year 2023

V O L V O

	S60 B5 Ultimate Bright	V60 Cross Country B5 Ultimate
Technical Specifications		
Powertrain	B5 AWD Mild Hybrid	
Engine / Motor	Four-cylinder turbocharged engine	
Drive	All-Wheel Drive	
Displacement	1,969cc	
Transmission	Automatic 8-speed	
Power	183kW at	
Torque	350Nm at	
Acceleration 0-100km/h, seconds	6.5	6.9
Fuel Economy, l/100km*	7.2	7.4
CO2, g/km*	165	168
CO2, g/km (converted to 3P-WLTP)	184	187
Tare Weight, kg	1,849	1,808
Towing Capacity, kg	1,800	1,800
Fuel Tank, litres	60	
Country of Origin	Daqing, China	Gent, Belgium
Dimensions		

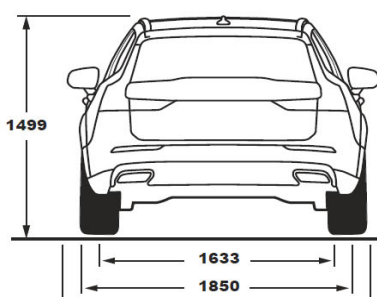
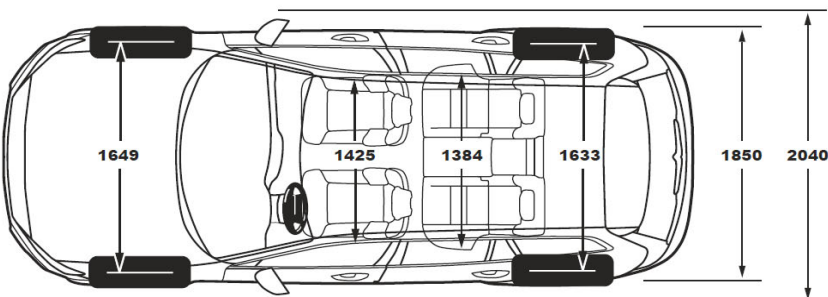
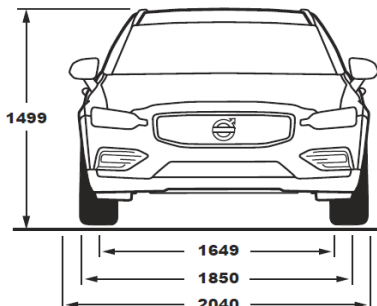
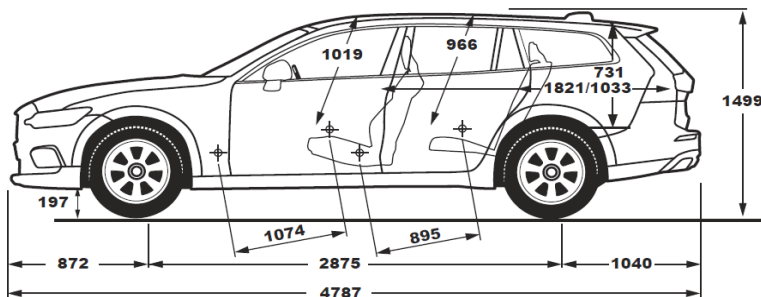
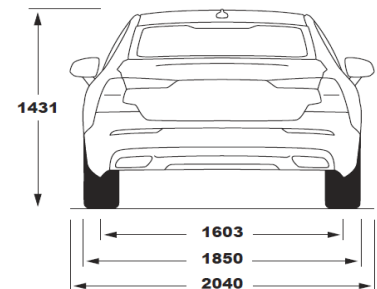
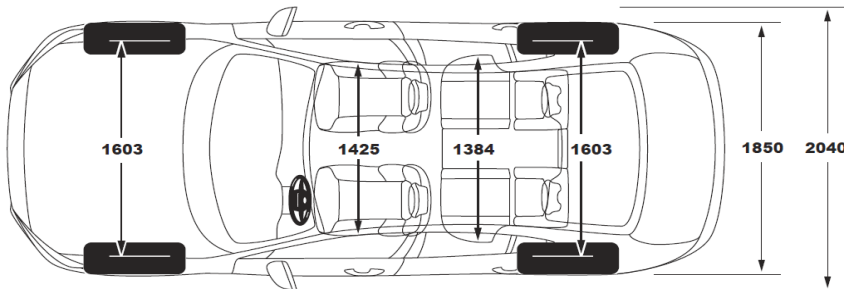
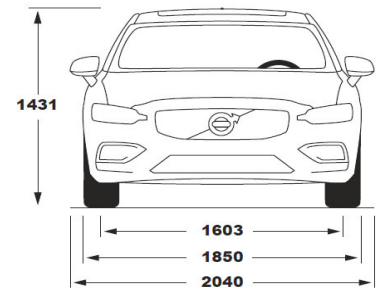
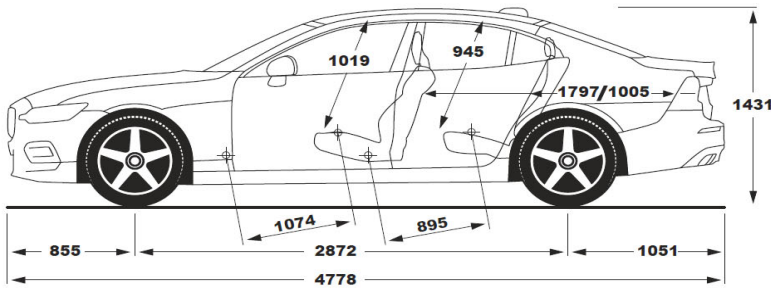

September 2022 - Model Year 2023

All pricing shown does not include on-road costs and clean car fees unless specified otherwise. For more information visit 'Car Configurator' on the Volvo Car New Zealand website.

The price of the car includes access to the following digital services for a period of 4 years: Google Assistant, Google Maps, Google Play Store, the Volvo Car App remote functions and data for the said services. After that period a prolongment or renewal will be offered, a subscription fee will in such case be added.

Information is correct at the time of printing, however the manufacturer reserves the right to make changes without notice. Please confirm model availability, specification and pricing details with your Volvo dealer. Accessories and / or options fitted to vehicles may affect vehicle performance, range, fuel consumption and emissions.

*Figures according to ADR/NEDC are derived from laboratory testing. Factors including but not limited to driving style, road and traffic conditions, environmental influences, vehicle condition and accessories fitted, means in the real world the range you experience can differ from that advertised. Advertised figures are meant for comparison purposes.

S Standard | NCO No cost option | - Not available | P Pack

V60/S60 Specifications - Model Year 2023



	S60 B5 Ultimate Bright	V60 Cross Country B5 Ultimate
Safety		
Airbag, Driver & Passenger	S	S
Side Impact Protection System Airbags	S	S
Inflatable Curtain Airbags	S	S
Front Seat Whiplash protection	S	S
Pyrotechnical pretensioners, front / rear all positions	S	S
Isofix - outer position rear seat	S	S
Flashing Emergency Brake Light and Hazard Warning	S	S
Support System		
Adjustable speed limiter	S	S
Adaptive Cruise Control	S	S
Collision Mitigation Support, front	S	S
Pilot Assist	S	S
Lane Keeping Aid	S	S
Blind spot Information System with Cross traffic alert	S	S
Collision Warning and Mitigation support, rear	S	S
360° Camera	S	S
Parking assistance Gen3, front, rear & side	S	S
Personal settings, power steering	S	S
Hill start assist	S	S
Hill Descent Control	S	S
Rainsensor	S	S
Graphical Head Up Display	S	S
Audio & Navigation		
High Performance Sound	S	S
Premium Sound by Bowers and Wilkins (553)	\$4,500	\$4,500
Harman Kardon Premium Sound (1033)	\$1,200	\$1,200
Digital Service, 4 years subscription standard	S	S
Road Sign Information (RSI)	S	S
Remote control buttons in steering wheel	S	S
2 USB Typ-C Connectors	S	S
Bluetooth connection	S	S
Apple Carplay (Wired)	S	S
Volvo On Call	S	S
Digital Audio Broadcasting, DAB	S	S
Speech function	S	S
Inductive Charging for smartphone	S	S
Climate		
Electronic Climate Control, 4 zone	S	S
CleanZone	S	S
Air purifier with Particulate Matter Sensor, aka PM2.5-sensor	S	S
Humidity sensor	S	S
Preventilation + prolonged heating after engine shut off	S	S
Tinted windows, rear side doors and cargo area (179)	-	\$600
Panoramic sun roof with power operation (30)	S	\$2,700
Windscreen washers (Aquablades)	S	S
Heated steering wheel	S	S
Locking and security systems		
Alarm with interior motion sensor	S	S
Key remote	S	S
Keyless entry and start	S	S
Private locking	S	S
Central lock switch with diode in front doors	S	S
Tempered glass, side and rear windows	S	S
Power child lock, rear side doors	S	S

September 2022 - Model Year 2023

All pricing shown does not include on-road costs and clean car fees unless specified otherwise. For more information visit 'Car Configurator' on the Volvo Car New Zealand website.

The price of the car includes access to the following digital services for a period of 4 years: Google Assistant, Google Maps, Google Play Store, the Volvo Car App remote functions and data for the said services. After that period a prolongment or renewal will be offered, a subscription fee will in such case be added.

Information is correct at the time of printing, however the manufacturer reserves the right to make changes without notice. Please confirm model availability, specification and pricing details with your Volvo dealer. Accessories and / or options fitted to vehicles may affect vehicle performance, range, fuel consumption and emissions.

*Figures according to ADR/NEDC are derived from laboratory testing. Factors including but not limited to driving style, road and traffic conditions, environmental influences, vehicle condition and accessories fitted, means in the real world the range you experience can differ from that advertised. Advertised figures are meant for comparison purposes.

S Standard | NCO No cost option | - Not available | P Pack

V60/S60 Specifications - Model Year 2023

V O L V O

	S60 B5 Ultimate Bright	V60 Cross Country B5 Ultimate
Luggage compartment		
Temporary sparewheel with Jack	S	S
Power Operated Tailgate with handsfree opening	S	-
Power Operated Tailgate with handsfree opening/closing	-	S
Load cover	-	S
12V Power outlet, luggage area	S	S
Interior upholstery		
Moritz Leather Accented (RA00) Front Row Only, includes: Charcoal Interior, Crystal Gearknob, Blond Headlining, Charcoal Carpets, Charcoal Tunnel, Charcoal Door Inserts, Charcoal Colour Accent, Metal Mesh Decor, Artificial Leather steering wheel with Uni deco (charcoal)	S	S
Moritz Leather Accented (UA00) Front Row Only, includes: Blond/Charcoal Interior, Crystal Gearknob, Blond Headlining, Charcoal Carpets, Blond Tunnel, Blond Door Inserts, Blond Colour Accent, Drift Wood Decor, Leather accented steering wheel with Uni deco	-	NCO
Ventilated/Perforated Nappa Leather Accented (RC00) Front Row Only, includes: Charcoal Interior, Crystal Gearknob, Blond Headlining, Charcoal Carpet, Charcoal Tunnel, Charcoal Door Insert, Charcoal Accent Colour, Drift Wood Decor, Artificial Leather steering wheel with Uni deco	\$3,600	\$3,600
Ventilated/Perforated Nappa Leather Accented (UC00) Front Row Only, includes: Blond/Charcoal Interior, Crystal Gearknob, Blond Headlining, Charcoal Carpet, Blond Tunnel, Blond Door Insert, Blond Accent Colour, Drift Wood Decor Inlay, Leather accented steering wheel with Uni deco	-	\$3,600
Seats		
Power adjustable driver and front passenger seat with memory	S	S
Power adjustable side support, standard with xCx0 upholstery codes	O	O
Backrest massage, front seats (000384) only optional with xCx0 upholstery codes	-	\$2,100
Heated front seats	S	S
Heated rear seats	S	S
Mechanical release fold 2nd row rear seat	-	S
Power folding rear headrests	-	S
Centre rear armrest with cupholders	S	S
Cushion extension (front seats only)	S	S
Interior		
Illuminated vanity mirrors in sunvisor LH / RH side	S	S
Parking ticket holder	S	S
Tailored Instrument Panel	S	S
Gearlever knob, crystal	S	S
Interior illumination high level	S	S
Exterior		
Colour coordinated door handles with Illumination and Puddle lights	S	S
Retractable Rear View Mirrors	S	S
Roof rails	-	S
Wheel arch mouldings	-	S
Foglights in front	S	S
LED Headlights Bending	S	S

September 2022 - Model Year 2023

All pricing shown does not include on-road costs and clean car fees unless specified otherwise. For more information visit 'Car Configurator' on the Volvo Car New Zealand website.

The price of the car includes access to the following digital services for a period of 4 years: Google Assistant, Google Maps, Google Play Store, the Volvo Car App remote functions and data for the said services. After that period a prolongment or renewal will be offered, a subscription fee will in such case be added.

Information is correct at the time of printing, however the manufacturer reserves the right to make changes without notice. Please confirm model availability, specification and pricing details with your Volvo dealer. Accessories and / or options fitted to vehicles may affect vehicle performance, range, fuel consumption and emissions.

*Figures according to ADR/NEDC are derived from laboratory testing. Factors including but not limited to driving style, road and traffic conditions, environmental influences, vehicle condition and accessories fitted, means in the real world the range you experience can differ from that advertised. Advertised figures are meant for comparison purposes.

S Standard | NCO No cost option | - Not available | P Pack

V60/S60 Specifications - Model Year 2023



	S60 B5 Ultimate Bright	V60 Cross Country B5 Ultimate
Exterior Colours - Solid		
Black Stone (019)	-	S
Exterior Colours - Metallic/Pearl		
Onyx Black (717)	S	NCO
Crystal White (707)	NCO	
Denim Blue (723)		
Fusion Red (725)		
Thunder Grey (728)		
Platinum Grey (731)		
Silver Dawn (735)		
Bright Dusk (736)		
Lifestyle Package with Harmon Kardon		
Panoramic Sunroof (30)	-	\$3,000
Premium Sound System - Harman Kardon (1033)	-	
Lifestyle Package with Bowers and Wilkins		
Panoramic Sunroof (30)	-	\$5,900
Premium Sound System - Bowers and Wilkins (553)	-	
Standard Wheels		
19" 5-Open Spoke Black Diamond-cut Alloy wheel	S	-
19" 5-Double Spoke Matt Graphite Diamond-cut Alloy wheel	-	S
Tyres		
235/40R19	S	-
235/45R19	-	S
Indirect Tyre Pressure Monitoring System	S	S
Option Wheels/Tyres		
20" 7-Spoke Matt Graphite Diamond-cut Alloy wheel	-	\$4,000
245/40R20	-	O

September 2022 - Model Year 2023

All pricing shown does not include on-road costs and clean car fees unless specified otherwise. For more information visit 'Car Configurator' on the Volvo Car New Zealand website.

The price of the car includes access to the following digital services for a period of 4 years: Google Assistant, Google Maps, Google Play Store, the Volvo Car App remote functions and data for the said services. After that period a prolongment or renewal will be offered, a subscription fee will in such case be added.

Information is correct at the time of printing, however the manufacturer reserves the right to make changes without notice. Please confirm model availability, specification and pricing details with your Volvo dealer. Accessories and / or options fitted to vehicles may affect vehicle performance, range, fuel consumption and emissions.

*Figures according to ADR/NEDC are derived from laboratory testing. Factors including but not limited to driving style, road and traffic conditions, environmental influences, vehicle condition and accessories fitted, means in the real world the range you experience can differ from that advertised. Advertised figures are meant for comparison purposes.

S Standard | NCO No cost option | - Not available | P Pack