

Crafter 50 Van

Model Year 2023 Specifications



Commercial Vehicles



5 YEAR WARRANTY

Price	Crafter 50 MWB	Crafter 50 LWB	Crafter 50 ELWB
Model Code	SYBD8D	SYCD8D	SYDD8D
Maximum Retail Price* - 8 Speed Automatic	\$100,000	\$104,000	\$106,500
Manual Transmission (Indent Order Only)	-\$4,000	-\$4,000	-\$4,000

*Maximum Retail Price (MRP) includes 15% GST and does not include on-road costs. Fuel consumption tested in accordance with EC directive EEC 715/2007 and is based on NEDC procedure. Consumption is measured on European specification cars and may vary depending on equipment, road conditions, tires and driving behaviour. Image shows international specification, local specification may vary. Specifications are as planned at June 2023 for Model Year 2023 and subject to change without notice or obligation.



Technical Data	Crafter 50 MWB	Crafter 50 LWB	Crafter 50 ELWB
Engine Type	4-Cylinder Twin Turbo	4-Cylinder Twin Turbo	4-Cylinder Twin Turbo
Fuel Type	Diesel	Diesel	Diesel
Cubic Capacity (cc)	1,968	1,968	1,968
Maximum Power (kW) @ rpm	130 @ 3,600	130 @ 3,600	130 @ 3,600
Maximum Torque (Nm) @ rpm	410 @ 1,500 - 2,000	410 @ 1,500 - 2,000	410 @ 1,500 - 2,000
Drivetrain	Rear Wheel Drive	Rear Wheel Drive	Rear Wheel Drive
Gross Vehicle Mass (kg)	5,000	5,000	5,000
Tare weight (kg), based on Standard Equipment	2,583	2,704	2,773
Payload, based on Standard Equipment	2,417	2,296	2,227
Axle load limit, Front / Rear (kg)	2,200 / 3,500	2,200 / 3,500	2,200 / 3,500
Trailer load limit 12% gradient. Braked / Unbraked (kg), based on Standard Equipment	3,500 / 750	3,500 / 750	3,500 / 750
Trailer down ball force (kg)	120	120	120
Roof load limit (kg)	150	150	150
Gross Train Weight 12% gradient (kg)	8,000	8,000	8,000
Fuel Tank Capacity (L, approx.)	75	75	75
Emission Standard. NEDC	EU6	EU6	EU6
Ad Blue Tank Capacity (L, approx)	18	18	18
Combined Fuel Consumption, L/100km. NEDC	8.7	8.7	8.8
Start/stop system with regenerative braking	●	●	●
5-Year / 250,000 km (whichever occurs first) mechanical warranty, 5-Year Volkswagen Roadside Assistance	●	●	●
12-Year Anti-Corrosion Warranty	●	●	●
Up to 30,000km or every two years (whichever occurs first) oil service intervals	●	●	●
Volkswagen Service Plan - Scheduled Servicing for 4 Years / 60,000km (whichever occurs first)	\$1,595	\$1,595	\$1,595
Volkswagen Service Plan - Scheduled Servicing for 6 Years / 90,000km (whichever occurs first)	\$2,745	\$2,745	\$2,745

Crafter 50/55 Delivery Van medium wheelbase with normal roof

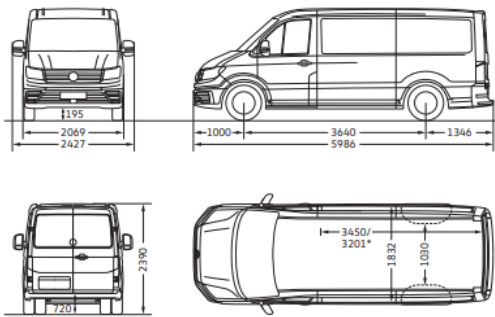

*Load compartment length, max. (at floor level)/load compartment length, min.

load compartment, height (mm)	1,626
load compartment, volume (m ³)	9.3
lateral sliding door, width x height (mm)	1,311 x 1,487
rear wing doors, width x height (mm)	1,552 x 1,505

Crafter 50/55 Delivery Van medium wheelbase with high roof

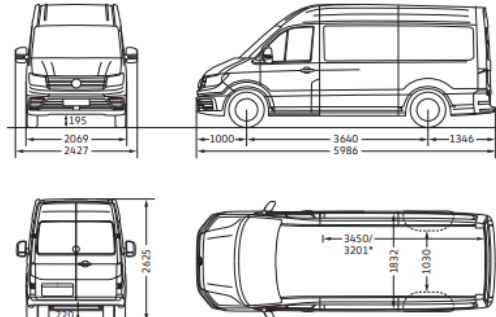

*Load compartment length, max. (at floor level)/load compartment length, min.

load compartment, height (mm)	1,861
load compartment, volume (m ³)	10.7
lateral sliding door, width x height (mm)	1,311 x 1,722
rear wing doors, width x height (mm)	1,552 x 1,740

Crafter 50/55 Delivery Van long wheelbase with high roof

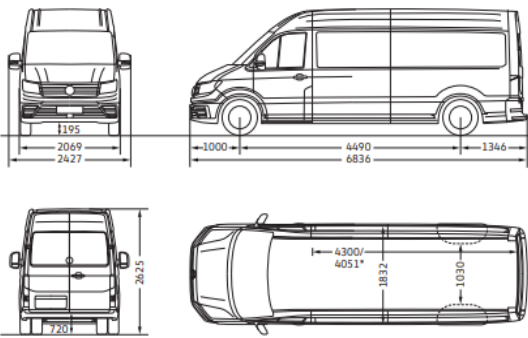

*Load compartment length, max. (at floor level)/load compartment length, min.

load compartment, height (mm)	1,861
load compartment, volume (m ³)	13.6
lateral sliding door, width x height (mm)	1,311 x 1,722
rear wing doors, width x height (mm)	1,552 x 1,740

Crafter 50/55 Delivery Van long wheelbase with super-high roof

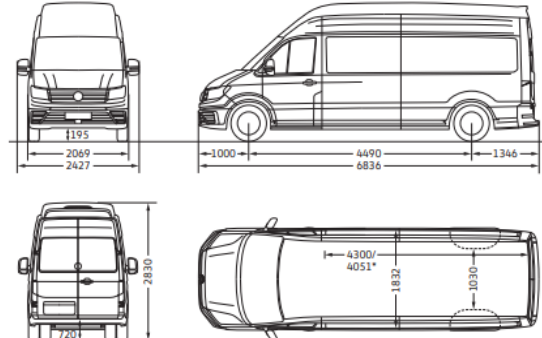

*Load compartment length, max. (at floor level)/load compartment length, min.

load compartment, height (mm)	2,089
load compartment, volume (m ³)	15.3
lateral sliding door, width x height (mm)	1,311 x 1,722
rear wing doors, width x height (mm)	1,552 x 1,740

Crafter 50/55 Delivery Van long plus wheelbase with high roof

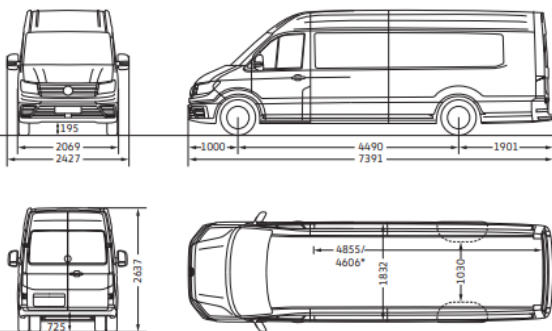

*Load compartment length, max. (at floor level)/load compartment length, min.

load compartment, height (mm)	1,861
load compartment, volume (m ³)	15.5
lateral sliding door, width x height (mm)	1,311 x 1,722
rear wing doors, width x height (mm)	1,552 x 1,740

Crafter 50/55 Delivery Van long plus wheelbase with super-high roof

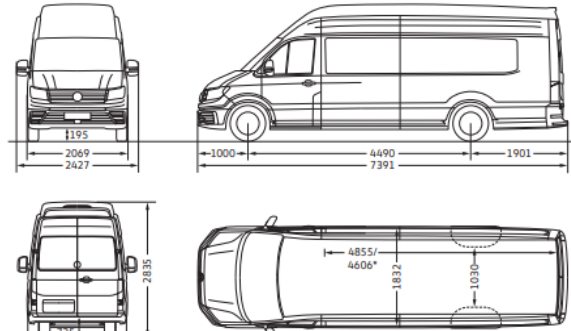

*Load compartment length, max. (at floor level)/load compartment length, min.

load compartment, height (mm)	2,096
load compartment, volume (m ³)	17.5
lateral sliding door, width x height (mm)	1,311 x 1,722
rear wing doors, width x height (mm)	1,552 x 1,740



Safety and Security		Crafter 50 MWB	Crafter 50 LWB	Crafter 50 ELWB
Driver and front passenger airbag with front passenger airbag deactivation	4UF	●	●	●
Side and Curtain Airbag for driver and front passenger (Note: Not Available with Super High Roof)	4X3	\$1,800	\$1,800	\$1,800
Forward Collision Warning Front Assist with Emergency Braking	6K2	●	●	●
Lane change system side assist with Blind Spot Monitor, electric folding mirrors and park distance control in front and rear with active side protection and rear traffic alert	ZSA	●	●	●
Cruise control system incl. speed limiter	8T6	●	●	●
Adaptive Cruise Control ACC up to 160 km/h, incl. speed limiter	8T8	\$1,250	\$1,250	\$1,250
Electronic Stability Control (ESP) and anti-lock brake system (ABS)	1AS	●	●	●
Park distance control in front and rear with active side protection	9X0	●	●	●
Park Assist with Park distance control in front and rear with active side protection	9X1	\$700	\$700	\$700
Hill Start Assist	UG1	●	●	●
Side Wind compensation	KJ1	●	●	●
Autonomous Post Collision Braking	**	●	●	●
Rear view camera system	KA1	●	●	●
3-point automatic seat belts, height-adjustable with electric seat-belt tensioners in front	3QN	●	●	●
Warning buzzer and light for driver seat belt not fastened	9P1	●	●	●
Central locking system with safe securing and radio remote control	4I2	●	●	●
Electronic vehicle immobilisation device (transponder)	7AA	●	●	●



Exterior		Crafter 50 MWB	Crafter 50 LWB	Crafter 50 ELWB
Normal Roof	3R0	-\$2,200	-	-
High Roof	3R2	●	●	●
Super High Roof (In White only)	ZD3	-	\$4,000	\$4,000
Super High Roof (In body colour)	2S2 & 7N4	-	\$5,000	\$5,000
Gross Vehicle Mass increase to 5,500kg	SY*G8D	\$5,000	\$5,000	\$5,000
Standard suspension system and shock absorption.	1BA	●	●	●
Heavy-duty suspension system and shock absorption, heavy-duty stabilizers	2MG	\$700	\$700	\$700
Grey Bumper in front with painted trim panel in body colour, radiator grille unpainted with chrome moulding	2JF & 6KA	●	●	●
Halogen twin lamps	8ID	●	●	●
LED Headlights & Daytime Running Lights	8IT	\$2,000	\$2,000	\$2,000
Heat-insulating windshield made of laminated glass	4GF	●	●	●
Heated Rear Windows	4HH	●	●	●
Windshield wiper intermittent control with light and rain sensor and separate daytime running lights with automatic headlamp activations.	ZA3	●	●	●
Exterior mirrors, power-adjustable, heated and electric folding	6XP	●	●	●
Sliding door, left and right	5Q2 & 5R2	●	●	●
Mud Flaps in Front & Rear	6N2	●	●	●
Side marker lamps	8F1	●	●	●
Rear wing doors with windows aperture	ZHF	●	●	●
Hinges for rear wing doors with increased opening angle (max. 270°)	5V4	●	●	●
Trailer hitch preparation (incl. trailer stabilisation) with wiring harness, outlet, and electronic control unit.	1D7	●	●	●



Interior		Crafter 50 MWB	Crafter 50 LWB	Crafter 50 ELWB
2 remote control folding keys	8QJ	●	●	●
Dimming breakaway interior rear-view mirror	4L2	●	●	●
Electromechanical Power Steering	**	●	●	●
Height and reach adjustable steering column	2ZA	●	●	●
Multi-function steering wheel including multi-function display "Plus". Instrument cluster with display of speed, total/trip mileage, rpm, fuel gauge, and time	2ZA & 9S5 & USA	●	●	●
Air-conditioning (Climatic) system for front cabin with semi-automatic control and outside temperature display	ZK1	●	●	●
Acoustic warning when reverse gear is engaged, de-activatable	IL2	\$500	\$500	\$500
Terminal block and preparation for function control module	IP4	●	●	●
Interior sound insulation measures, PLUS	3W3	●	●	●
Two 12V outlets in the cab (in the dashboard) and 2 beverage holders	EU1 & 9JA	●	●	●
Two 12V outlets in cab/load compartment (one at the C- and 1 at the D-pillar)	7B3	\$115	\$115	\$115
Storage compartment over cab	QE4	●	●	●
Storage compartment over cab, accessible from load compartment	7N4	\$300	\$300	\$300
Trendline Package (Four 12V outlets in cab, overhead storage compartment & reading light, chrome package, interior sound insulation measures, illuminated & lockable glove compartment, front fog lamps with cornering light, step illumination in front – de-activatable)	ZTL	\$1,300	\$1,300	\$1,300
Rubber floor covering in cab	5AC	●	●	●
Cargo area partition with fixed window	3CG	●	●	●
Cargo area partition – removal of partition (Forces: Child safety lock in load compartment, Without grab handle on B-pillar in load/passenger compartment)	ZT0	NCO	NCO	NCO
Without floor covering in passenger/load compartment, with covering for locking mechanism on tailgate/rear wing doors	5BA	●	●	●
Wooden floor covering in load compartment, with loading edge	5BD	\$1,100	\$1,100	\$1,100
Rear side trim panel in passenger/load compartment made of medium-height plastic twin-walled sheets	5DB	●	●	●
Without rear side trim panel passenger load compartment	5DA	NCO	NCO	NCO
Lashing rings for load restraint	6B1	10X	12X	14X
C-rails on side panels in load compartment	6L6	\$450	\$450	\$450
Closed side panel in load compartment, rear, left and right	4FA & 4JA	●	●	●
Closed side panel in load compartment, front, left and right	4DA & 4EA	●	●	●
Closed side panel in load compartment, centre, left and right	6VA & 6WA	●	●	●
Side window in passenger/load compartment, front left and right, fixed	4DE & 4EE	\$600	\$600	\$600
Side window in passenger/load compartment, front left and right, movable	4DM & 4EM	\$800	\$800	\$800
2 Standard interior lights in passenger / load compartment	9CC	●	●	●
Load compartment lighting: 4 LED spots	9CW	\$300	\$300	\$300



Seat & Upholstery		Crafter 50 MWB	Crafter 50 LWB	Crafter 50 ELWB
Comfort seat "Plus" for driver (Backrest adjustment, Longitudinal adjustment, 4 – track electrical lumbar support, 2x armrests, seat cushion for adjustment, height adjustment)	3SF	●	●	●
Comfort seat "Plus" for passenger	3TF	NCO	NCO	NCO
2-seater front passenger bench seat with storage compartment	3TS	●	●	●
Swivel seat for driver. Forces a fold-down hand brake. N/A with bench seat	3SD	\$300	\$300	\$300
Swivel seat for passenger	3TD	\$150	\$150	\$150
Seat trim covers in fabric "Austin"	DM - NOL	●	●	●



Minibus Package		Crafter 50 MWB	Crafter 50 LWB	Crafter 50 ELWB
Minibus Package Consists of the Following	MINIBUS	\$6,600	\$6,600	\$6,600
Air-Conditioning with 2nd Evaporator & 2nd Heater Core	6AD	●	●	●
Comfort seat "Plus" for passenger	3TF	●	●	●
Acoustic warning when reverse gear is engaged, de-activatable	IL2	●	●	●
Window Package	ZFP	●	●	●
Deep Black window tint in passenger compartment - 5% VLT	YQA	●	●	●
Cargo area partition – removal of partition (Forces: Child safety lock in load compartment, Without grab handle on B-pillar in load/passenger compartment)	ZT0	●	●	●
Interior Roof Lining	5CE	●	●	●
Rollover Protection	2Y1	●	●	●
Load compartment lighting: 4 LED spots	9CW	●	●	●
Without lashing rings	6B0	●	●	●
Side marker lamps	8F1	●	●	●
Hinges for rear wing doors	5V3	●	●	●











Multimedia		Crafter 50 MWB	Crafter 50 LWB	Crafter 50 ELWB
Radio "Composition Colour" 6.5" Touchscreen, 4 Speakers	ZI4	●	●	●
Radio "Composition Media" 8.0" Touchscreen, 4 Speakers, Voice Control	ZIG	\$700	\$700	\$700
Navigation "Discover Media" 8.0" Touchscreen, 4 Speakers, Voice Control	ZI7	\$1,500	\$1,500	\$1,500
2X Type-C USB Ports, Mobile Interface	ZI4 / ZI7	●	●	●
App-Connect	9WT	●	●	●



Wheels		Crafter 50 MWB	Crafter 50 LWB	Crafter 50 ELWB
Standard Wheels		16" Steel Wheels (Dual tires in Rear)	16" Steel Wheels (Dual tires in Rear)	16" Steel Wheels (Dual tires in Rear)
Tire Size		205/75 R16	205/75 R16	205/75 R16
Spare Steel Wheel, Tool Kit & Jack	ZR8	●	●	●



Exterior Colours		Crafter 50 MWB	Crafter 50 LWB	Crafter 50 ELWB
Candy White		B4B4	●	●
Cherry Red		4B4B	●	●
Deep Black Pearlescent		2T2T	\$2,600	\$2,600
Deep Ocean Blue		0POP	●	●
Indium Grey Metallic		X3X3	\$2,600	\$2,600
Luminous Orange		E3E3	●	●
Ontario Green		V7V7	●	●
Reflex Silver Metallic		8E8E	\$2,600	\$2,600