

Accessories and Suspension

CATALOGUE AND PRICE LIST

Effective 1 May 2021



RETAIL

VOLUME 20



Warranty

Ironman 4x4 warrants the original buyer, only when purchased new via authorised Ironman 4x4 resellers and distributors, from date of retail sale and cannot be transferred. Product is warranted against defects in material or workmanship that cause the product to perform below the specified limits set by Ironman 4x4, to the extent that Ironman 4x4 will repair or replace any parts which are found to be defective.

It is at the discretion of Ironman 4x4 if a repair will be made or a replacement issued once the product has been inspected by an Ironman 4x4 representative and deemed to be a genuine warrantable claim. All warranty claims must be submitted via original purchasing store or chain, unless otherwise arranged. Proof of original purchase must be presented upon request.

PLEASE NOTE:

No Warranty Claims or Goods Returned will be accepted unless accompanied by a completed WARRANTY CLAIM / GOODS RETURN FORM.

Products may be required to be returned to Ironman 4x4 for assessment or repair. Ironman 4x4 is not responsible for postage or removal costs involved, but assistance may be considered at the discretion of Ironman 4x4 in the event of such a claim being verified.

The warranty does NOT apply where, 1) acts of neglect or misuse are evident, 2) product has been modified, 3) vehicles which are modified or not the recommended vehicle of use, 4) used in racing or competition conditions without the prior consent of Ironman 4x4, 5) used beyond the expectations of the original vehicle manufacturer.

Before installation of any product, please ensure you have received the correct parts for your application. Ordering of the correct parts is the responsibility of the buyer. Return of a product in an unused condition will attract a 15% restock fee, where Ironman 4x4 is not at fault.

Return of used or soiled product, 1) outside warranty period, 2) without fault, will result in refusal of your claim and be returned at buyer's expense. Damage to products through fitment error is not covered under warranty.

Our goods come with statutory guarantees that cannot be excluded under Australian Consumer Law. You are entitled to a replacement or refund for a major failure and for compensation for any other reasonably foreseeable loss or damage contingent on that failure. You are also entitled to have the goods repaired or replaced if they fail to be of acceptable quality even if the failure does not amount to a major failure.

FREIGHT CONDITIONS:

Freight of all products is the buyer's responsibility. Where Ironman 4x4 have arranged freight, costs involved will be invoiced to the buyer. Ironman 4x4 is not responsible for damage or loss during freight.

FITTING:

All prices listed may be subject to fitting costs. The price of fitting is determined by the individual fitting agent.

Pricing subject to change without notice.

For further information please contact us on 1300 731 137 or email info@ironman4x4.com.

ACCESSORIES WARRANTY:

Fitment should be performed by an authorised or licensed mechanic, competent with 4x4 accessory installations. Special tools may be required when fitting some parts. Damage to products through fitment error is not covered under warranty. Warranty may become void when product is installed in conjunction with anything other than genuine manufacturer or Ironman 4x4 components.

1 YEAR	2 YEAR	5 YEAR	LIMITED LIFETIME	3 YEAR COMPONENTS, 5 YEAR COMPRESSOR
Accessories / Canopies / Mining Accessories Underbody Protection	Premium Underbody Protection	Monster Winch Snorkel	TREDS	IceCube Fridge / Freezer

SUSPENSION WARRANTY:

All suspension products must undergo a safety check at 500km after fitment. Fitment should be performed by an authorised or licensed mechanic, competent with suspension installations. Special tools may be required when fitting some parts including struts. Damage to products through fitment error is not covered under warranty. Warranty may become void when product is installed in conjunction with anything other than genuine manufacturer or Ironman 4x4 components.

Where required, Ironman 4x4 recommend wheel alignment after fitment of any new suspension component. Obtaining wheel alignments is the responsibility of the buyer.

2 YEAR	3 YEAR / 60,000 KM
Load Plus Helper Springs GVM Upgrades	Suspension

The names and reference numbers of manufacturers and suppliers other than Ironman 4x4 Pty Ltd used in this product catalogue are shown only to assist our customers in identifying replacement parts. Under no circumstances does Ironman 4x4 Pty Ltd imply that the parts sold by Ironman 4x4 are those of the OE manufacturers. Although care has been taken to ensure accuracy of data contained in this publication, Ironman 4x4 Pty Ltd does not assume any liability for errors or omissions.

©Copyright 2021 Ironman 4x4 Pty Ltd. No part of this publication may be reproduced or replicated without the prior written consent of Ironman 4x4 Pty Ltd.



4WD AND TOURING GEAR PRODUCT	
ACCESSORIES AND SUSPENSION PRODUCT BY VEHICLE	
ACCESSORY SPARE PARTS	
PRODUCT INSTALL TIMES GUIDE	
GVM UPGRADES	
SUSPENSION SELECTION INFORMATION	
SUSPENSION TECHNICAL SPECIFICATIONS	
ACCESSORY SELECTION INFORMATION	
ACCESSORY TECHNICAL SPECIFICATIONS	
PRODUCT CODE QUICK REFERENCE	

Contents - Accessories to Suit

4WD AND TOURING GEAR

RECOVERY EQUIPMENT

Electric Winches and Accessories	10
Recovery Kits, Straps and Accessories	10-11
Compressors	12
Tyre Accessories and Lifting Jacks.....	12-13
Total Traction	13
Multi-Purpose Rear Wheel Bag.....	13
Seat Covers	13

CAMPING ACCESSORIES

Camping Chairs	15
Swags	15
Sleeping Bags	15
Camp Bags	16
Toilets	16
Showers	16
First Aid	17
Camping Tools	17
Cleaning	17
Torches	18
Fans	18
Camp Lighting	18-19
Solar	19

CAMPING

Rooftop Tent	20
Rooftop Tent Accessories	20
Awning Quick Release	21
Room Enclosures.....	21
Awnings	21
Awning Xtra Weathershield	21
Instant Ensuite	21

FRIDGE / FREEZERS

Fridge / Freezers	22
Fridge Slides	22
Fridge Accessories.....	22

DRIVING LIGHTS

LED Driving Lights	23
LED Light Bars	24-25
Driving Light Accessories.....	25
Universal LED Work Lights	26
Driving and Work Light Wiring Looms.....	27

AUTO ELECTRICAL

Auto Electrical	27
Dual Battery Systems	27

STORAGE

Single Drawer Systems	28
Twin Drawer Systems	28
Wing Kits	28
Anchor Track	28
Water Tanks	29
Maxi Cases	30
Ute Boxes	30
Aluminium Tool Boxes.....	31
Steel Truck Boxes	31
Rooftop Bags	32
Rooftop Tent Hanging Bags / General Camping Bags.....	32

ROOF RACKS

Alloy Roof Racks	33
Steel Roof Racks	34
Universal Roof Rail Extrusions.....	33
Mounting Kits	34

FLEET AND MINING

Fleet and Mining Accessories.....	35
-----------------------------------	----

APPAREL

T-Shirts	36
Oilskin Jackets	36
Oilskin Vests	36

MERCHANDISE

Ironman 4x4 Merchandise	37
-------------------------------	----

ACCESSORIES TO SUIT (BY VEHICLE)

FIAT

Fullback	41
----------------	----

FORD

Everest	UAII 7/2018+.....	61
	9/2015 to 6/2018	63
Maverick	1988 to 1994 (See Nissan Patrol Page 216).....	216
Ranger	Raptor 9/2018+	44
	PX Mk III 8/2018+	46
	PX Mk II 2015 to 7/2018.....	50
	PX 7/2011 to 2015	54
	PJ / PK 2006 to 2011	58

HOLDEN / GM

Colorado	RG 11/2016 to 2020.....	74
	RG 2012 to 10/2016.....	77
	RC 7/2008 to 12/2012.....	81
Colorado 7	RG 2012+	72
Rodeo	RA7 2007 to 7/2008	83
	RA 2002 to 2006	85
Trailblazer	LT / LTZ 2017+	70

HYUNDAI

iLoad	88
-------------	----

ISUZU

D-Max	8/2019+.....	90
	2/2017 to 7/2019	93
	6/2012 to 1/2017	96
	2007 to 6/2012	100
MU-X	2014+.....	102

JEEP

Gladiator	JT 4/2019+.....	110
Grand Cherokee	WK2 2013+.....	112
Wrangler	JL 2018+	116
	JK 2007+	118

LAND ROVER

Defender	2007-2016.....	125
Discovery	Series 2, 3 and 4	130

LDV

T60	2.8L Turbo Diesel 2017+	134
-----	-------------------------------	-----

MAZDA

BT-50	6/2020+.....	139
	2012 to 5/2020	142
	J97M 2006 to 2012.....	146



Contents - Accessories to Suit

MITSUBISHI			
Pajero	NW-NX 2011	158	
	NM, NP, NS, NT 5/2000 to 2011	159	
Pajero Sport	7/2019+	154	
	11/2016 to 6/2019	156	
Triton	MR 11/2018+	170	
	MQ 2015 to 10/2018	174	
	MN 2009 to 2015	179	
	ML 2006 to 2009	182	
NISSAN			
Navara	NP300 2015+	188	
	D40 2005+	191	
	D22 2002+	194	
Pathfinder	R51 2005 to 2013	198	
Patrol	Y62 2010 to 2019	204	
	Y61 GU Series 4 2005+	206	
	Y61 GU Series 1-3 1998 to 2004	207	
	Y60 GQ Station Wagon 1987 to 1997	216	
	Y60 GQ Coil Cab 1987 to 1997	216	
RAM			
1500	2014 to 2019	226	
RENAULT			
Alaskan	Thai-Built Only 2017+	228	
SSANGYONG			
Musso	Q200 10/2018+	231	
	Q201 10/2018+	231	
	Q205 10/2018+	231	
Rexton	Y400 2018+	236	
SUZUKI			
Jimny	GJ 2018+	242	
	2012 to 1/2019	244	
Grand Vitara	8/2005 to 2015	248	
TOYOTA			
4Runner	Gen 5, N280 2009+	252	
FJ Cruiser	2007+	258	
Fortuner	2015+	260	
	2004 to 2015	262	
Hilux	8/2020+	266	
	Revo 5/2018 to 7/2020	270	
	Revo 2015 to 4/2018	270	
	Vigo 2011 to 2015	274	
	Vigo 2005 to 2011	274	
	Tiger 1997 to 2004	278	
Landcruiser	200 Series (Facelift) 11/2015+	283	
	200 Series 2/2012 to 10/2015	286	
	200 Series 11/2007 to 1/2012	286	
	105 Series HZJ105, FZJ105 Live Axle Front Suspension 3/1998 to 10/2007	288	
	100 Series HDJ100, UZJ100 Independent Front Suspension 3/1998 to 10/2007	291	
	80 Series HZJ80, FZJ80 1990 to 1998	293	
	79 Series (V8 TD) Single Cab 9/2016+	296	
	79 Series (V8 TD) Single Cab 2007 to 8/2016	299	
	79 Series Single Cab 1999 to 2007	299	
	79 Series Dual Cab 11/2012+	299	
	78 Series Troop Carrier 2007+	303	
	78 Series 1999 to 2007	307	
	76 Series 2007+	311	
	75 Series 1984 to 1999	314	
	60 Series 11/1980 to 11/1989	320	
Prado	150 Series (Facelift) 11/2017+	328	
	150 Series 11/2013 to 10/2017	331	
	150 Series 11/2009 to 10/2013	331	
	120 Series 4/2003 to 10/2009	334	
	95 Series 1996 to 10/2002	336	
	90 Series 1996 to 10/2002	336	
Tacoma	2005+	338	
Tundra	2013 to 2020	340	
VOLKSWAGEN			
Amarok	V6 11/2016+	346	
	2011 to 10/2016	348	
ACCESSORIES SPARE PARTS			
Bull Bars	352	
Winches	353	
Tow Bars	354	
Driving Lights	354	
Canopies	354	
Canopy / Roof Racks	356	
Instant Awnings	356	
Rooftop Tents	357	
Swags	357	
Fridges	357	
Snorkels	358	
Underbody Protection	358	
Miscellaneous	358	
ACCESSORY INSTALLATION FITTING TIMES			
Approximate Accessory Fitting Times	359	
ACCESSORIES PRODUCT INFORMATION			
Features and Benefits	420	
ACCESSORIES TECHNICAL SPECIFICATIONS			
Monster Winches	426	
Bull Bars	426	
Rear Tow Bars	428	
Side Steps / Rails	428	
Rated Recovery Points	428	
Snorkels	430	
Underbody Protection	431	
Roof Racks and Accessories	432	
Canopies	433	
Driving Lights	434	
LED Worklights	435	
LED Light Bars	435	
Fridge / Freezers	436	
Fridge / Freezer Troubleshooting	436	
Locksafe Drawer Systems	437	
Rooftop Tent	438	
Swags	438	
QUICK REFERENCE INDEX			
Product Code Reference	439	
TERMS AND CONDITIONS			
Terms and Conditions of Trade	458	

Contents - Suspension to Suit

SUSPENSION TO SUIT (BY VEHICLE)

DACIA	
Duster	2010+ 40
FIAT	
Fullback	2016+ 42
FORD	
Courier	Ranger (not USA model) 1985 to 2006 60
Everest	UAll 7/2018+ 62
	3.2L 2015 TO 6/2018 64
Maverick	1988 to 1994 (See Nissan Patrol Page 217) 217
Ranger	Raptor 9/2018+ 45
	PX Mk III (not USA model) 7/2018+ 48
	PX Mk II (not USA model) 2015 to 6/2018 52
	T6 PX (not USA model) 2011 to 2015 56
	PJ / PK (not USA model) 3/2006 to 2011 59
HAVAL	
H9	Wagon 2.0L Petrol 8/2017+ 65
HOLDEN / GM	
Colorado	RG 2016 to 2020 75
	RG 2012 to 2016 78
	RG Low Ride 2WD 2012+ 80
	RC 2003 to 2012 82
Colorado 7	Trailblazer 2012+ 73
Frontera	1995 to 1/1999 69
Jackaroo	Bighorn / Monterey 1992+ 66
	11/1986 to 1991 67
	Pre 1996 68
Rodeo	RA 2003 to 2012 84
	RA7 2003 to 2012 84
	KB - TFS 1988 to 3/2003 86
	KB - TF 1983 to 1988 87
Trailblazer	LT / LTZ 2017+ 71
HYUNDAI	
Terracan	2001+ 89
ISUZU	
D-Max	8/2019+ 91
	2016 to 7/2019 94
	6/2012 to 1/2017 97
	Low Ride 2WD 2012+ 99
	2003 to 2012 101
MU-X	2013+ 103
Trooper	1992+ 104
	11/1986 to 1991 105
	Pre 1986 106
JEEP	
Cherokee	Liberty KK 2007 to 2012 107
	Liberty KJ 2001 to 2006 108
	XJ 1984+ 109
Gladiator	JT 2019+ 111
Grand Cherokee	WK2 (4x4) 2011+ 113
	WJ / WG 1999 to 6/2005 114
	ZJ / ZG 1993 to 1998 115
Wrangler	JL 2018+ 117
	JK 2006+ 119
	TJ 1996 to 2/2007 120
JMC	
Vigus	2014+ 121
KIA	
Sorento	BL 2003 to 2008 122
LADA	
Niva	1978+ 123
LAND ROVER	
Defender	110 Series County / Dual Cab 126
	130 Series County / Dual Cab 126
	110 Series Trayback 127
	90 Series 128
Discovery	Series 3 LR3 (Coil Springs) 2004 to 2009 131
	Series 2 (Coil Springs) 1999 to 2005 132
	Series 1 1989 to 2005 133
Range Rover	(Coil Springs) 1971 to 1995 129
LDV	
T60	2.8L Turbo Diesel 2017+ 134
MAHINDRA	
Scorpio	Getaway Pik-Up 2002 to 2016 136
	Wagon 2002 to 2014 137
MAZDA	
BT50	6/2020+ 140
	2011 to 5/2020 144
	2006 to 2011 147
B Series Bravo	1987 to 2006 149
MERCEDES BENZ	
G-Wagen	W460, W461 W463 1979+ 150
	G55 AMG 151
Unimog	UL1700, 2450, U5000, 1300, 1550, U4000 152
X-Class	4 Cyl Models 2017 to 5/2020 153
MITSUBISHI	
Challenger Montero Sport	PA (Coil) 1998 to 2008 167
	PA (Leaf) 1998 to 2006 168
Delica	L400 1994+ 169
Pajero	Montero NM - NX 2000+ 160
	iO Pinin 1999+ 161
	Montero NH - NL (Coil) 6/1991 to 2000 162
	Montero NH - NL (Leaf) 1991 to 1999 163
	Montero NA - NG (Coil) 1988 to 1991 164
	Montero NA - NG (Leaf) Pre 1991 165
Pajero Sport	7/2019+ 155
	2.4L Mivec 2015 to 6/2019 157
Pajero Sport / Montero Sport / Dakar	PB 2009 to 2015 166
Triton	MR 11/2018+ 172
	MQ L200 2015 to 10/2018 176
	MN L200 2009 to 2015 180
	ML L200 2006 to 2009 183
	MK L200 1996 to 2006 185
	ME-MJ 1993 to 1996 186
	L200 Pre 1983 187



Contents - Suspension to Suit

NISSAN

Navara	NP300 (Coil Springs) 2015+	189
	NP300 (Leaf Springs) 2014+	190
	D40 (V6 Diesel) 2005+	192
	D40 (4cyl Diesel and V6 Petrol) 2005+.....	193
	D22 / NP300 (Torsion Bar) 1997+.....	195
	D21 1985 to 1996	196
Paladin	Pre 2005	197
Pathfinder	R51 (V6 Diesel) 7/2005+	199
	R51 (4cyl Diesel and V6 Petrol) 7/2005+.....	201
	R50 1995 to 7/2005	202
	R20 Pre 1995	203
Patrol	Y62 2010+	205
	Y61 GU LWB Wagon.....	208
	Y60 GQ Cab Chassis (Coil / Coil)	212
	Y61 GU Cab Chassis (Coil / Coil).....	212
	Y60 GQ Cab Chassis (Coil / Leaf)	215
	Y61 GU Cab Chassis (Coil / Leaf).....	215
	Y60 GQ Cab Chassis (Leaf / Leaf) 1988+	217
	Y60 GQ LWB Wagon 1988 to 1998.....	218
	Y60 GQ SWB Wagon 1988 to 1998	220
	MK G160 (Rectangle Headlights) 1984+	222
	MQ G160 (Round Headlights) Pre 1984.....	223
Terrano/II WD21	Pre 1995	203
Xterra	2005+.....	224
Xtrail	T30 2001 to 9/2007	225

RAM

1500	DS 2014 to 2019	227
------	-----------------------	-----

RENAULT

Alaskan	2017+	229
Duster	2010+.....	230

SSANGYONG

Korando	1996 to 2006	235
Musso	Q200 SWB 10/2018+	232
	Q201 LWB (Coil) 10/2018+	233
	Q201 LWB (Leaf) 10/2018+	234
	Q205 LWB (Leaf) 10/2018+	234
	1996 to 2006	235
Rexton	Y400 2018+	237

SUBARU

Forester	2019+	238
	SF5, GX, RX, GT 1997 to 2013	239
Outback	2015+.....	240
XV	2018+.....	241

SUZUKI

Grand Vitara	8/2005 to 2015	249
	1988 to 7/2005	250
Jimny	GJ 2018+	243
	SN413 1998 to 2018	245
Sierra	SJ80 (Coil) 1997+	246
	Samurai LJ, SJ (Leaf) 1981+	247
Vitara	1988+.....	251

TOYOTA

4Runner	Gen 4 and 5, N210 - N280 2003+	253
	Gen 3 N180 - N185 1996 to 2002	254
	Gen 2 Surf N130 V6 (Coil) 1990 to 1997	255
	Gen 1 N60 (Leaf) 1988 to 1997	256
Bundera	1984 to 1989	317
FJ Cruiser	2006+.....	259
Fortuner	2015+.....	261
	2004 to 2015	263
Hiace	Series 300 2019+	264
	Series 200 2005 to 2019.....	265
Highlander	2020+.....	282
Hilux	8/2020+.....	268
	Revo 2015 to 7/2020.....	272
	Vigo 3/2005 to 9/2015	275
	Low Ride 2WD 2005+	277
	Tiger 107, 108, 110, 111 167 1997 to 2005	279
	Solid Front Axle 11/1983 to 11/1997	280
	Solid Front Axle 1979 to 10/1983	281
Kluger	2020+.....	282
Landcruiser	200 Series (Facelift) 11/2015+	284
	200 Series 11/2007 to 10/2015+	287
	105 Series 1998+	289
	100 Series, IFS 1998+.....	292
	80 Series 1990+	294
	79 Series Single Cab 1999+.....	297
	79 Series Dual Cab 2013+	300
	78 Series 2007+	304
	78 Series 1999 to 2007.....	308
	76 Series 2007+	312
	75 Series 1984 to 1999.....	315
	71 Series (Coil / Leaf) 1999+.....	318
	70, 73, 74 Series (Leaf / Leaf) 1984 to 1988.....	319
	60 Series 1986+	320
	60 Series Pre 1986.....	322
	45, 47 Series 8/1980 to 1985.....	324
	45 Series 1960 to 1980.....	325
	40, 42, 46 Series 1980 to 1984	326
	40 Series 1960 to 1980.....	327
Prado	150 Series (Coil) 12/2017+	329
	150 Series (Coil) 2009 to 11/2017	332
	120 Series 4/2003 to 10/2009	334
	90, 95 Series 1996 to 10/2002.....	337
	II Prado 70, 73, 78 Series 1990 to 1996.....	316
Rav4	2019 to 2021	257
Tacoma	2005+.....	339
Tundra	2013 to 2020	340
	2006 to 2013	341

TROLLER

T4	7/2014+.....	342
	1997 to 6/2014	343

UAZ

Hunter	All Models	344
Patriot	1997+.....	345

VOLKSWAGEN

Amarok	V6 / 4 Cyl 11/2016+.....	347
	1997 to 10/2016	349

Contents - Suspension to Suit

ACCESSORY INSTALLATION FITTING TIMES

Approximate Accessory Fitting Times	359
---	-----

GVM UPGRADES TO SUIT (BY VEHICLE)

Ranger	PX Mk III (not USA model) 7/2018+.....	364
	PX Mk II (not USA model) 2015 to 6/2018	365
	T6 PX (not USA model) 2011 to 2015	365
Colorado	RG 2016 to 2020	366
	RG 2012 to 2016	366
D-Max	8/2019+.....	367
	2016 to 7/2019	368
BT50	6/2020+.....	369
Jimny	GJ 2018+	370
Hilux	8/2020+.....	371
	Revo 2015 to 4/2018.....	371
	Vigo 3/2005 to 2015.....	372
Landcruiser	200 Series MC NA 2007+.....	373
	79 Series Single Cab 2012+	374
	79 Series Dual Cab 2012+	375
	78 Series Troop Carrier 2012+	376

SUSPENSION PART SELECTION

Understanding Load	378
Determining Load	379
Understanding Terrain	380
Understanding Valving	381
Understanding GVM Upgrades.....	382
Suspension Kit Selection.....	383
Shock Absorber Application Guide.....	384
Features and Benefits	388
Load Plus Helper Springs Application Guide	393

SUSPENSION TECHNICAL SPECIFICATIONS

Installation Times.....	396
Installation Form	397
Coil Springs Technical Specifications	398
Leaf Springs Technical Specifications.....	401
Torsion and Sway Bars Technical Specifications.....	403
Shock Absorbers - Nitro Gas Technical Specifications	404
Shock Absorbers - Foam Cell Technical Specifications	406
Shock Absorbers - Foam Cell Pro Technical Specifications	407
Steering Dampers Technical Specifications	410
Shock Absorber Mount Types Technical Specifications	411
Trim Packers Technical Specifications.....	412
U-Bolts Technical Specifications.....	413
Load Plus Helper Springs Technical Specifications	413
Suspension Rubber Arm Bush Kits Technical Specifications	414
Strut Compressor.....	415
FAQ / Troubleshooting	416

QUICK REFERENCE INDEX

Product Code Reference	439
------------------------------	-----

TERMS AND CONDITIONS

Terms and Conditions of Trade	458
-------------------------------------	-----



4WD and Touring Gear

CATALOGUE AND PRICE LIST
Effective 1 May 2021



Recovery

PRODUCT DESCRIPTION

PART NO.

QTY
Required

RETAIL
ea Incl GST

ELECTRIC WINCHES

Monster Winch 9500lb - 12V	WWB9500	\$859.00
Monster Winch 9500lb - 12V (With synthetic rope)	WWB9500SR	\$1079.00
Monster Winch 12000lb - 12V	WWB12000	\$967.00
Monster Winch 12000lb - 12V (With synthetic rope)	WWB12000SR	\$1187.00

WINCH ACCESSORIES

Winch Damper Blanket	WINCH BLANKET	\$38.00
Synthetic Winch Rope - 9.5mm x 27m (8100kg)	WWWROPE001	\$476.00
Alloy Hawse Fairlead	WWWHAWSE	\$82.00

RECOVERY KITS

Large Recovery Kit	IRECKIT003	\$358.00
Small Recovery Kit	IRECKIT004	\$175.00

**TECHNICAL DIMENSIONS AND SPECIFICATIONS
SEE PAGE 426**



WINCH WITH STEEL CABLE



WINCH WITH SYNTHETIC ROPE



SYNTHETIC ROPE



WINCH DAMPER BLANKET



ALLOY HAWSE



SMALL RECOVERY KIT



LARGE RECOVERY KIT



Recovery

PRODUCT DESCRIPTION

PART NO.

QTY
Required

RETAIL
ea Incl GST

RECOVERY STRAPS AND ACCESSORIES

Snatch Strap - 8000kg (9m x 75mm)	ISNATCH005	\$87.00
Snatch Strap - 11000kg (9m x 100mm)	ISNATCH006	\$116.00
Recovery Rope - 9500kg (9m x 22mm)	ISNATCHROPE	\$182.00
Winch Extension Strap - 4500kg (20m x 50mm)	IWINCHEXT	\$76.00
Tree Trunk Protector - 12000kg (3m x 75mm)	ITREE	\$53.00
Soft Shackle - 14000kg (500mm x 12mm)	ISOFSHA001	\$50.00
Soft Shackle- 17500kg (500mm x 12mm)	ISOFSHA002	\$61.00
Heavy Duty Drag Chain (5m x 8mm)	IDRAG	\$98.00
Snatch Block - 8000kg Rating	IBLOCK	\$65.00
Recovery Hitch - 4.75t Rating (With bow shackle)	IHOOK BOW	\$65.00
Bow Shackle - 4.75t Rating	IBOW	\$17.00
Universal Recovery Hook - 4500kg Rating	ITOW	\$25.00
Leather Recovery Gloves	IGLOVES	\$14.00
Large Recovery / Accessory Bag	IRECKIT001 BAG	\$33.00
Small Recovery / Accessory Bag	IRECKIT002 BAG	\$20.00



RECOVERY HOOK



RECOVERY HITCH



BOW SHACKLE



SNATCH BLOCK



**8000KG
SNATCH STRAP**



DRAG CHAIN

LEATHER GLOVES



**11000KG
SNATCH STRAP**



**TREE TRUNK
PROTECTOR**



**WINCH
EXTENSION STRAP**

**9500KG
RECOVERY ROPE**



SOFT SHACKLES



Recovery

PRODUCT DESCRIPTION

PART NO.

QTY
Required

RETAIL
ea Incl GST

COMPRESSORS

Air Champ Compressor - 12V (90L/min)

ICOMPRESSOR003

\$165.00

Air Champ Pro Compressor - 12V (160L/min)

ICOMPRESSOR004

\$220.00

TYRE ACCESSORIES

Speedy Deflator with Gauge

ISPEEDY

\$83.00

Air Champ Smart Deflator with Gauge

ITYRE005

\$66.00

Air Champ Compact Deflator

ITYRE004

\$39.00

Tyre Gauge - *While Stocks Last*

ITYRE003

\$29.00

Air Champ Pressure Gauge

ITYRE006

\$39.00

Air Champ Dual Inflator

ITYRE007

\$94.00

Air Champ Extension Hose to suit Dual Inflator (not shown)

ITYRE008

\$33.00

Tyre Repair Kit

ITYRE001

\$79.00

Tyre Repair Cord (Refill 25pc)

ITYRE002

\$19.00

DIFF BREATHER KIT

Diff Breather Kit

IDIFFBRE

\$114.00

AIR CHAMP 90L



AIR CHAMP PRO 160L



SMART DEFLATOR WITH GAUGE



SPEEDY DEFLATOR



COMPACT DEFLATOR

PRESSURE GAUGE



DUAL INFLATOR



TYRE GAUGE



LIMITED Stock



TYRE REPAIR KIT



DIFF BREATHER KIT



Recovery

PRODUCT DESCRIPTION

PART NO.

QTY
Required

RETAIL
ea Incl GST

LIFTING JACKS

4WD Lift Jack - 48" (Includes cover)

HIGHLIFT001

\$178.00

4WD Lift Jack - 60" (Includes cover)

HIGHLIFT002

\$202.00

Bumper Lift Kit

HIGHLIFT003

\$35.00

Tyre Lift Kit

HIGHLIFT004

\$79.00

TOTAL TRACTION (BY TREDS)

Recovery Tracks

ITREDS1100

\$273.00

MULTI-PURPOSE REAR WHEEL BAG

Rear Wheel Bag

IRWB001

\$90.00

SEAT COVERS

Universal Slip-On Seat Cover

ISEAT COVER

\$29.00

AIRBAG COMPATIBLE CANVAS SEAT COVERS

Vehicle Specific Fitted Seat Cover - Front

See Vehicle Listing

\$400.00

Vehicle Specific Fitted Seat Cover - Rear

See Vehicle Listing

\$400.00

HI VIS SAND FLAG

1m, 2m or 3m Length

IHVFLAG

\$150.00

ANCHOR TRACKS

305mm Anchor Track

ITRACK305

\$35.00

610mm Anchor Track

ITRACK610

\$52.00

Additional Rings - Twin Pack (2 Rings)

ITRACKRING

\$6.00

ANCHOR TRACK AND RINGS



IRON CLAD
LIMITED
LIFETIME
WARRANTY

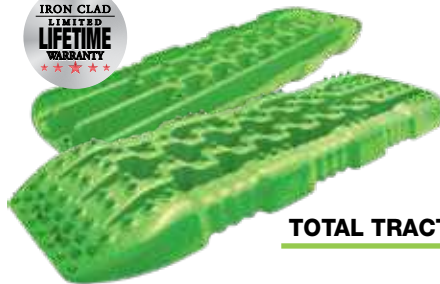

TOTAL TRACTION

MULTI-PURPOSE REAR WHEEL CARRIER BAG



4WD LIFT JACK 48" AND 60"



1 2 OR 3M HI VIS FLAG



TYRE LIFT KIT

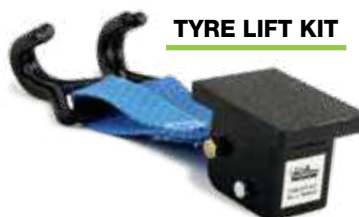

BUMPER LIFT KIT



UNIVERSAL SEAT COVER



CANVAS SEAT COVER





post isolation...



go local, support local

for a full range of accessories visit our website

www.ironman4x4.com



Camping Accessories

PRODUCT DESCRIPTION

PART NO.

QTY
Required

RETAIL
ea Incl GST

CAMP CHAIRS / SLEEPING

Deluxe Hard Arm Camp Chair (150kg rated)

ICHAIRHA004

\$86.00

Deluxe Soft Arm Camp Chair (150kg rated)

ICHAIRSA005

\$73.00

Deluxe Lounge Camp Chair (150kg rated)

ICHAIRL003

\$97.00

Mid Size Low Back Camp Chair (130kg rated)

ICHAIRMS

\$49.00

-5° Swag Bag Sleeping Bag

ISWAGBAG

\$168.00

SWAGS

Single Swag

ISWAG001

\$405.00

Double Swag

ISWAG002

\$459.00

**DELUXE HARD
ARM CHAIR**



**DELUXE SOFT
ARM CHAIR**



**DELUXE
LOUNGE CHAIR**



SWAG BAG SLEEPING BAG



**MID SIZE LOW
BACK CHAIR**



SINGLE SWAG



DOUBLE SWAG



Camping Accessories

PRODUCT DESCRIPTION

PART NO.

QTY
Required

RETAIL
ea Incl GST

CAMPING GEAR

- Quick-Fold Camping Steps (180kg rated)
- 50L Cargo Bag
- 65L Explorer Duffle Bag
- Foldable Bush Toilet (200kg rated)
- Bush Toilet Replacement Biodegradable Bags (10 per pack)
- 12L Ezy-Go Flushing Toilet
- Ezy-Go Flush Aid Part A & B (Sold together as 2 part kit)
- Eco Pressure Shower (Includes carry bag) - *While Stocks Last*

IQFSTEP	\$60.00
ICARGOBAG001	\$39.00
IDUFBAG001	\$83.00
IBUSHTOILET	\$114.00
IBTBAGS	\$14.00
ITOILET12	\$161.00
ITOILETA+B	\$24.00
ISHOWER002	\$95.00



65L DUFFLE BAG



QUICK-FOLD CAMPING STEPS



FOLDABLE BUSH TOILET



50L CARGO BAG



12 LITRE FLUSHABLE TOILET



EZY-GO FLUSH AID PART A+B



BUSH TOILET REPLACEMENT BAGS



ECO PRESSURE SHOWER

LIMITED Stock



Camping Accessories

PRODUCT DESCRIPTION

PART NO.

QTY
Required

RETAIL
ea Incl GST

FIRST AID

65 Piece Small Fold Out First Aid Kit (Includes snake bite kit)

IFAK002

\$99.00

135 Piece Large Fold Out First Aid Kit (Includes snake bite kit)

IFAK001

\$189.00

CAMPING TOOLS

2.0Kg (4.4lb) Axe Splitter

IAXE001

\$75.00

0.7Kg (1.5lb) Axe

IAXE002

\$23.00

Tent Peg Mallet

IMALLET

\$20.00

3 Piece Shovel (Incl. Carry Bag)

ISHOVEL001

\$162.00

CLEANING

500ml Gritty Hand Wash (Box of 6 only)

IHCLEANBOX

\$71.00

500ml Gritty Hand Wash (RRP only)

IHCLEAN

\$13.00

SMALL FOLD OUT FIRST AID KIT



LARGE FOLD OUT FIRST AID KIT



3 PIECE SHOVEL

2.0KG AXE / SPLITTER

0.7KG AXE

TENT PEG MALLET

GRITTY HAND WASH



Camp Lighting

PRODUCT DESCRIPTION

PART NO.

QTY
Required

RETAIL
ea Incl GST

LIGHTING

- LED Lantern
- Mini LED Lantern
- LED Lantern / Torch
- LED Worklight Combo
- LED Tent Light / Fan
- LED Tent Light
- LED Sensor Headlamp
- LED Light Strip (Includes switch)
- Awning 12V LED Sail Track Light Strip and Dimmer Set
- LED Dimmer
- LED Area Light

ILANTERN003	\$37.00
ILANTERN002	\$44.00
ILANTERN001	\$42.00
ILEDWLC	\$71.00
ITENTFAN002	\$39.00
ITENTLIGHT002	\$16.00
IHEADLAMP002	\$37.00
ILEDSTRIP	\$54.00
IAWNINGPART006	\$56.00
ILEDDIMMER	\$19.00
IAREALED001	\$119.00



LED LANTERN



MINI LED LANTERN



LED LANTERN / TORCH



LED TENT LIGHT / FAN



AWNING LED LIGHT STRIP / DIMMER SET



LED WORKLIGHT COMBO



LED DIMMER

LED LIGHT STRIP



Camp Lighting / Power

PRODUCT DESCRIPTION

PART NO.

QTY
Required

RETAIL
ea Incl GST

CAMPING POWER

120W Solar Panel Kit

200W Solar Panel Kit

ISOLAR120

\$649.00

ISOLAR200

\$849.00

NEW



120W / 200W SOLAR PANEL KIT

NEW



LED AREA LIGHT KIT

LED TENT LIGHT



LED SENSOR HEADLAMP



Camping

PRODUCT DESCRIPTION

PART NO.

QTY
Required

RETAIL
ea Incl GST

ROOFTOP TENT AND ACCESSORIES

Rooftop Tent (Only)

IROOFTENT TENT

\$1441.00

Rooftop Tent - Annex (Only)

IROOFTENT ANNEX

\$346.00

Rooftop Tent Extension Kit - Ladder (500mm)*

IROOFTENT002

\$67.00

Rooftop Tent Extension Kit - Annex (Room 200mm)*

IROOFTENT003

\$74.00

Rooftop Tent Hanging Bag

ITENTBAG001

\$38.00

* Required for tent bases sitting above 1.8m from ground.

ROOFTOP TENT DIMENSIONS - SEE PAGE 438

LUXURY ROOFTOP TENT



ROOFTOP TENT HANGING BAG



ANNEX WITH EXTENSION KIT



AWNING QUICK RELEASE BRACKET

Camping

PRODUCT DESCRIPTION

PART NO.

QTY
Required

RETAIL
ea Incl GST

INSTANT AWNINGS AND ACCESSORIES

Instant Awning 1.4m (L) x 2.0m (Out) (Inc. Brackets and LED Strip)	IAWNING1.4M	\$253.00
Instant Awning 2m (L) x 2.5m (Out) (Inc. Brackets and LED Strip)	IAWNING2M	\$279.00
Instant Awning 2.5m (L) x 2.5m (Out) (Inc. Brackets and LED Strip)	IAWNING2.5M	\$304.00
Awning Xtra Weathershield (Suits 2m Wide Awning) - 2m A x 2.4m B x 1.4m C	IAWNING2MWALL	\$155.00
Awning Xtra Weathershield (Suits 2.5m Wide Awning) - 2m A x 2.4m B x 1.4m C	IAWNING2.5MWALL	\$181.00
Awning Quick Release Bracket Kit - Opp. page	IAWNINGQR	\$140.00
Awning Quick Release Extra Hooks Kit - Opp. page	IAWNINGQR HOOK	\$67.00

AWNING ROOMS, ENCLOSURES AND ACCESSORIES

Awning Room with Fly Screen Netting (Suits 2m Awning IAWNING2M)	IAWNING2MROOM	\$294.00
Awning Room with Fly Screen Netting (Suits 2.5m Awning IAWNING2.5M)	IAWNING2.5MROOM	\$325.00
Instant Ensuite 1m x 1m	IENSUITE	\$308.00
Awning Pole Kit (2 x Poles, Ropes and Pegs to suit Awning Rooms)	IAWNINGPART009	\$34.00

AWNING ROOM



ADJUSTABLE POLE KIT



AWNING XTRA



LED INSTANT AWNING



INSTANT ENSUITE

Fridges / Freezers

PRODUCT DESCRIPTION

PART NO.

QTY
Required

RETAIL
ea Incl GST

ICECUBE FRIDGE / FREEZERS

30L Fridge / Freezer	IFRIDGE30	\$765.00
40L Fridge / Freezer	IFRIDGE40	\$840.00
50L Fridge / Freezer	IFRIDGE50	\$925.00
65L Fridge / Freezer - Fridge / Fridge - Freezer / Freezer	IFRIDGE65	\$1365.00
74L Fridge / Freezer	IFRIDGE74	\$1260.00

FRIDGE / FREEZER SLIDES

Fridge Slide - 30L, 40L, 50L (Inc. 4 x straps)	IFRIDGESLIDE001	\$270.00
Fridge Slide - 65L, 74L (Inc. 4 x straps)	IFRIDGESLIDE002	\$373.00

FRIDGE / FREEZER ACCESSORIES (BAGS SOLD SEPARATELY)

30L Fridge Bag	IFRIDGE30 BAG	\$103.00
40L Fridge Bag	IFRIDGE40 BAG	\$103.00
50L Fridge Bag	IFRIDGE50 BAG	\$108.00
65L / 74L Fridge Bag	IFRIDGE 65 74 BAG	\$135.00
Fridge Straps	IFRIDGE STRAPS	\$31.00
Wireless LCD Fridge Thermometer	IWFT001	\$31.00
Fridge Stand	IFRIDGESTAND001	\$55.00



TECHNICAL DIMENSIONS, SPECIFICATIONS AND FRIDGE TROUBLESHOOTING - SEE PAGE 436



LED Driving Lights

PRODUCT DESCRIPTION

PART NO.

QTY
Required

RETAIL
ea Incl GST

LED DRIVING LIGHTS

120W Megatom 2 in 1 Tri-Mode Operation LED - Driving Light (Each)	IMEGATOM	\$495.00
30W Comet 7" LED - Driving Light (Each) - <i>While Stocks Last</i>	ILED7C	\$193.00
42W Comet 9" LED - Driving Light (Each) - <i>While Stocks Last</i>	ILED9C	\$218.00
48W Meteor 7" LED with Daytime Running Light - Driving Light (Each)	ILED7M	\$267.00
102W Meteor 9" LED with Daytime Running Light - Driving Light (Each)	ILED9M	\$363.00
48W Blast Phase II 7" Combo LED - Driving Light (Each)	ILEDBLAST2C	\$242.00
48W Blast Phase II 7" Spot LED - Driving Light (Each)	ILEDBLAST2S	\$242.00
99W 5x7 Eclipse LED with Side Shooters - Driving Light (Each)	ILED5X7	\$242.00

BULL BAR LIGHT UPGRADES

10W Hi Lux LED to suit Ironman 4x4 Bull Bar Light Pods- Replaces Halogen Light (Pair)	BBPART031	\$109.00
Bull Bar LED Parker / Indicator / Daytime Running Light (Pair)	BBPART002	\$165.00

**TECHNICAL DIMENSIONS AND SPECIFICATIONS
SEE PAGE 434**

DRIVING LIGHTS



MEGATOM 2 IN 1

5X7 ECLIPSE

9" METEOR

7" METEOR

7" BLAST COMBO

7" BLAST SPOT

BULL BAR UPGRADE LIGHTS



9" COMET

7" COMET

**BULL BAR
FOG LIGHT**

**BULL BAR LED PARKER/
INDICATOR / DRL LIGHT**



LED Lightbars

PRODUCT DESCRIPTION

DATE AVAILABLE

PART NO.

QTY
Required

RETAIL
ea Incl GST

LED LIGHTBARS

30W Bright Sabre-X Single Row Slim Lightbar 177mm (7") Straight	Q2 2021	ILBSR005B	\$79.00
105W Bright Sabre-X Single Row Slim Lightbar 522mm (20") Straight	Q2 2021	ILBSR003B	\$210.00
165W Bright Sabre-X Single Row Slim Lightbar 798mm (32") Straight	Q2 2021	ILBSR002B	\$295.00
210W Bright Sabre-X Single Row Slim Lightbar 1005mm (40") Straight	Q2 2021	ILBSR001B	\$385.00
270W Bright Sabre-X Single Row Slim Lightbar 1281mm (50") Straight	Q2 2021	ILBSR000B	\$419.00
75W Bright Sabre Single Row Lightbar 524mm (20") Straight	Q2 2021	ILBSR003BW	\$189.00
120W Bright Sabre Single Row Lightbar 812mm (32") Straight	Q2 2021	ILBSR002BW	\$249.00
150W Bright Sabre Single Row Lightbar 1004mm (40") Straight	Q2 2021	ILBSR001BW	\$339.00
200W Bright Sabre Dual Row Lightbar 561mm (21.5") Straight	Q2 2021	ILBDR003B	\$349.00
300W Bright Sabre Dual Row Lightbar 815mm (32") Straight	Q2 2021	ILBDR002B	\$399.00
400W Bright Sabre Dual Row Lightbar 1076mm (42.5") Straight	Q2 2021	ILBDR001B	\$449.00
300W Bright Sabre Multi-Function Dual Row Lightbar 815mm (32") Straight	Q2 2021	ILBDR002BM	\$449.00
400W Bright Sabre Multi-Function Dual Row Lightbar 1076mm (42.5") Straight	Q2 2021	ILBDR001BM	\$599.00

BRIGHT SABRE-X SINGLE ROW LED SLIM LIGHTBARS

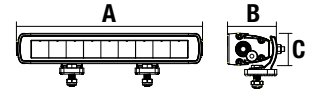

CODE	Beam	LEDs	Watts	A	B	C
ILBSR005B	Combo	6	30W	177mm	54mm	40mm
ILBSR003B	Combo	21	105W	522mm	54mm	40mm
ILBSR002B	Combo	33	165W	798mm	54mm	40mm
ILBSR001B	Combo	42	210W	1005mm	54mm	40mm
ILBSR000B	Combo	54	270W	1281mm	54mm	40mm

BRIGHT SABRE SINGLE ROW LED LIGHTBARS

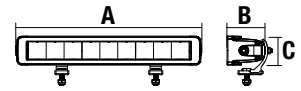

CODE	Beam	LEDs	Watts	A	B	C
ILBSR003BW	Combo	15	75W	524mm	66.5mm	52mm
ILBSR002BW	Combo	24	120W	812mm	66.5mm	52mm
ILBSR001BW	Combo	30	150W	1004mm	66.5mm	52mm

BRIGHT SABRE DUAL ROW LED LIGHTBARS

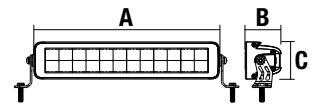

CODE	Beam	LEDs	Watts	A	B	C
ILBDR003B	Combo	40	200W	561mm	67mm	70mm
ILBDR002B	Combo	60	300W	815mm	67mm	70mm
ILBDR001B	Combo	80	400W	1076mm	67mm	70mm

BRIGHT SABRE DUAL ROW MULTI-FUNCTION LED LIGHTBARS

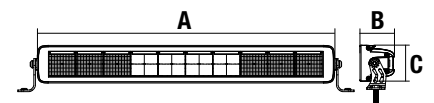

CODE	Beam	LEDs	Watts	A	B	C
ILBDR002BM	Combo	60	300W	815mm	70mm	67mm
<i>Interspersed Multi-Function LEDs - 45 White LEDs / 60 Amber LEDs</i>						
ILBDR001BM	Combo	80	400W	1076mm	70mm	67mm
<i>Interspersed Multi-Function LEDs - 60 White LEDs / 75 Amber LEDs</i>						



LED Lightbars / Driving Light Accessories

PRODUCT DESCRIPTION

PART NO.

QTY
Required

RETAIL
ea Incl GST

NIGHT SABRE SINGLE ROW LED LIGHTBARS

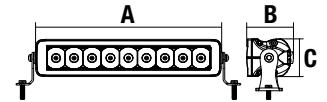

STRAIGHT BAR



CURVED BAR



CODE	Beam	LEDs	Watts	A	B	C
Straight Bar						
ILBSR004	Spot	9	45W	279mm	63mm	54mm
ILBSR003	Spot	18	90W	500mm	63mm	54mm
ILBSR002	Spot	27	135W	722mm	63mm	54mm
ILBSR001	Spot	36	180W	942mm	63mm	54mm

Curved Bar						
ILBSR003C	Spot	18	90W	500mm	63mm	54mm
ILBSR002C	Spot	27	135W	722mm	63mm	54mm
ILBSR001C	Spot	36	180W	942mm	63mm	54mm

MODULAR LIGHTBARS



**TECHNICAL DIMENSIONS AND SPECIFICATIONS
SEE PAGE 435**

LED LIGHTBARS

- 180W Night Sabre Lightbar 942mm (37") Straight
- 135W Night Sabre Lightbar 722mm (28.5") Straight
- 90W Night Sabre Lightbar 500mm (19.5") Straight
- 45W Night Sabre Lightbar 279mm (11") Straight
- 180W Night Sabre Lightbar 942mm (37") Curved
- 135W Night Sabre Lightbar 722mm (28.5") Curved
- 90W Night Sabre Lightbar 500mm (19.5") Curved
- 30W Modular Lightbar Flood Beam - 180mm L (3 x 10W LED, 2.5A) - *While Stocks Last*
- 30W Modular Lightbar Spot Beam - 180mm L (3 x 10W LED, 2.5A) - *While Stocks Last*

ILBSR001	\$424.00
ILBSR002	\$325.00
ILBSR003	\$231.00
ILBSR004	\$174.00
ILBSR001C	\$462.00
ILBSR002C	\$363.00
ILBSR003C	\$270.00
ILED180F	\$193.00
ILED180S	\$193.00

LED DRIVING LIGHT COVERS

- To Fit 7" Blast - Blue
- To Fit 7" Blast - Black
- To Fit 7" Blast - Amber
- To Fit 7" Blast - Clear
- To Fit 7" Comet - Blue
- To Fit 7" Comet - Black
- To Fit 7" Comet - Amber
- To Fit 7" Comet - Clear
- To Fit 9" Comet - Blue
- To Fit 9" Comet - Black
- To Fit 9" Comet - Amber
- To Fit 9" Comet - Clear

ILCB7BLUE	\$21.00
ILCB7BLACK	\$21.00
ILCB7AMBER	\$21.00
ILCB7CLEAR	\$21.00
ILC7BLUE	\$21.00
ILC7BLACK	\$21.00
ILC7AMBER	\$21.00
ILC7CLEAR	\$21.00
ILC9BLUE	\$27.00
ILC9BLACK	\$27.00
ILC9AMBER	\$27.00
ILC9CLEAR	\$27.00

DRIVING LIGHT COVERS



LED Work Lights

PRODUCT DESCRIPTION

DATE AVAILABLE

PART NO.

QTY
Required

RETAIL
ea Incl GST

LED WORK / BAR LIGHTS

30W Universal 3" with Side Shooters (Each)		ILEDUNI3	\$77.00
61W Universal 5" with Side Shooters (Each)		ILEDUNI5	\$160.00
18W Star Brite Rechargeable LED Floodlight (Each)		ILEDSB	\$161.00
20W Cosmo Dual LED Light (Each)		ILEDCOSMO	\$160.00
10W Spot Beam Universal LED Work Light - 93mm L (2 x 5W LED, 0.9A) - Clear		ILEDWL10	\$47.00
10W Flood Beam Universal LED Work Light - 93mm L (2 x 5W LED, 0.9A) - Amber		ILEDWL10FA	\$47.00
9W Flood Beam LED Rock Light - 77 x 44mm (Each) - Clear	Q2 2021	IRL120B	\$29.00
20W Bright Cube Spot Beam LED Cube Light - 70 x 64mm (Each) - Clear	Q2 2021	ILED20B	\$59.00
20W Bright Cube Spot Beam LED Cube Light - 70 x 64mm (Each) - Amber	Q2 2021	ILED20BA	\$59.00
20W Bright Cube Flood Beam LED Cube Light - 70 x 64mm (Each) - Clear	Q2 2021	ILED20BF	\$59.00
20W Bright Cube Flood Beam LED Cube Light - 70 x 64mm (Each) - Amber	Q2 2021	ILED20BFA	\$59.00
20W Bright Cube Flood Beam LED Cube Light - 70 x 64mm (Each) - Red	Q2 2021	ILED20BFR	\$59.00
40W Bright Cube Spot Beam LED Cube Light - 81 x 75mm (Each) - Clear	Q2 2021	ILED80B	\$79.00
40W Bright Cube Spot Beam LED Cube Light - 81 x 75mm (Each) - Amber	Q2 2021	ILED80BA	\$79.00
40W Bright Cube Flood Beam LED Cube Light - 81 x 75mm (Each) - Clear	Q2 2021	ILED80BF	\$79.00
40W Bright Cube Flood Beam LED Cube Light - 81 x 75mm (Each) - Amber	Q2 2021	ILED80BFA	\$79.00

**TECHNICAL DIMENSIONS AND SPECIFICATIONS
SEE PAGE 434**

LED WORK LIGHTS



3" UNIVERSAL



5" UNIVERSAL



**STARBRITE
RECHARGEABLE FLOODLIGHT**



COSMO DUAL LIGHT



**UNIVERSAL SPOT
WORK LIGHT**



**UNIVERSAL FLOOD
WORK LIGHT**



**9W ROCK
LIGHT**



20W CUBE LIGHT



40W CUBE LIGHT

Wire Looms / Auto Electrical / Dual Battery Systems

PRODUCT DESCRIPTION

PART NO.

QTY
Required

RETAIL
ea Incl GST

LIGHT WIRING LOOMS

Light Bar / Work Light Wiring Loom - Suits One (1) Light	IWHL001	\$37.00
Driving Light Wiring Loom - Suits Set of Two (2) Lights	IWHL002	\$55.00
Driving Light Wiring Loom - Suits Set of Two (2) Lights with Daytime Running Lights	IWHL003	\$61.00
Megatom Wiring Loom - Suits Set of Two (2) Megatom Lights	IWHL004	\$97.00

AUTO ELECTRICAL

40A DC to DC Battery Charger with Solar Input	IDCDCSOLAR	\$633.00
40A DC to DC Battery Charger (80A when combined with Start Assist Kit)	IDCDC40	\$565.00
Start Assist Booster Kit (Suits IDCDC40 Only)	IDDCSA	\$158.00
12V Digital Battery Monitor (Suits single and dual battery setups)	IDBM001	\$173.00
Dual Battery Monitor (Only) - <i>While Stocks Last</i>	DB MONITOR	\$168.00
140A Battery Manager (Only)	DB140	\$114.00
275A Battery Manager (Only)	DB270	\$286.00
Dual Battery Loom - <i>While Stocks Last</i>	DBLOOM	\$220.00
Electric Brake Controller (With remote head)	IEBC001	\$226.00
Auto Headlight On Kit (Lights on / keys on) - <i>While Stocks Last</i>	IALK001	\$216.00
Low Water Alarm (12V / 24V) - <i>While Stocks Last</i>	ILWA001	\$250.00
50A Charge Wire Kit (6m x 8mm2 High Current Cable)	IAPKIT	\$140.00
Universal Fit Battery Tray for Ute Tubs (not shown)	IBTRAYTUB	\$239.00

LIGHT WIRING LOOMS

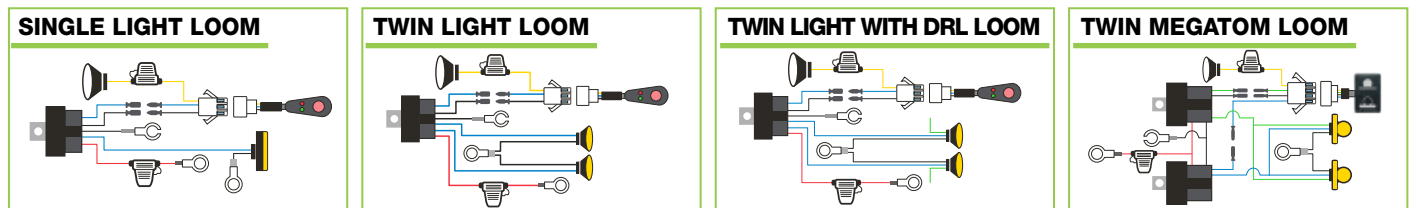

NEW



40A DC TO DC INTEGRATED SOLAR BATTERY CHARGER



40A DC TO DC BATTERY CHARGER



START ASSIST BOOSTER KIT

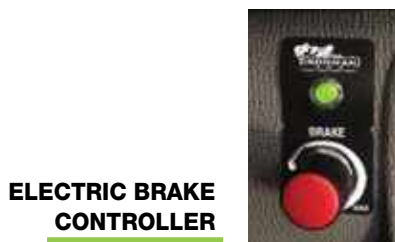

ELECTRIC BRAKE CONTROLLER



AUTO HEADLIGHT ON KIT



LOW WATER ALARM



50A CHARGE WIRE KIT



DIGITAL BATTERY MONITOR



DUAL BATTERY MONITOR



140A BATTERY MANAGER



275A BATTERY MANAGER

Storage - Locksafe Drawer Systems

PRODUCT DESCRIPTION	PART NO.	QTY Required	RETAIL ea Incl GST
LOCKSAFE SINGLE DRAWERS			
Single Drawer - 900mm	ISD900		\$767.00
Single Drawer - 1000mm	ISD1000		\$783.00
Single Drawer - 1300mm	ISD1300		\$891.00
LOCKSAFE TWIN DRAWERS			
Twin Drawers - 900mm	ITD900		\$1242.00
Twin Drawers - 1000mm	ITD1000		\$1296.00
Twin Drawers - 1300mm	ITD1300		\$1469.00
WING KITS*			
Left and Right Pair - 900mm	Vehicle Specific		\$270.00
Left and Right Pair - 1000mm	Vehicle Specific		\$270.00
Left and Right Pair - 1300mm	Vehicle Specific		\$351.00
FRIDGE / FREEZER SLIDES			
Fridge Slide - 30L, 40L, 50L (Inc. 4 x straps)	IFRIDGESLIDE001		\$270.00
Fridge Slide - 65L, 74L (Inc. 4 x straps)	IFRIDGESLIDE002		\$373.00
ANCHOR TRACKS			
305mm Anchor Track	ITRACK305		\$35.00
610mm Anchor Track	ITRACK610		\$52.00
Additional Rings - Twin Pack (2 Rings)	ITRACKRING		\$6.00

**TECHNICAL DIMENSIONS AND SPECIFICATIONS SEE PAGE 437
REFER TO VEHICLE LISTING PAGES FOR SPECIFIC MODEL COMPATIBILITY / SUITABILITY**

**ANCHOR TRACK
AND RINGS**



**TWIN DRAWER SYSTEM
AND WING KIT**



FRIDGE SLIDE



***Designed to suit factory tubs, will not suit tub liner without modification**



SINGLE DRAWER SYSTEM



Storage - Water Tanks

PRODUCT DESCRIPTION

PART NO.

QTY
Required

RETAIL
ea Incl GST

WATER TANKS - L X D X H

- 1. 20L Jerry Can with Tap - (350 x 170 x 460mm)
- 2. 40L Double Jerry Can with Barbed Outlet - (465 x 340 x 335mm)
- 3. 40L Vertical Tank with Barbed Outlet - (1100 x 75 x 700mm*)
- 4. 50L Roof Rack Tank with Barbed Outlet - (1200 x 600 x 120mm*)
- 5. 50L Wheel Arch Tank with Barbed Outlet - (1215 x 120 x 590mm*)
- 6. 50L Tapered Tank with Tap and Barbed Outlet - (1050 x 200 x 390mm*)
- 7. 60L Tank with Tap and Barbed Outlet - (845 x 360 x 270mm*)
- 8. 1.5m Plastic Water Hose Kit - Connects to barbed outlet on tanks
- 9. 15L Under Tray Hand Wash Tank with Tap - (345 x 255 x 305mm)

- IWT001
- IWT002
- IWT003
- IWT004
- IWT005
- IWT006
- IWT007
- IWTHOSE
- IWT008

- \$102.00
- \$197.00
- \$327.00
- \$327.00
- \$327.00
- \$257.00
- \$262.00
- \$54.00
- \$176.00

*Includes the height of the screw cap



WATER STORAGE TANKS



UNDER TRAY HAND WASH TANK



* Hand Wash not included

Storage - Plastic

PRODUCT DESCRIPTION

PART NO.

QTY
Required

RETAIL
ea Incl GST

MAXI CASES - L X D X H

- 48L - 410 x 410 x 410mm - *Does not include removable tool tray
- 60L - 550 x 460 x 335mm (Includes tool tray)
- 65L - 900 x 460 x 250mm - *Does not include removable tool tray (not shown)
- 100L - 700 x 460 x 410mm (Includes tool tray)
- 140L - 915 x 460 x 440mm (Includes tool tray)
- 216L - 1300 x 460 x 460mm (Includes tool tray)

IMC001	\$174.00
IMC002	\$218.00
IMC006	\$268.00
IMC003	\$273.00
IMC004	\$346.00
IMC005	\$444.00

UTE BOXES - L X D X H

- 140L - 1320 x 505 x 475mm - *While Stocks Last*
- 200L - 1400 x 540 x 540mm - *While Stocks Last*

UTEBOX001	\$654.00
UTEBOX002	\$684.00

60L MAXI CASE

100L MAXI CASE



**INCLUDES REMOVABLE
TOOL/STORAGE TRAY**



140L MAXI CASE

48L MAXI CASE*

216L MAXI CASE



200L UTE BOX EXTRA



140L UTE BOX



Storage - Metal

PRODUCT DESCRIPTION

PART NO.

QTY
Required

RETAIL
ea Incl GST

ALUMINIUM TOOL BOXES - L X D X H

- Aluminium One Tonner - 900 x 500 x 680mm - *While Stocks Last*
- Aluminium One Tonner - 1210 x 500 x 680mm - *While Stocks Last*
- Aluminium Low Profile - 950 x 600 x 500mm - *While Stocks Last*
- Aluminium Low Profile - 1250 x 600 x 500mm - *While Stocks Last*
- Aluminium Under-Tray Box - 750/520 x 270 x 440mm (LHS) - *While Stocks Last*
- Aluminium Gull Wing Truck Box - 1770 x 550 x 400mm - *While Stocks Last*

- | | |
|--------|----------|
| ITB001 | \$659.00 |
| ITB002 | \$785.00 |
| ITB003 | \$519.00 |
| ITB004 | \$659.00 |
| ITB007 | \$270.00 |
| ITB009 | \$713.00 |

STEEL TOOL BOXES - L X D X H

- Steel Truck Box - 700 x 640 x 750mm
- Steel Truck Box - 1210 x 640 x 750mm

- | | |
|--------|-----------|
| ITB005 | \$1037.00 |
| ITB006 | \$1485.00 |

ALUMINIUM ONE TONNER



STEEL TRUCK BOX



LIMITED Stock



ALUMINIUM GULL WING TRUCK BOX

LIMITED Stock



ALUMINIUM UNDER-TRAY LH BOX

LIMITED Stock



ALUMINIUM LOW PROFILE

Storage - Bags

PRODUCT DESCRIPTION

PART NO.

QTY
Required

RETAIL
ea Incl GST

CARRY AND UTILITY STORAGE BAGS - L X W X D

- 200L Weatherproof Rooftop Cargo Storage Bag - 1400 x 500 x 300mm
- 250L Weatherproof Rooftop Cargo Storage Bag - 1100 x 800 x 300mm
- 350L Weatherproof Rooftop Cargo Storage Bag - 1200 x 960 x 300mm
- 500L Weatherproof Rooftop Cargo Storage Bag - 1500 x 1100 x 300mm
- 600L Weatherproof Rooftop Cargo Storage Bag - 1800 x 1100 x 300mm
- 50L Cargo Bag
- 65L Explorer Duffle Bag
- Rooftop Tent Hanging Bag

IRLB200	\$192.00
IRLB250	\$216.00
IRLB350	\$250.00
IRLB500	\$296.00
IRLB600	\$334.00
ICARGOBAG001	\$39.00
IDUFBAG001	\$83.00
ITENTBAG001	\$38.00

200L ROOFTOP BAG



250L ROOFTOP BAG



350L ROOFTOP BAG



500L ROOFTOP BAG



600L ROOFTOP BAG



50L CARGO BAG



ROOFTOP TENT HANGING BAG



65L DUFFLE BAG



Alloy Roof Racks / Extrusion Rails

PRODUCT DESCRIPTION

PART NO.

QTY
Required

RETAIL
ea Incl GST

ALLOY ROOF RACKS - POWDERCOATED METALLIC GREY, MESH FLOOR

Cage Style - 1.4m x 1.25m	IRRCAGE14-ALLOY	\$897.00
Cage Style - 1.8m x 1.25m	IRRCAGE18-ALLOY	\$1049.00
Cage Style - 2.2m x 1.25m	IRRCAGE22-ALLOY	\$1106.00
Flat Rack - 1.8m x 1.25m	IRRTFLAT18-ALLOY	\$1019.00
Trade Style - 1.4m x 1.25m (Open end)	IRROPEN14-ALLOY	\$886.00
Trade Style - 1.8m x 1.25m (Open end)	IRRTRADE18-ALLOY	\$1033.00
Trade Style - 2.2m x 1.25m (Open end)	IRRTRADE22-ALLOY	\$1078.00
Crossbar	IRRCROSSBAR001	\$250.00

UNIVERSAL ALLOY ROOF RAIL EXTRUSION - SOLD SEPARATELY

Alloy Extrusion - 1085mm (2 Pieces - Inc. mounting hardware)	IRREXT1085	\$113.00
--	------------	----------

REFER TO VEHICLE LISTING PAGES FOR SPECIFIC MODEL COMPATIBILITY / SUITABILITY



FLAT RACK



TRADE STYLE



CAGE STYLE

EXTRUSIONS

GUTTER MOUNT FEET

CHANNEL MOUNT FEET



Steel Roof Racks / Mount Kits

PRODUCT DESCRIPTION

PART NO.

QTY
Required

RETAIL
ea Incl GST

STEEL ROOF RACKS - POWDERCOATED BLACK, MESH FLOOR

Cage Style - 1.4m x 1.25m	IRRAGE14	\$709.00
Cage Style - 1.8m x 1.25m	IRRAGE18	\$744.00
Cage Style - 2.2m x 1.25m	IRRAGE22	\$772.00
Rooftop Tent Compatible - 1.8m x 1.25m	IRRTENT18	\$709.00
Rooftop Tent Compatible - 2.2m x 1.25m	IRRTENT22	\$744.00
Trade Style - 1.8m x 1.25m (Open end)	IRRTRADE18	\$709.00
Trade Style - 2.2m x 1.25m (Open end)	IRRTRADE22	\$738.00

REFER TO VEHICLE LISTING PAGES FOR SPECIFIC MODEL COMPATIBILITY / SUITABILITY



CAGE STYLE



TRADE STYLE



ROOFTOP TENT

ROOF RACK MOUNTING KITS - SOLD SEPARATELY

Gutter Mount Feet - 100mm (8 Feet)	IRRFEET100	\$180.00
Gutter Mount Feet - 125mm (8 Feet)	IRRFEET125	\$180.00
Gutter Mount Feet - 150mm (8 Feet)	IRRFEET150	\$180.00
Gutter Mount Feet - 210mm (8 Feet)	IRRFEET210	\$199.00
Mount Feet to suit Holden Colorado 7/Trailblazer (6 Feet) - Fits fact fitted roof bars only	IRRFEET001	\$180.00
Mount Feet to suit Toyota Landcruiser 100/105 (8 Feet)	IRRFEETLC100	\$180.00
Mount Feet to suit Toyota Landcruiser 200 (8 Feet)	IRRFEETLC200	\$180.00
Mount Feet to suit Isuzu MU-X (6 Feet) - Fits factory fitted roof bars only	IRRFEETMUX	\$199.00
Mount Feet to suit Toyota Prado 150 (2 Feet)	IRRFEETPRADO150	\$199.00
ABS Canopy Feet to suit 1.4m Rack	IRRFEETABS14	\$250.00
Wheel Clamp	IRRWHEELCLAMP	\$91.00

**TECHNICAL DIMENSIONS AND SPECIFICATIONS SEE PAGE 364
REFER TO VEHICLE MANUFACTURER FOR SPECIFIC ROOF LOAD CARRYING CAPACITY**



Fleet and Mining Accessories

PRODUCT DESCRIPTION

PART NO.

QTY
Required

RETAIL
ea Incl GST

FLEET / MINING ACCESSORIES

- High Mount Flag - 1.8m (With red LED)
- High Mount Flag - 2.4m (With red LED)
- Hi Vis Sand Flag (1m, 2m or 3m length)
- High Visibility Light Bar (With lights, reverse alarm and beacon)
- Universal Battery Isolator / Jump Start
- Auto Headlight On Kit (Lights on / keys on)
- Low Water Alarm (12V / 24V)
- Premium Grade Universal Embossed Mud Flaps - *While Stocks Last*
- Reverse Camera - OE Approved (With rear view mirror replacement) - *While Stocks Last*
- Fire Extinguisher (1kg)
- 135 Piece Large Fold Out First Aid Kit
- Safety Triangles (set of 3)
- Wheel Chocks - Rated to 6 tonne (set of 2)

MINING001	\$146.00
MINING008	\$152.00
IHVFLAG	\$150.00
MINING005	\$449.00
IBATISO	\$326.70
IALK001	\$216.00
ILWA001	\$250.00
IFT-MUDFLAP	\$66.00
IREVERSECAM001	\$594.00
IFIRE EXTINGUISHER	\$46.00
IFAK001	\$189.00
ISAFETYTRI	\$95.00
IWC6T	\$118.00

HIGH VISIBILITY LIGHT BAR



**1, 2 OR 3M
HI VIS FLAG**



**HIGH MOUNT
FLAG**

**AUTO
HEADLIGHT ON KIT**



LIMITED Stock

LIMITED Stock

LOW WATER ALARM



LIMITED Stock

UNIVERSAL MUD FLAPS



FIRE EXTINGUISHER



LIMITED Stock

OE APPROVED REVERSE CAMERA



SAFETY TRIANGLES

BATTERY ISOLATOR/JUMP START



LIMITED Stock

FIRST AID KIT



WHEEL CHOCKS



Apparel

PRODUCT DESCRIPTION

PART NO.

QTY
Required

RETAIL
ea Incl GST

IRONMAN 4X4 60TH ANNIVERSARY T-SHIRT

Size Mens - S	IMTS001MS	\$33.00
Size Mens - M	IMTS001MM	\$33.00
Size Mens - L	IMTS001ML	\$33.00
Size Mens - XL	IMTS001MXL	\$33.00
Size Mens - 2XL	IMTS001M2XL	\$33.00
Size Mens - 3XL	IMTS001M3XL	\$33.00
Size Mens - 5XL	IMTS001M5XL	\$33.00
Size Womens - S	IMTS001WS	\$33.00
Size Womens - M	IMTS001WM	\$33.00
Size Womens - L	IMTS001WL	\$33.00
Size Womens - XL	IMTS001WXL	\$33.00

IRONMAN 4X4 FOAM CELL PRO T-SHIRT

Size Mens - S	IMTS002MS	\$37.00
Size Mens - M	IMTS002MM	\$37.00
Size Mens - L	IMTS002ML	\$37.00
Size Mens - XL	IMTS002MXL	\$37.00
Size Mens - 2XL	IMTS002M2XL	\$37.00
Size Mens - 3XL	IMTS002M3XL	\$37.00
Size Mens - 5XL	IMTS002M5XL	\$37.00

OILSKIN COOPER JACKET

Size - M	Limited Stock Available	IMCOOPBN05	\$316.00
Size - L	Limited Stock Available	IMCOOPBN06	\$316.00
Size - XL	Limited Stock Available	IMCOOPBN07	\$316.00
Size - XXL	Limited Stock Available	IMCOOPBN08	\$316.00
Size - XXXL	Limited Stock Available	IMCOOPBN09	\$316.00
Size - XXXXL	Limited Stock Available	IMCOOPBN10	\$316.00

OILSKIN CAPRICORN VEST

Size - L	Limited Stock Available	IMCAPRIBN06	\$191.00
Size - XL	Limited Stock Available	IMCAPRIBN07	\$191.00
Size - XXL	Limited Stock Available	IMCAPRIBN08	\$191.00
Size - XXXL	Limited Stock Available	IMCAPRIBN09	\$191.00
Size - XXXXL	Limited Stock Available	IMCAPRIBN10	\$191.00

FRONT OF BOTH SHIRTS



FOAM CELL PRO T-SHIRT



60TH ANNIVERSARY T-SHIRT



Merchandise

PRODUCT DESCRIPTION

PART NO.

QTY
Required

RETAIL
ea Incl GST

MERCHANDISE

Ironman 4x4 Key Rings
 Ironman 4x4 Bottle Opener Key Rings
 Ironman 4x4 Numberplate Surrounds - Standard Fit (Pair)
 Ironman 4x4 Numberplate Surrounds - Slimline Fit (Pair)
 Ironman 4x4 Car Air Freshener (Adventure Fresh) *Non-retail sold as box of 150 only
 Ironman 4x4 Stubby Holder
 Ironman 4x4 Metal Drink Bottle - Silver with Ironman 4x4 Logo
 Ironman 4x4 Metal Drink Bottle - Grey with Foam Cell Pro Logo
 The Australian 4WD Handbook
 Discover Oz Productions - Top Of Down Under DVD (Vol 2)
 Discover Oz Productions - Top Of Down Under DVD (Vol 3)
 Discover Oz Productions - Top Of Down Under DVD (Vol 4)
 Discover Oz Productions - Top Of Down Under DVD (Vol 5)
 Discover Oz Productions - Top Of Down Under DVD (Vol 6)
 Ironman 4x4 Adventure Challenge WA 2012
 Ironman 4x4 Adventure Challenge WA 2013
 Ironman 4x4 Adventure Challenge WA 2014
 Ironman 4x4 Adventure Challenge WA 2016
 Black Ironman 4x4 Cap

KEY001	\$2.00
KEY002	\$3.00
INUMBPLATE	\$9.00
INUMBPLATESLIM	\$9.00
IAIRFRESHBOX	\$1.10
CAN001	\$5.00
IBOTTLE001	\$15.00
IBOTTLE002	\$15.00
IBOOK001	\$48.00
DVD001	\$40.00
DVD004	\$40.00
DVD006	\$40.00
DVD007	\$40.00
DVD008	\$40.00
DVD002	\$33.00
DVD003	\$37.00
DVD005	\$37.00
DVD009	\$33.00
CAP001	\$13.00

IRONMAN 4X4 KEY RINGS



IRONMAN 4X4 NUMBERPLATE SURROUNDS



IRONMAN 4X4 CAP



IRONMAN 4X4 CAR AIR FRESHENER



IRONMAN 4X4 STUBBY HOLDER



IRONMAN 4X4 DRINK BOTTLE



DISCOVER OZ PRODUCTIONS TOP OF DOWN UNDER (DVD)



ADVENTURE CHALLENGE (DVD)



IRONMAN 4X4 THE AUSTRALIAN 4WD HANDBOOK





Unlock your adventure



- ACCESSORIES
- SUSPENSION
- GVM UPGRADES

for a full range of accessories visit our website

www.ironman4x4.com



Accessories and Suspension

CATALOGUE AND PRICE LIST

Effective 1 May 2021

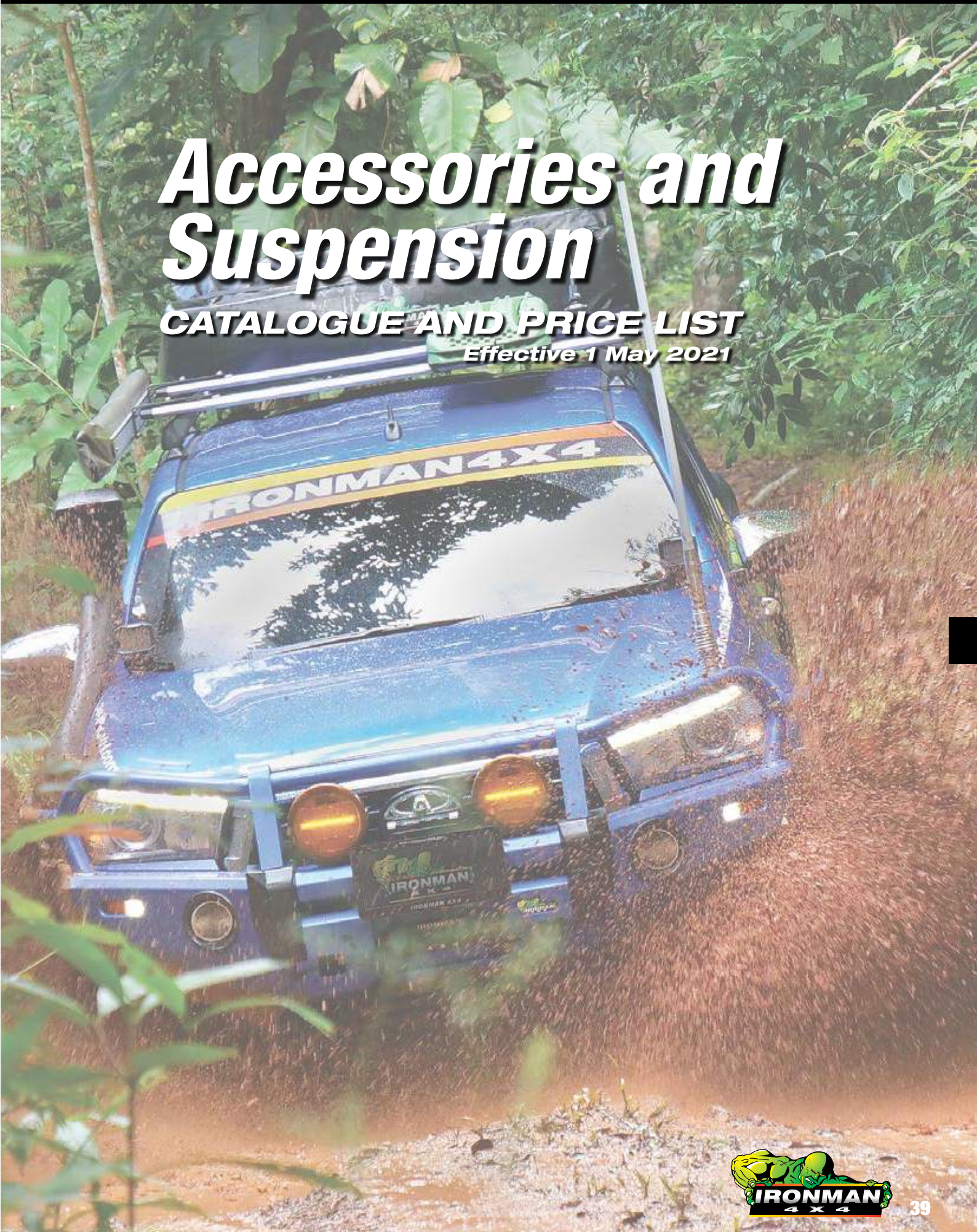

Dacia Duster

2010+



PRODUCT DESCRIPTION

PART NO.

QTY
Required

RETAIL
ea Incl GST

SUSPENSION TO SUIT DACIA DUSTER

FRONT SUSPENSION

SHOCK ABSORBER

Nitro Gas Strut - Performance			12747GR	2	\$261.36
-------------------------------	--	--	----------------	---	----------

COIL SPRINGS

Medium	Est. Lift 40mm	Additional Load 0 - 50kg	REN001B	1	\$235.23
--------	-------------------	-----------------------------	----------------	---	----------

CAMBER CORRECTION

Camber Bolt Kit			ICAMBER12	1	\$26.14
-----------------	--	--	------------------	---	---------

REAR SUSPENSION

SHOCK ABSORBER

Nitro Gas Strut - Performance			12748GR	2	\$261.36
-------------------------------	--	--	----------------	---	----------

COIL SPRINGS

Medium	Est. Lift 40mm	Additional Load 0 - 200kg	REN002B	1	\$235.23
--------	-------------------	------------------------------	----------------	---	----------

CAMBER CORRECTION

Camber Bolt Kit			ICAMBER12	1	\$26.14
-----------------	--	--	------------------	---	---------

SUSPENSION KIT

Medium - Nitro Gas			REN001BKG		\$1568.16
--------------------	--	--	------------------	--	-----------

SUSPENSION KIT CONTENTS

Shock Absorbers

Camber Bolt Kits

Coil Springs

Fiat Fullback

2016+

PRODUCT DESCRIPTION

PART NO.

QTY
RequiredRETAIL
ea Incl GST

ACCESSORIES TO SUIT FIAT FULLBACK

STEEL WINCH BULL BARS

Commercial	BBC050	\$1598.00
Commercial Deluxe	BBCD050	\$2021.00
Polished Alloy	BBA050	\$2517.00
Proguard No Loop	BBT050-NL	\$1670.00
Proguard Single Loop Kit	BB050-SL	\$297.00
Proguard Triple Loop Kit	BB050-TL	\$357.00

STEEL SIDE STEPS AND RAILS - FITS DUAL AND CLUB CAB

Side Steps	SS050	\$851.00
Side Rails	SS050 RAIL	\$280.00
Side Steps and Rails	SSR050	\$1022.00

TOWING

Class 4 Towbar - Compatible with Factory Rear Bumper	TB050	\$523.00
Rear Protection Towbar - Full Rear Bumper Replacement	RTB050	\$1196.00
Rear Protection Towbar Plates (Pair)	RTBPLATE050	\$131.00
Towbar Wiring Loom - Plug and Play	ITBL050	\$237.00

RECOVERY POINTS - IRONMAN 4X4 BULL BAR ONLY

Recovery Points - 5000kg Rating (Pair)	IRP050	\$265.00
--	--------	----------

LOCKSAFE DRAWER SYSTEMS - FITS DUAL AND EXTRA CAB

Twin Drawers - 1300mm	ITD1300	\$1469.00
Single Drawer - 1300mm	ISD1300	\$891.00
Wing Kit - 1300mm*	ITDW050	\$351.00

*Designed to suit factory tubs, will not suit ute liner without modification.

BATTERY TRAY

Suits 12" Battery	IBTRAY050	\$229.00
-------------------	-----------	----------

SNORKEL - SUITS 2.4L DIESEL

Triton MQ 2015+	ISNORKEL050	\$387.00
-----------------	-------------	----------

LONG RANGE FUEL TANK

125L* Diesel only - Fits Dual Cab only	TANK004	\$1129.00
--	---------	-----------

* Usable volume may differ to the stated tank capacity

PREMIUM UNDERBODY PROTECTION

Engine Bay and Transmission	UBP050	\$712.00
-----------------------------	--------	----------

UNDERBODY PROTECTION

Engine Bay and Transmission - Not compatible with bull bars.	IUP050K	\$562.00
--	---------	----------

EXHAUST SYSTEM

3" Exhaust Upgrade 2.4L 2015+ - DPF Back - While Stocks Last	IEX067	\$770.00
--	--------	----------

CANOPY - ABS PLASTIC (SIDE LIFT UP WINDOWS AND CENTRAL LOCKING REAR DOOR) - FITS 4X4 AND 4X2 DUAL CAB MODELS

Pre Primed	CANOPY014-P	\$3143.00*
Black Mica (X08)	CANOPY014-BM	\$3743.00
Impulse Blue (D23)	CANOPY014-IB	\$3743.00
Sterling Silver (U25)	CANOPY014-SS	\$3743.00
Earth Green (F27)	CANOPY014-EG	\$3743.00
Palma Red (R59)	CANOPY014-RS	\$3743.00
Titanium Grey (U17)	CANOPY014-TG	\$3743.00
White Solid (W32)	CANOPY014-WS	\$3743.00

* Pre-primed canopies, plus colour coding.

CANOPY - SMOOTH FINISH FIBREGLASS PINNACLE (SIDE LIFT UP WINDOWS AND CENTRAL LOCKING REAR DOOR) - FITS 4X4 AND 4X2 DUAL CAB MODELS

Pre-Primed	CANFIBRE050-P	\$2783.00*
Black Mica (X08)	CANFIBRE050-BM	\$3297.00
Impulse Blue (D23)	CANFIBRE050-IB	\$3297.00
Titanium Grey (U17)	CANFIBRE050-TG	\$3297.00
Sterling Silver (U25)	CANFIBRE050-SS	\$3297.00
White Solid (W32)	CANFIBRE050-WS	\$3297.00

* Pre-primed canopies, plus colour coding.

DIFF BREATHER KIT

Diff Breather Kit	IDIFFBRE	\$114.00
-------------------	----------	----------

Fiat Fullback

2016+



PRODUCT DESCRIPTION

PART NO.

QTY
Required

RETAIL
ea Incl GST

SUSPENSION TO SUIT FIAT FULLBACK

FRONT SUSPENSION

SHOCK ABSORBER

Nitro Gas Strut - Performance ¹			12715GR	2	\$209.09
Foam Cell Strut - Performance ¹			24715FE	2	\$235.23
Foam Cell Pro Strut - Performance* (SEE NOTE)			45715FE	2	\$365.91

*NOTE: MANDATORY FITMENT of UCA050FA and MITS045B /C Coil Springs with 45715FE

¹ Height adjustable with Ironman 4x4 Strut Trim Packers

COIL SPRINGS

	Est. Lift	Additional Load			
Standard	0mm	0 - 50kg	MITSO40S	1	\$235.23
Light	25mm	0 - 50kg	MITSO40A	1	\$235.23
Medium	30mm	0 - 80kg	MITSO40B	1	\$235.23
Medium* (SEE NOTE)	50mm	0 - 80kg	MITSO45B *	1	\$235.22
Heavy	30mm	80 - 110kg	MITSO40C	1	\$235.23
Heavy* (SEE NOTE)	50mm	80 - 110kg	MITSO45C *	1	\$235.23

*NOTE: MANDATORY FITMENT of UCA050FA and 45715FE with (MITSO45B /C) Coil Springs

STRUT MOUNTS

Steel Strut Top			ISST010	2	\$91.48
-----------------	--	--	----------------	---	---------

TRIM PACKERS

5mm Strut Trim Packer	Nitro Gas / Foam Cell	HILFR05 / HILFR05F	2	\$26.14
10mm Strut Trim Packer	Nitro Gas / Foam Cell	HILFR10 / HILFR10F	2	\$26.14
15mm Strut Trim Packer	Nitro Gas / Foam Cell	HILFR15 / HILFR15F	2	\$26.14

• ONLY Compatible with Ironman 4x4 Struts, lift height subject to 2:1 motion ratio. Unnecessary fitment may lift vehicle too high

CONTROL ARMS

Pro-Forge Upper Control Arms			UCA050FA	1	\$831.60
------------------------------	--	--	-----------------	---	----------



Fiat Fullback

2016+

PRODUCT DESCRIPTION

PART NO.

QTY
RequiredRETAIL
ea Incl GST

REAR SUSPENSION

SHOCK ABSORBER

Nitro Gas - Comfort			12729GRC	2	\$143.75
Nitro Gas - Performance			12729GR	2	\$143.75
Nitro Gas - Professional			12729GRP	2	\$143.75
Foam Cell - Comfort			24729FEC	2	\$209.09
Foam Cell - Performance			24729FE	2	\$209.09
Foam Cell - Professional			24729FEP	2	\$209.09
Foam Cell Pro - Comfort			45729FEC	2	\$287.50
Foam Cell Pro - Performance			45729FE	2	\$287.50
Foam Cell Pro - Professional			45729FEP	2	\$287.50

LEAF SPRINGS

	Est. Lift	Additional Load			
Light	30mm	0 - 200kg	MITSO47A	2	\$352.84
Medium	30mm	0 - 300kg	MITSO47B	2	\$352.84
Heavy	30mm	300kg - GVM	MITSO47C	2	\$378.98

• Two piece tailshaft models may experience driveline vibration, use 1201K to reduce vibration.

U-BOLTS

U-Bolt Kit			437UBK	2	\$39.21
U-Bolt Kit	Suits MITS047C		437UBKL	2	\$39.21

POLYURETHANE SPRING BUSHES

Bush Kit			1200UK	1	\$78.41
----------	--	--	---------------	---	---------

DRIVELINE SPACERS

Centre Bearing Spacer Kit			1201K	1	\$104.55
---------------------------	--	--	--------------	---	----------

SPACER KIT

Brake Hose Relocation Kit			1205K	1	\$52.28
---------------------------	--	--	--------------	---	---------

GREASABLE SHACKLES AND PINS

Greasable Shackle			1199	2	\$52.28
Non-Greasable Pin			387-1	2	\$26.14

HELPER SPRINGS

Load Plus Helper Springs			LP3	1	\$156.82
Add-A-Leaf			ISL6010	1	\$156.82

SUSPENSION KIT

Light - Nitro Gas			MITSO47AKG		\$1960.20
Light - Foam Cell			MITSO47AKF		\$2143.16
Medium - Nitro Gas			MITSO47BKG		\$1960.20
Medium - Foam Cell			MITSO47BKF		\$2143.16
Medium - Foam Cell Pro			MITSO47BKP		\$3476.09
Heavy - Nitro Gas			MITSO47CKG		\$2012.48
Heavy - Foam Cell			MITSO47CKF		\$2195.43
Heavy - Foam Cell Pro			MITSO47CKP		\$3528.36

• Specify Front Coil Springs when ordering

• Two piece tailshaft models may experience driveline vibration, use 1201K to reduce vibration

SUSPENSION KIT CONTENTS

Shock Absorbers	Coil Springs	Upper Control Arms (Foam Cell Pro Kits Only)	Brake Hose Relocation Kit
Leaf Springs	U-Bolts	Polyurethane Spring Bushes	Centre Bearing Spacer Kit
Strut Shock Absorbers			



Complete vehicle solutions!

for a full range of accessories visit our website

www.ironman4x4.com





9/2018+

Ford Ranger Raptor

PRODUCT DESCRIPTION	PART NO.	QTY Required	RETAIL ea Incl GST
ACCESSORIES TO SUIT FORD RANGER RAPTOR			
TOWING			
Rear Protection Towbar - Full Rear Bumper Replacement (60.3mm bar)	RTB069		\$1288.00
LOCKSAFE DRAWER SYSTEMS - FITS DUAL AND EXTRA CAB			
Twin Drawers - 1300mm	ITD1300		\$1469.00
Single Drawer - 1300mm	ISD1300		\$891.00
Wing Kit - 1300mm*	ITDW037		\$351.00
<i>*Designed to suit factory tubs, will not suit ute liner without modification.</i>			
BATTERY TRAY - DUAL CAB ONLY			
Suits 12" Battery	IBTRAY054		\$191.00
EXHAUST SYSTEM			
3" Exhaust Upgrade 2.0L - DPF Back - <i>While Stocks Last</i>	IEX069		\$770.00
CANOPY - ABS PLASTIC (SIDE LIFT UP WINDOWS AND CENTRAL LOCKING REAR DOOR) - FITS 4X4 AND 4X2 DUAL CAB MODELS			
Pre-Primed	CANOPY010-P †		\$3743.00*
Cool White (WVA) (A2W)	CANOPY010-CW		\$3743.00
Aurora Blue (WVD) (39A)	CANOPY010-AB		\$3743.00
Highlight Silver (18G)	CANOPY010-S		\$3743.00
Winning Blue (WVW)	CANOPY010-WB		\$3743.00
Magnetic Grey (WVQ)	CANOPY010-M †		\$3743.00
True Red (SWH)	CANOPY010-TR		\$3743.00
Meteor Grey (42A) (SWT)	CANOPY010-G †		\$3743.00
Frozen White (WVZ)	CANOPY010-FW †		\$3743.00
Metropolitan Grey (WVT) (36C)	CANOPY010-MG		\$3743.00
Aluminium Metallic (SWR) (38P)	CANOPY010-AM		\$3743.00
Ingot Silver (WVR)	CANOPY010-IS †		\$3743.00
Shadow Black (UO)	CANOPY010-SB †		\$3743.00
Blue Lightning (SW3)	CANOPY010-BL †		\$3743.00
Arctic White (SWU)	CANOPY010-AW †		\$3743.00
ABS Canopy Rack Feet	IRRFETABS14		\$250.00
<ul style="list-style-type: none"> • Includes tub strengthening bracket (CANOPY010 BRACKET) • Colour code and build date must be confirmed for Aluminium Metallic Canopies (CANOPY010-AM) • See Page 33 and 34 for 1.4m Roof Rack options and pricing. 			
<i>* Pre-primed canopies, plus colour coding. † Includes central locking.</i>			
CANOPY - SMOOTH FINISH FIBREGLASS PINNACLE (SIDE LIFT UP WINDOWS AND CENTRAL LOCKING REAR DOOR) - FITS 4X4 AND 4X2 DUAL CAB MODELS			
Pre-Primed	CANFIBRE054-P		\$2783.00*
Frozen White (WVZ)	CANFIBRE054-FW		\$3297.00
Magnetic Grey (WVQ)	CANFIBRE054-M		\$3297.00
Winning Blue (WVW)	CANFIBRE054-WB		\$3297.00
Blue Lightning (SW3)	CANFIBRE054-BL		\$3297.00
Ingot Silver (WVR)	CANFIBRE054-IS		\$3297.00
Shadow Black (UO)	CANFIBRE054-SB		\$3297.00
Arctic White (SWU)	CANFIBRE054-AW		\$3297.00
<ul style="list-style-type: none"> • Includes tub strengthening bracket (CANOPY010 BRACKET) 			
<i>* Pre-primed canopies, plus colour coding.</i>			
TUB STRENGTHENING BRACKET			
To suit all Canopies - (Must be fitted)	CANOPY010 BRACKET		\$49.00
SEAT COVER			
Canvas Comfort - Front	ICSC069F		\$400.00
Canvas Comfort - Rear	ICSC055R		\$400.00
DIFF BREATHER KIT			
Diff Breather Kit	IDIFFBRE		\$114.00

Ford Ranger

PX Mk III 8/2018+
WITH or WITHOUT Tech Pack
Adaptive Cruise Control



PRODUCT DESCRIPTION

PART NO.

QTY
Required

RETAIL
ea Incl GST

ACCESSORIES TO SUIT FORD RANGER

STEEL WINCH BULL BARS

Commercial - With parking sensor provisions Without Tech Pack	BBC055	\$1598.00
Commercial Deluxe - With parking sensor provisions Without Tech Pack	BBCD055	\$2021.00
Commercial Deluxe - With or Without Tech Pack	BBCD066	\$2021.00
Proguard No Loop - With or Without Tech Pack	BBT066-NL	\$1670.00
Proguard Single Loop Kit	BB066-SL	\$297.00
Proguard Triple Loop Kit	BB066-TL	\$357.00
Driving Light Patch Loom	IPL066	\$34.00

- Winch with Steel Cable and Roller Fairlead is not suitable for use with BBCD066 and BBT066 - Use Winch with Synthetic Rope and Alloy Hawse only
- Can also be fitted to both 2WD and 4WD models.

STEEL SIDE STEPS AND RAILS - FITS DUAL CAB MODELS ONLY

Side Steps	SS054	\$851.00
Side Rails	SS054 RAIL	\$280.00
Side Steps and Rails	SSR054	\$1022.00

TOWING

Class 4 Towbar - Compatible with Factory Rear Bumper (Not Wild Track)	TB038	\$523.00
Rear Protection Towbar - Full Rear Bumper Replacement	RTB038	\$1196.00
Rear Protection Towbar Plates (Pair)	RTBPLATE001	\$131.00
Towbar Wiring Loom - Plug and Play	ITBL054	\$303.00

RECOVERY POINTS - IRONMAN 4X4 BULL BAR ONLY

Recovery Points - 5000kg Rating (Pair)	IRP054	\$300.00
--	--------	----------

LOCKSAFE DRAWER SYSTEMS - FITS DUAL AND EXTRA CAB

Twin Drawers - 1300mm	ITD1300	\$1469.00
Single Drawer - 1300mm	ISD1300	\$891.00
Wing Kit - 1300mm*	ITDW037	\$351.00

*Designed to suit factory tubs, will not suit ute liner without modification.

SNORKEL - 3.2L MODELS ONLY

XL - (with side indicator)*	ISNORKELO34	\$387.00
XLT - (with indicator on side mirror)*	ISNORKELO34XLT	\$387.00

*Does not suit 2.0L 8/2018 PX III model.

BATTERY TRAY - DUAL CAB ONLY

Suits 12" Battery	IBTRAY054	\$191.00
-------------------	-----------	----------

LONG RANGE FUEL TANK

140L* - Suitable for 2.2L and 3.2L Diesel Dual Cab, Extra Cab and Single Cab	TANK007	\$1129.00
--	---------	-----------

* Usable volume may differ to the stated tank capacity

PREMIUM UNDERBODY PROTECTION

Engine Bay and Transmission - DPF Models (Retains factory transmission plate)	UBP055	\$500.00
---	--------	----------

EXHAUST SYSTEM

3" Exhaust Upgrade 3.2L - DPF Back - While Stocks Last	IEX054	\$770.00
--	--------	----------



Ford Ranger

PX Mk III 8/2018+
WITH or WITHOUT Tech Pack
Adaptive Cruise Control

PRODUCT DESCRIPTION

PART NO.

QTY
RequiredRETAIL
ea Incl GST**CANOPY - ABS PLASTIC (SIDE LIFT UP WINDOWS AND CENTRAL LOCKING REAR DOOR) - FITS 4X4 AND 4X2 DUAL CAB MODELS**

Pre-Primed	CANOPY010-P †	\$3143.00*
Cool White (WVA) (A2W)	CANOPY010-CW	\$3743.00
Aurora Blue (WVD) (39A)	CANOPY010-AB	\$3743.00
Highlight Silver (18G)	CANOPY010-S	\$3743.00
Winning Blue (WVW)	CANOPY010-WB	\$3743.00
Magnetic Grey (WVQ)	CANOPY010-M †	\$3743.00
True Red (SWH)	CANOPY010-TR	\$3743.00
Meteor Grey (42A) (SWT)	CANOPY010-G †	\$3743.00
Frozen White (WVZ)	CANOPY010-FW †	\$3743.00
Metropolitan Grey (WVT) (36C)	CANOPY010-MG	\$3743.00
Aluminium Metallic (SWR)	CANOPY010-AM	\$3743.00
Ingot Silver (WVR)	CANOPY010-IS †	\$3743.00
Shadow Black (UO)	CANOPY010-SB †	\$3743.00
Blue Lightning (SW3)	CANOPY010-BL †	\$3743.00
Arctic White (SWU)	CANOPY010-AW †	\$3743.00
ABS Canopy Rack Feet	IRRFEETABS14	\$250.00

• Includes tub strengthening bracket (CANOPY010 BRACKET)

• Colour code and build date must be confirmed for Aluminium Metallic Canopies (CANOPY010-AM)

• See Page 33 and 34 for 1.4m Roof Rack options and pricing.

* Pre-primed canopies, plus colour coding. († With central locking)

CANOPY - SMOOTH FINISH FIBREGLASS PINNACLE (SIDE LIFT UP WINDOWS AND CENTRAL LOCKING REAR DOOR) - FITS 4X4 AND 4X2 DUAL CAB MODELS

Pre-Primed	CANFIBRE054-P	\$2783.00*
Frozen White (WVZ)	CANFIBRE054-FW	\$3297.00
Magnetic Grey (WVQ)	CANFIBRE054-M	\$3297.00
Winning Blue (WVW)	CANFIBRE054-WB	\$3297.00
Blue Lightning (SW3)	CANFIBRE054-BL	\$3297.00
Ingot Silver (WVR)	CANFIBRE054-IS	\$3297.00
Shadow Black (UO)	CANFIBRE054-SB	\$3297.00
Arctic White (SWU)	CANFIBRE054-AW	\$3297.00

• Includes tub strengthening bracket (CANOPY010 BRACKET)

* Pre-primed canopies, plus colour coding.

TUB STRENGTHENING BRACKET

To suit all Canopies - (Must be fitted)	CANOPY010 BRACKET	\$49.00
---	-------------------	---------

SEAT COVER

Canvas Comfort - Front	ICSC054F	\$400.00
Canvas Comfort - Rear	ICSC055R	\$400.00

DIFF BREATHER KIT

Diff Breather Kit	IDIFFBRE	\$114.00
-------------------	----------	----------

LISTING
CONTINUED
OVER THE
PAGE



PRODUCT DESCRIPTION

PART NO.

QTY
RequiredRETAIL
ea Incl GST

SUSPENSION TO SUIT FORD RANGER

FRONT SUSPENSION

SHOCK ABSORBER

Nitro Gas Strut - Performance			12827GR	2	\$209.09
Foam Cell Strut - Performance			24827FE	2	\$235.23
Foam Cell Pro Strut - Performance			45827FE	2	\$365.91

• Height adjustable with Ironman 4x4 Strut Trim Packers

COIL SPRINGS

	Est. Lift	Additional Load			
Standard	0mm	0 - 50kg	FOR005S	1	\$235.23
Light	35mm	0 - 50kg	FOR005A	1	\$235.23
Medium	40mm	0 - 50kg	FOR005B	1	\$235.23
Heavy	45mm	50 - 110kg	FOR005C	1	\$235.23

STRUT MOUNTS

Steel Strut Top			ISST055	2	\$91.48
Bump Stop Base Holder			PBC055	2	\$21.78

TRIM PACKERS

5mm Strut Trim Packer	Foam Cell		HILFR05F	2	\$26.14
10mm Strut Trim Packer	Foam Cell		HILFR10F	2	\$26.14
15mm Strut Trim Packer	Foam Cell		HILFR15F	2	\$26.14

• ONLY Compatible with Ironman 4x4 Struts (except Pro), lift height subject to 2:1 motion ratio. Unnecessary fitment may lift vehicle too high

SWAY BAR LINK

Adjustable Sway Bar Link			1214K	2	\$72.60
--------------------------	--	--	--------------	---	---------

CONTROL ARMS

Pro-Forge Upper Control Arms			UCA054FA	1	\$831.60
------------------------------	--	--	-----------------	---	----------

REAR SUSPENSION

SHOCK ABSORBER

Nitro Gas - Comfort			12095GRC	2	\$143.75
Nitro Gas - Performance			12095GR	2	\$143.75
Foam Cell - Comfort			24095FEC	2	\$209.09
Foam Cell - Performance			24095FE	2	\$209.09
Foam Cell - Professional			24095FEP	2	\$209.09
Foam Cell Pro - Comfort			45095FEC	2	\$287.50
Foam Cell Pro - Performance			45095FE	2	\$287.50
Foam Cell Pro - Professional			45095FEP	2	\$287.50

LEAF SPRINGS

	Est. Lift	Additional Load			
Light	40mm	0 - 200kg	FOR002A	2	\$352.84
Medium	45mm	0 - 300kg	FOR002B	2	\$352.84
Heavy	45mm	300kg - GVM	FOR002C	2	\$378.98

• Possible driveline vibration may occur due to increased ride height, use 1194K to reduce vibration to satisfactory level

U-BOLTS

U-Bolt Kit			417UBK	2	\$39.21
------------	--	--	---------------	---	---------

POLYURETHANE SPRING BUSHES

Bush Kit			1193UK	1	\$156.82
----------	--	--	---------------	---	----------

DRIVELINE SPACERS

Centre Bearing Spacer Kit			1194K	1	\$39.21
---------------------------	--	--	--------------	---	---------

GREASABLE SHACKLES AND PINS

Greasable Shackle			1147	2	\$52.28
Non-Greasable Pin			387-1	2	\$26.14

HELPER SPRINGS

Load Plus Helper Springs			LP3	1	\$156.82
Add-A-Leaf			ISL6010	1	\$156.82





PX Mk III
Not USA Model
7/2018+

SUSPENSION TO SUIT

Ford Ranger

PRODUCT DESCRIPTION

PART NO.

QTY
Required

RETAIL
ea Incl GST

SUSPENSION KIT

Light - Nitro Gas	FOR005AKG	\$1921.00
Light - Foam Cell	FOR005AKF	\$2103.95
Light - Foam Cell Pro	FOR005AKP	\$2522.13
Medium - Nitro Gas	FOR005BKG	\$1921.00
Medium - Foam Cell	FOR005BKF	\$2103.95
Medium - Foam Cell Pro	FOR005BKP	\$2522.13
Heavy - Nitro Gas	FOR005CKG	\$1973.27
Heavy - Foam Cell	FOR005CKF	\$2156.22
Heavy - Foam Cell Pro	FOR005CKP	\$2574.40

• Specify front Coil Springs when ordering

• Possible driveline vibration may occur due to increased ride height, use 1194K to reduce vibration to satisfactory level

SUSPENSION KIT CONTENTS

Shock Absorbers	Coil Springs	U-Bolts	Centre Bearing Spacer Kit
Strut Shock Absorbers	Leaf Springs	Polyurethane Spring Bushes	



OPTIONS AVAILABLE FOR THIS VEHICLE - SEE PAGE 364



Ford Ranger

PRODUCT DESCRIPTION

PART NO.

QTY
Required

RETAIL
ea Incl GST

ACCESSORIES TO SUIT FORD RANGER

STEEL WINCH BULL BARS

Commercial - With parking sensor provisions Without Tech Pack	BBC055	\$1598.00
Commercial Deluxe - With parking sensor provisions Without Tech Pack	BBCD055	\$2021.00
Commercial Deluxe - With or Without Tech Pack	BBCD054	\$2021.00
Proguard No Loop - With or Without Tech Pack	BBT054-NL	\$1670.00
Proguard Single Loop Kit	BB054-SL	\$297.00
Proguard Triple Loop Kit	BB054-TL	\$357.00
Driving Light Patch Loom	IPL066	\$34.00

• Can also be fitted to both 2WD and 4WD models.

STEEL SIDE STEPS AND RAILS - FITS DUAL AND SINGLE CAB MODELS ONLY

Side Steps	SS054	\$851.00
Side Rails	SS054 RAIL	\$280.00
Side Steps and Rails	SSR054	\$1022.00

TOWING

Class 4 Towbar - Compatible with Factory Rear Bumper (Not Wild Track)	TB038	\$523.00
Rear Protection Towbar - Full Rear Bumper Replacement	RTB038	\$1196.00
Rear Protection Towbar Plates (Pair)	RTBPLATE001	\$131.00
Towbar Wiring Loom - Plug and Play	ITBL054	\$303.00

RECOVERY POINTS - IRONMAN 4X4 BULL BAR ONLY

Recovery Points - 5000kg Rating (Pair)	IRP054	\$300.00
--	--------	----------

LOCKSAFE DRAWER SYSTEMS - FITS DUAL AND EXTRA CAB

Twin Drawers - 1300mm	ITD1300	\$1469.00
Single Drawer - 1300mm	ISD1300	\$891.00
Wing Kit - 1300mm*	ITDW037	\$351.00

*Designed to suit factory tubs, will not suit ute liner without modification.

SNORKEL

XL - (with side indicator)	ISNORKELO34	\$387.00
XLT - (with indicator on side mirror)	ISNORKELO34XLT	\$387.00

BATTERY TRAY- DUAL CAB ONLY

Suits 12" Battery	IBTRAY054	\$191.00
-------------------	-----------	----------

EXHAUST SYSTEM

3" Exhaust Upgrade 3.2L - DPF Back - While Stocks Last	IEX054	\$770.00
--	--------	----------

LONG RANGE FUEL TANK

140L* - Suitable for 2.2L and 3.2L Diesel Dual Cab, Extra Cab and Single Cab	TANK007	\$1129.00
--	---------	-----------

* Usable volume may differ to the stated tank capacity

PREMIUM UNDERBODY PROTECTION

Engine Bay and Transmission - Non DPF Models	UBP054	\$712.00
Engine Bay and Transmission - DPF Models (Retains factory transmission plate)	UBP055	\$500.00

UNDERBODY PROTECTION

Engine Bay and Transmission	IUP014K	\$494.00
Fuel Tank	IUP014F	\$296.00

• Fuel tank protection plates are not compatible with long range fuel tanks.



Ford Ranger



PX Mk II 2015 to 7/2018
WITH or WITHOUT Tech Pack
Adaptive Cruise Control

PRODUCT DESCRIPTION	PART NO.	QTY Required	RETAIL ea Incl GST
CANOPY - ABS PLASTIC (SIDE LIFT UP WINDOWS AND CENTRAL LOCKING REAR DOOR) - FITS 4X4 AND 4X2 DUAL CAB MODELS			
Pre-Primed	CANOPY010-P †		\$3143.00*
Cool White (WVA) (A2W)	CANOPY010-CW		\$3743.00
Aurora Blue (WVD) (39A)	CANOPY010-AB		\$3743.00
Highlight Silver (18G)	CANOPY010-S		\$3743.00
Winning Blue (WVW)	CANOPY010-WB		\$3743.00
Magnetic Grey (WVQ)	CANOPY010-M †		\$3743.00
True Red (SWH)	CANOPY010-TR		\$3743.00
Meteor Grey (42A) (SWT)	CANOPY010-G †		\$3743.00
Frozen White (WVZ)	CANOPY010-FW †		\$3743.00
Metropolitan Grey (WVT) (36C)	CANOPY010-MG		\$3743.00
Ingot Silver (WVR)	CANOPY010-IS †		\$3743.00
Shadow Black (UO)	CANOPY010-SB †		\$3743.00
Blue Lightning (SW3)	CANOPY010-BL †		\$3743.00
Arctic White (SWU)	CANOPY010-AW †		\$3743.00
ABS Canopy Rack Feet	IRRFETABS14		\$250.00
<ul style="list-style-type: none"> • Includes tub strengthening bracket (CANOPY010 BRACKET) • Colour code and build date must be confirmed for Aluminium Metallic Canopies (CANOPY010-AM) • See Page 33 and 34 for 1.4m Roof Rack options and pricing. 			
* Pre-primed canopies, plus colour coding. († With central locking)			
CANOPY - SMOOTH FINISH FIBREGLASS PINNACLE (SIDE LIFT UP WINDOWS AND CENTRAL LOCKING REAR DOOR) - FITS 4X4 AND 4X2 DUAL CAB MODELS			
Pre-Primed	CANFIBRE054-P		\$2783.00*
Frozen White (WVZ)	CANFIBRE054-FW		\$3297.00
Magnetic Grey (WVQ)	CANFIBRE054-M		\$3297.00
Winning Blue (WVW)	CANFIBRE054-WB		\$3297.00
Blue Lightning (SW3)	CANFIBRE054-BL		\$3297.00
Ingot Silver (WVR)	CANFIBRE054-IS		\$3297.00
Shadow Black (UO)	CANFIBRE054-SB		\$3297.00
Arctic White (SWU)	CANFIBRE054-AW		\$3297.00
<ul style="list-style-type: none"> • Includes tub strengthening bracket (CANOPY010 BRACKET) 			
* Pre-primed canopies, plus colour coding.			
TUB STRENGTHENING BRACKET			
To suit all Canopies - (Must be fitted)	CANOPY010 BRACKET		\$49.00
SEAT COVER			
Canvas Comfort - Front	ICSC054F		\$400.00
Canvas Comfort - Rear	ICSC055R		\$400.00
DIFF BREATHER KIT			
Diff Breather Kit	IDIFFBRE		\$114.00

LISTING
CONTINUED
OVER THE
PAGE





PRODUCT DESCRIPTION

PART NO.

QTY
RequiredRETAIL
ea Incl GST

SUSPENSION TO SUIT FORD RANGER

FRONT SUSPENSION

SHOCK ABSORBER

Nitro Gas Strut - Performance			12727GR	2	\$209.09
Foam Cell Strut - Performance			24727FE	2	\$235.23
Foam Cell Pro Strut - Performance			45727FE	2	\$365.91

• Height adjustable with Ironman 4x4 Strut Trim Packers

COIL SPRINGS

	Est. Lift	Additional Load			
Standard	0mm	0 - 50kg	FOR001S	1	\$235.23
Light	35mm	0 - 50kg	FOR001A	1	\$235.23
Medium	40mm	0 - 50kg	FOR001B	1	\$235.23
Heavy	45mm	50 - 110kg	FOR001C	1	\$235.23

STRUT MOUNTS

Steel Strut Top			ISST014	2	\$78.41
-----------------	--	--	----------------	---	---------

TRIM PACKERS

5mm Strut Trim Packer	Nitro Gas / Foam Cell	HILFR05 / HILFR05F	2	\$26.14
10mm Strut Trim Packer	Nitro Gas / Foam Cell	HILFR10 / HILFR10F	2	\$26.14
15mm Strut Trim Packer	Nitro Gas / Foam Cell	HILFR15 / HILFR15F	2	\$26.14

• ONLY Compatible with Ironman 4x4 Struts (except Pro), lift height subject to 2:1 motion ratio. Unnecessary fitment may lift vehicle too high

CONTROL ARMS

Pro-Forge Upper Control Arms			UCA054FA	1	\$831.60
------------------------------	--	--	-----------------	---	----------

SPACER KIT

Sway Bar Relocation Kit			1203K	1	\$91.48
-------------------------	--	--	--------------	---	---------

REAR SUSPENSION

SHOCK ABSORBER

Nitro Gas - Comfort			12095GRC	2	\$143.75
Nitro Gas - Performance			12095GR	2	\$143.75
Foam Cell - Comfort			24095FEC	2	\$209.09
Foam Cell - Performance			24095FE	2	\$209.09
Foam Cell - Professional			24095FEP	2	\$209.09
Foam Cell Pro - Comfort			45095FEC	2	\$287.50
Foam Cell Pro - Performance			45095FE	2	\$287.50
Foam Cell Pro - Professional			45095FEP	2	\$287.50

LEAF SPRINGS

	Est. Lift	Additional Load			
Light	40mm	0 - 200kg	FOR002A	2	\$352.84
Medium	45mm	0 - 300kg	FOR002B	2	\$352.84
Heavy	45mm	300kg - GVM	FOR002C	2	\$378.98

• Possible driveline vibration may occur due to increased ride height, use 1194K to reduce vibration to satisfactory level

U-BOLTS

U-Bolt Kit			417UBK	2	\$39.21
------------	--	--	---------------	---	---------

POLYURETHANE SPRING BUSHES

Bush Kit			1193UK	1	\$156.82
----------	--	--	---------------	---	----------

DRIVELINE SPACERS

Centre Bearing Spacer Kit			1194K	1	\$39.21
---------------------------	--	--	--------------	---	---------

GREASABLE SHACKLES AND PINS

Greasable Shackle			1147	2	\$52.28
Non-Greasable Pin			387-1	2	\$26.14

HELPER SPRINGS

Load Plus Helper Springs			LP3	1	\$156.82
Add-A-Leaf			ISL6010	1	\$156.82



PX Mk II
Not USA Model
2015 to 6/2018

SUSPENSION TO SUIT

Ford Ranger

PRODUCT DESCRIPTION

PART NO.

QTY Required

RETAIL ea Incl GST

SUSPENSION KIT

Light - Nitro Gas	FOR001AKG	\$1921.00
Light - Foam Cell	FOR001AKF	\$2103.95
Light - Foam Cell Pro	FOR001AKP	\$2522.13
Medium - Nitro Gas	FOR001BKG	\$1921.00
Medium - Foam Cell	FOR001BKF	\$2103.95
Medium - Foam Cell Pro	FOR001BKP	\$2522.13
Heavy - Nitro Gas	FOR001CKG	\$1973.27
Heavy - Foam Cell	FOR001CKF	\$2156.22
Heavy - Foam Cell Pro	FOR001CKP	\$2574.40

• Specify front Coil Springs when ordering

• Possible driveline vibration may occur due to increased ride height, use 1194K to reduce vibration to satisfactory level

SUSPENSION KIT CONTENTS

Shock Absorbers	Coil Springs	U-Bolts	Centre Bearing Spacer Kit
Strut Shock Absorbers	Leaf Springs	Polyurethane Spring Bushes	



OPTIONS AVAILABLE FOR THIS VEHICLE - SEE PAGE 365



PRODUCT DESCRIPTION

PART NO.

QTY
Required

RETAIL
ea Incl GST

ACCESSORIES TO SUIT FORD RANGER

STEEL WINCH BULL BARS

Commercial	BBC038	\$1569.00
Commercial Deluxe	BBCD038	\$1985.00
Polished Alloy - <i>While Stocks Last</i>	BBA038	\$2472.00
Proguard No Loop	BBT038-NL	\$1641.00
Proguard Single Loop Kit	BB038-SL	\$297.00
Proguard Triple Loop Kit	BB038-TL	\$357.00
Driving Light Patch Loom	IPL066	\$34.00

• Can also be fitted to both 2WD and 4WD models.

STEEL SIDE STEPS AND RAILS - FITS DUAL AND SINGLE CAB MODELS ONLY

Side Steps	SS054	\$851.00
Side Rails	SS054 RAIL	\$280.00
Side Steps and Rails	SSR054	\$1022.00

TOWING

Class 4 Towbar - Compatible with Factory Rear Bumper (Not Wild Track)	TB038	\$523.00
Rear Protection Towbar - Full Rear Bumper Replacement	RTB038	\$1196.00
Rear Protection Towbar Plates (Pair)	RTBPLATE001	\$131.00
Towbar Wiring Loom - Plug and Play (PX 7/11 to 4/14 only)	ITBL039	\$329.00
Towbar Wiring Loom - Plug and Play (PX 4/14 to 7/15 only)	ITBL038	\$319.00

RECOVERY POINTS - IRONMAN 4X4 BULL BAR ONLY

Recovery Points - 5000kg Rating (Pair)	IRP054	\$300.00
--	--------	----------

LOCKSAFE DRAWER SYSTEMS

Twin Drawers - 1300mm	ITD1300	\$1469.00
Single Drawer - 1300mm	ISD1300	\$891.00
Wing Kit - 1300mm*	ITDW037	\$351.00

*Designed to suit factory tubs, will not suit ute liner without modification.

SNORKEL

2.2 / 3.2L Diesel (Fits XL with side indicator)	ISNORKELO34	\$387.00
2.2 / 3.2L Diesel (Fits XLT with indicator on side mirror)	ISNORKELO34XLT	\$387.00

BATTERY TRAYS

Suits 12" Battery	IBTRAY054	\$191.00
-------------------	-----------	----------

EXHAUST SYSTEM

BigBore - 3.2L Diesel - <i>While Stocks Last</i>	IEXHAUST007	\$1300.00
--	-------------	-----------

LONG RANGE FUEL TANK

140L* - Suitable for 2.2L and 3.2L Diesel Dual Cab, Extra Cab and Single Cab	TANK007	\$1129.00
--	---------	-----------

* Usable volume may differ to the stated tank capacity

PREMIUM UNDERBODY PROTECTION

Engine Bay and Transmission - Not compatible with models fitted with DPF	UBP054	\$712.00
--	--------	----------

UNDERBODY PROTECTION

Engine Bay and Transmission	IUP014K	\$494.00
Fuel Tank	IUP014F	\$296.00

• Fuel tank protection plates are not compatible with long range fuel tanks.

Ford Ranger

PX
7/2011 to 2015

PRODUCT DESCRIPTION

PART NO.

QTY
RequiredRETAIL
ea Incl GST**CANOPY - ABS PLASTIC (SIDE LIFT UP WINDOWS AND CENTRAL LOCKING REAR DOOR) - FITS 4X4 AND 4X2 DUAL CAB MODELS**

Pre-Primed	CANOPY010-P †	\$3143.00*
Cool White (WVA) (A2W)	CANOPY010-CW	\$3743.00
Aurora Blue (WVD) (39A)	CANOPY010-AB	\$3743.00
Highlight Silver (18G)	CANOPY010-S	\$3743.00
Winning Blue (WVW)	CANOPY010-WB	\$3743.00
Magnetic Grey (WVQ)	CANOPY010-M †	\$3743.00
True Red (SWH)	CANOPY010-TR	\$3743.00
Meteor Grey (42A) (SWT)	CANOPY010-G †	\$3743.00
Frozen White (WVZ)	CANOPY010-FW †	\$3743.00
Metropolitan Grey (WVT) (36C)	CANOPY010-MG	\$3743.00
Aluminium Metallic (SWR) (38P)	CANOPY010-AM	\$3743.00
Ingot Silver (WVR)	CANOPY010-IS †	\$3743.00
Shadow Black (UO)	CANOPY010-SB †	\$3743.00
Blue Lightning (SW3)	CANOPY010-BL †	\$3743.00
Arctic White (SWU)	CANOPY010-AW †	\$3743.00
ABS Canopy Rack Feet	IRRFETABS14	\$250.00

- Includes tub strengthening bracket (CANOPY010 BRACKET)

- Colour code and build date must be confirmed for Aluminium Metallic Canopies (CANOPY010-AM)

- See Page 33 and 34 for 1.4m Roof Rack options and pricing.

- * Pre-primed canopies, plus colour coding. († With central locking)

CANOPY - SMOOTH FINISH FIBREGLASS PINNACLE (SIDE LIFT UP WINDOWS AND CENTRAL LOCKING REAR DOOR) - FITS 4X4 AND 4X2 DUAL CAB MODELS

Pre-Primed	CANFIBRE054-P	\$2783.00*
Frozen White (WVZ)	CANFIBRE054-FW	\$3297.00
Magnetic Grey (WVQ)	CANFIBRE054-M	\$3297.00
Winning Blue (WVW)	CANFIBRE054-WB	\$3297.00
Blue Lightning (SW3)	CANFIBRE054-BL	\$3297.00
Ingot Silver (WVR)	CANFIBRE054-IS	\$3297.00
Shadow Black (UP)	CANFIBRE054-SB	\$3297.00
Arctic White (SWU)	CANFIBRE054-AW	\$3297.00

- Includes tub strengthening bracket (CANOPY010 BRACKET)

- * Pre-primed canopies, plus colour coding.

TUB STRENGTHENING BRACKET

To suit all Canopies - (Must be fitted)	CANOPY010 BRACKET	\$49.00
---	-------------------	---------

SEAT COVER

Canvas Comfort - Front	ICSC038F	\$400.00
Canvas Comfort - Rear	ICSC038R	\$400.00

DIFF BREATHER KIT

Diff Breather Kit	IDIFFBRE	\$114.00
-------------------	----------	----------



LISTING
CONTINUED
OVER THE
PAGE



PRODUCT DESCRIPTION

PART NO.

QTY
RequiredRETAIL
ea Incl GST

SUSPENSION TO SUIT FORD RANGER

FRONT SUSPENSION

SHOCK ABSORBER

Nitro Gas Strut - Performance			12727GR	2	\$209.09
Foam Cell Strut - Performance			24727FE	2	\$235.23
Foam Cell Pro Strut - Performance			45727FE	2	\$365.91

• Height adjustable with Ironman 4x4 Strut Trim Packers

COIL SPRINGS

	Est. Lift	Additional Load			
Standard	0mm	0 - 50kg	FOR001S	1	\$235.23
Light	35mm	0 - 50kg	FOR001A	1	\$235.23
Medium	40mm	0 - 50kg	FOR001B	1	\$235.23
Heavy	45mm	50 - 110kg	FOR001C	1	\$235.23

STRUT MOUNTS

Steel Strut Top			ISST014	2	\$78.41
-----------------	--	--	----------------	---	---------

TRIM PACKERS

5mm Strut Trim Packer	Nitro Gas / Foam Cell	HILFR05 / HILFR05F	2	\$26.14
10mm Strut Trim Packer	Nitro Gas / Foam Cell	HILFR10 / HILFR10F	2	\$26.14
15mm Strut Trim Packer	Nitro Gas / Foam Cell	HILFR15 / HILFR15F	2	\$26.14

• ONLY Compatible with Ironman 4x4 Struts (except Pro), lift height subject to 2:1 motion ratio. Unnecessary fitment may lift vehicle too high

CONTROL ARMS

Pro-Forge Upper Control Arms			UCA054FA	1	\$831.60
------------------------------	--	--	-----------------	---	----------

SPACER KIT

Sway Bar Relocation Kit			1203K	1	\$91.48
-------------------------	--	--	--------------	---	---------

REAR SUSPENSION

SHOCK ABSORBER

Nitro Gas - Comfort			12095GRC	2	\$143.75
Nitro Gas - Performance			12095GR	2	\$143.75
Foam Cell - Comfort			24095FEC	2	\$209.09
Foam Cell - Performance			24095FE	2	\$209.09
Foam Cell - Professional			24095FEP	2	\$209.09
Foam Cell Pro - Comfort			45095FEC	2	\$287.50
Foam Cell Pro - Performance			45095FE	2	\$287.50
Foam Cell Pro - Professional			45095FEP	2	\$287.50

LEAF SPRINGS

	Est. Lift	Additional Load			
Light	40mm	0 - 200kg	FOR002A	2	\$352.84
Medium	45mm	0 - 300kg	FOR002B	2	\$352.84
Heavy	45mm	300kg - GVM	FOR002C	2	\$378.98

• Possible driveline vibration may occur due to increased ride height, use 1194K to reduce vibration to satisfactory level

U-BOLTS

U-Bolt Kit			417UBK	2	\$39.21
------------	--	--	---------------	---	---------

POLYURETHANE SPRING BUSHES

Bush Kit			1193UK	1	\$156.82
----------	--	--	---------------	---	----------

DRIVELINE SPACERS

Centre Bearing Spacer Kit			1194K	1	\$39.21
---------------------------	--	--	--------------	---	---------

GREASABLE SHACKLES AND PINS

Greasable Shackle			1147	2	\$52.28
Non-Greasable Pin			387-1	2	\$26.14

HELPER SPRINGS

Load Plus Helper Springs			LP3	1	\$156.82
Add-A-Leaf			ISL6010	1	\$156.82





T6 PX
Not USA Model
2011 to 2015

SUSPENSION TO SUIT

Ford Ranger

PRODUCT DESCRIPTION

PART NO.

QTY
Required

RETAIL
ea Incl GST

SUSPENSION KIT

Light - Nitro Gas	FOR001AKG	\$1921.00
Light - Foam Cell	FOR001AKF	\$2103.95
Light - Foam Cell Pro	FOR001AKP	\$2522.13
Medium - Nitro Gas	FOR001BKG	\$1921.00
Medium - Foam Cell	FOR001BKF	\$2103.95
Medium - Foam Cell Pro	FOR001BKP	\$2522.13
Heavy - Nitro Gas	FOR001CKG	\$1973.27
Heavy - Foam Cell	FOR001CKF	\$2156.22
Heavy - Foam Cell Pro	FOR001CKP	\$2574.40

• Specify front Coil Springs when ordering

• Possible driveline vibration may occur due to increased ride height, use 1194K to reduce vibration to satisfactory level

SUSPENSION KIT CONTENTS

Shock Absorbers	Coil Springs	U-Bolts	Centre Bearing Spacer Kit
Strut Shock Absorbers	Leaf Springs	Polyurethane Spring Bushes	



OPTIONS AVAILABLE FOR THIS VEHICLE - SEE PAGE 365



PRODUCT DESCRIPTION

PART NO.

QTY
RequiredRETAIL
ea Incl GST

ACCESSORIES TO SUIT FORD RANGER

STEEL WINCH BULL BARS

Commercial Deluxe	BBCD014	\$1985.00
Protector - <i>While Stocks Last</i>	BBT014	\$2009.00

• Can also be fitted to both 2WD and 4WD models.

STEEL SIDE STEPS AND RAILS - FITS DUAL AND SINGLE CAB MODELS ONLY

Side Steps	SS008	\$851.00
Side Steps and Rails	SSR002	\$1022.00

LOCKSAFE DRAWER SYSTEMS - FITS DUAL AND EXTRA CAB

Twin Drawers - 1300mm	ITD1300	\$1469.00
Single Drawer - 1300mm	ISD1300	\$891.00

SNORKEL

3.0L TDi Diesel	ISNORKEL021	\$387.00
-----------------	-------------	----------

EXHAUST SYSTEM - DIESEL ONLY

BigBore - (Automatic Transmission) - Diesel Only - <i>While Stocks Last</i>	IEXHAUST014	\$1300.00
BigBore - (Manual Transmission) - <i>While Stocks Last</i>	IEXHAUST015	\$1300.00

LONG RANGE FUEL TANK

122L* Fits Dual and Single Cab only	TANK006	\$1129.00
-------------------------------------	---------	-----------

* Usable volume may differ to the stated tank capacity

UNDERBODY PROTECTION

Engine Bay and Transmission	IUP008K	\$437.00
-----------------------------	---------	----------

CANOPY - ABS PLASTIC (SIDE LIFT UP WINDOWS) - FITS 4X4 AND 4X2 DUAL CAB MODELS

Pre-Primed	CANOPY004-P	\$3143.00*
Ranger White (A2W)	CANOPY004-W	\$3743.00

* Pre-primed canopies, plus colour coding.

DIFF BREATHER KIT

Diff Breather Kit	IDIFFBRE	\$114.00
-------------------	----------	----------



Ford Ranger

PJ / PK
Not USA Model
3/2006 to 2011

PRODUCT DESCRIPTION

PART NO.

QTY
RequiredRETAIL
ea Incl GST

SUSPENSION TO SUIT FORD RANGER

FRONT SUSPENSION

SHOCK ABSORBER

Nitro Gas - Performance		12667GR	2	\$143.75
Foam Cell - Performance		24667FE	2	\$209.09
Foam Cell Pro - Performance		45667FE	2	\$287.50

TORSION BAR

Uprated Torsion Bars	Duratorq Engine	MAZDA014	1	\$392.04
Uprated Torsion Bars	2.5L WLT Engine	MAZDA005	1	\$392.04

- MAZDA014 is 1024mm in length, used on most vehicles. Vehicles with 2.5L WLT Engine use MAZDA005 (924mm) Torsion Bar
- Minimum 60mm downward suspension travel required after adjustment

REAR SUSPENSION

SHOCK ABSORBER

Nitro Gas - Comfort		12095GRC	2	\$143.75
Nitro Gas - Performance		12095GR	2	\$143.75
Foam Cell - Comfort		24095FEC	2	\$209.09
Foam Cell - Performance		24095FE	2	\$209.09
Foam Cell Pro - Comfort		45095FEC	2	\$287.50
Foam Cell Pro - Performance		45095FE	2	\$287.50

LEAF SPRINGS

	Est. Lift	Additional Load			
Light	40mm	0 - 100kg	MAZDA041A	2	\$352.84
Medium	40mm	0 - 200kg	MAZDA041B	2	\$352.84
Heavy	40mm	200 - 400kg	MAZDA041C	2	\$378.98
Extra Heavy	40mm	400kg - GVM	MAZDA041D	2	\$378.98

U-BOLTS

U-Bolt Kit		417UBK	2	\$39.21
------------	--	---------------	---	---------

POLYURETHANE SPRING BUSHES

Bush Kit		759UK	1	\$78.41
----------	--	--------------	---	---------

GREASABLE SHACKLES AND PINS

Greasable Shackle		386-1	2	\$52.28
-------------------	--	--------------	---	---------

HELPER SPRINGS

Load Plus Helper Springs		LP3	1	\$156.82
Add-A-Leaf		ISL6010	1	\$156.82

SUSPENSION KIT

Light - Nitro Gas		MAZDA041AKG		\$1829.52
Light - Foam Cell		MAZDA041AKF		\$2090.88
Light - Foam Cell Pro		MAZDA041AKP		\$2404.52
Medium - Nitro Gas		MAZDA041BKG		\$1829.52
Medium - Foam Cell		MAZDA041BKF		\$2090.88
Medium - Foam Cell Pro		MAZDA041BKP		\$2404.52
Heavy - Nitro Gas		MAZDA041CKG		\$1881.80
Heavy - Foam Cell		MAZDA041CKF		\$2143.16
Heavy - Foam Cell Pro		MAZDA041CKP		\$2456.79
Extra Heavy - Nitro Gas		MAZDA041DKG		\$1881.80
Extra Heavy - Foam Cell		MAZDA041DKF		\$2143.16
Extra Heavy - Foam Cell Pro		MAZDA041DKP		\$2456.79

- Check Torsion Bar length before ordering.

SUSPENSION KIT CONTENTS

Shock Absorbers	Torsion Bars	Polyurethane Spring Bushes
Leaf Springs	U-Bolts	

Ford Courier Ranger

Not USA Model
1985 to 2006



PRODUCT DESCRIPTION

PART NO.

QTY
Required

RETAIL
ea Incl GST

SUSPENSION TO SUIT FORD COURIER

FRONT SUSPENSION

SHOCK ABSORBER

Nitro Gas - Performance	12667GR	2	\$143.75
Foam Cell - Performance	24667FE	2	\$209.09
Foam Cell Pro - Performance	45667FE	2	\$287.50

TORSION BAR

Upated Torsion Bars	MAZDA005	1	\$392.04
---------------------	----------	---	----------

• Minimum 60mm downward suspension travel required after adjustment

REAR SUSPENSION

SHOCK ABSORBER

Nitro Gas - Comfort	12095GRC	2	\$143.75
Nitro Gas - Performance	12095GR	2	\$143.75
Foam Cell - Comfort	24095FEC	2	\$209.09
Foam Cell - Performance	24095FE	2	\$209.09
Foam Cell - Professional	24095FEP	2	\$209.09
Foam Cell Pro - Comfort	45095FEC	2	\$287.50
Foam Cell Pro - Performance	45095FE	2	\$287.50
Foam Cell Pro - Professional	45095FEP	2	\$287.50

LEAF SPRINGS

	Est. Lift	Additional Load			
Light	40mm	0 - 100kg	MAZDA006A	2	\$352.84
Medium	40mm	0 - 200kg	MAZDA006B	2	\$352.84
Heavy	40mm	200 - 400kg	MAZDA006C	2	\$352.84
Extra Heavy	40mm	400kg - GVM	MAZDA006D	2	\$378.98

U-BOLTS

U-Bolt Kit	415UBK	2	\$39.21
------------	--------	---	---------

POLYURETHANE SPRING BUSHES

Bush Kit	756UK	1	\$78.41
----------	-------	---	---------

GREASABLE SHACKLES AND PINS

Greasable Shackle	386-1	2	\$52.28
Greasable Pin	794	2	\$39.21

HELPER SPRINGS

Load Plus Helper Springs	LP3	1	\$156.82
Add-A-Leaf	ISL6010	1	\$156.82

SUSPENSION KIT

Light - Nitro Gas	MAZDA006AKG	\$1829.52
Light - Foam Cell	MAZDA006AKF	\$2090.88
Light - Foam Cell Pro	MAZDA006AKP	\$2404.52
Medium - Nitro Gas	MAZDA006BKG	\$1829.52
Medium - Foam Cell	MAZDA006BKF	\$2090.88
Medium - Foam Cell Pro	MAZDA006BKP	\$2404.52
Heavy - Nitro Gas	MAZDA006CKG	\$1829.52
Heavy - Foam Cell	MAZDA006CKF	\$2090.88
Heavy - Foam Cell Pro	MAZDA006CKP	\$2404.52
Extra Heavy - Nitro Gas	MAZDA006DKG	\$1881.80
Extra Heavy - Foam Cell	MAZDA006DKF	\$2143.16
Extra Heavy - Foam Cell Pro	MAZDA006DKP	\$2456.79

SUSPENSION KIT CONTENTS

Shock Absorbers
Leaf Springs

Torsion Bars
U-Bolts

Polyurethane Spring Bushes





UAll 7/2018+
WITH or WITHOUT Tech Pack
Adaptive Cruise Control

ACCESSORIES TO SUIT

Ford Everest

PRODUCT DESCRIPTION

PART NO.

QTY
Required

RETAIL
ea Incl GST

ACCESSORIES TO SUIT FORD EVEREST

STEEL WINCH BULL BARS

Commercial - With parking sensor provisions Without Tech Pack	BBC055	\$1598.00
Commercial Deluxe - With parking sensor provisions Without Tech Pack	BBCD055	\$2021.00
Commercial Deluxe - With or Without Tech Pack	BBCD066	\$2021.00
Proguard No Loop - With or Without Tech Pack	BBT066-NL	\$1670.00
Proguard Single Loop Kit	BB066-SL	\$297.00
Proguard Triple Loop Kit	BB066-TL	\$357.00
Driving Light Patch Loom	IPL066	\$34.00

• Winch with Steel Cable and Roller Fairlead is not suitable for use with BBCD066 and BBT066 - Use Winch with Synthetic Rope and Alloy Hawse only
 • Can also be fitted to both 2WD and 4WD models.

STEEL SIDE STEPS AND RAILS

Side Steps	SS055	\$851.00
Side Rails	SS055 RAIL	\$280.00
Side Steps and Rails	SSR055	\$1022.00

RECOVERY POINTS - IRONMAN 4X4 BULL BAR ONLY

Recovery Points - 5000kg Rating (Pair)	IRP054	\$300.00
--	---------------	----------

PREMIUM UNDERBODY PROTECTION

Engine Bay and Transmission - DPF Models (Retains factory transmission plate)	UBP055	\$500.00
---	---------------	----------

SEAT COVER

Canvas Comfort - Front	ICSC054F	\$400.00
Canvas Comfort - Rear	ICSC054R	\$400.00

DIFF BREATHER KIT

Diff Breather Kit	IDIFFBRE	\$114.00
-------------------	-----------------	----------

**LISTING
CONTINUED
OVER THE
PAGE**





PRODUCT DESCRIPTION

PART NO.

QTY
Required

RETAIL
ea Incl GST

SUSPENSION TO SUIT FORD EVEREST

FRONT SUSPENSION

SHOCK ABSORBER

Nitro Gas Strut - Performance			12827GR	2	\$209.09
Foam Cell Strut - Performance			24827FE	2	\$235.23
Foam Cell Pro Strut - Performance			45827FE	2	\$365.91

• Height adjustable with Ironman 4x4 Strut Trim Packers

COIL SPRINGS

	Est. Lift	Additional Load			
Standard	0mm	0 - 50kg	FOR005S	1	\$235.23
Medium	40mm	0 - 50kg	FOR005A	1	\$235.23
Heavy	45mm	50 - 110kg	FOR005B	1	\$235.23

STRUT MOUNTS

Steel Strut Top			ISST055	2	\$91.48
Bump Stop Base Holder			PBC055	2	\$21.78

TRIM PACKERS

5mm Strut Trim Packer		Foam Cell	HILFR05F	2	\$26.14
10mm Strut Trim Packer		Foam Cell	HILFR10F	2	\$26.14
15mm Strut Trim Packer		Foam Cell	HILFR15F	2	\$26.14

• ONLY Compatible with Ironman 4x4 Struts (except Pro), lift height subject to 2:1 motion ratio. Unnecessary fitment may lift vehicle too high

SWAY BAR LINK

Adjustable Sway Bar Link			1214K	2	\$72.60
--------------------------	--	--	--------------	---	---------

CONTROL ARMS

Pro-Forge Upper Control Arms			UCA054FA	1	\$831.60
------------------------------	--	--	-----------------	---	----------

REAR SUSPENSION

SHOCK ABSORBER

Nitro Gas - Performance ¹			12732GR	2	\$143.75
Foam Cell - Performance ¹			24732FE	2	\$209.09
Foam Cell Pro - Performance ²			45732FE	2	\$287.50

¹ Refit original bump stop and shock absorber dust cover.

² Refit original bump stop with supplied Ironman 4x4 dust boot.

COIL SPRINGS

	Est. Lift	Additional Load			
Medium	45mm	0 - 300kg	FOR003B	1	\$274.43
Heavy	45mm	300kg - GVM	FOR003C	1	\$274.43

SUSPENSION KIT

Medium - Nitro Gas	FOR003BKG1	\$1215.33
Medium - Foam Cell	FOR003BKF1	\$1398.28
Medium - Foam Cell Pro	FOR003BKP1	\$1816.46
Heavy - Nitro Gas	FOR003CKG1	\$1215.33
Heavy - Foam Cell	FOR003CKF1	\$1398.28
Heavy - Foam Cell Pro	FOR003CKP1	\$1816.46

• Specify front Coil Springs when ordering

SUSPENSION KIT CONTENTS

Shock Absorbers

Strut Shock Absorbers

Coil Springs





9/2015 to 6/2018
 WITH or WITHOUT Tech Pack
 Adaptive Cruise Control

PRODUCT DESCRIPTION

PART NO.

QTY
Required

RETAIL
ea Incl GST

ACCESSORIES TO SUIT FORD EVEREST

STEEL WINCH BULL BARS

Commercial - With parking sensor provisions Without Tech Pack	BBC055	\$1598.00
Commercial Deluxe - With parking sensor provisions Without Tech Pack	BBCD055	\$2021.00
Commercial Deluxe - With or Without Tech Pack	BBCD054	\$2021.00
Proguard No Loop - With or Without Tech Pack	BBT054-NL	\$1670.00
Proguard Single Loop Kit	BB054-SL	\$297.00
Proguard Triple Loop Kit	BB054-TL	\$357.00
Driving Light Patch Loom	IPL066	\$34.00

• Can also be fitted to both 2WD and 4WD models.

STEEL SIDE STEPS AND RAILS

Side Steps	SS055	\$851.00
Side Rails	SS055 RAIL	\$280.00
Side Steps and Rails	SSR055	\$1022.00

RECOVERY POINTS - IRONMAN 4X4 BULL BAR ONLY

Recovery Points - 5000kg Rating (Pair)	IRP054	\$300.00
--	---------------	----------

PREMIUM UNDERBODY PROTECTION

Engine Bay and Transmission	UBP054	\$712.00
-----------------------------	---------------	----------

UNDERBODY PROTECTION

Engine Bay and Transmission	IUP014K	\$494.00
-----------------------------	----------------	----------

SEAT COVER

Canvas Comfort - Front	ICSC054F	\$400.00
Canvas Comfort - Rear	ICSC054R	\$400.00

DIFF BREATHER KIT

Diff Breather Kit	IDIFFBRE	\$114.00
-------------------	-----------------	----------

**LISTING
CONTINUED
OVER THE
PAGE**





PRODUCT DESCRIPTION

PART NO.

QTY
Required

RETAIL
ea Incl GST

SUSPENSION TO SUIT FORD EVEREST

FRONT SUSPENSION

SHOCK ABSORBER

Nitro Gas Strut - Performance			12727GR	2	\$209.09
Foam Cell Strut - Performance			24727FE	2	\$235.23
Foam Cell Pro Strut - Performance			45727FE	2	\$365.91

• Height adjustable with Ironman 4x4 Strut Trim Packers

COIL SPRINGS

	Est. Lift	Additional Load			
Standard	0mm	0 - 50kg	FOR001S	1	\$235.23
Medium	40mm	0 - 50kg	FOR001A	1	\$235.23
Heavy	40mm	50 - 100kg	FOR001B	1	\$235.23

STRUT MOUNTS

Steel Strut Top			ISST014	2	\$78.41
-----------------	--	--	----------------	---	---------

TRIM PACKERS

5mm Strut Trim Packer	Nitro Gas / Foam Cell	HILFR05 / HILFR05F	2	\$26.14
10mm Strut Trim Packer	Nitro Gas / Foam Cell	HILFR10 / HILFR10F	2	\$26.14
15mm Strut Trim Packer	Nitro Gas / Foam Cell	HILFR15 / HILFR15F	2	\$26.14

• ONLY Compatible with Ironman 4x4 Struts (except Pro), lift height subject to 2:1 motion ratio. Unnecessary fitment may lift vehicle too high

CONTROL ARMS

Pro-Forge Upper Control Arms			UCA054FA	1	\$831.60
------------------------------	--	--	-----------------	---	----------

REAR SUSPENSION

SHOCK ABSORBER

Nitro Gas - Performance ¹			12732GR	2	\$143.75
Foam Cell - Performance ¹			24732FE	2	\$209.09
Foam Cell Pro - Performance ²			45732FE	2	\$287.50

¹ Refit original bump stop and shock absorber dust cover.

² Refit original bump stop with supplied Ironman 4x4 dust boot.

COIL SPRINGS

	Est. Lift	Additional Load			
Medium	45mm	0 - 300kg	FOR003B	1	\$274.43
Heavy	45mm	300kg - GVM	FOR003C	1	\$274.43

SUSPENSION KIT

Medium - Nitro Gas	FOR003BKG	\$1215.33
Medium - Foam Cell	FOR003BKF	\$1398.28
Medium - Foam Cell Pro	FOR003BKP	\$1816.46
Heavy - Nitro Gas	FOR003CKG	\$1215.33
Heavy - Foam Cell	FOR003CKF	\$1398.28
Heavy - Foam Cell Pro	FOR003CKP	\$1816.46

• Specify front Coil Springs when ordering

SUSPENSION KIT CONTENTS

Shock Absorbers

Strut Shock Absorbers

Coil Springs



Haval H9

Wagon 2.0L Petrol
8/2017+

PRODUCT DESCRIPTION

PART NO.

QTY
RequiredRETAIL
ea Incl GST

SUSPENSION TO SUIT HAVAL H9

FRONT SUSPENSION

SHOCK ABSORBER

Nitro Gas Strut - Performance			12710GR	2	\$209.09
Foam Cell Strut - Performance			24710FE	2	\$235.23

- Height adjustable with Ironman 4x4 Strut Trim Packers

COIL SPRINGS

	Est. Lift	Additional Load			
Medium	40mm	0 - 50kg	TOY055C	1	\$235.23
Heavy	40mm	50 - 110kg	TOY065B	1	\$235.23

STRUT MOUNTS

Steel Strut Top			ISST001	2	\$78.41
-----------------	--	--	----------------	---	---------

TRIM PACKERS

5mm Strut Trim Packer	Nitro Gas / Foam Cell	HILFR05 / HILFR05F	2	\$26.14
10mm Strut Trim Packer	Nitro Gas / Foam Cell	HILFR10 / HILFR10F	2	\$26.14
15mm Strut Trim Packer	Nitro Gas / Foam Cell	HILFR15 / HILFR15F	2	\$26.14

- ONLY Compatible with Ironman 4x4 Struts (except Pro), lift height subject to 2:1 motion ratio. Unnecessary fitment may lift vehicle too high

REAR SUSPENSION

SHOCK ABSORBER

Nitro Gas - Performance			12804GR	2	\$143.75
Foam Cell - Performance			24804FE	2	\$209.09

COIL SPRINGS

	Est. Lift	Additional Load			
Medium	40mm	0 - 200kg	TOY056A	1	\$235.23
Heavy	40mm	200 - 400kg	TOY056B	1	\$235.23
Extra Heavy	40mm	400kg - GVM	TOY056C	1	\$235.23

SUSPENSION KIT

Medium - Nitro Gas	TOY056AKG	\$1176.12
Medium - Foam Cell	TOY056AKF	\$1359.08
Heavy - Nitro Gas	TOY056BKG	\$1176.12
Heavy - Foam Cell	TOY056BKF	\$1359.08
Extra Heavy - Nitro Gas	TOY056CKG	\$1176.12
Extra Heavy - Foam Cell	TOY056CKF	\$1359.08

- Specify front Coil Springs when ordering

SUSPENSION KIT CONTENTS

Shock Absorbers

Strut Shock Absorbers

Coil Springs



PRODUCT DESCRIPTION

PART NO.

QTY
Required

RETAIL
ea Incl GST

SUSPENSION TO SUIT HOLDEN / GM JACKAROO

FRONT SUSPENSION

SHOCK ABSORBER

Nitro Gas - Performance	12643GR	2	\$143.75
Foam Cell - Performance	24643FE	2	\$209.09

TORSION BAR

Up-rated Torsion Bars	HOLD009	1	\$392.04
-----------------------	----------------	---	----------

• Minimum 60mm downward suspension travel required after adjustment

REAR SUSPENSION

SHOCK ABSORBER

Nitro Gas - Performance	12644GR	2	\$143.75
Foam Cell - Performance	24644FE	2	\$209.09

COIL SPRINGS

	Est. Lift	Additional Load			
Medium	40mm	0 - 300kg	HOLD008B	1	\$235.23
Heavy	40mm	300kg - GVM	HOLD008C	1	\$235.23

• Use HOLD008C for 3/2001+ Models

SUSPENSION KIT

Medium - Nitro Gas	HOLD008BKG	\$1202.26
Medium - Foam Cell	HOLD008BKF	\$1463.62
Heavy - Nitro Gas	HOLD008CKG	\$1202.26
Heavy - Foam Cell	HOLD008CKF	\$1463.62

SUSPENSION KIT CONTENTS

Shock Absorbers Coil Springs Torsion Bars





11/1986 to 1991

Holden / GM Jackaroo

PRODUCT DESCRIPTION

PART NO.

QTY
Required

RETAIL
ea Incl GST

SUSPENSION TO SUIT HOLDEN / GM JACKAROO

FRONT SUSPENSION

SHOCK ABSORBER

Nitro Gas - Performance		12087GR	2	\$143.75
Foam Cell - Performance		24087FE	2	\$209.09

TORSION BAR

Uprated Torsion Bars	33mm Spline	HOLD005A	1	\$392.04
Uprated Torsion Bars	33mm Spline	HOLD007	1	\$653.40

• Minimum 60mm downward suspension travel required after adjustment

REAR SUSPENSION

SHOCK ABSORBER

Nitro Gas - Performance		12671GR	2	\$143.75
-------------------------	--	----------------	---	----------

LEAF SPRINGS

	Est. Lift	Additional Load			
Medium - Drivers Side	40mm	0 - 300kg	HOLD004BD/S	1	\$352.84
Medium - Near Side	40mm	0 - 300kg	HOLD004BN/S	1	\$352.84
Heavy - Drivers Side	40mm	300kg - GVM	HOLD004CD/S	1	\$378.98
Heavy - Near Side	40mm	300kg - GVM	HOLD004CN/S	1	\$378.98

U-BOLTS

U-Bolt Kit		451UBK	2	\$39.21
------------	--	---------------	---	---------

POLYURETHANE SPRING BUSHES

Bush Kit		747UK	1	\$78.41
----------	--	--------------	---	---------

GREASABLE SHACKLES AND PINS

Greasable Shackle		791	2	\$52.28
Greasable Pin		792	2	\$39.21

HELPER SPRINGS

Load Plus Helper Springs		LP3	1	\$156.82
Add-A-Leaf		ISL6010	1	\$156.82

SUSPENSION KIT

Medium - Nitro Gas		HOLD007BKG		\$2090.88
Medium - Foam Cell		HOLD007BKF		\$2221.56
Heavy - Nitro Gas		HOLD007CKG		\$1761.57
Heavy - Foam Cell		HOLD007CKF		\$2273.84

SUSPENSION KIT CONTENTS

Shock Absorbers	Torsion Bars	Polyurethane Spring Bushes
Leaf Springs	U-Bolts	





PRODUCT DESCRIPTION

PART NO.

QTY
Required

RETAIL
ea Incl GST

SUSPENSION TO SUIT HOLDEN / GM JACKAROO

FRONT SUSPENSION

SHOCK ABSORBER

Nitro Gas - Performance		12087GR	2	\$143.75
Foam Cell - Performance		24087FE	2	\$209.09

TORSION BAR

Uprated Torsion Bars		MAZDA005	1	\$392.04
----------------------	--	-----------------	---	----------

• Minimum 60mm downward suspension travel required after adjustment

REAR SUSPENSION

SHOCK ABSORBER

Nitro Gas - Comfort		12636GRC	2	\$143.75
Nitro Gas - Performance		12636GR	2	\$143.75
Foam Cell - Comfort		24636FEC	2	\$209.09
Foam Cell - Performance		24636FE	2	\$209.09

LEAF SPRINGS

	Est. Lift	Additional Load		
Medium - Drivers Side	40mm	0 - 300kg	HOLD004BD/S	\$352.84
Medium - Near Side	40mm	0 - 300kg	HOLD004BN/S	\$352.84
Heavy - Drivers Side	40mm	300kg - GVM	HOLD004CD/S	\$378.98
Heavy - Near Side	40mm	300kg - GVM	HOLD004CN/S	\$378.98

U-BOLTS

U-Bolt Kit		451UBK	2	\$39.21
------------	--	---------------	---	---------

POLYURETHANE SPRING BUSHES

Bush Kit		747UK	1	\$78.41
----------	--	--------------	---	---------

GREASABLE SHACKLES AND PINS

Greasable Shackle		791	2	\$52.28
Greasable Pin		792	2	\$39.21

HELPER SPRINGS

Load Plus Helper Springs		LP3	1	\$156.82
Add-A-Leaf		ISL6010	1	\$156.82

SUSPENSION KIT

Medium - Nitro Gas		HOLD005BKG		\$1829.52
Medium - Foam Cell		HOLD005BKF		\$2090.88
Heavy - Nitro Gas		HOLD005CKG		\$1881.80
Heavy - Foam Cell		HOLD005CKF		\$2143.16

SUSPENSION KIT CONTENTS

Shock Absorbers	Torsion Bars	Polyurethane Spring Bushes
Leaf Springs	U-Bolts	





1995 to 1/1999

Holden / GM Frontera

PRODUCT DESCRIPTION

PART NO.

QTY
Required

RETAIL
ea Incl GST

SUSPENSION TO SUIT HOLDEN / GM JACKAROO

FRONT SUSPENSION

SHOCK ABSORBER

Nitro Gas - Performance	12667GR	2	\$143.75
Foam Cell - Performance	24667FE	2	\$209.09

TORSION BAR

Uprated Torsion Bars	HOLD009	1	\$392.04
----------------------	----------------	---	----------

• Minimum 60mm downward suspension travel required after adjustment

REAR SUSPENSION

SHOCK ABSORBER

Nitro Gas - Performance	12644GR	2	\$143.75
Foam Cell - Performance	24644FE	2	\$209.09

COIL SPRINGS

	Est. Lift	Additional Load		
Medium	45mm	0 - 300kg	HOLD008B	1
Heavy	45mm	300kg - GVM	HOLD008C	1

SUSPENSION KIT

Medium - Nitro Gas	HOLD008BKG1	\$1202.26
Medium - Foam Cell	HOLD008BKF1	\$1463.62
Heavy - Nitro Gas	HOLD008CKG1	\$1202.26
Heavy - Foam Cell	HOLD008CKF1	\$1463.62

SUSPENSION KIT CONTENTS

Shock Absorbers Coil Springs Torsion Bars





PRODUCT DESCRIPTION

PART NO.

QTY
RequiredRETAIL
ea Incl GST

ACCESSORIES TO SUIT HOLDEN / GM TRAILBLAZER

STEEL WINCH BULL BARS

Commercial	BBC057	\$1598.00
Commercial Deluxe	BBCD057	\$2021.00
Proguard No Loop	BBT057-NL	\$1670.00
Proguard Single Loop Kit	BB057-SL	\$297.00
Proguard Triple Loop Kit	BB057-TL	\$357.00
Driving Light Patch Loom	IPL057	\$30.00

• Can also be fitted to both 2WD and 4WD models.

STEEL SIDE STEPS AND RAILS - FITS DUAL CAB MODELS ONLY

Side Steps	SS044	\$851.00
Side Rails	SS044 RAIL	\$280.00
Side Steps and Rails	SSR044	\$1022.00

RECOVERY POINTS - IRONMAN 4X4 BULL BAR ONLY

Recovery Points (One piece, two points) - 5000kg rating	IRP057	\$350.00
Recovery Points - 5000kg Rating (Pair)	IRP058	\$286.00

SNORKEL

Trailblazer LT/LTZ 2017+	ISNORKELO36	\$387.00
--------------------------	-------------	----------

PREMIUM UNDERBODY PROTECTION

Engine Bay and Transmission	UBP057	\$712.00
-----------------------------	--------	----------

STEEL ROOF RACKS

Cage Style - 1.8 x 1.25m	IRRCAGE18	\$744.00
Rooftop Tent Compatible - 1.8 x 1.25m	IRRTENT18	\$709.00
Trade Style - 1.8m x 1.25m (Open end)	IRRTRADE18	\$709.00

ALLOY ROOF RACKS

Cage Style - 1.8m x 1.25m	IRRCAGE18-ALLOY	\$1049.00
Trade Style - 1.8m x 1.25m (Open end)	IRRTRADE18-ALLOY	\$1033.00
Flat Rack - 1.8m x 1.25m	IRRTFLAT18-ALLOY	\$1019.00

ROOF RACK - MOUNTING KITS

Mount Feet (6 Feet) - Suits OE rails	IRRFEE001	\$180.00
--------------------------------------	-----------	----------

SEAT COVER

Canvas Comfort - Front	ICSC040F	\$400.00
Canvas Comfort - Rear	ICSC049R	\$400.00

DIFF BREATHER KIT

Diff Breather Kit	IDIFFBRE	\$114.00
-------------------	----------	----------





LT / LTZ
2017+

Holden / GM Trailblazer

PRODUCT DESCRIPTION

PART NO.

QTY Required

RETAIL ea Incl GST

SUSPENSION TO SUIT HOLDEN / GM TRAILBLAZER

FRONT SUSPENSION

SHOCK ABSORBER

Nitro Gas Strut - Performance			12745GR	2	\$209.09
Foam Cell Strut - Performance			24745FE	2	\$235.23
Foam Cell Pro Strut - Performance			45745FE	2	\$365.91

• Height adjustable with Ironman 4x4 Strut Trim Packers

COIL SPRINGS

	Est. Lift	Additional Load			
Standard	0mm	0 - 50kg	HOLD020S	1	\$235.23
Light	30mm	0 - 50kg	HOLD020A	1	\$235.23
Medium	40mm	0 - 50kg	HOLD020B	1	\$235.23
Heavy	40mm	50 - 110kg	HOLD020C	1	\$235.23

STRUT MOUNTS

Steel Strut Top			ISST017	2	\$78.41
-----------------	--	--	----------------	---	---------

TRIM PACKERS

5mm Strut Trim Packer	Nitro Gas / Foam Cell	HILFR05 / HILFR05F	2	\$26.14
10mm Strut Trim Packer	Nitro Gas / Foam Cell	HILFR10 / HILFR10F	2	\$26.14
15mm Strut Trim Packer	Nitro Gas / Foam Cell	HILFR15 / HILFR15F	2	\$26.14

• ONLY Compatible with Ironman 4x4 Struts (except Pro), lift height subject to 2:1 motion ratio. Unnecessary fitment may lift vehicle too high

CONTROL ARMS

Pro-Forge Upper Control Arms			UCA041FA	1	\$831.60
------------------------------	--	--	-----------------	---	----------

REAR SUSPENSION

SHOCK ABSORBER

Nitro Gas - Comfort			12746GRC	2	\$143.75
Nitro Gas - Performance			12746GR	2	\$143.75
Foam Cell - Comfort			24746FEC	2	\$209.09
Foam Cell - Performance			24746FE	2	\$209.09
Foam Cell Pro - Comfort			45746FEC	2	\$287.50
Foam Cell Pro - Performance			45746FE	2	\$287.50

COIL SPRINGS

	Est. Lift	Additional Load			
Standard	0mm	0 - 250kg	HOLD022S	1	\$235.23
Light	30mm	0 - 250kg	HOLD022A	1	\$235.23
Medium	40mm	0 - 250kg	HOLD022B	1	\$235.23
Heavy	45mm	250kg - GVM	HOLD022C	1	\$235.23

SUSPENSION KIT

Standard - Nitro Gas	HOLD022SKG	\$1176.12
Standard - Foam Cell	HOLD022SKF	\$1359.08
Standard - Foam Cell Pro	HOLD022SKP	\$1777.25
Light - Nitro Gas	HOLD022AKG	\$1176.12
Light - Foam Cell	HOLD022AKF	\$1359.08
Light - Foam Cell Pro	HOLD022AKP	\$1777.25
Medium - Nitro Gas	HOLD022BKG	\$1176.12
Medium - Foam Cell	HOLD022BKF	\$1359.08
Medium - Foam Cell Pro	HOLD022BKP	\$1777.25
Heavy - Nitro Gas	HOLD022CKG	\$1176.12
Heavy - Foam Cell	HOLD022CKF	\$1359.08
Heavy - Foam Cell Pro	HOLD022CKP	\$1777.25

• Specify front Coil Springs when ordering

SUSPENSION KIT CONTENTS

Shock Absorbers

Strut Shock Absorbers

Coil Springs



PRODUCT DESCRIPTION

PART NO.

QTY
Required

RETAIL
ea Incl GST

ACCESSORIES TO SUIT HOLDEN / GM COLORADO 7

STEEL WINCH BULL BARS

Commercial Deluxe	BBCD044	\$1985.00
Protector - <i>While Stocks Last</i>	BBT044	\$2009.00

• Can also be fitted to both 2WD and 4WD models.

STEEL SIDE STEPS AND RAILS

Side Steps	SS044	\$851.00
Side Rails	SS044 RAIL	\$280.00
Side Steps and Rails	SSR044	\$1022.00

RECOVERY POINTS - IRONMAN 4X4 BULL BAR ONLY

Recovery Points - 5000kg Rating (Pair)	IRP058	\$286.00
--	--------	----------

SNORKEL

Colorado 7 RG 2012+	ISNORKEL036	\$387.00
---------------------	-------------	----------

PREMIUM UNDERBODY PROTECTION

Engine Bay and Transmission	UBP041	\$712.00
-----------------------------	--------	----------

STEEL ROOF RACKS

Cage Style - 1.8 x 1.25m	IRRCAGE18	\$744.00
Rooftop Tent Compatible - 1.8 x 1.25m	IRRTENT18	\$709.00
Trade Style - 1.8m x 1.25m (Open end)	IRRTRADE18	\$709.00

ALLOY ROOF RACKS

Cage Style - 1.8m x 1.25m	IRRCAGE18-ALLOY	\$1049.00
Trade Style - 1.8m x 1.25m (Open end)	IRRTRADE18-ALLOY	\$1033.00
Flat Rack - 1.8m x 1.25m	IRRTFLAT18-ALLOY	\$1019.00

ROOF RACK - MOUNTING KITS

Mount Feet (6 Feet) - Suits OE rails	IRRFEET001	\$180.00
--------------------------------------	------------	----------

SEAT COVER

Canvas Comfort - Front	ICSC040F	\$400.00
Canvas Comfort - Rear	ICSC049R	\$400.00

DIFF BREATHER KIT

Diff Breather Kit	IDIFFBRE	\$114.00
-------------------	----------	----------



Trailblazer
2012+

Holden / GM Colorado 7

PRODUCT DESCRIPTION

PART NO.

QTY
RequiredRETAIL
ea Incl GST

SUSPENSION TO SUIT HOLDEN / GM COLORADO 7

FRONT SUSPENSION

SHOCK ABSORBER

Nitro Gas Strut - Performance			12745GR	2	\$209.09
Foam Cell Strut - Performance			24745FE	2	\$235.23
Foam Cell Pro Strut - Performance			45745FE	2	\$365.91

• Height adjustable with Ironman 4x4 Strut Trim Packers

COIL SPRINGS

	Est. Lift	Additional Load			
Standard	0mm	0 - 50kg	HOLD020S	1	\$235.23
Light	30mm	0 - 50kg	HOLD020A	1	\$235.23
Medium	40mm	0 - 50kg	HOLD020B	1	\$235.23
Heavy	40mm	50 - 110kg	HOLD020C	1	\$235.23

STRUT MOUNTS

Steel Strut Top			ISST017	2	\$78.41
-----------------	--	--	---------	---	---------

TRIM PACKERS

5mm Strut Trim Packer	Nitro Gas / Foam Cell	HILFR05 / HILFR05F	2	\$26.14
10mm Strut Trim Packer	Nitro Gas / Foam Cell	HILFR10 / HILFR10F	2	\$26.14
15mm Strut Trim Packer	Nitro Gas / Foam Cell	HILFR15 / HILFR15F	2	\$26.14

• ONLY Compatible with Ironman 4x4 Struts (except Pro), lift height subject to 2:1 motion ratio. Unnecessary fitment may lift vehicle too high

CONTROL ARMS

Pro-Forge Upper Control Arms			UCA041FA	1	\$831.60
------------------------------	--	--	----------	---	----------

REAR SUSPENSION

SHOCK ABSORBER

Nitro Gas - Comfort			12746GRC	2	\$143.75
Nitro Gas - Performance			12746GR	2	\$143.75
Foam Cell - Comfort			24746FEC	2	\$209.09
Foam Cell - Performance			24746FE	2	\$209.09
Foam Cell Pro - Comfort			45746FEC	2	\$287.50
Foam Cell Pro - Performance			45746FE	2	\$287.50

COIL SPRINGS

	Est. Lift	Additional Load			
Standard	0mm	0 - 250kg	HOLD022S	1	\$235.23
Light	30mm	0 - 250kg	HOLD022A	1	\$235.23
Medium	40mm	0 - 250kg	HOLD022B	1	\$235.23
Heavy	45mm	250kg - GVM	HOLD022C	1	\$235.23

SUSPENSION KIT

Standard - Nitro Gas			HOLD022SKG		\$1176.12
Standard - Foam Cell			HOLD022SKF		\$1359.08
Standard - Foam Cell Pro			HOLD022SKP		\$1777.25
Light - Nitro Gas			HOLD022AKG		\$1176.12
Light - Foam Cell			HOLD022AKF		\$1359.08
Light - Foam Cell Pro			HOLD022AKP		\$1777.25
Medium - Nitro Gas			HOLD022BKG		\$1176.12
Medium - Foam Cell			HOLD022BKF		\$1359.08
Medium - Foam Cell Pro			HOLD022BKP		\$1777.25
Heavy - Nitro Gas			HOLD022CKG		\$1176.12
Heavy - Foam Cell			HOLD022CKF		\$1359.08
Heavy - Foam Cell Pro			HOLD022CKP		\$1777.25

• Specify front Coil Springs when ordering

SUSPENSION KIT CONTENTS

Shock Absorbers

Strut Shock Absorbers

Coil Springs



PRODUCT DESCRIPTION

PART NO.

QTY
RequiredRETAIL
ea Incl GST

ACCESSORIES TO SUIT HOLDEN / GM COLORADO

STEEL WINCH BULL BARS

Commercial	BBC057	\$1598.00
Commercial Deluxe	BBCD057	\$2021.00
Protector	BBT057	
Proguard No Loop	BBT057-NL	\$1670.00
Proguard Single Loop Kit	BB057-SL	\$297.00
Proguard Triple Loop Kit	BB057-TL	\$357.00
Driving Light Patch Loom	IPL057	\$30.00

• Can also be fitted to both 2WD and 4WD models.

STEEL SIDE STEPS AND RAILS - FITS DUAL, SPACE AND SINGLE CAB MODELS ONLY

Side Steps	SS057	\$851.00
Side Rails	SS057 RAIL	\$280.00
Side Steps and Rails	SSR057	\$1022.00

TOWING

Class 4 Towbar - Compatible with Factory Rear Bumper	TB040	\$523.00
Rear Protection Towbar - Full Rear Bumper Replacement	RTB040	\$1196.00
Rear Protection Towbar Plates (Pair)	RTBPLATE002	\$131.00
Towbar Wiring Loom - Plug and Play	ITBL040	\$303.00
Load Resistor Kit with Mounting Brackets for Licence Plate Lights	LR12V10W	\$49.00

RECOVERY POINTS - IRONMAN 4X4 BULL BAR ONLY

Recovery Points (One piece, two points) - 5000kg rating	IRP057	\$350.00
Recovery Points - 5000kg Rating (Pair)	IRP058	\$286.00

LOCKSAFE DRAWER SYSTEMS

Twin Drawers - 1300mm	ITD1300	\$1469.00
Single Drawer - 1300mm	ISD1300	\$891.00
Wing Kit - 1300mm*	ITDW038	\$351.00

*Designed to suit factory tubs, will not suit ute liner without modification

BATTERY TRAY

Suits 8" Battery	IBTRAY057	\$149.00
------------------	-----------	----------

SNORKEL

Colorado RG 2016+	ISNORKEL036	\$387.00
-------------------	-------------	----------

LONG RANGE FUEL TANK

145L* Diesel only - Fits Dual Cab Automatic Transmission only	TANK057	\$1129.00
---	---------	-----------

* Usable volume may differ to the stated tank capacity

EXHAUST SYSTEM

3" Exhaust Upgrade 2.0L - DPF Back - While Stocks Last	IEX057	\$770.00
--	--------	----------

PREMIUM UNDERBODY PROTECTION

Engine Bay and Transmission	UBP057	\$712.00
-----------------------------	--------	----------

CANOPY - ABS PLASTIC (SIDE LIFT UP WINDOWS AND CENTRAL LOCKING REAR DOOR) - FITS 4X4 AND 4X2 DUAL CAB MODELS

Pre-Primed	CANOPY019-P	\$3143.00*
Summit White (GAZ)	CANOPY019-SW	\$3743.00
Black (GB0)	CANOPY019-MB	\$3743.00
Blue (G8P)	CANOPY019-PB	\$3743.00
Steel Grey (GYM)	CANOPY019-G	\$3743.00
Silver (GAN)	CANOPY019-NS	\$3743.00
Red (GG2)	CANOPY019-R	\$3743.00
ABS Canopy Rack Feet	IRRFETABS14	\$250.00

• See Page 33 and 34 for 1.4m Roof Rack options and pricing.

* Pre-primed canopies, plus colour coding.

SEAT COVER

Canvas Comfort - Front	ICSC040F	\$400.00
Canvas Comfort - Rear	ICSC040R	\$400.00

DIFF BREATHER KIT

Diff Breather Kit	IDIFFBRE	\$114.00
-------------------	----------	----------





RG
2016 to 2020

Holden / GM Colorado

PRODUCT DESCRIPTION

PART NO.

QTY Required

RETAIL ea Incl GST

SUSPENSION TO SUIT HOLDEN / GM COLORADO

FRONT SUSPENSION

SHOCK ABSORBER

Nitro Gas Strut - Performance			12745GR	2	\$209.09
Foam Cell Strut - Performance			24745FE	2	\$235.23
Foam Cell Pro Strut - Performance			45745FE	2	\$365.91

• Height adjustable with Ironman 4x4 Strut Trim Packers

COIL SPRINGS

	Est. Lift	Additional Load			
Medium	40mm	0 - 50kg	HOLD020A	1	\$235.23
Heavy	40mm	50 - 110kg	HOLD020B	1	\$235.23

STRUT MOUNTS

Steel Strut Top			ISST017	2	\$78.41
-----------------	--	--	----------------	---	---------

TRIM PACKERS

5mm Strut Trim Packer	Nitro Gas / Foam Cell	HILFR05 / HILFR05F	2	\$26.14
10mm Strut Trim Packer	Nitro Gas / Foam Cell	HILFR10 / HILFR10F	2	\$26.14
15mm Strut Trim Packer	Nitro Gas / Foam Cell	HILFR15 / HILFR15F	2	\$26.14

• ONLY Compatible with Ironman 4x4 Struts (except Pro), lift height subject to 2:1 motion ratio. Unnecessary fitment may lift vehicle too high

CONTROL ARMS

Pro-Forge Upper Control Arms			UCA041FA	1	\$831.60
------------------------------	--	--	-----------------	---	----------

REAR SUSPENSION

SHOCK ABSORBER

Nitro Gas - Comfort			12636GRC	2	\$143.75
Nitro Gas - Performance			12636GR	2	\$143.75
Nitro Gas - Professional			12636GRP	2	\$143.75
Foam Cell - Comfort			24636FEC	2	\$209.09
Foam Cell - Performance			24636FE	2	\$209.09
Foam Cell - Professional			24636FEP	2	\$209.09
Foam Cell Pro - Comfort			45636FEC	2	\$287.50
Foam Cell Pro - Performance			45636FE	2	\$287.50
Foam Cell Pro - Professional			45636FEP	2	\$287.50

LEAF SPRINGS

	Est. Lift	Additional Load			
Light	30mm	0 - 200kg	HOLD021A	2	\$378.98
Medium	45mm	0 - 300kg	HOLD021B	2	\$378.98
Heavy	45mm	300kg - 600kg	HOLD021C	2	\$392.04
Extra Heavy	45mm	600kg - GVM	HOLD021D	2	\$392.04

U-BOLTS

U-Bolt Kit			437UBKL	2	\$39.21
U-Bolt Kit	Suits HOLD021D		678UBK	2	\$39.21

POLYURETHANE SPRING BUSHES

Bush Kit			770UK	1	\$156.82
----------	--	--	--------------	---	----------

GREASABLE SHACKLES AND PINS

Greasable Shackle			1148	2	\$52.28
Non-Greasable Pin			387-1	2	\$26.14

HELPER SPRINGS

Add-A-Leaf			ISL6010	1	\$156.82
------------	--	--	----------------	---	----------

LISTING
CONTINUED
OVER THE
PAGE

Holden / GM Colorado

RG
2016 to 2020



PRODUCT DESCRIPTION

PART NO.

QTY
Required

RETAIL
ea Incl GST

SUSPENSION KIT

Light - Nitro Gas	HOLD021AKG1	\$1947.14
Light - Foam Cell	HOLD021AKF1	\$2130.09
Light - Foam Cell Pro	HOLD021AKP1	\$2548.26
Medium - Nitro Gas	HOLD021BKG1	\$1947.14
Medium - Foam Cell	HOLD021BKF1	\$2130.09
Medium - Foam Cell Pro	HOLD021BKP1	\$2548.26
Heavy - Nitro Gas	HOLD021CKG1	\$1973.27
Heavy - Foam Cell	HOLD021CKF1	\$2156.22
Heavy - Foam Cell Pro	HOLD021CKP1	\$2574.40
Extra Heavy - Nitro Gas	HOLD021DKG1	\$1973.27
Extra Heavy - Foam Cell	HOLD021DKF1	\$2156.22
Extra Heavy - Foam Cell Pro	HOLD021DKP1	\$2574.40

• Specify front Coil Springs when ordering

SUSPENSION KIT CONTENTS

Shock Absorbers	Coil Springs	Polyurethane Spring Bushes
Leaf Springs	U-Bolts	Strut Shock Absorbers



OPTIONS AVAILABLE FOR THIS VEHICLE - SEE PAGE 366





RG
2012 to 10/2016

Holden / GM Colorado

PRODUCT DESCRIPTION

PART NO.

QTY Required

RETAIL ea Incl GST

ACCESSORIES TO SUIT HOLDEN / GM COLORADO

STEEL WINCH BULL BARS

Commercial	BBC040	\$1569.00
Commercial Deluxe	BBCD040	\$1985.00
Driving Light Patch Loom	IPL057	\$30.00

• Can also be fitted to both 2WD and 4WD models.

STEEL SIDE STEPS AND RAILS

Side Steps	SS057	\$851.00
Side Rails	SS057 RAIL	\$280.00
Side Steps and Rails	SSR057	\$1022.00

TOWING

Class 4 Towbar - Compatible with Factory Rear Bumper	TB040	\$523.00
Rear Protection Towbar - Full Rear Bumper Replacement	RTB040	\$1196.00
Rear Protection Towbar Plates (Pair)	RTBPLATE002	\$131.00
Towbar Wiring Loom - Plug and Play	ITBL040	\$303.00

RECOVERY POINTS - IRONMAN 4X4 BULL BAR ONLY

Recovery Points - 5000kg Rating (Pair)	IRP058	\$286.00
--	--------	----------

LOCKSAFE DRAWER SYSTEMS

Twin Drawers - 1300mm	ITD1300	\$1469.00
Single Drawer - 1300mm	ISD1300	\$891.00
Wing Kit - 1300mm*	ITDW038	\$351.00

*Designed to suit factory tubs, will not suit ute liner without modification

SNORKEL

Colorado RG 2012-10/2016	ISNORKEL036	\$387.00
--------------------------	-------------	----------

LONG RANGE FUEL TANK

145L* Diesel only - Fits Dual Cab only	TANK057	\$1129.00
--	---------	-----------

* Usable volume may differ to the stated tank capacity

EXHAUST SYSTEM

BigBore 2.8L Turbo Diesel - While Stocks Last	IEXHAUST017	\$1300.00
---	-------------	-----------

PREMIUM UNDERBODY PROTECTION

Engine Bay and Transmission	UBP041	\$712.00
-----------------------------	--------	----------

CANOPY - ABS PLASTIC (SIDE LIFT UP WINDOWS AND CENTRAL LOCKING REAR DOOR) - FITS 4X4 AND 4X2 DUAL CAB MODELS

Pre-Primed	CANOPY019-P	\$3143.00*
Summit White (GAZ)	CANOPY019-SW †	\$3743.00
Oceanic Blue (774U)	CANOPY019-B	\$3743.00
Black Sapphire (2HU)	CANOPY019-BS	\$3743.00
Silver (636R)	CANOPY019-S	\$3743.00
ABS Canopy Rack Feet	IRRFETABS14	\$250.00

• See Page 33 and 34 for 1.4m Roof Rack options and pricing.

* Pre-primed canopies, plus colour coding. († With central locking)

SEAT COVER

Canvas Comfort - Front	ICSC040F	\$400.00
Canvas Comfort - Rear	ICSC040R	\$400.00

DIFF BREATHER KIT

Diff Breather Kit	IDIFFBRE	\$114.00
-------------------	----------	----------





PRODUCT DESCRIPTION

PART NO.

QTY
Required

RETAIL
ea Incl GST

SUSPENSION TO SUIT HOLDEN / GM COLORADO

FRONT SUSPENSION

SHOCK ABSORBER

Nitro Gas Strut - Performance			12745GR	2	\$209.09
Foam Cell Strut - Performance			24745FE	2	\$235.23
Foam Cell Pro Strut - Performance			45745FE	2	\$365.91

• Height adjustable with Ironman 4x4 Strut Trim Packers

COIL SPRINGS

	Est. Lift	Additional Load			
Standard	0mm	0 - 50kg	HOLD020S	1	\$235.23
Light	30mm	0 - 50kg	HOLD020A	1	\$235.23
Medium	40mm	0 - 50kg	HOLD020B	1	\$235.23
Heavy	40mm	50 - 110kg	HOLD020C	1	\$235.23

STRUT MOUNTS

Steel Strut Top			ISST017	2	\$78.41
-----------------	--	--	----------------	---	---------

TRIM PACKERS

5mm Strut Trim Packer	Nitro Gas / Foam Cell	HILFR05 / HILFR05F	2	\$26.14
10mm Strut Trim Packer	Nitro Gas / Foam Cell	HILFR10 / HILFR10F	2	\$26.14
15mm Strut Trim Packer	Nitro Gas / Foam Cell	HILFR15 / HILFR15F	2	\$26.14

• ONLY Compatible with Ironman 4x4 Struts (except Pro), lift height subject to 2:1 motion ratio. Unnecessary fitment may lift vehicle too high

CONTROL ARMS

Pro-Forge Upper Control Arms			UCA041FA	1	\$831.60
------------------------------	--	--	-----------------	---	----------

REAR SUSPENSION

SHOCK ABSORBER

Nitro Gas - Comfort			12636GRC	2	\$143.75
Nitro Gas - Performance			12636GR	2	\$143.75
Nitro Gas - Professional			12636GRP	2	\$143.75
Foam Cell - Comfort			24636FEC	2	\$209.09
Foam Cell - Performance			24636FE	2	\$209.09
Foam Cell - Professional			24636FEP	2	\$209.09
Foam Cell Pro - Comfort			45636FEC	2	\$287.50
Foam Cell Pro - Performance			45636FE	2	\$287.50
Foam Cell Pro - Professional			45636FEP	2	\$287.50

LEAF SPRINGS

	Est. Lift	Additional Load			
Light	30mm	0 - 200kg	HOLD021A	2	\$378.98
Medium	45mm	0 - 300kg	HOLD021B	2	\$378.98
Heavy	45mm	300kg - 600kg	HOLD021C	2	\$392.04
Extra Heavy	45mm	600kg - GVM	HOLD021D	2	\$392.04

U-BOLTS

U-Bolt Kit			437UBKL	2	\$39.21
U-Bolt Kit	Suits HOLD021D		678UBK	2	\$39.21

POLYURETHANE SPRING BUSHES

Bush Kit			770UK	1	\$156.82
----------	--	--	--------------	---	----------

GREASABLE SHACKLES AND PINS

Greasable Shackle			1148	2	\$52.28
Non-Greasable Pin			387-1	2	\$26.14

HELPER SPRINGS

Add-A-Leaf			ISL6010	1	\$156.82
------------	--	--	----------------	---	----------





RG
2012 to 2016

Holden / GM Colorado

PRODUCT DESCRIPTION

PART NO.

QTY
Required

RETAIL
ea Incl GST

SUSPENSION KIT

Light - Nitro Gas	HOLD021AKG	\$1947.14
Light - Foam Cell	HOLD021AKF	\$2130.09
Light - Foam Cell Pro	HOLD021AKP	\$2548.26
Medium - Nitro Gas	HOLD021BKG	\$1947.14
Medium - Foam Cell	HOLD021BKF	\$2130.09
Medium - Foam Cell Pro	HOLD021BKP	\$2548.26
Heavy - Nitro Gas	HOLD021CKG	\$1973.27
Heavy - Foam Cell	HOLD021CKF	\$2156.22
Heavy - Foam Cell Pro	HOLD021CKP	\$2574.40
Extra Heavy - Nitro Gas	HOLD021DKG	\$1973.27
Extra Heavy - Foam Cell	HOLD021DKF	\$2156.22
Extra Heavy - Foam Cell Pro	HOLD021DKP	\$2574.40

• Specify front Coil Springs when ordering

SUSPENSION KIT CONTENTS

Shock Absorbers	Coil Springs	Polyurethane Spring Bushes	Strut Shock Absorbers
Leaf Springs	U-Bolts	Brake Hose Relocation Kit	



OPTIONS AVAILABLE FOR THIS VEHICLE - SEE PAGE 366





PRODUCT DESCRIPTION

PART NO.

QTY
Required

RETAIL
ea Incl GST

SUSPENSION TO SUIT HOLDEN / GM COLORADO

FRONT SUSPENSION

SHOCK ABSORBER

Nitro Gas Strut - Performance **12797GR** 2 \$209.09

• Height adjustable with Ironman 4x4 Strut Trim Packers

COIL SPRINGS

	Est. Lift	Additional Load			
Medium	35mm	0 - 50kg	TOY038B	1	\$235.23
Heavy	35mm	50 - 110kg	TOY038C	1	\$235.23

TRIM PACKERS

5mm Strut Trim Packer	Nitro Gas / Foam Cell	HILFR05 / HILFR05F	2	\$26.14
10mm Strut Trim Packer	Nitro Gas / Foam Cell	HILFR10 / HILFR10F	2	\$26.14
15mm Strut Trim Packer	Nitro Gas / Foam Cell	HILFR15 / HILFR15F	2	\$26.14

• ONLY Compatible with Ironman 4x4 Struts (except Pro), lift height subject to 2:1 motion ratio. Unnecessary fitment may lift vehicle too high

REAR SUSPENSION

SHOCK ABSORBER

Nitro Gas - Comfort	12636GRC	2	\$143.75
Nitro Gas - Performance	12636GR	2	\$143.75
Nitro Gas - Professional	12636GRP	2	\$143.75
Foam Cell - Comfort	24636FEC	2	\$209.09
Foam Cell - Performance	24636FE	2	\$209.09
Foam Cell - Professional	24636FEP	2	\$209.09

LEAF SPRINGS

	Est. Lift	Additional Load			
Medium	45mm	0 - 300kg	HOLD023B	2	\$352.84
Heavy	45mm	300kg - 600kg	HOLD023C	2	\$378.98

U-BOLTS

U-Bolt Kit **417UBK** 2 \$39.21

POLYURETHANE SPRING BUSHES

Bush Kit **728UK** 1 \$78.41

GREASABLE SHACKLES AND PINS

Greasable Shackle **386-2** 2 \$52.28

HELPER SPRINGS

Add-A-Leaf **ISL6010** 1 \$156.82

SUSPENSION KIT

Medium - Nitro Gas	HOLD023BKG	\$1803.39
Heavy - Nitro Gas	HOLD023CKG	\$1855.66

• Specify front Coil Springs when ordering

SUSPENSION KIT CONTENTS

Shock Absorbers	Coil Springs	Polyurethane Spring Bushes
Leaf Springs	U-Bolts	Strut Shock Absorbers



RC
7/2008 to 12/2012

Holden / GM Colorado

PRODUCT DESCRIPTION

PART NO.

QTY
Required

RETAIL
ea Incl GST

ACCESSORIES TO SUIT HOLDEN / GM COLORADO

STEEL WINCH BULL BARS

Commercial Deluxe	BBCD027	\$1985.00
Protector - <i>While Stocks Last</i>	BBT027	\$2009.00

• Can also be fitted to both 2WD and 4WD models.

STEEL SIDE STEPS AND RAILS - FITS DUAL CAB MODELS ONLY

Side Steps	SS001	\$851.00
Side Steps and Rails	SSR006	\$1022.00

LOCKSAFE DRAWER SYSTEMS

Twin Drawers - 1300mm	ITD1300	\$1469.00
Single Drawer - 1300mm	ISD1300	\$891.00

SNORKEL

Colorado RC 7/2008 to 12/2012	ISNORKEL028	\$387.00
-------------------------------	-------------	----------

UNDERBODY PROTECTION

Engine Bay and Transmission	IUP009K	\$562.00
-----------------------------	---------	----------

CANOPY - ABS PLASTIC (SIDE LIFT UP WINDOWS) - FITS 4X4 AND 4X2 DUAL CAB MODELS

Pre-Primed	CANOPY006-P	\$3143.00*
------------	-------------	------------

* Pre-primed canopies, plus colour coding.

DIFF BREATHER KIT

Diff Breather Kit	IDIFFBRE	\$114.00
-------------------	----------	----------

LISTING
CONTINUED
OVER THE
PAGE



PRODUCT DESCRIPTION

PART NO.

QTY
Required

RETAIL
ea Incl GST

SUSPENSION TO SUIT HOLDEN / GM COLORADO

FRONT SUSPENSION

SHOCK ABSORBER

Nitro Gas - Performance	12667GR	2	\$143.75
Foam Cell - Performance	24667FE	2	\$209.09

TORSION BAR

Up-rated Torsion Bars	HOLD010	1	\$392.04
-----------------------	----------------	---	----------

• Minimum 60mm downward suspension travel required after adjustment

REAR SUSPENSION

SHOCK ABSORBER

Nitro Gas - Comfort	12636GRC	2	\$143.75
Nitro Gas - Performance	12636GR	2	\$143.75
Nitro Gas - Professional	12636GRP	2	\$143.75
Foam Cell - Comfort	24636FEC	2	\$209.09
Foam Cell - Performance	24636FE	2	\$209.09
Foam Cell - Professional	24636FEP	2	\$209.09

LEAF SPRINGS

	Est. Lift	Additional Load			
Medium	40mm	0 - 300kg	HOLD006B	2	\$352.84
Heavy	40mm	300kg - 600kg	HOLD006C	2	\$378.98
Extra Heavy	40mm	600 kg - GVM	HOLD006D	2	\$378.98

U-BOLTS

U-Bolt Kit	417UBK	2	\$39.21
------------	---------------	---	---------

POLYURETHANE SPRING BUSHES

Bush Kit	728TUK	1	\$78.41
----------	---------------	---	---------

GREASABLE SHACKLES AND PINS

Greasable Shackle	386-2	2	\$52.28
Non-Greasable Pin	387-1	2	\$26.14

HELPER SPRINGS

Add-A-Leaf	ISL6010	1	\$156.82
------------	----------------	---	----------

• Load Plus not suitable for Rodeo / Colorado / D-Max with OEM springs due to interleaf liners

SUSPENSION KIT

Medium - Nitro Gas	HOLD006BKG	\$1829.52
Medium - Foam Cell	HOLD006BKF	\$2090.88
Heavy - Nitro Gas	HOLD006CKG	\$1881.80
Heavy - Foam Cell	HOLD006CKF	\$2143.16
Extra Heavy - Nitro Gas	HOLD006DKG	\$1881.80
Extra Heavy - Foam Cell	HOLD006DKF	\$2143.16

SUSPENSION KIT CONTENTS

Shock Absorbers	Torsion Bars	Polyurethane Spring Bushes
Leaf Springs	U-Bolts	





RA7
2007 to 7/2008

Holden / GM Rodeo

PRODUCT DESCRIPTION

PART NO.

QTY
Required

RETAIL
ea Incl GST

ACCESSORIES TO SUIT HOLDEN / GM RODEO

STEEL WINCH BULL BARS

Commercial - <i>While Stocks Last</i>	BBC020	\$1569.00
Commercial Deluxe	BBCD020	\$1985.00
Protector - <i>While Stocks Last</i>	BBT020	\$2009.00

• Can also be fitted to both 2WD and 4WD models.

STEEL SIDE STEPS AND RAILS - FITS DUAL CAB MODELS ONLY

Side Steps	SS001	\$851.00
Side Steps and Rails	SSR006	\$1022.00

LOCKSAFE DRAWER SYSTEMS

Twin Drawers - 1300mm	ITD1300	\$1469.00
Single Drawer - 1300mm	ISD1300	\$891.00

SNORKEL

LX and LT (Does not fit DX model)	ISNORKEL022	\$387.00
-----------------------------------	-------------	----------

UNDERBODY PROTECTION

Engine Bay and Transmission	IUP009K	\$562.00
-----------------------------	---------	----------

CANOPY - ABS PLASTIC (SIDE LIFT UP WINDOWS) - FITS 4X4 AND 4X2 DUAL CAB MODELS

Pre-Primed	CANOPY006-P	\$3143.00*
------------	-------------	------------

* Pre-primed canopies, plus colour coding.

DIFF BREATHER KIT

Diff Breather Kit	IDIFFBRE	\$114.00
-------------------	----------	----------





PRODUCT DESCRIPTION

PART NO.

QTY
Required

RETAIL
ea Incl GST

SUSPENSION TO SUIT HOLDEN / GM RODEO

FRONT SUSPENSION

SHOCK ABSORBER

Nitro Gas - Performance	12667GR	2	\$143.75
Foam Cell - Performance	24667FE	2	\$209.09

TORSION BAR

Up-rated Torsion Bars	HOLD010	1	\$392.04
-----------------------	----------------	---	----------

• Minimum 60mm downward suspension travel required after adjustment

REAR SUSPENSION

SHOCK ABSORBER

Nitro Gas - Comfort	12636GRC	2	\$143.75
Nitro Gas - Performance	12636GR	2	\$143.75
Nitro Gas - Professional	12636GRP	2	\$143.75
Foam Cell - Comfort	24636FEC	2	\$209.09
Foam Cell - Performance	24636FE	2	\$209.09
Foam Cell - Professional	24636FEP	2	\$209.09

LEAF SPRINGS

	Est. Lift	Additional Load			
Medium	40mm	0 - 300kg	HOLD006B	2	\$352.84
Heavy	40mm	300kg - 600kg	HOLD006C	2	\$378.98
Extra Heavy	40mm	600 kg - GVM	HOLD006D	2	\$378.98

U-BOLTS

U-Bolt Kit	417UBK	2	\$39.21
------------	---------------	---	---------

POLYURETHANE SPRING BUSHES

Bush Kit	728TUK	1	\$78.41
----------	---------------	---	---------

GREASABLE SHACKLES AND PINS

Greasable Shackle	386-2	2	\$52.28
Non-Greasable Pin	387-1	2	\$26.14

HELPER SPRINGS

Add-A-Leaf	ISL6010	1	\$156.82
------------	----------------	---	----------

• Load Plus not suitable for Rodeo / Colorado / D-Max with OEM springs due to interleaf liners

SUSPENSION KIT

Medium - Nitro Gas	HOLD006BKG	\$1829.52
Medium - Foam Cell	HOLD006BKF	\$2090.88
Heavy - Nitro Gas	HOLD006CKG	\$1881.80
Heavy - Foam Cell	HOLD006CKF	\$2143.16
Extra Heavy - Nitro Gas	HOLD006DKG	\$1881.80
Extra Heavy - Foam Cell	HOLD006DKF	\$2143.16

SUSPENSION KIT CONTENTS

Shock Absorbers	Torsion Bars	Polyurethane Spring Bushes
Leaf Springs	U-Bolts	





RA
2002 to 2006

Holden / GM Rodeo

PRODUCT DESCRIPTION

PART NO.

QTY
Required

RETAIL
ea Incl GST

ACCESSORIES TO SUIT HOLDEN / GM RODEO

STEEL WINCH BULL BARS

Commercial Deluxe

BBCD003

\$1985.00

• Can also be fitted to both 2WD and 4WD models.

STEEL SIDE STEPS AND RAILS - FITS DUAL CAB MODELS ONLY

Side Steps

SS001

\$851.00

Side Steps and Rails

SSR006

\$1022.00

LOCKSAFE DRAWER SYSTEMS

Twin Drawers - 1300mm

ITD1300

\$1469.00

Single Drawer - 1300mm

ISD1300

\$891.00

UNDERBODY PROTECTION

Engine Bay and Transmission

IUP009K

\$562.00

CANOPY - ABS PLASTIC (SIDE LIFT UP WINDOWS) - FITS 4X4 AND 4X2 DUAL CAB MODELS

Pre-Primed

CANOPY006-P

\$3143.00*

* Pre-primed canopies, plus colour coding.

DIFF BREATHER KIT

Diff Breather Kit

IDIFFBRE

\$114.00



PRODUCT DESCRIPTION

PART NO.

QTY
Required

RETAIL
ea Incl GST

SUSPENSION TO SUIT HOLDEN / GM RODEO

FRONT SUSPENSION

SHOCK ABSORBER

Nitro Gas - Performance		12643GR	2	\$143.75
-------------------------	--	----------------	---	----------

TORSION BAR

Up-rated Torsion Bars		HOLD005A	1	\$392.04
-----------------------	--	-----------------	---	----------

• Minimum 60mm downward suspension travel required after adjustment

REAR SUSPENSION

SHOCK ABSORBER

Nitro Gas - Comfort		12636GRC	2	\$143.75
Nitro Gas - Performance		12636GR	2	\$143.75
Nitro Gas - Professional		12636GRP	2	\$143.75
Foam Cell - Comfort		24636FEC	2	\$209.09
Foam Cell - Performance		24636FE	2	\$209.09
Foam Cell - Professional		24636FEP	2	\$209.09

LEAF SPRINGS

	Est. Lift	Additional Load			
Medium - Drivers Side	40mm	0 - 300kg	HOLD004BD/S	1	\$352.84
Medium - Near Side	40mm	0 - 300kg	HOLD004BN/S	1	\$352.84
Heavy - Drivers Side	40mm	300kg - GVM	HOLD004CD/S	1	\$378.98
Heavy - Near Side	40mm	300kg - GVM	HOLD004CN/S	1	\$378.98

U-BOLTS

U-Bolt Kit		415UBK	2	\$39.21
------------	--	---------------	---	---------

POLYURETHANE SPRING BUSHES

Bush Kit		728UK	1	\$78.41
----------	--	--------------	---	---------

GREASABLE SHACKLES AND PINS

Greasable Shackle		386-2	2	\$52.28
Non-Greasable Pin		387-1	2	\$26.14

HELPER SPRINGS

Load Plus Helper Springs		LP3	1	\$156.82
Add-A-Leaf		ISL6010	1	\$156.82

SUSPENSION KIT

Medium - Nitro Gas	HOLD004BKG2	\$1829.52
Heavy - Nitro Gas	HOLD004CKG2	\$1881.80

SUSPENSION KIT CONTENTS

Shock Absorbers	Torsion Bars	Polyurethane Spring Bushes
Leaf Springs	U-Bolts	





KB - TF
1983 to 1988

Holden / GM Rodeo

PRODUCT DESCRIPTION

PART NO.

QTY
Required

RETAIL
ea Incl GST

SUSPENSION TO SUIT HOLDEN / GM RODEO

FRONT SUSPENSION

SHOCK ABSORBER

Nitro Gas - Performance		12087GR	2	\$143.75
Foam Cell - Performance		24087FE	2	\$209.09

TORSION BAR

Uprated Torsion Bars	Suits 1983 - 1988	MAZDA005	1	\$392.04
----------------------	-------------------	-----------------	---	----------

• Minimum 60mm downward suspension travel required after adjustment

REAR SUSPENSION

SHOCK ABSORBER

Nitro Gas - Comfort		12636GRC	2	\$143.75
Nitro Gas - Performance		12636GR	2	\$143.75
Nitro Gas - Professional		12636GRP	2	\$143.75
Foam Cell - Comfort		24636FEC	2	\$209.09
Foam Cell - Performance		24636FE	2	\$209.09
Foam Cell - Professional		24636FEP	2	\$209.09

LEAF SPRINGS

	Est. Lift	Additional Load			
Medium - Drivers Side	40mm	0 - 300kg	HOLD004BD/S	1	\$352.84
Medium - Near Side	40mm	0 - 300kg	HOLD004BN/S	1	\$352.84
Heavy - Drivers Side	40mm	300kg - GVM	HOLD004CD/S	1	\$378.98
Heavy - Near Side	40mm	300kg - GVM	HOLD004CN/S	1	\$378.98

U-BOLTS

U-Bolt Kit		451UBK	2	\$39.21
------------	--	---------------	---	---------

POLYURETHANE SPRING BUSHES

Bush Kit		728UK	1	\$78.41
----------	--	--------------	---	---------

GREASABLE SHACKLES AND PINS

Greasable Shackle		791	2	\$52.28
Greasable Pin		792	2	\$39.21

HELPER SPRINGS

Load Plus Helper Springs		LP3	1	\$156.82
Add-A-Leaf		ISL6010	1	\$156.82

SUSPENSION KIT

Medium - Nitro Gas		HOLD004BKG1		\$1829.52
Medium - Foam Cell		HOLD004BKF1		\$2090.88
Heavy - Nitro Gas		HOLD004CKG1		\$1881.80
Heavy - Foam Cell		HOLD004CKF1		\$2143.16

SUSPENSION KIT CONTENTS

Shock Absorbers	Torsion Bars	Polyurethane Spring Bushes
Leaf Springs	U-Bolts	

Hyundai iLoad

2016+



PRODUCT DESCRIPTION

PART NO.

QTY
Required

RETAIL
ea Incl GST

ACCESSORIES TO SUIT HYUNDAI ILOAD

SEAT COVER

Canvas Comfort - Front Bucket and 3/4 Bench (Suits TQ3-V Series II)

ICSCLOAD

\$400.00





2001+

Hyundai Terracan

PRODUCT DESCRIPTION

PART NO.

QTY
Required

RETAIL
ea Incl GST

SUSPENSION TO SUIT HYUNDAI TERRACAN

FRONT SUSPENSION

SHOCK ABSORBER

Nitro Gas - Performance		12087GR	2	\$143.75
Foam Cell - Performance		24087FE	2	\$209.09

TORSION BAR

Uprated Torsion Bars		HYUND004	1	\$444.32
----------------------	--	-----------------	---	----------

• Minimum 60mm downward suspension travel required after adjustment

REAR SUSPENSION

SHOCK ABSORBER

Nitro Gas - Comfort		12637GRC	2	\$143.75
Nitro Gas - Performance		12637GR	2	\$143.75

COIL SPRINGS

	Est. Lift	Additional Load		
Medium	40mm	0 - 300kg	HYUND003B	1

DIFF BREATHER EXTENDED

Breather Hose		DHOSE350	1	\$5.23
---------------	--	-----------------	---	--------

SUSPENSION KIT

Medium - Nitro Gas		HYUND003BKG		\$1259.76
--------------------	--	--------------------	--	-----------

SUSPENSION KIT CONTENTS

Shock Absorbers	Torsion Bar
Coil Springs	Extended Breather Hose





PRODUCT DESCRIPTION

DATE AVAILABLE

PART NO.

QTY
RequiredRETAIL
ea Incl GST

ACCESSORIES TO SUIT ISUZU D-MAX

STEEL WINCH BULL BARS

Commercial Deluxe		BBCD074	\$2021.00
Proguard No Loop	Q2 2021	BBT074-NL	\$1670.00
Proguard Single Loop Kit	Q2 2021	BB074-SL	\$297.00
Proguard Triple Loop Kit	Q2 2021	BB074-TL	\$357.00
Driving Light Patch Loom - Factory LED Headlight models only		IPL074	\$30.00
Load Resistor Kit with Mounting Brackets for Indicator / Parker Replacement		LR12V21W	\$49.00

• Winch with Steel Cable and Roller Fairlead is not suitable - Use Winch with Synthetic Rope and Alloy Hawse only

STEEL SIDE STEPS AND RAILS

Side Steps	Q2 2021	SS074	\$848.00
Side Rails	Q2 2021	SS074 RAIL	\$280.00
Side Steps and Rails	Q2 2021	SSR074	\$1022.00

TOWING

Rear Protection Towbar	Q2 2021	RTB074	\$1196.00
Towbar Wiring Loom - Plug and Play		ITBL041	\$139.00

RECOVERY POINTS - IRONMAN 4X4 BULL BAR ONLY

Recovery Points (Pair)		IRP074	\$200.00
------------------------	--	---------------	----------

LOCKSAFE DRAWER SYSTEMS

Twin Drawers - 1300mm		ITD1300	\$1469.00
Single Drawer - 1300mm		ISD1300	\$891.00
Wing Kit - 1300mm*	Q2 2021	ITDW074	\$352.00

*Designed to suit factory tubs, will not suit ute liner without modification

SNORKEL

D-Max 8/2019+	Q2 2021	ISNORKE074	\$387.00
---------------	----------------	-------------------	----------

PREMIUM UNDERBODY PROTECTION

Engine Bay and Transmission - Electric Steering Model	Q2 2021	UBP074S	\$712.00
Engine Bay and Transmission - Non-Electric Steering Model		UBP074	\$712.00

CANOPY - ABS PLASTIC (SIDE LIFT UP WINDOWS AND CENTRAL LOCKING REAR DOOR) - FITS 4X4 AND 4X2 DUAL CAB MODELS

Pre-Primed		CANOPY022-P	\$3143.00*
Colour Coded		CANOPY022-W	\$3743.00
ABS Canopy Rack Feet		IRRFEETABS14	\$250.00

• See Page 33 and 34 for 1.4m Roof Rack options and pricing.

* Pre-primed canopies, plus colour coding.

SEAT COVER

Canvas Comfort - Front	Q2 2021	ICSC074F	\$400.00
Canvas Comfort - Rear	Q2 2021	ICSC074R	\$400.00

DIFF BREATHER KIT

Diff Breather Kit		IDIFFBRE	\$114.00
-------------------	--	-----------------	----------



8/2019+

PRODUCT DESCRIPTION

DATE AVAILABLE

PART NO.

QTY
RequiredRETAIL
ea Incl GST

SUSPENSION TO SUIT ISUZU D-MAX

FRONT SUSPENSION

SHOCK ABSORBER

Nitro Gas Strut - Performance			12845GR	2	\$209.09
Foam Cell Strut - Performance			24845FE	2	\$235.23
Foam Cell Pro Strut - Performance			45845FE	2	\$365.91

• Height adjustable with Ironman 4x4 Strut Trim Packers

COIL SPRINGS

	Est. Lift	Additional Load			
Standard	0mm	0 - 50kg	HOLD020S	1	\$235.23
Light	30mm	0 - 50kg	HOLD020A	1	\$235.23
Medium	40mm	0 - 50kg	HOLD020B	1	\$235.23
Heavy	40mm	50 - 110kg	HOLD020C	1	\$235.23

STRUT MOUNTS

Steel Strut Top			ISST017	2	\$78.41
-----------------	--	--	---------	---	---------

TRIM PACKERS

5mm Strut Trim Packer	Nitro Gas / Foam Cell	HILFR05 / HILFR05F	2	\$26.14
10mm Strut Trim Packer	Nitro Gas / Foam Cell	HILFR10 / HILFR10F	2	\$26.14
15mm Strut Trim Packer	Nitro Gas / Foam Cell	HILFR15 / HILFR15F	2	\$26.14

• ONLY Compatible with Ironman 4x4 Struts (except Pro), lift height subject to 2:1 motion ratio. Unnecessary fitment may lift vehicle too high

CONTROL ARMS

Pro-Forge Upper Control Arms	Q2 2021	UCA074FA	1	\$831.60
------------------------------	---------	----------	---	----------

REAR SUSPENSION

SHOCK ABSORBER

Nitro Gas - Comfort			12698GRC	2	\$143.75
Nitro Gas - Performance			12698GR	2	\$143.75
Nitro Gas - Professional			12698GRP	2	\$143.75
Foam Cell - Comfort			24698FEC	2	\$209.09
Foam Cell - Performance			24698FE	2	\$209.09
Foam Cell - Professional			24698FEP	2	\$209.09
Foam Cell Pro - Comfort			45698FEC	2	\$287.50
Foam Cell Pro - Performance			45698FE	2	\$287.50
Foam Cell Pro - Professional			45698FEP	2	\$287.50

LEAF SPRINGS

	Est. Lift	Additional Load			
Light	30mm	0 - 200kg	HOLD021A	2	\$378.98
Medium	45mm	0 - 300kg	HOLD021B	2	\$378.98
Heavy	45mm	300kg - 600kg	HOLD021C	2	\$392.04
Extra Heavy	45mm	600kg - GVM	HOLD021D	2	\$392.04

U-BOLTS

U-Bolt Kit			437UBKL	2	\$39.21
U-Bolt Kit	Suits HOLD021D		678UBK	2	\$39.21

POLYURETHANE SPRING BUSHES

Bush Kit			770UK	1	\$156.82
----------	--	--	-------	---	----------

SPACER KIT

Brake Hose Relocation Kit			1152K	1	\$13.07
---------------------------	--	--	-------	---	---------

GREASABLE SHACKLES AND PINS

Greasable Shackle			1156	2	\$52.28
Non-Greasable Pin			387-1	2	\$26.14

HELPER SPRINGS

Add-A-Leaf			ISL6010	1	\$156.82
------------	--	--	---------	---	----------

LISTING
CONTINUED
OVER THE
PAGE

Isuzu D-Max

8/2019+



PRODUCT DESCRIPTION

PART NO.

QTY
Required

RETAIL
ea Incl GST

SUSPENSION KIT

Light - Nitro Gas	HOLD021AKG3	\$1947.14
Light - Foam Cell	HOLD021AKF3	\$2130.09
Light - Foam Cell Pro	HOLD021AKP3	\$2548.26
Medium - Nitro Gas	HOLD021BKG3	\$1947.14
Medium - Foam Cell	HOLD021BKF3	\$2130.09
Medium - Foam Cell Pro	HOLD021BKP3	\$2548.26
Heavy - Nitro Gas	HOLD021CKG3	\$1973.27
Heavy - Foam Cell	HOLD021CKF3	\$2156.22
Heavy - Foam Cell Pro	HOLD021CKP3	\$2574.40
Extra Heavy - Nitro Gas	HOLD021DKG3	\$1973.27
Extra Heavy - Foam Cell	HOLD021DKF3	\$2156.22
Extra Heavy - Foam Cell Pro	HOLD021DKP3	\$2574.40

• Specify front Coil Springs when ordering

SUSPENSION KIT CONTENTS

Shock Absorbers	Coil Springs	Polyurethane Spring Bushes	Brake Hose Relocation Kit
Strut Shock Absorbers	Leaf Springs	U-Bolts	



OPTIONS AVAILABLE FOR THIS VEHICLE - SEE PAGE 367



2/2017 to 7/2019

PRODUCT DESCRIPTION

PART NO.

QTY
RequiredRETAIL
ea Incl GST

ACCESSORIES TO SUIT ISUZU D-MAX

STEEL WINCH BULL BARS (WILL NOT FIT NARROW BODY)

Commercial	BBC058	\$1569.00
Commercial Deluxe	BBCD058	\$1985.00
Protector	BBT058	\$2009.00
Proguard No Loop	BBT058-NL	\$1641.00
Proguard Single Loop Kit	BB058-SL	\$297.00
Proguard Triple Loop Kit	BB058-TL	\$357.00
Driving Light Patch Loom - Factory LED Headlight models only	IPL058	\$30.00

• Can also be fitted to both 2WD and 4WD models.

STEEL SIDE STEPS AND RAILS - FITS DUAL, SPACE AND SINGLE CAB MODELS ONLY

Side Steps	SS057	\$851.00
Side Rails	SS057 RAIL	\$280.00
Side Steps and Rails	SSR057	\$1022.00

TOWING

Class 4 Towbar - Compatible with Factory Rear Bumper	TB041	\$523.00
Rear Protection Towbar - Full Rear Bumper Replacement	RTB041	\$1196.00
Rear Protection Towbar Plates (Pair)	RTBPLATE002	\$131.00
Towbar Wiring Loom - Plug and Play	ITBL041	\$139.00

RECOVERY POINTS - IRONMAN 4X4 BULL BAR ONLY

Recovery Points - 5000kg rating (Pair)	IRP058	\$286.00
--	--------	----------

LOCKSAFE DRAWER SYSTEMS

Twin Drawers - 1300mm	ITD1300	\$1469.00
Single Drawer - 1300mm	ISD1300	\$891.00
Wing Kit - 1300mm*	ITDW038	\$351.00

*Designed to suit factory tubs, will not suit ute liner without modification

SNORKEL

3.0L Turbo Diesel	ISNORKEL041	\$387.00
-------------------	-------------	----------

LONG RANGE FUEL TANK

145L* Diesel only - Fits Dual Cab Automatic Transmission only	TANK057	\$1129.00
---	---------	-----------

* Usable volume may differ to the stated tank capacity

EXHAUST SYSTEM

3" Exhaust Upgrade 3.0L - DPF Back - While Stocks Last	IEX058	\$770.00
--	--------	----------

PREMIUM UNDERBODY PROTECTION

Engine Bay and Transmission	UBP041	\$712.00
-----------------------------	--------	----------

CANOPY - ABS PLASTIC (SIDE LIFT UP WINDOWS AND CENTRAL LOCKING REAR DOOR) - FITS 4X4 AND 4X2 DUAL CAB MODELS

Pre-Primed	CANOPY020-P	\$3143.00*
Summit White (527)	CANOPY020-SW	\$3743.00
Blue (565)	CANOPY020-B	\$3743.00
Graphite (563)	CANOPY020-GG	\$3743.00
Cosmic Black (523)	CANOPY020-CB	\$3743.00
ABS Canopy Rack Feet	IRRFEETABS14	\$250.00

• See Page 33 and 34 for 1.4m Roof Rack options and pricing.

* Pre-primed canopies, plus colour coding.

SEAT COVER

Canvas Comfort - Front	ICSC040F	\$400.00
Canvas Comfort - Rear	ICSC040R	\$400.00

DIFF BREATHER KIT

Diff Breather Kit	IDIFFBRE	\$114.00
-------------------	----------	----------

LISTING
CONTINUED
OVER THE
PAGE



PRODUCT DESCRIPTION

PART NO.

QTY
RequiredRETAIL
ea Incl GST

SUSPENSION TO SUIT ISUZU D-MAX

FRONT SUSPENSION

SHOCK ABSORBER

Nitro Gas Strut - Performance			12745GR	2	\$209.09
Foam Cell Strut - Performance			24745FE	2	\$235.23
Foam Cell Pro Strut - Performance			45745FE	2	\$365.91

• Height adjustable with Ironman 4x4 Strut Trim Packers

COIL SPRINGS

	Est. Lift	Additional Load			
Medium	40mm	0 - 50kg	HOLD020A	1	\$235.23
Heavy	40mm	50 - 110kg	HOLD020B	1	\$235.23

STRUT MOUNTS

Steel Strut Top			ISST017	2	\$78.41
-----------------	--	--	----------------	---	---------

TRIM PACKERS

5mm Strut Trim Packer	Nitro Gas / Foam Cell	HILFR05 / HILFR05F	2	\$26.14
10mm Strut Trim Packer	Nitro Gas / Foam Cell	HILFR10 / HILFR10F	2	\$26.14
15mm Strut Trim Packer	Nitro Gas / Foam Cell	HILFR15 / HILFR15F	2	\$26.14

• ONLY Compatible with Ironman 4x4 Struts (except Pro), lift height subject to 2:1 motion ratio. Unnecessary fitment may lift vehicle too high

CONTROL ARMS

Pro-Forge Upper Control Arms			UCA041FAS	1	\$831.60
------------------------------	--	--	------------------	---	----------

REAR SUSPENSION

SHOCK ABSORBER

Nitro Gas - Comfort			12636GRC	2	\$143.75
Nitro Gas - Performance			12636GR	2	\$143.75
Nitro Gas - Professional			12636GRP	2	\$143.75
Foam Cell - Comfort			24636FEC	2	\$209.09
Foam Cell - Performance			24636FE	2	\$209.09
Foam Cell - Professional			24636FEP	2	\$209.09
Foam Cell Pro - Comfort			45636FEC	2	\$287.50
Foam Cell Pro - Performance			45636FE	2	\$287.50
Foam Cell Pro - Professional			45636FEP	2	\$287.50

LEAF SPRINGS

	Est. Lift	Additional Load			
Light	30mm	0 - 200kg	HOLD021A	2	\$378.98
Medium	45mm	0 - 300kg	HOLD021B	2	\$378.98
Heavy	45mm	300kg - 600kg	HOLD021C	2	\$392.04
Extra Heavy	45mm	600kg - GVM	HOLD021D	2	\$392.04

U-BOLTS

U-Bolt Kit			437UBKL	2	\$39.21
U-Bolt Kit		Suits HOLD021D	678UBK	2	\$39.21

POLYURETHANE SPRING BUSHES

Bush Kit			770UK	1	\$156.82
----------	--	--	--------------	---	----------

SPACER KIT

Brake Hose Relocation Kit			1152K	1	\$13.07
Tailshaft Spacer			ITSS021	1	\$78.41

GREASABLE SHACKLES AND PINS

Greasable Shackle			1148	2	\$52.28
Non-Greasable Pin			387-1	2	\$26.14

HELPER SPRINGS

Add-A-Leaf			ISL6010	1	\$156.82
------------	--	--	----------------	---	----------



2016 to 7/2019

SUSPENSION TO SUIT

Isuzu D-Max

PRODUCT DESCRIPTION

PART NO.

QTY
Required

RETAIL
ea Incl GST

SUSPENSION KIT

Light - Nitro Gas	HOLD021AKG1	\$1947.14
Light - Foam Cell	HOLD021AKF1	\$2130.09
Light - Foam Cell Pro	HOLD021AKP1	\$2548.26
Medium - Nitro Gas	HOLD021BKG1	\$1947.14
Medium - Foam Cell	HOLD021BKF1	\$2130.09
Medium - Foam Cell Pro	HOLD021BKP1	\$2548.26
Heavy - Nitro Gas	HOLD021CKG1	\$1973.27
Heavy - Foam Cell	HOLD021CKF1	\$2156.22
Heavy - Foam Cell Pro	HOLD021CKP1	\$2574.40
Extra Heavy - Nitro Gas	HOLD021DKG1	\$1973.27
Extra Heavy - Foam Cell	HOLD021DKF1	\$2156.22
Extra Heavy - Foam Cell Pro	HOLD021DKP1	\$2574.40

• Specify front Coil Springs when ordering

SUSPENSION KIT CONTENTS

Shock Absorbers	Coil Springs	U-Bolts	Brake Hose Relocation Kit
Strut Shock Absorbers	Leaf Springs	Polyurethane Spring Bushes	



OPTIONS AVAILABLE FOR THIS VEHICLE - SEE PAGE 368





PRODUCT DESCRIPTION

PART NO.

QTY
RequiredRETAIL
ea Incl GST

ACCESSORIES TO SUIT ISUZU D-MAX

STEEL WINCH BULL BARS - WILL NOT FIT NARROW BODY

Commercial	BBC041	\$1569.00
Commercial Deluxe	BBCD041	\$1985.00
Protector - <i>While Stocks Last</i>	BBT041	\$2009.00
Driving Light Patch Loom - Factory LED Headlight models only	IPL058	\$30.00

• Can also be fitted to both 2WD and 4WD models.

STEEL SIDE STEPS AND RAILS

Side Steps	SS057	\$851.00
Side Rails	SS057 RAIL	\$280.00
Side Steps and Rails	SSR057	\$1022.00

TOWING

Class 4 Towbar - Compatible with Factory Rear Bumper	TB041	\$523.00
Rear Protection Towbar - Full Rear Bumper Replacement	RTB041	\$1196.00
Rear Protection Towbar Plates (Pair)	RTBPLATE002	\$131.00
Towbar Wiring Loom - Plug and Play	ITBL041	\$139.00

RECOVERY POINTS - IRONMAN 4X4 BULL BAR ONLY

Recovery Points - 5000kg Rating (Pair)	IRP058	\$286.00
--	--------	----------

LOCKSAFE DRAWER SYSTEMS

Twin Drawers - 1300mm	ITD1300	\$1469.00
Single Drawer - 1300mm	ISD1300	\$891.00
Wing Kit - 1300mm*	ITDW038	\$351.00

*Designed to suit factory tubs, will not suit ute liner without modification.

SNORKEL

3.0L Turbo Diesel	ISNORKELO41	\$387.00
-------------------	-------------	----------

LONG RANGE FUEL TANK

145L* Diesel only - Fits Dual Cab only	TANK057	\$1129.00
--	---------	-----------

*Usable volume may differ to the stated tank capacity

EXHAUST SYSTEM

BigBore 3L Turbo Diesel - <i>While Stocks Last</i>	IEXHAUST016	\$1300.00
--	-------------	-----------

PREMIUM UNDERBODY PROTECTION

Engine Bay and Transmission	UBP041	\$712.00
-----------------------------	--------	----------

CANOPY ABS PLASTIC (SIDE LIFT UP WINDOWS) - FITS 4X4 AND 4X2 DUAL CAB MODELS

Pre-Primed	CANOPY020-P	\$3143.00*
Splash White (SW) (527)	CANOPY020-SW	\$3743.00
ABS Canopy Rack Feet	IRRFETABS14	\$250.00

• See Page 33 and 34 for 1.4m Roof Rack options and pricing.

*Pre-primed canopies, plus colour coding.

SEAT COVER

Canvas Comfort - Front	ICSC040F	\$400.00
Canvas Comfort - Rear	ICSC040R	\$400.00

DIFF BREATHER KIT

Diff Breather Kit	IDIFFBRE	\$114.00
-------------------	----------	----------





6/2012 to 1/2017

Isuzu D-Max

PRODUCT DESCRIPTION

PART NO.

QTY
Required

RETAIL
ea Incl GST

SUSPENSION TO SUIT ISUZU D-MAX

FRONT SUSPENSION

SHOCK ABSORBER

Nitro Gas Strut - Performance			12745GR	2	\$209.09
Foam Cell Strut - Performance			24745FE	2	\$235.23
Foam Cell Pro Strut - Performance			45745FE	2	\$365.91

• Height adjustable with Ironman 4x4 Strut Trim Packers

COIL SPRINGS

	Est. Lift	Additional Load			
Standard	0mm	0 - 50kg	HOLD020S	1	\$235.23
Light	30mm	0 - 50kg	HOLD020A	1	\$235.23
Medium	40mm	0 - 50kg	HOLD020B	1	\$235.23
Heavy	40mm	50 - 110kg	HOLD020C	1	\$235.23

STRUT MOUNTS

Steel Strut Top			ISST017	2	\$78.41
-----------------	--	--	----------------	---	---------

TRIM PACKERS

5mm Strut Trim Packer	Nitro Gas / Foam Cell	HILFR05 / HILFR05F	2	\$26.14
10mm Strut Trim Packer	Nitro Gas / Foam Cell	HILFR10 / HILFR10F	2	\$26.14
15mm Strut Trim Packer	Nitro Gas / Foam Cell	HILFR15 / HILFR15F	2	\$26.14

• ONLY Compatible with Ironman 4x4 Struts (except Pro), lift height subject to 2:1 motion ratio. Unnecessary fitment may lift vehicle too high

CONTROL ARMS

Pro-Forge Upper Control Arms			UCA041FAS	1	\$831.60
------------------------------	--	--	------------------	---	----------

REAR SUSPENSION

SHOCK ABSORBER

Nitro Gas - Comfort			12636GRC	2	\$143.75
Nitro Gas - Performance			12636GR	2	\$143.75
Nitro Gas - Professional			12636GRP	2	\$143.75
Foam Cell - Comfort			24636FEC	2	\$209.09
Foam Cell - Performance			24636FE	2	\$209.09
Foam Cell - Professional			24636FEP	2	\$209.09
Foam Cell Pro - Comfort			45636FEC	2	\$287.50
Foam Cell Pro - Performance			45636FE	2	\$287.50
Foam Cell Pro - Professional			45636FEP	2	\$287.50

LEAF SPRINGS

	Est. Lift	Additional Load			
Light	30mm	0 - 200kg	HOLD021A	2	\$378.98
Medium	45mm	0 - 300kg	HOLD021B	2	\$378.98
Heavy	45mm	300kg - 600kg	HOLD021C	2	\$392.04
Extra Heavy	45mm	600kg - GVM	HOLD021D	2	\$392.04

U-BOLTS

U-Bolt Kit			437UBKL	2	\$39.21
U-Bolt Kit	Suits HOLD021D		678UBK	2	\$39.21

POLYURETHANE SPRING BUSHES

Bush Kit			770UK	1	\$156.82
----------	--	--	--------------	---	----------

SPACER KIT

Brake Hose Relocation Kit			1152K	1	\$13.07
Tailshaft Spacer			ITSS021	1	\$78.41

GREASABLE SHACKLES AND PINS

Greasable Shackle			1148	2	\$52.28
Non-Greasable Pin			387-1	2	\$26.14

HELPER SPRINGS

Add-A-Leaf			ISL6010	1	\$156.82
------------	--	--	----------------	---	----------



Isuzu D-Max

6/2012 to 1/2017



PRODUCT DESCRIPTION

PART NO.

QTY
Required

RETAIL
ea Incl GST

SUSPENSION KIT

Light - Nitro Gas	HOLD021AKG	\$1947.14
Light - Foam Cell	HOLD021AKF	\$2130.09
Light - Foam Cell Pro	HOLD021AKP	\$2548.26
Medium - Nitro Gas	HOLD021BKG	\$1947.14
Medium - Foam Cell	HOLD021BKF	\$2130.09
Medium - Foam Cell Pro	HOLD021BKP	\$2548.26
Heavy - Nitro Gas	HOLD021CKG	\$1973.27
Heavy - Foam Cell	HOLD021CKF	\$2156.22
Heavy - Foam Cell Pro	HOLD021CKP	\$2574.40
Extra Heavy - Nitro Gas	HOLD021DKG	\$1973.27
Extra Heavy - Foam Cell	HOLD021DKF	\$2156.22
Extra Heavy - Foam Cell Pro	HOLD021DKP	\$2574.40

• Specify front Coil Springs when ordering

SUSPENSION KIT CONTENTS

Shock Absorbers	Coil Springs	U-Bolts	Brake Hose Relocation Kit
Strut Shock Absorbers	Leaf Springs	Polyurethane Spring Bushes	



OPTIONS AVAILABLE FOR THIS VEHICLE - SEE PAGE 368





Low Ride 2WD
2012+

PRODUCT DESCRIPTION

PART NO.

QTY
RequiredRETAIL
ea Incl GST

SUSPENSION TO SUIT ISUZU D-MAX

FRONT SUSPENSION

SHOCK ABSORBER

Nitro Gas Strut - Performance **12797GR** 2 \$209.09

• Height adjustable with Ironman 4x4 Strut Trim Packers

COIL SPRINGS

	Est. Lift	Additional Load			
Medium	35mm	0 - 50kg	TOY038B	1	\$235.23
Heavy	35mm	50 - 110kg	TOY038C	1	\$235.23

TRIM PACKERS

5mm Strut Trim Packer	Nitro Gas / Foam Cell	HILFR05 / HILFR05F	2	\$26.14
10mm Strut Trim Packer	Nitro Gas / Foam Cell	HILFR10 / HILFR10F	2	\$26.14
15mm Strut Trim Packer	Nitro Gas / Foam Cell	HILFR15 / HILFR15F	2	\$26.14

• ONLY Compatible with Ironman 4x4 Struts (except Pro), lift height subject to 2:1 motion ratio. Unnecessary fitment may lift vehicle too high

REAR SUSPENSION

SHOCK ABSORBER

Nitro Gas - Comfort	12636GRC	2	\$143.75
Nitro Gas - Performance	12636GR	2	\$143.75
Nitro Gas - Professional	12636GRP	2	\$143.75
Foam Cell - Comfort	24636FEC	2	\$209.09
Foam Cell - Performance	24636FE	2	\$209.09
Foam Cell - Professional	24636FEP	2	\$209.09

LEAF SPRINGS

	Est. Lift	Additional Load			
Medium	45mm	0 - 300kg	HOLD023B	2	\$352.84
Heavy	45mm	300kg - 600kg	HOLD023C	2	\$378.98

U-BOLTS

U-Bolt Kit **417UBK** 2 \$39.21

POLYURETHANE SPRING BUSHES

Bush Kit **728UK** 1 \$78.41

GREASABLE SHACKLES AND PINS

Greasable Shackle **386-2** 2 \$52.28

HELPER SPRINGS

Add-A-Leaf **ISL6010** 1 \$156.82

SUSPENSION KIT

Medium - Nitro Gas	HOLD023BKG	\$1803.39
Heavy - Nitro Gas	HOLD023CKG	\$1855.66

• Specify front Coil Springs when ordering

SUSPENSION KIT CONTENTS

Shock Absorbers	Coil Springs	Polyurethane Spring Bushes
Leaf Springs	U-Bolts	Strut Shock Absorbers



PRODUCT DESCRIPTION

PART NO.

QTY
Required

RETAIL
ea Incl GST

ACCESSORIES TO SUIT ISUZU D-MAX

STEEL WINCH BULL BARS

Commercial - <i>While Stocks Last</i>	BBC020	\$1569.00
Commercial Deluxe	BBCD020	\$1985.00
Protector - <i>While Stocks Last</i>	BBT020	\$2009.00

• Can also be fitted to both 2WD and 4WD models.

STEEL SIDE STEPS AND RAILS - FITS DUAL CAB MODELS ONLY

Side Steps	SS001	\$851.00
Side Steps and Rails	SSR006	\$1022.00

LOCKSAFE DRAWER SYSTEMS

Twin Drawers - 1300mm	ITD1300	\$1469.00
Single Drawer - 1300mm	ISD1300	\$891.00

SNORKEL

D-MAX 2009+ (Does not fit 4x2 SX model)	ISNORKEL022	\$387.00
---	-------------	----------

UNDERBODY PROTECTION

Engine Bay and Transmission	IUP009K	\$562.00
-----------------------------	---------	----------

CANOPY ABS PLASTIC (SIDE LIFT UP WINDOWS) - FITS 4X4 AND 4X2 DUAL CAB MODELS

Pre-Primed	CANOPY006-P	\$3143.00*
------------	-------------	------------

* Pre-primed canopies, plus colour coding.

DIFF BREATHER KIT

Diff Breather Kit	IDIFFBRE	\$114.00
-------------------	----------	----------



Isuzu D-Max

2003 to 2012

PRODUCT DESCRIPTION

PART NO.

QTY
RequiredRETAIL
ea Incl GST

SUSPENSION TO SUIT ISUZU D-MAX

FRONT SUSPENSION

SHOCK ABSORBER

Nitro Gas - Performance	12667GR	2	\$143.75
Foam Cell - Performance	24667FE	2	\$209.09

TORSION BAR

Uprated Torsion Bars	HOLD010	1	\$392.04
----------------------	---------	---	----------

• Minimum 60mm downward suspension travel required after adjustment

REAR SUSPENSION

SHOCK ABSORBER

Nitro Gas - Comfort	12636GRC	2	\$143.75
Nitro Gas - Performance	12636GR	2	\$143.75
Nitro Gas - Professional	12636GRP	2	\$143.75
Foam Cell - Comfort	24636FEC	2	\$209.09
Foam Cell - Performance	24636FE	2	\$209.09
Foam Cell - Professional	24636FEP	2	\$209.09

LEAF SPRINGS

	Est. Lift	Additional Load			
Medium	40mm	0 - 300kg	HOLD006B	2	\$352.84
Heavy	40mm	300kg - 600kg	HOLD006C	2	\$378.98
Extra Heavy	40mm	600 kg - GVM	HOLD006D	2	\$378.98

U-BOLTS

U-Bolt Kit	417UBK	2	\$39.21
------------	--------	---	---------

POLYURETHANE SPRING BUSHES

Bush Kit	728TUK	1	\$78.41
----------	--------	---	---------

GREASABLE SHACKLES AND PINS

Greasable Shackle	386-2	2	\$52.28
Non-Greasable Pin	387-1	2	\$26.14

HELPER SPRINGS

Add-A-Leaf	ISL6010	1	\$156.82
------------	---------	---	----------

• Load Plus not suitable for Rodeo / Colorado / D-Max with OEM springs due to interleaf liners

SUSPENSION KIT

Medium - Nitro Gas	HOLD006BKG	\$1829.52
Medium - Foam Cell	HOLD006BKF	\$2090.88
Heavy - Nitro Gas	HOLD006CKG	\$1881.80
Heavy - Foam Cell	HOLD006CKF	\$2143.16
Extra Heavy - Nitro Gas	HOLD006DKG	\$1881.80
Extra Heavy - Foam Cell	HOLD006DKF	\$2143.16

SUSPENSION KIT CONTENTS

Shock Absorbers	Torsion Bars	Polyurethane Spring Bushes
Leaf Springs	U-Bolts	



PRODUCT DESCRIPTION

PART NO.

QTY
RequiredRETAIL
ea Incl GST

ACCESSORIES TO SUIT ISUZU MU-X

STEEL WINCH BULL BARS

Commercial Deluxe - (2014 to 2/2017)	BBCD049	\$1985.00
Commercial Deluxe - (3/2017+)	BBCD061	\$1985.00
Protector - (2014 to 2/2017) - <i>While Stocks Last</i>	BBT049	\$1765.00
Proguard No Loop - (3/2017+)	BBT061-NL	\$1641.00
Proguard Single Loop Kit	BB061-SL	\$297.00
Proguard Triple Loop Kit - (3/2017+)	BB061-TL	\$357.00
Driving Light Patch Loom - Factory LED Headlight models only	IPL058	\$30.00

STEEL SIDE STEPS AND RAILS

Side Steps	SS044	\$851.00
Side Rails	SS044 RAIL	\$280.00
Side Steps and Rails	SSR044	\$1022.00

RECOVERY POINTS - IRONMAN 4X4 BULL BAR ONLY

Recovery Points - 5000kg Rating (Pair)	IRP058	\$286.00
--	--------	----------

SNORKEL

3.0L Turbo Diesel	ISNORKELO41	\$387.00
-------------------	-------------	----------

PREMIUM UNDERBODY PROTECTION

Engine Bay and Transmission	UBP041	\$712.00
-----------------------------	--------	----------

STEEL ROOF RACKS

Cage Style - 1.8m x 1.25m	IRRCAGE18	\$744.00
Rooftop Tent Compatible - 1.8m x 1.25m	IRRTENT18	\$709.00
Trade Style - 1.8m x 1.25m (Open end)	IRRTRADE18	\$709.00

ALLOY ROOF RACKS

Cage Style - 1.8m x 1.25m	IRRCAGE18-ALLOY	\$1049.00
Trade Style - 1.8m x 1.25m (Open end)	IRRTRADE18-ALLOY	\$1033.00
Flat Rack - 1.8m x 1.25m	IRRTFLAT18-ALLOY	\$1019.00

ROOF RACK - MOUNTING KITS

MU-X Mount to suit LS-T model only	IRRFEETMUX	\$199.00
------------------------------------	------------	----------

• Will only fit vehicles with factory fitted roof bars.

SEAT COVER

Canvas Comfort - Front	ICSC040F	\$400.00
Canvas Comfort - Rear	ICSC049R	\$400.00

DIFF BREATHER KIT

Diff Breather Kit	IDIFFBRE	\$114.00
-------------------	----------	----------



2013+

PRODUCT DESCRIPTION

PART NO.

QTY
RequiredRETAIL
ea Incl GST

SUSPENSION TO SUIT ISUZU MU-X

FRONT SUSPENSION

SHOCK ABSORBER

Nitro Gas Strut - Performance			12745GR	2	\$209.09
Foam Cell Strut - Performance			24745FE	2	\$235.23
Foam Cell Pro Strut - Performance			45745FE	2	\$365.91

• Height adjustable with Ironman 4x4 Strut Trim Packers

COIL SPRINGS

	Est. Lift	Additional Load			
Standard	0mm	0 - 50kg	HOLD020S	1	\$235.23
Light	30mm	0 - 50kg	HOLD020A	1	\$235.23
Medium	40mm	0 - 50kg	HOLD020B	1	\$235.23
Heavy	40mm	50 - 110kg	HOLD020C	1	\$235.23

STRUT MOUNTS

Steel Strut Top			ISST017	2	\$78.41
-----------------	--	--	----------------	---	---------

TRIM PACKERS

5mm Strut Trim Packer	Nitro Gas / Foam Cell	HILFR05 / HILFR05F	2	\$26.14
10mm Strut Trim Packer	Nitro Gas / Foam Cell	HILFR10 / HILFR10F	2	\$26.14
15mm Strut Trim Packer	Nitro Gas / Foam Cell	HILFR15 / HILFR15F	2	\$26.14

• ONLY Compatible with Ironman 4x4 Struts (except Pro), lift height subject to 2:1 motion ratio. Unnecessary fitment may lift vehicle too high

CONTROL ARMS

Pro-Forge Upper Control Arms			UCA041FAS	1	\$831.60
------------------------------	--	--	------------------	---	----------

REAR SUSPENSION

SHOCK ABSORBER

Nitro Gas - Comfort			12746GRC	2	\$143.75
Nitro Gas - Performance			12746GR	2	\$143.75
Foam Cell - Comfort			24746FEC	2	\$209.09
Foam Cell - Performance			24746FE	2	\$209.09
Foam Cell Pro - Comfort			45746FEC	2	\$287.50
Foam Cell Pro - Performance			45746FE	2	\$287.50

COIL SPRINGS

	Est. Lift	Additional Load			
Medium	40mm	0 - 250kg	HOLD008B	1	\$235.23
Heavy	40mm	250kg - GVM	HOLD008C	1	\$235.23

SUSPENSION KIT

Medium - Nitro Gas	HOLD020BKG	\$1176.12
Medium - Foam Cell	HOLD020BKF	\$1359.08
Medium - Foam Cell Pro	HOLD020BKP	\$1777.25
Heavy - Nitro Gas	HOLD020CKG	\$1176.12
Heavy - Foam Cell	HOLD020CKF	\$1359.08
Heavy - Foam Cell Pro	HOLD020CKP	\$1777.25

• Specify front Coil Springs when ordering

SUSPENSION KIT CONTENTS

Shock Absorbers

Coil Springs

Torsion Bars

Isuzu Trooper

1992+



PRODUCT DESCRIPTION

PART NO.

QTY
Required

RETAIL
ea Incl GST

SUSPENSION TO SUIT ISUZU TROOPER

FRONT SUSPENSION

SHOCK ABSORBER

Nitro Gas - Performance	12643GR	2	\$143.75
Foam Cell - Performance	24643FE	2	\$209.09

TORSION BAR

Up-rated Torsion Bars	HOLD009	1	\$392.04
-----------------------	----------------	---	----------

• Minimum 60mm downward suspension travel required after adjustment

REAR SUSPENSION

SHOCK ABSORBER

Nitro Gas - Performance	12644GR	2	\$143.75
Foam Cell - Performance	24644FE	2	\$209.09

COIL SPRINGS

	Est. Lift	Additional Load			
Medium	40mm	0 - 300kg	HOLD008B	1	\$235.23
Heavy	40mm	300kg - GVM	HOLD008C	1	\$235.23

• Use HOLD008C for 3/2001+ Models

SUSPENSION KIT

Medium - Nitro Gas	HOLD008BKG	\$1202.26
Medium - Foam Cell	HOLD008BKF	\$1463.62
Heavy - Nitro Gas	HOLD008CKG	\$1202.26
Heavy - Foam Cell	HOLD008CKF	\$1463.62

SUSPENSION KIT CONTENTS

Shock Absorbers Leaf Springs Torsion Bars





11/1986 to 1991

Isuzu Trooper

PRODUCT DESCRIPTION

PART NO.

QTY
RequiredRETAIL
ea Incl GST

SUSPENSION TO SUIT ISUZU TROOPER

FRONT SUSPENSION

SHOCK ABSORBER

Nitro Gas - Performance		12087GR	2	\$143.75
Foam Cell - Performance		24087FE	2	\$209.09

TORSION BAR

Uprated Torsion Bars	33mm Spline	HOLD005A	1	\$392.04
Uprated Torsion Bars	33mm Spline	HOLD007	1	\$653.40

• Minimum 60mm downward suspension travel required after adjustment

REAR SUSPENSION

SHOCK ABSORBER

Nitro Gas - Performance		12671GR	2	\$143.75
-------------------------	--	----------------	---	----------

LEAF SPRINGS

	Est. Lift	Additional Load			
Medium - Drivers Side	40mm	0 - 300kg	HOLD004BD/S	1	\$352.84
Medium - Near Side	40mm	0 - 300kg	HOLD004BN/S	1	\$352.84
Heavy - Drivers Side	40mm	300kg - GVM	HOLD004CD/S	1	\$378.98
Heavy - Near Side	40mm	300kg - GVM	HOLD004CN/S	1	\$378.98

U-BOLTS

U-Bolt Kit		451UBK	2	\$39.21
------------	--	---------------	---	---------

POLYURETHANE SPRING BUSHES

Bush Kit		747UK	1	\$78.41
----------	--	--------------	---	---------

GREASABLE SHACKLES AND PINS

Greasable Shackle		791	2	\$52.28
Greasable Pin		792	2	\$39.21

HELPER SPRINGS

Load Plus Helper Springs		LP3	1	\$156.82
Add-A-Leaf		ISL6010	1	\$156.82

SUSPENSION KIT

Medium - Nitro Gas		HOLD007BKG		\$2090.88
Medium - Foam Cell		HOLD007BKF		\$2221.56
Heavy - Nitro Gas		HOLD007CKG		\$1761.57
Heavy - Foam Cell		HOLD007CKF		\$2273.84

SUSPENSION KIT CONTENTS

Shock Absorbers	Torsion Bars	Polyurethane Spring Bushes
Leaf Springs	U-Bolts	



PRODUCT DESCRIPTION

PART NO.

QTY
Required

RETAIL
ea Incl GST

SUSPENSION TO SUIT ISUZU TROOPER

FRONT SUSPENSION

SHOCK ABSORBER

Nitro Gas - Performance		12087GR	2	\$143.75
Foam Cell - Performance		24087FE	2	\$209.09

TORSION BAR

Uprated Torsion Bars		MAZDA005	1	\$392.04
----------------------	--	-----------------	---	----------

• Minimum 60mm downward suspension travel required after adjustment

REAR SUSPENSION

SHOCK ABSORBER

Nitro Gas - Comfort		12636GRC	2	\$143.75
Nitro Gas - Performance		12636GR	2	\$143.75
Foam Cell - Comfort		24636FEC	2	\$209.09
Foam Cell - Performance		24636FE	2	\$209.09

LEAF SPRINGS

	Est. Lift	Additional Load		
Medium - Drivers Side	40mm	0 - 300kg	HOLD004BD/S	\$352.84
Medium - Near Side	40mm	0 - 300kg	HOLD004BN/S	\$352.84
Heavy - Drivers Side	40mm	300kg - GVM	HOLD004CD/S	\$378.98
Heavy - Near Side	40mm	300kg - GVM	HOLD004CN/S	\$378.98

U-BOLTS

U-Bolt Kit		451UBK	2	\$39.21
------------	--	---------------	---	---------

POLYURETHANE SPRING BUSHES

Bush Kit		747UK	1	\$78.41
----------	--	--------------	---	---------

GREASABLE SHACKLES AND PINS

Greasable Shackle		791	2	\$52.28
Greasable Pin		792	2	\$39.21

HELPER SPRINGS

Load Plus Helper Springs		LP3	1	\$156.82
Add-A-Leaf		ISL6010	1	\$156.82

SUSPENSION KIT

Medium - Nitro Gas		HOLD005BKG		\$1829.52
Medium - Foam Cell		HOLD005BKF		\$2090.88
Heavy - Nitro Gas		HOLD005CKG		\$1881.80
Heavy - Foam Cell		HOLD005CKF		\$2143.16

SUSPENSION KIT CONTENTS

Shock Absorbers	Torsion Bars	Polyurethane Spring Bushes
Leaf Springs	U-Bolts	





Liberty KK
2007 to 2012

Jeep Cherokee

PRODUCT DESCRIPTION

PART NO.

QTY
Required

RETAIL
ea Incl GST

SUSPENSION TO SUIT JEEP CHEROKEE

FRONT SUSPENSION

SHOCK ABSORBER

Nitro Gas - Performance		12711GR	2	\$209.09
-------------------------	--	----------------	---	----------

• Height adjustable with Ironman 4x4 Strut Trim Packers

TRIM PACKERS

5mm Strut Trim Packer	Nitro Gas	HILFR05	2	\$26.14
10mm Strut Trim Packer	Nitro Gas	HILFR10	2	\$26.14
15mm Strut Trim Packer	Nitro Gas	HILFR15	2	\$26.14

• ONLY Compatible with Ironman 4x4 Struts, lift height subject to 2:1 motion ratio. Unnecessary fitment may lift vehicle too high

REAR SUSPENSION

SHOCK ABSORBER

Nitro Gas - Performance		12712GR	2	\$143.75
-------------------------	--	----------------	---	----------

• Vehicles with monocoque body construction can be subject to increased NVH (Noise) with upgraded suspension installed





PRODUCT DESCRIPTION

PART NO.

QTY
Required

RETAIL
ea Incl GST

SUSPENSION TO SUIT JEEP CHEROKEE

FRONT SUSPENSION

SHOCK ABSORBER

Nitro Gas Strut - Performance			12711GR	2	\$209.09
-------------------------------	--	--	----------------	---	----------

• Height adjustable with Ironman 4x4 Strut Trim Packers

COIL SPRINGS

	Est. Lift	Additional Load			
Medium	40mm	0 - 50kg	JEEP014B	1	\$235.23
Heavy or Diesel	40mm	50 - 100kg	JEEP014C	1	\$235.23

TRIM PACKERS

5mm Strut Trim Packer	Nitro Gas	HILFR05	2	\$26.14
10mm Strut Trim Packer	Nitro Gas	HILFR10	2	\$26.14
15mm Strut Trim Packer	Nitro Gas	HILFR15	2	\$26.14

• ONLY Compatible with Ironman 4x4 Struts, lift height subject to 2:1 motion ratio. Unnecessary fitment may lift vehicle too high

REAR SUSPENSION

SHOCK ABSORBER

Nitro Gas - Performance			12712GR	2	\$143.75
-------------------------	--	--	----------------	---	----------

COIL SPRINGS

	Est. Lift	Additional Load			
Medium	40mm	0 - 200kg	JEEP015B	1	\$235.23

SUSPENSION KIT

Medium - Nitro Gas	JEEP014BKG	\$1176.12
Medium - Nitro Gas (Diesel)	JEEP014BKG1	\$1176.12

• Vehicles with monocoque body construction can be subject to increased NVH (Noise) with upgraded suspension installed

• Specify front Coil Springs when ordering

SUSPENSION KIT CONTENTS

Shock Absorbers

Coil Springs

Jeep Cherokee

XJ
1984+

PRODUCT DESCRIPTION

PART NO.

QTY
RequiredRETAIL
ea Incl GST

SUSPENSION TO SUIT JEEP CHEROKEE

FRONT SUSPENSION

SHOCK ABSORBER

Nitro Gas - Performance			12665GR	2	\$143.75
Foam Cell - Performance			24665FE	2	\$209.09

COIL SPRINGS

	Est. Lift	Additional Load			
Medium	45mm	0 - 100kg	JEEP016B	1	\$235.23

STEERING DAMPER

Foam Cell			3540	1	\$156.82
-----------	--	--	-------------	---	----------

REAR SUSPENSION

SHOCK ABSORBER

Nitro Gas - Performance			12666GR	2	\$143.75
Foam Cell - Performance			24666FE	2	\$209.09

LEAF SPRINGS

	Est. Lift	Additional Load			
Medium - Drivers Side	45mm	0 - 250kg	JEEP004BD/S	1	\$378.98
Medium - Near Side	45mm	0 - 250kg	JEEP004BN/S	1	\$378.98

• In some cases a driveline vibration may occur after lift, a gearbox crossmember spacer may be required

U-BOLTS

U-Bolt Kit			512UBK	2	\$39.21
------------	--	--	---------------	---	---------

POLYURETHANE SPRING BUSHES

Bush Kit			762UK	1	\$156.82
----------	--	--	--------------	---	----------

SUSPENSION KIT

Medium - Nitro Gas			JEEP003BKG		\$1803.39
Medium - Foam Cell			JEEP003BKF		\$2064.75

• In some cases a driveline vibration may occur after lift, a gearbox crossmember spacer may be required

SUSPENSION KIT CONTENTS

Shock Absorbers	Coil Springs	Polyurethane Spring Bushes
Leaf Springs	U-Bolts	



PRODUCT DESCRIPTION

DATE AVAILABLE

PART NO.

QTY
RequiredRETAIL
ea Incl GST

ACCESSORIES TO SUIT JEEP GLADIATOR

STEEL WINCH BULL BARS

Raid Full Length Steel Bumper*	Q2 2021	BBR077		\$1260.00
Raid Stubby Bumper*	Q2 2021	BBR077ST		\$1120.00
Driving Light Patch Loom		IPL077		\$34.00

* Compatible with Ironman 4x4 Cube Lights and Lightbars, refer below for available options

LIGHTING OPTIONS - TO SUIT RAID BULL BARS

105W Bright Sabre-X Single Row Slim Lightbar 522mm (20") Straight	Q2 2021	ILBSR003B	1	\$210.00
40W Bright Cube Spot Beam LED Cube Light - 81 x 75mm (Each) - Clear	Q2 2021	ILED80B	2	\$79.00
40W Bright Cube Spot Beam LED Cube Light - 81 x 75mm (Each) - Amber	Q2 2021	ILED80BA	2	\$79.00
40W Bright Cube Flood Beam LED Cube Light - 81 x 75mm (Each) - Clear	Q2 2021	ILED80BF	2	\$79.00
40W Bright Cube Flood Beam LED Cube Light - 81 x 75mm (Each) - Amber	Q2 2021	ILED80BFA	2	\$79.00

STEEL SIDE STEPS

Raid Rock Sliders	Q2 2021	SS077JT		\$848.00
-------------------	---------	---------	--	----------

REAR PROTECTION

Raid Steel Rear Bumper*	Q2 2021	RTB077JT		\$950.00
-------------------------	---------	----------	--	----------

* Compatible with Ironman 4x4 Cube Lights, refer below for available options

LIGHTING OPTIONS - TO SUIT RAID REAR BARS

20W Bright Cube Spot Beam LED Cube Light - 70 x 64mm (Each) - Clear	Q2 2021	ILED20B	2	\$59.00
20W Bright Cube Spot Beam LED Cube Light - 70 x 64mm (Each) - Amber	Q2 2021	ILED20BA	2	\$59.00
20W Bright Cube Flood Beam LED Cube Light - 70 x 64mm (Each) - Clear	Q2 2021	ILED20BF	2	\$59.00
20W Bright Cube Flood Beam LED Cube Light - 70 x 64mm (Each) - Amber	Q2 2021	ILED20BFA	2	\$59.00
20W Bright Cube Flood Beam LED Cube Light - 70 x 64mm (Each) - Red	Q2 2021	ILED20BFR	2	\$59.00

DIFF BREATHER KIT

Diff Breather Kit		IDIFFBRE		\$114.00
-------------------	--	----------	--	----------





JT
4/2019+

Jeep Gladiator

PRODUCT DESCRIPTION

PART NO.

QTY Required

RETAIL ea Incl GST

SUSPENSION TO SUIT JEEP GLADIATOR

FRONT SUSPENSION

SHOCK ABSORBER

Nitro Gas - Comfort			12851GRC	2	\$143.75
Nitro Gas - Performance			12851GR	2	\$143.75
Foam Cell Pro - Comfort			45851FEC	2	\$287.50
Foam Cell Pro - Performance			45851FE	2	\$287.50

COIL SPRINGS

	Est. Lift	Additional Load			
Medium	50mm	0 - 60kg	JEEP031B	1	\$235.23

STEERING DAMPER

Foam Cell		Left Hand Drive	3544	1	\$156.82
Foam Cell		Right Hand Drive	3543	1	\$156.82

REAR SUSPENSION

SHOCK ABSORBER

Foam Cell Pro - Comfort			45854FEC	2	\$287.50
Foam Cell Pro - Performance			45854FE	2	\$287.50

COIL SPRINGS

	Est. Lift	Additional Load			
Medium	50mm	0 - 300kg	JEEP032B	1	\$235.23
Heavy	50mm	300kg - 600kg	JEEP032C	1	\$235.23
Extra Heavy	50mm	600kg - GVM	JEEP032D	1	\$235.23

SUSPENSION KITS

Medium - Foam Cell Pro	JEEP032BKP	1	\$1620.44
Heavy - Foam Cell Pro	JEEP032CKP	1	\$1620.44
Extra Heavy - Foam Cell Pro	JEEP032DKP	1	\$1620.44

SUSPENSION KIT CONTENTS

Shock Absorbers Coil Springs

Jeep Grand Cherokee

WK2
8/2013+



PRODUCT DESCRIPTION

PART NO.

QTY
Required

RETAIL
ea Incl GST

ACCESSORIES TO SUIT JEEP GRAND CHEROKEE

STEEL WINCH BULL BARS - ONLY FITS DIESEL LAREDO WITHOUT QUADRA-LIFT SUSPENSION (NO SENSOR HOLES PRE-DRILLED)

Commercial Deluxe

BBCD052

\$1985.00

• Does not suit vehicles with forward facing radar

DIFF BREATHER KIT

Diff Breather Kit

IDIFFBRE

\$114.00





(4x4) WK2
2011+

Jeep Grand Cherokee

PRODUCT DESCRIPTION

PART NO.

QTY
Required

RETAIL
ea Incl GST

SUSPENSION TO SUIT JEEP GRAND CHEROKEE

FRONT SUSPENSION

SHOCK ABSORBER

Nitro Gas - Performance	2011-2016 (Without Sway Bar Bracket)	12735GR	2	\$235.23
Nitro Gas - Performance	2016 + (With Sway Bar Bracket)	12738GR LH/RH	2	\$235.23

• 2016+ vehicles have sway bar bracket attached to lower clevis.

STRUT MOUNTS

Steel Strut Top		ISST052	2	\$104.55
-----------------	--	----------------	---	----------

COIL SPRINGS

	Est. Lift	Additional Load			
Medium	40mm	0 - 50kg	JEEP025B	1	\$235.23
Heavy or Diesel	40mm	50 - 100kg	JEEP025C	1	\$235.23

REAR SUSPENSION

SPACER KIT

Shock Absorber Spacer		1202K	1	\$91.48
-----------------------	--	--------------	---	---------

• No rear shock absorbers available due to Nivomat Shock Absorbers and the affect on vehicle tow rating.

1202K is used to space shock absorber mount to accommodate lift.

COIL SPRINGS

	Est. Lift	Additional Load			
Medium	40mm	0 - 300kg	JEEP026B	1	\$235.23
Heavy	40mm	300 - 600kg	JEEP026C	1	\$235.23

• Nivomat self-levelling rear shock absorber equipped models only. Nivomat shock absorber has a 63mm body size.

Not compatible with 51mm standard shock absorber body.

SUSPENSION KIT

Medium - Nitro Gas	JEEP025BKG	\$1032.38
Heavy - Nitro Gas	JEEP025CKG	\$1032.38

• Vehicles with monocoque body construction can be subject to increased NVH (Noise) with upgraded suspension installed.

SUSPENSION KIT CONTENTS

Strut Shock Absorbers	Shock Absorber Spacers	Coil Springs
-----------------------	------------------------	--------------



Jeep Grand Cherokee

WJ / WG
1999 to 6/2005



PRODUCT DESCRIPTION

PART NO.

QTY
Required

RETAIL
ea Incl GST

SUSPENSION TO SUIT JEEP GRAND CHEROKEE

FRONT SUSPENSION

SHOCK ABSORBER

Nitro Gas - Performance			12774GR	2	\$143.75
-------------------------	--	--	----------------	---	----------

COIL SPRINGS

	Est. Lift	Additional Load			
Medium	40mm	0 - 50kg	JEEP012B	1	\$235.23
Heavy			JEEP012C	1	\$235.23

REAR SUSPENSION

SHOCK ABSORBER

Nitro Gas - Performance			12775GR	2	\$143.75
-------------------------	--	--	----------------	---	----------

COIL SPRINGS

	Est. Lift	Additional Load			
Medium	40mm	0 - 200kg	JEEP013B	1	\$235.23
Heavy			JEEP013C	1	\$235.23

SUSPENSION KIT

Medium - Nitro Gas			JEEP012BKG		\$1045.44
--------------------	--	--	-------------------	--	-----------

• Vehicles with monocoque body construction can be subject to increased NVH (Noise) with upgraded suspension installed

SUSPENSION KIT CONTENTS

Shock Absorbers

Coil Springs





ZJ/ZG
1993 to 1998

Jeep Grand Cherokee

PRODUCT DESCRIPTION

PART NO.

QTY
Required

RETAIL
ea Incl GST

SUSPENSION TO SUIT JEEP GRAND CHEROKEE

FRONT SUSPENSION

SHOCK ABSORBER

Nitro Gas - Performance			12665GR	2	\$143.75
Foam Cell - Performance			24665FE	2	\$209.09

COIL SPRINGS

	Est. Lift	Additional Load			
Medium	40mm	0 - 50kg	JEEP003B	1	\$235.23
Heavy	40mm	50 - 100kg	JEEP016B	1	\$235.23

STEERING DAMPER

Foam Cell			3540	1	\$156.82
-----------	--	--	-------------	---	----------

REAR SUSPENSION

SHOCK ABSORBER

Nitro Gas - Performance			12670GR	2	\$143.75
-------------------------	--	--	----------------	---	----------

COIL SPRINGS

	Est. Lift	Additional Load			
Medium	40mm	0 - 300kg	JEEP006B	1	\$235.23
Heavy	40mm	300kg - GVM	JEEP003B	1	\$235.23

SUSPENSION KIT

Medium - Nitro Gas	JEEP006BKG	\$1045.44
Heavy - Nitro Gas	JEEP006CKG	\$1045.44

- Vehicles with monocoque body construction can be subject to increased NVH (Noise) with upgraded suspension installed
- Specify front Coil Springs when ordering

SUSPENSION KIT CONTENTS

Shock Absorbers Coil Springs





PRODUCT DESCRIPTION

DATE AVAILABLE

PART NO.

QTY
RequiredRETAIL
ea Incl GST

ACCESSORIES TO SUIT JEEP WRANGLER

STEEL WINCH BULL BARS

Raid Full Length Steel Bumper*	Q2 2021	BBR077		\$1260.00
Raid Stubby Bumper*	Q2 2021	BBR077ST		\$1120.00
Driving Light Patch Loom		IPL077		\$34.00

* Compatible with Ironman 4x4 Cube Lights and Lightbars, refer below for available options

LIGHTING OPTIONS - TO SUIT RAID BULL BARS

105W Bright Sabre-X Single Row Slim Lightbar 522mm (20") Straight	Q2 2021	ILBSR003B	1	\$210.00
40W Bright Cube Spot Beam LED Cube Light - 81 x 75mm (Each) - Clear	Q2 2021	ILED80B	2	\$79.00
40W Bright Cube Spot Beam LED Cube Light - 81 x 75mm (Each) - Amber	Q2 2021	ILED80BA	2	\$79.00
40W Bright Cube Flood Beam LED Cube Light - 81 x 75mm (Each) - Clear	Q2 2021	ILED80BF	2	\$79.00
40W Bright Cube Flood Beam LED Cube Light - 81 x 75mm (Each) - Amber	Q2 2021	ILED80BFA	2	\$79.00

STEEL SIDE STEPS

Raid Rock Sliders	Q2 2021	SS077JL		\$848.00
-------------------	---------	---------	--	----------

REAR PROTECTION AND TOWING

Raid Steel Rear Bumper* ^Δ	Q2 2021	RTB077JL		\$950.00
Class 3 Tow Bar (3500lb)	Q2 2021	TB077JL		\$175.00
Spare Tyre Relocation Kit [†]	Q2 2021	RWC077JL		\$320.00

* Compatible with Ironman 4x4 Cube Lights, refer below for available options

[†] Compatible up to 37" tyres

^Δ Recommend installation of RWC077JL to raise spare wheel and licence plate relocation

LIGHTING OPTIONS - TO SUIT RAID REAR BARS

20W Bright Cube Spot Beam LED Cube Light - 70 x 64mm (Each) - Clear	Q2 2021	ILED20B	2	\$59.00
20W Bright Cube Spot Beam LED Cube Light - 70 x 64mm (Each) - Amber	Q2 2021	ILED20BA	2	\$59.00
20W Bright Cube Flood Beam LED Cube Light - 70 x 64mm (Each) - Clear	Q2 2021	ILED20BF	2	\$59.00
20W Bright Cube Flood Beam LED Cube Light - 70 x 64mm (Each) - Amber	Q2 2021	ILED20BFA	2	\$59.00
20W Bright Cube Flood Beam LED Cube Light - 70 x 64mm (Each) - Red	Q2 2021	ILED20BFR	2	\$59.00





JL (4 Door)
2018+

Jeep Wrangler

PRODUCT DESCRIPTION

PART NO.

QTY Required

RETAIL ea Incl GST

SUSPENSION TO SUIT JEEP WRANGLER

FRONT SUSPENSION

SHOCK ABSORBER

Nitro Gas - Comfort			12851GRC	2	\$143.75
Nitro Gas - Performance			12851GR	2	\$143.75
Foam Cell Pro - Comfort			45851FEC	2	\$287.50
Foam Cell Pro - Performance			45851FE	2	\$287.50

COIL SPRINGS

	Est. Lift	Additional Load			
Light	45mm	0 - 50kg	JEEP029A	1	\$235.23
Medium	50mm	0 - 50kg	JEEP029B	1	\$235.23
Heavy	50mm	50 - 100kg	JEEP029C	1	\$235.23

STEERING DAMPER

Foam Cell	Left Hand Drive	3544	1	\$156.82
Foam Cell	Right Hand Drive	3543	1	\$156.82

REAR SUSPENSION

SHOCK ABSORBER

Nitro Gas - Comfort			12852GRC	2	\$143.75
Nitro Gas - Performance			12852GR	2	\$143.75
Foam Cell Pro - Comfort			45852FEC	2	\$287.50
Foam Cell Pro - Performance			45852FE	2	\$287.50

COIL SPRINGS

	Est. Lift	Additional Load			
Light - (2 Door Models)	45mm	0 - 100kg	JEEP030A	1	\$235.23
Medium	50mm	0 - 250kg	JEEP030B	1	\$235.23
Heavy	50mm	200kg - GVM	JEEP030C	1	\$235.23

SUSPENSION KITS

Light - Nitro Gas	JEEP030AKG	1	\$1045.44
Light - Foam Cell Pro	JEEP030AKP	1	\$1620.44
Medium - Nitro Gas	JEEP030BKG	1	\$1045.44
Medium - Foam Cell Pro	JEEP030BKP	1	\$1620.44
Heavy - Nitro Gas	JEEP030CKG	1	\$1045.44
Heavy - Foam Cell Pro	JEEP030CKP	1	\$1620.44

SUSPENSION KIT CONTENTS

Shock Absorbers	Coil Springs
-----------------	--------------

Jeep Wrangler

JK
2007+



PRODUCT DESCRIPTION

DATE AVAILABLE

PART NO.

QTY
Required

RETAIL
ea Incl GST

ACCESSORIES TO SUIT JEEP WRANGLER

STEEL WINCH BULL BARS - MUST USE OE FOG LIGHTS

Commercial Deluxe		BBCD035		\$1985.00
Raid Full Length Steel Bumper*	Q2 2021	BBR077		\$1260.00
Raid Stubby Bumper*	Q2 2021	BBR077ST		\$1120.00

* Compatible with Ironman 4x4 Cube Lights and Lightbars, refer below for available options

LIGHTING OPTIONS - TO SUIT RAID BULL BARS

105W Bright Sabre-X Single Row Slim Lightbar 522mm (20") Straight	Q2 2021	ILBSR003B	1	\$210.00
40W Bright Cube Spot Beam LED Cube Light - 81 x 75mm (Each) - Clear	Q2 2021	ILED80B	2	\$79.00
40W Bright Cube Spot Beam LED Cube Light - 81 x 75mm (Each) - Amber	Q2 2021	ILED80BA	2	\$79.00
40W Bright Cube Flood Beam LED Cube Light - 81 x 75mm (Each) - Clear	Q2 2021	ILED80BF	2	\$79.00
40W Bright Cube Flood Beam LED Cube Light - 81 x 75mm (Each) - Amber	Q2 2021	ILED80BFA	2	\$79.00

DIFF BREATHER KIT

Diff Breather Kit		IDIFFBRE		\$114.00
-------------------	--	----------	--	----------



Jeep Wrangler

JK
2006+

PRODUCT DESCRIPTION

PART NO.

QTY
RequiredRETAIL
ea Incl GST

SUSPENSION TO SUIT JEEP WRANGLER

FRONT SUSPENSION

SHOCK ABSORBER

Nitro Gas - Performance			12751GR	2	\$143.75
Nitro Gas - Performance	Suits 4" Lift		12751LGR	2	\$143.75
Foam Cell Pro - Performance			45751FE	2	\$287.50
Foam Cell Pro - Performance	Suits 4" Lift		45751LFE	2	\$300.57

COIL SPRINGS

	Est. Lift	Additional Load			
Medium	40mm	0 - 50kg	JEEP017B	1	\$235.23
Medium - 4" Lift	100mm	0 - 50kg	JEEP019B	1	\$274.43
Heavy	40mm	50 - 110kg	JEEP017C	1	\$235.23

STEERING DAMPER

Foam Cell	Regular Fitment	3541	1	\$156.82
Foam Cell	Suits JKBKITL 4" Kit Only	3540	1	\$156.82

PANHARD ROD

Adjustable Panhard Rod	PANHARD010	1	\$300.57
------------------------	-------------------	---	----------

REAR SUSPENSION

SHOCK ABSORBER

Nitro Gas - Performance			12752GR	2	\$143.75
Nitro Gas - Performance	Suits 4" Lift		12752LGR	2	\$143.75
Foam Cell Pro - Performance			45752FE	2	\$287.50
Foam Cell Pro - Performance	Suits 4" Lift		45752LFE	2	\$300.57

COIL SPRINGS

	Est. Lift	Additional Load			
Medium - 2 Door	40mm	0 - 250kg	JEEP018A	1	\$235.23
Medium - 4 Door	40mm	0 - 250kg	JEEP018B	1	\$235.23
Medium - 4" Lift	100mm	0 - 250kg	JEEP020B	1	\$274.43

PANHARD ROD

Adjustable Panhard Rod	PANHARD011	1	\$300.57
------------------------	-------------------	---	----------

SWAY BAR LINK

Extended Sway Bar Link	SBEXT008	2	\$78.41
------------------------	-----------------	---	---------

- OEM Rear Links can be moved to the front of vehicle.

BRACKET KIT

4" Lift Bracket Set	Left Hand Drive Models ONLY	JKBKITL	1	\$1816.46
---------------------	-----------------------------	----------------	---	-----------

- Bracket set is sold complete. Parts are not available individually

SUSPENSION KIT

Light - Nitro Gas	2 Door	JEEP017AKG	\$1045.44
Light - Foam Cell Pro	2 Door	JEEP017AKP	\$1620.44
Medium - Nitro Gas	4 Door	JEEP017BKG	\$1045.44
Medium - Nitro Gas	4" Lift	JEEP019BKGL	\$3097.12
Medium - Foam Cell Pro	4 Door	JEEP017BKP	\$1620.44
Medium - Foam Cell Pro	4" Lift	JEEP019BKPL	\$3724.38

- 4" Lift may not be legal for road use in your area. Certification may be required for on-road use
- 4" Lift Kit suits left hand drive models ONLY
- 4" Lift components should only be used together with appropriate geometry correction components

SUSPENSION KIT CONTENTS

Shock Absorbers Coil Springs

4" SUSPENSION KIT CONTENTS

Shock Absorbers Steering Damper
Coil Springs 4" Bracket Set

4" BRACKET SET CONTENTS

Steering Rod Flip Kit - JKBK01L
Front Shock Absorber Relocation Kit - JKBK02
Radius Arm Relocation Kit - JKBK03
Brake Hose Extension Kit - JKBK04
Front Adjustable Panhard Rod - PANHARD010Rear Adjustable Panhard Rod - PANHARD012
Rear Panhard Rod Relocation Kit - JKBK05L
Bump Stop Spacer Kit - JKBK06
Adjustable Swaybar Extensions - SBEXT008

- Fitment to RHD is possible with omission of JKBK01L and JKBK05L



PRODUCT DESCRIPTION

PART NO.

QTY
Required

RETAIL
ea Incl GST

SUSPENSION TO SUIT JEEP WRANGLER

FRONT SUSPENSION

SHOCK ABSORBER

Nitro Gas - Performance			12665GR	2	\$143.75
Foam Cell - Performance			24665FE	2	\$209.09

COIL SPRINGS

	Est. Lift	Additional Load			
Medium	40mm	0 - 40kg	JEEP007B	1	\$235.23
Heavy	40mm	40 - 80kg	JEEP003B	1	\$235.23

STEERING DAMPER

Foam Cell			3540	1	\$156.82
-----------	--	--	-------------	---	----------

REAR SUSPENSION

SHOCK ABSORBER

Nitro Gas - Performance			12669GR	2	\$143.75
-------------------------	--	--	----------------	---	----------

COIL SPRINGS

	Est. Lift	Additional Load			
Medium	40mm	0 - 200kg	JEEP008B	1	\$235.23

• In some cases a driveline vibration may occur after lift, a gearbox crossmember spacer may be required

SUSPENSION KIT

Medium - Nitro Gas			JEEP007BKG		\$1045.44
--------------------	--	--	-------------------	--	-----------

- In some cases a driveline vibration may occur after lift, a gearbox crossmember spacer may be required
- Specify front Coil Springs when ordering

SUSPENSION KIT CONTENTS

Shock Absorbers Coil Springs



2014+

PRODUCT DESCRIPTION

PART NO.

QTY
RequiredRETAIL
ea Incl GST

SUSPENSION TO SUIT JMC VIGUS

FRONT SUSPENSION

SHOCK ABSORBER

Nitro Gas Strut - Performance			12710GR	2	\$209.09
Foam Cell Strut - Performance			24710FE	2	\$235.23
Foam Cell Pro Strut - Performance			45710FE	2	\$365.91

- Height adjustable with Ironman 4x4 Strut Trim Packers

COIL SPRINGS

	Est. Lift	Additional Load			
Medium	45mm	0 - 50kg	TOY038C	1	\$235.23
Heavy	45mm	50 - 110kg	TOY055A	1	\$235.23

STRUT MOUNTS

Steel Strut Top			ISST001	2	\$78.41
-----------------	--	--	---------	---	---------

TRIM PACKERS

5mm Strut Trim Packer	Nitro Gas / Foam Cell	HILFR05 / HILFR05F	2	\$26.14
10mm Strut Trim Packer	Nitro Gas / Foam Cell	HILFR10 / HILFR10F	2	\$26.14
15mm Strut Trim Packer	Nitro Gas / Foam Cell	HILFR15 / HILFR15F	2	\$26.14

- ONLY Compatible with Ironman 4x4 Struts (except Pro), lift height subject to 2:1 motion ratio. Unnecessary fitment may lift vehicle too high

REAR SUSPENSION

SHOCK ABSORBER

Nitro Gas - Comfort			12650GRC	2	\$143.75
Nitro Gas - Performance			12650GR	2	\$143.75
Foam Cell - Comfort			24650FEC	2	\$209.09
Foam Cell - Performance			24650FE	2	\$209.09
Foam Cell - Professional			24650FEP	2	\$209.09
Foam Cell Pro - Comfort			45650FEC	2	\$287.50
Foam Cell Pro - Performance			45650FE	2	\$287.50
Foam Cell Pro - Professional			45650FEP	2	\$287.50

LEAF SPRINGS

	Est. Lift	Additional Load			
Medium	40mm	0 - 200kg	JMC002B	2	\$352.84
Heavy	40mm	200 - 400kg	JMC002C	2	\$378.98

U-BOLTS

U-Bolt Kit			437UBKL	2	\$39.21
------------	--	--	---------	---	---------

POLYURETHANE SPRING BUSHES

Bush Kit			767UK	1	\$78.41
----------	--	--	-------	---	---------

GREASABLE SHACKLES AND PINS

Greasable Shackle			386-3	2	\$52.28
Non-Greasable Pin			387-1	2	\$26.14

HELPER SPRINGS

Load Plus Helper Springs			LP2	1	\$156.82
Add-A-Leaf			ISL6010	1	\$156.82

SUSPENSION KIT

Medium - Nitro Gas		JMC002BKG	\$1803.39
Medium - Foam Cell		JMC002BKF	\$1986.34
Medium - Foam Cell Pro		JMC002BKP	\$2404.52
Heavy - Nitro Gas		JMC002CKG	\$1855.66
Heavy - Foam Cell		JMC002CKF	\$2038.61
Heavy - Foam Cell Pro		JMC002CKP	\$2456.79

- Specify Front Coil Springs when ordering

SUSPENSION KIT CONTENTS

Shock Absorbers	Coil Springs	U-Bolts
Strut Shock Absorbers	Leaf Springs	Polyurethane Spring Bushes

Kia Sorento

BL
2003 to 2008



PRODUCT DESCRIPTION

PART NO.

QTY
Required

RETAIL
ea Incl GST

SUSPENSION TO SUIT KIA SORENTO

FRONT SUSPENSION

COIL SPRINGS

	Est. Lift	Additional Load	PART NO.	QTY	RETAIL
Medium	35mm	0 - 50kg	KIA006B	1	\$235.23

REAR SUSPENSION

COIL SPRINGS

	Est. Lift	Additional Load	PART NO.	QTY	RETAIL
Medium	35mm	0 - 200kg	KIA007B	1	\$235.23





1978+

Lada Niva

PRODUCT DESCRIPTION

PART NO.

QTY
Required

RETAIL
ea Incl GST

SUSPENSION TO SUIT LADA NIVA

FRONT SUSPENSION

COIL SPRINGS

	Est. Lift	Additional Load			
Medium	35mm	0 - 50kg	LADA001B	1	\$235.23

REAR SUSPENSION

COIL SPRINGS

	Est. Lift	Additional Load			
Medium	35mm	0 - 200kg	LADA002B	1	\$235.23



Alu-Cab™

ULTIMATE OVERLAND PRODUCTS



ICARUS

Roof conversion
to Suit Defender 110

for a full range of alu-cab visit our website

www.alu-cab.com.au

distributed by





2007 to 2016

Land Rover Defender

PRODUCT DESCRIPTION
PART NO.
QTY
Required

RETAIL
ea Incl GST

ACCESSORIES TO SUIT LAND ROVER DEFENDER

STEEL WINCH BULL BARS - NON-AIRBAG MODELS ONLY

Commercial (Tube Style) - <i>While Stocks Last</i>	BBC023	\$1569.00
--	--------	-----------

LOCKSAFE DRAWER SYSTEMS

Twin Drawers - 1000mm	ITD1000	\$1296.00
Single Drawer - 1000mm	ISD1000	\$783.00

STEEL ROOF RACKS

Cage Style - 1.4m x 1.25m	IRRCAGE14	\$709.00
Cage Style - 1.8m x 1.25m	IRRCAGE18	\$744.00
Cage Style - 2.2m x 1.25m	IRRCAGE22	\$772.00
Rooftop Tent Compatible - 1.8m x 1.25m	IRRTENT18	\$709.00
Rooftop Tent Compatible - 2.2m x 1.25m	IRRTENT22	\$744.00
Trade Style - 1.8m x 1.25m (Open end)	IRRTRADE18	\$709.00
Trade Style - 2.2m x 1.25m (Open end)	IRRTRADE22	\$738.00

ALLOY ROOF RACKS

Cage Style - 1.4m x 1.25m	IRRCAGE14-ALLOY	\$897.00
Cage Style - 1.8m x 1.25m	IRRCAGE18-ALLOY	\$1049.00
Cage Style - 2.2m x 1.25m	IRRCAGE22-ALLOY	\$1106.00
Trade Style - 1.4m x 1.25m (Open end)	IRROPEN14-ALLOY	\$886.00
Trade Style - 1.8m x 1.25m (Open end)	IRRTRADE18-ALLOY	\$1033.00
Trade Style - 2.2m x 1.25m (Open end)	IRRTRADE22-ALLOY	\$1078.00
Flat Rack - 1.8m x 1.25m	IRRTFLAT18-ALLOY	\$1019.00

ROOF RACK - MOUNTING KITS

Gutter Mount Feet - 210mm (8 Feet)	IRRFET210	\$199.00
------------------------------------	-----------	----------

DIFF BREATHER KIT

Diff Breather Kit	IDIFFBRE	\$114.00
-------------------	----------	----------



PRODUCT DESCRIPTION

PART NO.

QTY
Required

RETAIL
ea Incl GST

SUSPENSION TO SUIT LAND ROVER DEFENDER

FRONT SUSPENSION

SHOCK ABSORBER

Nitro Gas - Performance			12080GR	2	\$143.75
Foam Cell - Performance			24080FE	2	\$209.09
Foam Cell Pro - Performance			45080FE	2	\$287.50

COIL SPRINGS

	Est. Lift	Additional Load			
Medium - V8 Petrol Engine	45mm	0 - 80kg	LAND007B	1	\$235.23
Medium - 2.5 Puma Engine	45mm	0 - 80kg	LAND009B	1	\$235.23
Medium - 2.2 Puma Engine	45mm	0 - 80kg	LAND014B	1	\$235.23

STEERING DAMPER

Foam Cell			3532	1	\$156.82
-----------	--	--	-------------	---	----------

OFFSET CASTER BUSH KIT

Offset Bush Kit	Suits 1987+		1145SK	1	\$143.75
-----------------	-------------	--	---------------	---	----------

• May cause driveline vibration on 1998+ models

REAR SUSPENSION

SHOCK ABSORBER

Nitro Gas - Performance			12640GR	2	\$143.75
Foam Cell - Performance			24640FE	2	\$209.09
Foam Cell Pro - Performance			45640FE	2	\$287.50

COIL SPRINGS

	Est. Lift	Additional Load			
Medium - (Self Leveling)	45mm	0 - 300kg	LAND008B	1	\$235.23
Medium	45mm	0 - 300kg	LAND006B	1	\$248.30
Heavy	45mm	300kg - GVM	LAND006C	1	\$261.36

• Re-Fit inner spring if equipped

SUSPENSION KIT

Medium - Nitro Gas - (Self Leveling)	LAND005BKG	\$1045.44
Medium - Foam Cell - (Self Leveling)	LAND005BKF	\$1306.80
Medium - Foam Cell Pro - (Self Leveling)	LAND005BKP	\$1620.44
Medium - Nitro Gas	LAND006BKG	\$1058.51
Medium - Foam Cell	LAND006BKF	\$1319.87
Medium - Foam Cell Pro	LAND006BKP	\$1633.50
Heavy - Nitro Gas	LAND006CKG	\$1071.58
Heavy - Foam Cell	LAND006CKF	\$1332.94
Heavy - Foam Cell Pro	LAND006CKP	\$1646.57

• Specify front Coil Springs when ordering

SUSPENSION KIT CONTENTS

Shock Absorbers Coil Springs



110 Series Trayback

Land Rover Defender

PRODUCT DESCRIPTION

PART NO.

QTY
Required

RETAIL
ea Incl GST

SUSPENSION TO SUIT LAND ROVER DEFENDER

FRONT SUSPENSION

SHOCK ABSORBER

Nitro Gas - Performance			12080GR	2	\$143.75
Foam Cell - Performance			24080FE	2	\$209.09
Foam Cell Pro - Performance			45080FE	2	\$287.50

COIL SPRINGS

	Est. Lift	Additional Load			
Medium - V8 Petrol Engine	45mm	0 - 80kg	LAND007B	1	\$235.23
Medium - 2.5 Puma Engine	45mm	0 - 80kg	LAND009B	1	\$235.23
Medium - 2.2 Puma Engine	45mm	0 - 80kg	LAND014B	1	\$235.23

STEERING DAMPER

Foam Cell			3532	1	\$156.82
-----------	--	--	-------------	---	----------

OFFSET CASTER BUSH KIT

Offset Bush Kit	Suits 1987+		1145SK	1	\$143.75
-----------------	-------------	--	---------------	---	----------

• May cause driveline vibration on 1998+ models

REAR SUSPENSION

SHOCK ABSORBER

Nitro Gas - Performance			12640GR	2	\$143.75
Foam Cell - Performance			24640FE	2	\$209.09
Foam Cell Pro - Performance			45640FE	2	\$287.50

COIL SPRINGS

	Est. Lift	Additional Load			
Medium	45mm	0 - 300kg	LAND006B	1	\$248.30
Heavy	45mm	300kg - GVM	LAND006C	1	\$261.36

SUSPENSION KIT

Medium - Nitro Gas			LAND007BKG		\$1058.51
Medium - Foam Cell			LAND007BKF		\$1319.87
Medium - Foam Cell Pro			LAND007BKP		\$1633.50
Heavy - Nitro Gas			LAND007CKG		\$1071.58
Heavy - Foam Cell			LAND007CKF		\$1332.94
Heavy - Foam Cell Pro			LAND007CKP		\$1646.57

• Specify front Coil Springs when ordering

SUSPENSION KIT CONTENTS

Shock Absorbers Coil Springs



PRODUCT DESCRIPTION

PART NO.

QTY
Required

RETAIL
ea Incl GST

SUSPENSION TO SUIT LAND ROVER DEFENDER

FRONT SUSPENSION

SHOCK ABSORBER

Nitro Gas - Performance			12080GR	2	\$143.75
Foam Cell - Performance			24080FE	2	\$209.09
Foam Cell Pro - Performance			45080FE	2	\$287.50

COIL SPRINGS

	Est. Lift	Additional Load			
Medium	45mm	0 - 80kg	LAND009B	1	\$235.23

STEERING DAMPER

Foam Cell			3532	1	\$156.82
-----------	--	--	-------------	---	----------

OFFSET CASTER BUSH KIT

Offset Bush Kit		Suits 1987+	1145SK	1	\$143.75
-----------------	--	-------------	---------------	---	----------

• May cause driveline vibration on 1998+ models

REAR SUSPENSION

SHOCK ABSORBER

Nitro Gas - Performance			12640GR	2	\$143.75
Foam Cell - Performance			24640FE	2	\$209.09
Foam Cell Pro - Performance			45640FE	2	\$287.50

COIL SPRINGS

	Est. Lift	Additional Load			
Medium	45mm	0 - 300kg	LAND011B	1	\$235.23
Heavy	45mm	300kg - GVM	LAND011C	1	\$261.36

SUSPENSION KIT

Medium - Nitro Gas	LAND009BKG	\$1045.44
Medium - Foam Cell	LAND009BKF	\$1306.80
Medium - Foam Cell Pro	LAND009BKP	\$1620.44
Heavy - Nitro Gas	LAND009CKG	\$1071.58
Heavy - Foam Cell	LAND009CKF	\$1332.94
Heavy - Foam Cell Pro	LAND009CKP	\$1646.57

SUSPENSION KIT CONTENTS

Shock Absorbers

Coil Springs



(Coil Springs)
1971 to 1995

Land Rover Range Rover

PRODUCT DESCRIPTION

PART NO.

QTY
Required

RETAIL
ea Incl GST

SUSPENSION TO SUIT LAND ROVER RANGE ROVER

FRONT SUSPENSION

SHOCK ABSORBER

Nitro Gas - Performance			12080GR	2	\$143.75
Foam Cell - Performance			24080FE	2	\$209.09
Foam Cell Pro - Performance			45080FE	2	\$287.50

COIL SPRINGS

	Est. Lift	Additional Load			
Medium	40mm	0 - 50kg	LAND009B	1	\$235.23
Heavy	40mm	50 - 110kg	LAND007B	1	\$235.23

STEERING DAMPER

Foam Cell			3511	1	\$156.82
-----------	--	--	-------------	---	----------

OFFSET CASTER BUSH KIT

Offset Bush Kit		Suits 1986+	1145SK	1	\$143.75
-----------------	--	-------------	---------------	---	----------

• May cause driveline vibration in automatic transmission models

REAR SUSPENSION

SHOCK ABSORBER

Nitro Gas - Performance			12640GR	2	\$143.75
Foam Cell - Performance			24640FE	2	\$209.09
Foam Cell Pro - Performance			45640FE	2	\$287.50

COIL SPRINGS

	Est. Lift	Additional Load			
Medium	40mm	0 - 300kg	LAND011B	1	\$235.23
Heavy	40mm	300kg - GVM	LAND011C	1	\$261.36

SUSPENSION KIT

Medium - Nitro Gas	LAND009BKG	\$1045.44
Medium - Foam Cell	LAND009BKF	\$1306.80
Medium - Foam Cell Pro	LAND009BKP	\$1620.44
Heavy - Nitro Gas	LAND009CKG	\$1071.58
Heavy - Foam Cell	LAND009CKF	\$1332.94
Heavy - Foam Cell Pro	LAND009CKP	\$1646.57

• Specify front Coil Springs when ordering

SUSPENSION KIT CONTENTS

Shock Absorbers

Coil Springs

Land Rover Discovery

Series 2, 3 and 4



PRODUCT DESCRIPTION

PART NO.

QTY
Required

RETAIL
ea Incl GST

ACCESSORIES TO SUIT LAND ROVER DISCOVERY

LOCKSAFE DRAWER SYSTEMS

Twin Drawers - 900mm - Fits Discovery 2 Only
Single Drawer - 900mm

ITD900
ISD900

\$1242.00
\$767.00

UNDERBODY PROTECTION

Engine Bay and Transmission - Fits Discovery 3 / 4 / Range Rover Sport 2005 - 2013

IUP016K

\$636.00

DIFF BREATHER KIT

Diff Breather Kit

IDIFFBRE

\$114.00





Series 3 LR3 (Coil Springs)
2004 to 2009

SUSPENSION TO SUIT

Land Rover Discovery

PRODUCT DESCRIPTION

PART NO.

QTY
Required

RETAIL
ea Incl GST

SUSPENSION TO SUIT LAND ROVER DISCOVERY

FRONT SUSPENSION

COIL SPRINGS	Est. Lift	Additional Load			
Medium	45mm	0 - 50kg	LAND019B	1	\$235.23
Heavy	45mm	50 - 100kg	LAND019C	1	\$217.80

REAR SUSPENSION

COIL SPRINGS	Est. Lift	Additional Load			
Medium	45mm	0 - 200kg	LAND020B	1	\$274.43
Heavy	45mm	200kg - GVM	LAND020C	1	\$254.10



PRODUCT DESCRIPTION

PART NO.

QTY
Required

RETAIL
ea Incl GST

SUSPENSION TO SUIT LAND ROVER DISCOVERY

FRONT SUSPENSION

SHOCK ABSORBER

Nitro Gas - Performance			12776GR	2	\$143.75
Foam Cell - Performance			24776FE	2	\$209.09

COIL SPRINGS

	Est. Lift	Additional Load			
Medium	40mm	0 - 50kg	LAND014B	1	\$235.23
Heavy	40mm	50 - 110kg	LAND009B	1	\$235.23

STEERING DAMPER

Foam Cell			3502	1	\$156.82
-----------	--	--	-------------	---	----------

REAR SUSPENSION

SHOCK ABSORBER

Nitro Gas - Performance			12777GR	2	\$143.75
Foam Cell - Performance			24777FE	2	\$209.09

COIL SPRINGS

	Est. Lift	Additional Load			
Medium	40mm	0 - 300kg	LAND011B	1	\$235.23
Heavy	40mm	300kg - GVM	LAND011C	1	\$261.36

SUSPENSION KIT

Medium - Nitro Gas	LAND014BKG	\$1045.44
Medium - Foam Cell	LAND014BKF	\$1306.80
Heavy - Nitro Gas	LAND014CKG	\$1071.58
Heavy - Foam Cell	LAND014CKF	\$1332.94

• Specify front Coil Springs when ordering

SUSPENSION KIT CONTENTS

Shock Absorbers Coil Springs



Series 1
1989 to 1998

Land Rover Discovery

PRODUCT DESCRIPTION

PART NO.

QTY
Required

RETAIL
ea Incl GST

SUSPENSION TO SUIT LAND ROVER DISCOVERY

FRONT SUSPENSION

SHOCK ABSORBER

Nitro Gas - Performance			12080GR	2	\$143.75
Foam Cell - Performance			24080FE	2	\$209.09
Foam Cell Pro - Performance			45080FE	2	\$287.50

COIL SPRINGS

	Est. Lift	Additional Load			
Medium	40mm	0 - 50kg	LAND009B	1	\$235.23
Heavy	40mm	50 - 110kg	LAND007B	1	\$235.23

STEERING DAMPER

Foam Cell			3511	1	\$156.82
-----------	--	--	-------------	---	----------

OFFSET CASTER BUSH KIT

Offset Bush Kit			1145SK	1	\$143.75
-----------------	--	--	---------------	---	----------

• May cause driveline vibration in automatic transmission models

REAR SUSPENSION

SHOCK ABSORBER

Nitro Gas - Performance			12640GR	2	\$143.75
Foam Cell - Performance			24640FE	2	\$209.09
Foam Cell Pro - Performance			45640FE	2	\$287.50

COIL SPRINGS

	Est. Lift	Additional Load			
Medium	40mm	0 - 300kg	LAND011B	1	\$235.23
Heavy	40mm	300kg - GVM	LAND011C	1	\$261.36

SUSPENSION KIT

Medium - Nitro Gas	LAND009BKG	\$1045.44
Medium - Foam Cell	LAND009BKF	\$1306.80
Medium - Foam Cell Pro	LAND009BKP	\$1620.44
Heavy - Nitro Gas	LAND009CKG	\$1071.58
Heavy - Foam Cell	LAND009CKF	\$1332.94
Heavy - Foam Cell Pro	LAND009CKP	\$1646.57

• Specify front Coil Springs when ordering

SUSPENSION KIT CONTENTS

Shock Absorbers

Coil Springs

LDV T60

2.8L Turbo Diesel
2017+



PRODUCT DESCRIPTION

PART NO.

QTY
Required

RETAIL
ea Incl GST

ACCESSORIES TO SUIT LDV T60

STEEL WINCH BULL BARS

Commercial Deluxe **BBCD068** \$1985.00

• Winch with Steel Cable and Roller Fairlead is not suitable - Use Winch with Synthetic Rope and Alloy Hawse only

CANOPY - ABS PLASTIC (SIDE LIFT UP WINDOWS AND CENTRAL LOCKING REAR DOOR) - FITS 4X4 AND 4X2 DUAL CAB MODELS

Pre-Primed **CANOPY015-P** \$3143.00*

* Pre-primed canopies, plus colour coding.

CANOPY - SMOOTH FINISH FIBREGLASS PINNACLE (SIDE LIFT UP WINDOWS AND CENTRAL LOCKING REAR DOOR) - FITS 4X4 AND 4X2 DUAL CAB MODELS

Pre-Primed **CANFIBRE051-P** \$2783.00*

* Pre-primed canopies, plus colour coding.

DIFF BREATHER KIT

Diff Breather Kit **IDIFFBRE** \$114.00

SUSPENSION TO SUIT LDV

FRONT SUSPENSION

SHOCK ABSORBER

Nitro Gas Strut - Performance **12745GR** 2 \$209.09

Foam Cell Strut - Performance **24745FE** 2 \$235.23

Foam Cell Pro Strut - Performance **45745FE** 2 \$365.91

• Height adjustable with Ironman 4x4 Strut Trim Packers

COIL SPRINGS

	Est. Lift	Additional Load		
Medium	40mm	0 - 50kg	HOLD020A	1 \$235.23
Heavy	40mm	50 - 110kg	HOLD020B	1 \$235.23

STRUT MOUNTS

Steel Strut Top **ISST017** 2 \$78.41

TRIM PACKERS

5mm Strut Trim Packer	Nitro Gas / Foam Cell	HILFR05 / HILFR05F	2	\$26.14
10mm Strut Trim Packer	Nitro Gas / Foam Cell	HILFR10 / HILFR10F	2	\$26.14
15mm Strut Trim Packer	Nitro Gas / Foam Cell	HILFR15 / HILFR15F	2	\$26.14

• ONLY Compatible with Ironman 4x4 Struts (except Pro), lift height subject to 2:1 motion ratio. Unnecessary fitment may lift vehicle too high

CONTROL ARMS

Pro-Forge Upper Control Arms **UCA041FA** 1 \$831.60

REAR SUSPENSION

SHOCK ABSORBER

Nitro Gas - Comfort **12636GRC** 2 \$143.75

Nitro Gas - Performance **12636GR** 2 \$143.75

Nitro Gas - Professional **12636GRP** 2 \$143.75

Foam Cell - Comfort **24636FEC** 2 \$209.09

Foam Cell - Performance **24636FE** 2 \$209.09

Foam Cell - Professional **24636FEP** 2 \$209.09

Foam Cell Pro - Comfort **45636FEC** 2 \$287.50

Foam Cell Pro - Performance **45636FE** 2 \$287.50

Foam Cell Pro - Professional **45636FEP** 2 \$287.50

LEAF SPRINGS

	Est. Lift	Additional Load		
Medium	45mm	0 - 200kg	HOLD021A	2 \$378.98
Heavy	45mm	200 - 400kg	HOLD021B	2 \$378.98
Extra Heavy	45mm	400kg - 800kg	HOLD021C	2 \$392.04
Super Heavy	45mm	800kg - GVM	HOLD021D	2 \$392.04

U-BOLTS

U-Bolt Kit **437UBKL** 2 \$39.21

POLYURETHANE SPRING BUSHES

Bush Kit **770UK** 1 \$156.82

SPACER KIT

Headlight Bracket Extension Kit **1207K** 1 \$26.14

Centre Bearing Spacer Kit **1208K** 1 \$26.14

GREASABLE SHACKLES AND PINS

Greasable Shackle **1148** 2 \$52.28

Non-Greasable Pin **387-1** 2 \$26.14

HELPER SPRINGS

Add-A-Leaf **ISL6010** 1 \$156.82

Load Plus Helper Springs **LP2** 1 \$156.82





2.8L Turbo Diesel
2017+

SUSPENSION TO SUIT

LDV T60

PRODUCT DESCRIPTION

PART NO.

QTY
Required

RETAIL
ea Incl GST

SUSPENSION KIT

Medium - Nitro Gas	HOLD021AKG2	\$1973.27
Medium - Foam Cell	HOLD021AKF2	\$2156.22
Medium - Foam Cell Pro	HOLD021AKP2	\$2574.40
Heavy - Nitro Gas	HOLD021BKG2	\$1973.27
Heavy - Foam Cell	HOLD021BKF2	\$2156.22
Heavy - Foam Cell Pro	HOLD021BKP2	\$2574.40
Extra Heavy - Nitro Gas	HOLD021CKG2	\$1999.41
Extra Heavy - Foam Cell	HOLD021CKF2	\$2182.36
Extra Heavy - Foam Cell Pro	HOLD021CKP2	\$2600.54
Super Heavy - Nitro Gas	HOLD021DKG2	\$1999.41
Super Heavy - Foam Cell	HOLD021DKF2	\$2182.36
Super Heavy - Foam Cell Pro	HOLD021DKP2	\$2600.54

• Specify front Coil Springs when ordering

SUSPENSION KIT CONTENTS

Shock Absorbers	Coil Springs	U-Bolts	Headlight Bracket Kit
Strut Shock Absorbers	Leaf Springs	Polyurethane Spring Bushes	

Mahindra Scorpio

Getaway Pik-Up
2002 to 2016



PRODUCT DESCRIPTION

PART NO.

QTY
Required

RETAIL
ea Incl GST

SUSPENSION TO SUIT MAHINDRA SCORPIO

FRONT SUSPENSION

SHOCK ABSORBER

Nitro Gas - Performance		12087GR	2	\$143.75
-------------------------	--	----------------	---	----------

TORSION BAR

Up-rated Torsion Bars		MAH001	1	\$392.04
-----------------------	--	---------------	---	----------

• Minimum 60mm downward suspension travel required after adjustment

REAR SUSPENSION

SHOCK ABSORBER

Nitro Gas - Performance	2002 - 2012	12749GR	2	\$143.75
-------------------------	-------------	----------------	---	----------

Nitro Gas - Performance	2012+	12731GR	2	\$143.75
-------------------------	-------	----------------	---	----------

• Check shock absorber specifications, some models can vary

LEAF SPRINGS

	Est. Lift	Additional Load			
Medium	40mm	0 - 200kg	MAH002B	2	\$352.84

U-BOLTS

U-Bolt Kit		1103UBK	2	\$39.21
------------	--	----------------	---	---------

POLYURETHANE SPRING BUSHES

Bush Kit		719UK	1	\$65.34
----------	--	--------------	---	---------

GREASABLE SHACKLES AND PINS

Greasable Shackle	Left side	353LH	1	\$65.34
-------------------	-----------	--------------	---	---------

Greasable Shackle	Right side	353RH	1	\$65.34
-------------------	------------	--------------	---	---------

Greasable Pin		1149	2	\$39.21
---------------	--	-------------	---	---------

HELPER SPRINGS

Load Plus Helper Springs		LP4	1	\$156.82
--------------------------	--	------------	---	----------

SUSPENSION KIT

Medium - Nitro Gas		MAH002BKG		\$1816.46
--------------------	--	------------------	--	-----------

• Check rear shock absorber part number

SUSPENSION KIT CONTENTS

Shock Absorbers

Torsion Bars

Polyurethane Spring Bushes

Leaf Springs

U-Bolts





Wagon
2002 to 2014

Mahindra Scorpio

PRODUCT DESCRIPTION

PART NO.

QTY
Required

RETAIL
ea Incl GST

SUSPENSION TO SUIT MAHINDRA SCORPIO

FRONT SUSPENSION

SHOCK ABSORBER

Nitro Gas - Performance

12087GR

2

\$143.75

TORSION BAR

Up-rated Torsion Bars

MAH001

1

\$392.04

• Minimum 60mm downward suspension travel required after adjustment

REAR SUSPENSION

SHOCK ABSORBER

Nitro Gas - Performance

12749GR

2

\$143.75

• Check shock absorber specifications, some models can vary

COIL SPRINGS

Medium

Est. Lift
40mm

Additional Load
0 - 200kg

MAH003B

1

\$248.30

SUSPENSION KIT

Medium - Nitro Gas

MAH003BKG

\$1215.33

SUSPENSION KIT CONTENTS

Shock Absorbers

Coil Springs





Unlock your adventure!

for a full range of accessories visit our website

www.ironman4x4.com



Mazda BT50

6/2020+

PRODUCT DESCRIPTION

DATE AVAILABLE

PART NO.

QTY
RequiredRETAIL
ea Incl GST

ACCESSORIES TO SUIT MAZDA BT50

STEEL WINCH BULL BARS

Commercial Deluxe	Q2 2021	BBCD080	\$2021.00
Proguard No Loop	Q2 2021	BBT080-NL	\$1670.00
Proguard Single Loop Kit	Q2 2021	BB080-SL	\$297.00
Proguard Triple Loop Kit	Q2 2021	BB080-TL	\$357.00
Driving Light Patch Loom - Factory LED Headlight models only		IPL074	\$30.00

STEEL SIDE STEPS AND RAILS

Side Steps	Q2 2021	SS080	\$848.00
Side Rails	Q2 2021	SS080 RAIL	\$280.00
Side Steps and Rails	Q2 2021	SSR080	\$1022.00

TOWING

Rear Protection Towbar	Q2 2021	RTB080	\$1196.00
Towbar Wiring Loom - Plug and Play		ITBL041	\$139.00

LOCKSAFE DRAWER SYSTEMS

Twin Drawers - 1300mm		ITD1300	\$1469.00
Single Drawer - 1300mm		ISD1300	\$891.00
Wing Kit - 1300mm*	Q2 2021	ITDW074	\$352.00

*Designed to suit factory tubs, will not suit ute liner without modification

PREMIUM UNDERBODY PROTECTION

Engine Bay and Transmission - Electric Steering Model	Q2 2021	UBP074S	\$712.00
Engine Bay and Transmission - Non-Electric Steering Model		UBP074	\$712.00

CANOPY - ABS PLASTIC (SIDE LIFT UP WINDOWS AND CENTRAL LOCKING REAR DOOR) - FITS 4X4 AND 4X2 DUAL CAB MODELS

Pre-Primed		CANOPY022-P	\$3143.00*
Colour Coded		CANOPY022-W	\$3743.00
ABS Canopy Rack Feet		IRRFEETABS14	\$250.00

• See Page 33 and 34 for 1.4m Roof Rack options and pricing.

* Pre-primed canopies, plus colour coding.

SEAT COVER

Canvas Comfort - Front	Q2 2021	ICSC074F	\$400.00
Canvas Comfort - Rear	Q2 2021	ICSC074R	\$400.00

DIFF BREATHER KIT

Diff Breather Kit		IDIFFBRE	\$114.00
-------------------	--	----------	----------

LISTING
CONTINUED
OVER THE
PAGE



PRODUCT DESCRIPTION

DATE AVAILABLE

PART NO.

QTY
Required

RETAIL
ea Incl GST

SUSPENSION TO SUIT MAZDA BT50

FRONT SUSPENSION

SHOCK ABSORBER

Nitro Gas Strut - Performance			12845GR	2	\$209.09
Foam Cell Strut - Performance			24845FE	2	\$235.23
Foam Cell Pro Strut - Performance			45845FE	2	\$365.91

• Height adjustable with Ironman 4x4 Strut Trim Packers

COIL SPRINGS

	Est. Lift	Additional Load			
Standard	0mm	0 - 50kg	HOLD020S	1	\$235.23
Light	30mm	0 - 50kg	HOLD020A	1	\$235.23
Medium	40mm	0 - 50kg	HOLD020B	1	\$235.23
Heavy	40mm	50 - 110kg	HOLD020C	1	\$235.23

STRUT MOUNTS

Steel Strut Top			ISST017	2	\$78.41
-----------------	--	--	----------------	---	---------

CONTROL ARMS

Pro-Forge Upper Control Arms	Q2 2021		UCA074FA	1	\$831.60
------------------------------	----------------	--	-----------------	---	----------

TRIM PACKERS

5mm Strut Trim Packer	Nitro Gas / Foam Cell	HILFR05 / HILFR05F	2	\$26.14
10mm Strut Trim Packer	Nitro Gas / Foam Cell	HILFR10 / HILFR10F	2	\$26.14
15mm Strut Trim Packer	Nitro Gas / Foam Cell	HILFR15 / HILFR15F	2	\$26.14

• ONLY Compatible with Ironman 4x4 Struts (except Pro), lift height subject to 2:1 motion ratio. Unnecessary fitment may lift vehicle too high

REAR SUSPENSION

SHOCK ABSORBER

Nitro Gas - Comfort			12698GRC	2	\$143.75
Nitro Gas - Performance			12698GR	2	\$143.75
Nitro Gas - Professional			12698GRP	2	\$143.75
Foam Cell - Comfort			24698FEC	2	\$209.09
Foam Cell - Performance			24698FE	2	\$209.09
Foam Cell - Professional			24698FEP	2	\$209.09
Foam Cell Pro - Comfort			45698FEC	2	\$287.50
Foam Cell Pro - Performance			45698FE	2	\$287.50
Foam Cell Pro - Professional			45698FEP	2	\$287.50

LEAF SPRINGS

	Est. Lift	Additional Load			
Light	30mm	0 - 200kg	HOLD021A	2	\$378.98
Medium	45mm	0 - 300kg	HOLD021B	2	\$378.98
Heavy	45mm	300kg - 600kg	HOLD021C	2	\$392.04
Extra Heavy	45mm	600kg - GVM	HOLD021D	2	\$392.04

U-BOLTS

U-Bolt Kit			437UBKL	2	\$39.21
U-Bolt Kit	Suits HOLD021D		678UBK	2	\$39.21

POLYURETHANE SPRING BUSHES

Bush Kit			770UK	1	\$156.82
----------	--	--	--------------	---	----------

SPACER KIT

Brake Hose Relocation Kit			1152K	1	\$13.07
---------------------------	--	--	--------------	---	---------

GREASABLE SHACKLES AND PINS

Greasable Shackle			1156	2	\$52.28
Non-Greasable Pin			387-1	2	\$26.14

HELPER SPRINGS

Add-A-Leaf			ISL6010	1	\$156.82
------------	--	--	----------------	---	----------



6/2020+

Mazda BT50

PRODUCT DESCRIPTION

PART NO.

QTY
Required

RETAIL
ea Incl GST

SUSPENSION KIT

Light - Nitro Gas	HOLD021AKG3	\$1947.14
Light - Foam Cell	HOLD021AKF3	\$2130.09
Light - Foam Cell Pro	HOLD021AKP3	\$2548.26
Medium - Nitro Gas	HOLD021BKG3	\$1947.14
Medium - Foam Cell	HOLD021BKF3	\$2130.09
Medium - Foam Cell Pro	HOLD021BKP3	\$2548.26
Heavy - Nitro Gas	HOLD021CKG3	\$1973.27
Heavy - Foam Cell	HOLD021CKF3	\$2156.22
Heavy - Foam Cell Pro	HOLD021CKP3	\$2574.40
Extra Heavy - Nitro Gas	HOLD021DKG3	\$1973.27
Extra Heavy - Foam Cell	HOLD021DKF3	\$2156.22
Extra Heavy - Foam Cell Pro	HOLD021DKP3	\$2574.40

• Specify front Coil Springs when ordering

SUSPENSION KIT CONTENTS

Shock Absorbers	Coil Springs	Polyurethane Spring Bushes	Brake Hose Relocation Kit
Strut Shock Absorbers	Leaf Springs	U-Bolts	



OPTIONS AVAILABLE FOR THIS VEHICLE - SEE PAGE 369

Mazda BT50

2012 to 5/2020
Includes 5/2018 (Facelift)

PRODUCT DESCRIPTION

PART NO.

QTY
RequiredRETAIL
ea Incl GST

ACCESSORIES TO SUIT MAZDA BT50

STEEL WINCH BULL BARS

Commercial	BBC039	\$1569.00
Commercial Deluxe	BBOD039	\$1985.00
Proguard No Loop	BBT039-NL	\$1641.00
Proguard Single Loop Kit	BB039-SL	\$297.00
Proguard Triple Loop Kit	BB039-TL	\$357.00

• Can also be fitted to both 2WD and 4WD models. Note: Can use BB054-SL

STEEL SIDE STEPS AND RAILS - FITS DUAL CAB MODELS ONLY

Side Steps	SS039	\$848.00
Side Steps Rails	SSR039	\$1022.00

TOWING

Class 4 Towbar - Compatible with Factory Rear Bumper	TB038	\$523.00
Rear Protection Towbar - Full Rear Bumper Replacement	RTB038	\$1196.00
Rear Protection Towbar Plates (Pair)	RTBPLATE001	\$131.00
Towbar Wiring Loom - Plug and Play	ITBLO39	\$329.00

RECOVERY POINTS - IRONMAN 4X4 BULL BAR ONLY

Recovery Points - 5000kg Rating (Pair)	IRP054	\$300.00
--	--------	----------

LOCKSAFE DRAWER SYSTEMS

Twin Drawers - 1300mm	ITD1300	\$1469.00
Single Drawer - 1300mm	ISD1300	\$891.00
Wing Kit - 1300mm*	ITDW037	\$351.00

*Designed to suit factory tubs, will not suit ute liner without modification.

BATTERY TRAY - DUAL CAB ONLY

Suits 12" Battery	IBTRAY054	\$191.00
-------------------	-----------	----------

EXHAUST SYSTEM

BigBore 3.2L Diesel - Does not suit DPF Model - <i>While Stocks Last</i>	IEXHAUST007	\$1300.00
3" Exhaust Upgrade 3.2L - DPF Back - <i>While Stocks Last</i>	IEX054	\$770.00
3" Exhaust Upgrade - DPF Back (2016-2020 only) - <i>While Stocks Last</i>	IEX039	\$770.00

LONG RANGE FUEL TANK

140L* - Fits 2.2L and 3.2L Diesel only	TANK007	\$1129.00
--	---------	-----------

* Usable volume may differ to the stated tank capacity

PREMIUM UNDERBODY PROTECTION

Engine Bay and Transmission	UBP054	\$712.00
Engine Bay and Transmission - DPF Models (Retains factory transmission plate)	UBP055	\$500.00

UNDERBODY PROTECTION

Engine Bay and Transmission	IUP014K	\$494.00
Fuel Tank	IUP014F	\$296.00

• Fuel tank protection plates are not compatible with long range fuel tanks.



Mazda BT50

2012 to 5/2020
Includes 5/2018 (Facelift)

PRODUCT DESCRIPTION

PART NO.

QTY
RequiredRETAIL
ea Incl GST**CANOPY - ABS PLASTIC (SIDE LIFT UP WINDOWS AND CENTRAL LOCKING REAR DOOR) - FITS 4X4 AND 4X2 DUAL CAB MODELS**

Pre-Primed	CANOPY010-P †	\$3143.00*
Cool White (WVA) (A2W)	CANOPY010-CW	\$3743.00
Aurora Blue (WVD) (39A)	CANOPY010-AB	\$3743.00
Highlight Silver (18G)	CANOPY010-S	\$3743.00
Winning Blue (WVV)	CANOPY010-WB	\$3743.00
Magnetic Grey (WVQ)	CANOPY010-M †	\$3743.00
True Red (SWH)	CANOPY010-TR	\$3743.00
Meteor Grey (42A) (SWT)	CANOPY010-G †	\$3743.00
Titanium Flash (42A)	CANOPY018-TF	\$3743.00
Frozen White (WVZ)	CANOPY010-FW †	\$3743.00
Metropolitan Grey (WVT) (36C)	CANOPY010-MG	\$3743.00
Aluminium Metallic (SWR) (38P)	CANOPY010-AM	\$3743.00
Ingot Silver (WVR)	CANOPY010-IS †	\$3743.00
Shadow Black (UO)	CANOPY010-SB †	\$3743.00
Blue Lightning (SW3)	CANOPY010-BL †	\$3743.00
Arctic White (SWU)	CANOPY010-AW †	\$3743.00
Jet Black Mica (41W)	CANOPY018-B	\$3743.00
ABS Canopy Rack Feet	IRRFETABS14	\$250.00

• Includes tub strengthening bracket (CANOPY010 BRACKET)

• Colour code and build date must be confirmed for Aluminium Metallic Canopies (CANOPY010-AM)

• See Page 33 and 34 for 1.4m Roof Rack options and pricing.

* Pre-primed canopies, plus colour coding. († With central locking)

CANOPY - SMOOTH FINISH FIBREGLASS PINNACLE (SIDE LIFT UP WINDOWS AND CENTRAL LOCKING REAR DOOR) - FITS 4X4 AND 4X2 DUAL CAB MODELS

Pre-Primed	CANFIBRE054-P	\$2783.00*
Frozen White (WVZ)	CANFIBRE054-FW	\$3297.00
Magnetic Grey (WVQ)	CANFIBRE054-M	\$3297.00
Winning Blue (WVV)	CANFIBRE054-WB	\$3297.00
Ingot Silver (WVR)	CANFIBRE054-IS	\$3297.00
Shadow Black (UO)	CANFIBRE054-SB	\$3297.00

* Pre-primed canopies, plus colour coding.

TUB STRENGTHENING BRACKET

To suit all Canopies - (Must be fitted)	CANOPY010 BRACKET	\$49.00
---	-------------------	---------

SEAT COVER

2012-2015 Canvas Comfort - Front	ICSC038F	\$400.00
2012-2015 Canvas Comfort - Rear	ICSC038R	\$400.00
2016+ Canvas Comfort - Front	ICSC054F	\$400.00
2016+ Canvas Comfort - Rear	ICSC055R	\$400.00

DIFF BREATHER KIT

Diff Breather Kit	IDIFFBRE	\$114.00
-------------------	----------	----------

LISTING
CONTINUED
OVER THE
PAGE



PRODUCT DESCRIPTION

PART NO.

QTY
Required

RETAIL
ea Incl GST

SUSPENSION TO SUIT MAZDA BT50

FRONT SUSPENSION

SHOCK ABSORBER

Nitro Gas Strut - Performance			12727GR	2	\$209.09
Foam Cell Strut - Performance			24727FE	2	\$235.23
Foam Cell Pro Strut - Performance			45727FE	2	\$365.91

• Height adjustable with Ironman 4x4 Strut Trim Packers

COIL SPRINGS

	Est. Lift	Additional Load			
Standard	0mm	0 - 50kg	FOR001S	1	\$235.23
Light	35mm	0 - 50kg	FOR001A	1	\$235.23
Medium	40mm	0 - 50kg	FOR001B	1	\$235.23
Heavy	45mm	50 - 110kg	FOR001C	1	\$235.23

STRUT MOUNTS

Steel Strut Top			ISST014	2	\$78.41
-----------------	--	--	----------------	---	---------

TRIM PACKERS

5mm Strut Trim Packer	Nitro Gas / Foam Cell	HILFR05 / HILFR05F	2	\$26.14
10mm Strut Trim Packer	Nitro Gas / Foam Cell	HILFR10 / HILFR10F	2	\$26.14
15mm Strut Trim Packer	Nitro Gas / Foam Cell	HILFR15 / HILFR15F	2	\$26.14

• ONLY Compatible with Ironman 4x4 Struts (except Pro), lift height subject to 2:1 motion ratio. Unnecessary fitment may lift vehicle too high

CONTROL ARMS

Pro-Forge Upper Control Arms			UCA054FA	1	\$831.60
------------------------------	--	--	-----------------	---	----------

SPACER KIT

Sway Bar Relocation Kit			1203K	1	\$91.48
-------------------------	--	--	--------------	---	---------

REAR SUSPENSION

SHOCK ABSORBER

Nitro Gas - Comfort			12095GRC	2	\$143.75
Nitro Gas - Performance			12095GR	2	\$143.75
Foam Cell - Comfort			24095FEC	2	\$209.09
Foam Cell - Performance			24095FE	2	\$209.09
Foam Cell - Professional			24095FEP	2	\$209.09
Foam Cell Pro - Comfort			45095FEC	2	\$287.50
Foam Cell Pro - Performance			45095FE	2	\$287.50
Foam Cell Pro - Professional			45095FEP	2	\$287.50

LEAF SPRINGS

	Est. Lift	Additional Load			
Light	40mm	0 - 200kg	FOR002A	2	\$352.84
Medium	45mm	0 - 300kg	FOR002B	2	\$352.84
Heavy	45mm	300kg - GVM	FOR002C	2	\$378.98

• Possible driveline vibration may occur due to increased ride height, use 1194K to reduce vibration to satisfactory level

U-BOLTS

U-Bolt Kit			417UBK	2	\$39.21
------------	--	--	---------------	---	---------

POLYURETHANE SPRING BUSHES

Bush Kit			1193UK	1	\$156.82
----------	--	--	---------------	---	----------

DRIVELINE SPACERS

Centre Bearing Spacer Kit			1194K	1	\$39.21
---------------------------	--	--	--------------	---	---------

GREASABLE SHACKLES AND PINS

Greasable Shackle			1147	2	\$52.28
Non-Greasable Pin			387-1	2	\$26.14

HELPER SPRINGS

Load Plus Helper Springs			LP3	1	\$156.82
Add-A-Leaf			ISL6010	1	\$156.82



2011 to 5/2020

SUSPENSION TO SUIT

Mazda BT50

PRODUCT DESCRIPTION

PART NO.

QTY
Required

RETAIL
ea Incl GST

SUSPENSION KIT

Light - Nitro Gas	FOR001AKG	\$1921.00
Light - Foam Cell	FOR001AKF	\$2103.95
Light - Foam Cell Pro	FOR001AKP	\$2522.13
Medium - Nitro Gas	FOR001BKG	\$1921.00
Medium - Foam Cell	FOR001BKF	\$2103.95
Medium - Foam Cell Pro	FOR001BKP	\$2522.13
Heavy - Nitro Gas	FOR001CKG	\$1973.27
Heavy - Foam Cell	FOR001CKF	\$2156.22
Heavy - Foam Cell Pro	FOR001CKP	\$2574.40

- Specify front Coil Springs when ordering
- Possible driveline vibration may occur due to increased ride height, use 1194K to reduce vibration to satisfactory level.

SUSPENSION KIT CONTENTS

Shock Absorbers	Coil Springs	Polyurethane Spring Bushes	Centre Bearing Spacer Kit
Strut Shock Absorbers	Leaf Springs	U-Bolts	





PRODUCT DESCRIPTION

PART NO.

QTY
RequiredRETAIL
ea Incl GST

ACCESSORIES TO SUIT MAZDA BT50

STEEL WINCH BULL BARS

Commercial - <i>While Stocks Last</i>	BBC024	\$1569.00
Commercial Deluxe	BBCD024	\$1985.00
Protector	BBT024	\$2009.00

• Can also be fitted to both 2WD and 4WD models.

STEEL SIDE STEPS AND RAILS - FITS DUAL CAB MODELS ONLY

Side Steps	SS009	\$851.00
Side Steps and Rails	SSR007	\$1022.00

LOCKSAFE DRAWER SYSTEMS

Twin Drawers - 1300mm	ITD1300	\$1469.00
Single Drawer - 1300mm	ISD1300	\$891.00

SNORKEL

3.0L TDi Diesel	ISNORKEL024	\$387.00
-----------------	-------------	----------

EXHAUST SYSTEM

BigBore BT50 (Automatic Transmission) - Diesel Only - <i>While Stocks Last</i>	IEEXHAUST014	\$1300.00
BigBore BT50 (Manual Transmission) - Diesel Only - <i>While Stocks Last</i>	IEEXHAUST015	\$1300.00

LONG RANGE FUEL TANK

122L* - Fits Dual and Single Cab only	TANK006	\$1129.00
---------------------------------------	---------	-----------

* Usable volume may differ to the stated tank capacity

UNDERBODY PROTECTION

Engine Bay and Transmission	IUP008K	\$437.00
-----------------------------	---------	----------

CANOPY - ABS PLASTIC (SIDE LIFT UP WINDOWS) - FITS 4X4 AND 4X2 DUAL CAB MODELS

Pre-Primed	CANOPY004-P	\$3143.00*
White (A2W)	CANOPY004-W	\$3743.00

* Pre-primed canopies, plus colour coding.

DIFF BREATHER KIT

Diff Breather Kit	IDIFFBRE	\$114.00
-------------------	----------	----------



Mazda BT50

2006 to 2011

PRODUCT DESCRIPTION

PART NO.

QTY
RequiredRETAIL
ea Incl GST

SUSPENSION TO SUIT MAZDA BT50

FRONT SUSPENSION

SHOCK ABSORBER

Nitro Gas - Performance		12667GR	2	\$143.75
Foam Cell - Performance		24667FE	2	\$209.09
Foam Cell Pro - Performance		45667FE	2	\$287.50

TORSION BAR

Uprated Torsion Bars	Duratorq Engine	MAZDA014	1	\$392.04
Uprated Torsion Bars	2.5L WLT Engine	MAZDA005	1	\$392.04

- MAZDA014 is 1024mm in length, used on most vehicles. Vehicles with 2.5L WLT Engine use MAZDA005 (924mm) Torsion Bar
- Minimum 60mm downward suspension travel required after adjustment

REAR SUSPENSION

SHOCK ABSORBER

Nitro Gas - Comfort		12095GRC	2	\$143.75
Nitro Gas - Performance		12095GR	2	\$143.75
Foam Cell - Comfort		24095FEC	2	\$209.09
Foam Cell - Performance		24095FE	2	\$209.09
Foam Cell - Professional		24095FEP	2	\$209.09
Foam Cell Pro - Comfort		45095FEC	2	\$287.50
Foam Cell Pro - Performance		45095FE	2	\$287.50
Foam Cell Pro - Professional		45095FEP	2	\$287.50

LEAF SPRINGS

	Est. Lift	Additional Load		
Light	40mm	0 - 100kg	MAZDA041A	\$352.84
Medium	40mm	0 - 200kg	MAZDA041B	\$352.84
Heavy	40mm	200 - 400kg	MAZDA041C	\$378.98
Extra Heavy	40mm	400kg - GVM	MAZDA041D	\$378.98

U-BOLTS

U-Bolt Kit	417UBK	2	\$39.21
------------	---------------	---	---------

POLYURETHANE SPRING BUSHES

Bush Kit	759UK	1	\$78.41
----------	--------------	---	---------

GREASABLE SHACKLES AND PINS

Greasable Shackle	386-1	2	\$52.28
-------------------	--------------	---	---------

HELPER SPRINGS

Load Plus Helper Springs	LP3	1	\$156.82
Add-A-Leaf	ISL6010	1	\$156.82

SUSPENSION KIT

Light - Nitro Gas	MAZDA041AKG	\$1829.52
Light - Foam Cell	MAZDA041AKF	\$2090.88
Light - Foam Cell Pro	MAZDA041AKP	\$2404.52
Medium - Nitro Gas	MAZDA041BKG	\$1829.52
Medium - Foam Cell	MAZDA041BKF	\$2090.88
Medium - Foam Cell Pro	MAZDA041BKP	\$2404.52
Heavy - Nitro Gas	MAZDA041CKG	\$1881.80
Heavy - Foam Cell	MAZDA041CKF	\$2143.16
Heavy - Foam Cell Pro	MAZDA041CKP	\$2456.79
Extra Heavy - Nitro Gas	MAZDA041DKG	\$1881.80
Extra Heavy - Foam Cell	MAZDA041DKF	\$2143.16
Extra Heavy - Foam Cell Pro	MAZDA041DKP	\$2456.79

- Check Torsion Bar length before ordering

SUSPENSION KIT CONTENTS

Shock Absorbers
Leaf SpringsTorsion Bars
U-Bolts

Polyurethane Spring Bushes



an adventure is worth sharing!



for a full range of accessories visit our website

www.ironman4x4.com



Mazda B Series

Bravo
1987 to 2006

PRODUCT DESCRIPTION

PART NO.

QTY
RequiredRETAIL
ea Incl GST

SUSPENSION TO SUIT MAZDA B SERIES

FRONT SUSPENSION

SHOCK ABSORBER

Nitro Gas - Performance	12667GR	2	\$143.75
Foam Cell - Performance	24667FE	2	\$209.09
Foam Cell Pro - Performance	45667FE	2	\$287.50

TORSION BAR

Uprated Torsion Bars	MAZDA005	1	\$392.04
----------------------	----------	---	----------

- Minimum 60mm downward suspension travel required after adjustment

REAR SUSPENSION

SHOCK ABSORBER

Nitro Gas - Comfort	12095GRC	2	\$143.75
Nitro Gas - Performance	12095GR	2	\$143.75
Foam Cell - Comfort	24095FEC	2	\$209.09
Foam Cell - Performance	24095FE	2	\$209.09
Foam Cell - Professional	24095FEP	2	\$209.09
Foam Cell Pro - Comfort	45095FEC	2	\$287.50
Foam Cell Pro - Performance	45095FE	2	\$287.50
Foam Cell Pro - Professional	45095FEP	2	\$287.50

LEAF SPRINGS

	Est. Lift	Additional Load			
Light	40mm	0 - 100kg	MAZDA006A	2	\$352.84
Medium	40mm	0 - 200kg	MAZDA006B	2	\$352.84
Heavy	40mm	200 - 400kg	MAZDA006C	2	\$352.84
Extra Heavy	40mm	400kg - GVM	MAZDA006D	2	\$378.98

U-BOLTS

U-Bolt Kit	415UBK	2	\$39.21
------------	--------	---	---------

POLYURETHANE SPRING BUSHES

Bush Kit	756UK	1	\$78.41
----------	-------	---	---------

GREASABLE SHACKLES AND PINS

Greasable Shackle	386-1	2	\$52.28
Greasable Pin	794	2	\$39.21

HELPER SPRINGS

Load Plus Helper Springs	LP3	1	\$156.82
Add-A-Leaf	ISL6010	1	\$156.82

SUSPENSION KIT

Light - Nitro Gas	MAZDA006AKG	\$1829.52
Light - Foam Cell	MAZDA006AKF	\$2090.88
Light - Foam Cell Pro	MAZDA006AKP	\$2404.52
Medium - Nitro Gas	MAZDA006BKG	\$1829.52
Medium - Foam Cell	MAZDA006BKF	\$2090.88
Medium - Foam Cell Pro	MAZDA006BKP	\$2404.52
Heavy - Nitro Gas	MAZDA006CKG	\$1829.52
Heavy - Foam Cell	MAZDA006CKF	\$2090.88
Heavy - Foam Cell Pro	MAZDA006CKP	\$2404.52
Extra Heavy - Nitro Gas	MAZDA006DKG	\$1881.80
Extra Heavy - Foam Cell	MAZDA006DKF	\$2143.16
Extra Heavy - Foam Cell Pro	MAZDA006DKP	\$2456.79

SUSPENSION KIT CONTENTS

Shock Absorbers
Leaf SpringsTorsion Bars
U-Bolts

Polyurethane Spring Bushes

Mercedes-Benz G-Wagen

W460, W461, W463
1979+



PRODUCT DESCRIPTION

PART NO.

QTY
Required

RETAIL
ea Incl GST

SUSPENSION TO SUIT MERCEDES-BENZ G-WAGEN

FRONT SUSPENSION

SHOCK ABSORBER

Nitro Gas - Performance			12811GR	2	\$143.75
Foam Cell - Performance			24811FE	2	\$209.09

COIL SPRINGS

	Est. Lift	Additional Load			
Medium	45mm	0 - 50kg	MERC020B	1	\$254.10

REAR SUSPENSION

SHOCK ABSORBER

Nitro Gas - Performance			12812GR	2	\$143.75
Foam Cell - Performance			24812FE	2	\$209.09

COIL SPRINGS

	Est. Lift	Additional Load			
Medium	45mm	0 - 300kg	MERC021B	1	\$254.10

SUSPENSION KIT

Medium - Nitro Gas	MERC021BKG	\$1123.85
Medium - Foam Cell	MERC021BKF	\$1385.21

SUSPENSION KIT CONTENTS

Shock Absorbers Coil Springs



G55 AMG

Mercedes-Benz G-Wagen

PRODUCT DESCRIPTION

PART NO.

QTY
Required

RETAIL
ea Incl GST

SUSPENSION TO SUIT MERCEDES-BENZ G-WAGEN

FRONT SUSPENSION

SHOCK ABSORBER

Foam Cell - Performance

24788FE

2

\$209.09

COIL SPRINGS

Est. Lift

Additional Load

Medium

45mm

0 - 50kg

MERC015B

1

\$274.43

REAR SUSPENSION

SHOCK ABSORBER

Foam Cell - Performance

24789FE

2

\$209.09

COIL SPRINGS

Est. Lift

Additional Load

Medium

45mm

0 - 300kg

MERC016B

1

\$274.43

SUSPENSION KIT

Medium - Foam Cell

MERC015BKF

\$1385.21

SUSPENSION KIT CONTENTS

Shock Absorbers

Coil Springs



Mercedes-Benz Unimog

UL1700, 2450, U5000
1300, 1550, U4000



PRODUCT DESCRIPTION

PART NO.

QTY
Required

RETAIL
ea Incl GST

SUSPENSION TO SUIT MERCEDES-BENZ UNIMOG

FRONT SUSPENSION

SHOCK ABSORBER

Foam Cell Pro - Performance	10 Bolt Axle Models	45802FE	2	\$287.50
Foam Cell Pro - Performance	6 Bolt Axle Models	45803FE	2	\$287.50

REAR SUSPENSION

SHOCK ABSORBER

Foam Cell Pro - Performance	10 Bolt Axle Models	45802FE	2	\$287.50
Foam Cell Pro - Performance	6 Bolt Axle Models	45803FE	2	\$287.50





4 Cyl Models
2017 to 5/2020

SUSPENSION TO SUIT

Mercedes-Benz X-Class

PRODUCT DESCRIPTION

PART NO.

QTY
Required

RETAIL
ea Incl GST

SUSPENSION TO SUIT MERCEDES-BENZ X-CLASS

FRONT SUSPENSION

SHOCK ABSORBER

Nitro Gas Strut - Performance			12716GR	2	\$209.09
Foam Cell Strut - Performance			24716FE	2	\$235.23
Foam Cell Pro Strut - Performance			45716FE	2	\$365.91

- Foam Cell Pro contains a single adjusting ring for driveshaft clearance
- Height adjustable with Ironman 4x4 Strut Trim Packers

COIL SPRINGS

	Est. Lift	Additional Load			
Standard Height	0mm	0 - 50kg	NISS040A	1	\$235.23
Light	20mm	0 - 50kg	NISS040B	1	\$235.23
Medium	35mm	0 - 80kg	NISS040C	1	\$235.41
Heavy	40mm	50 - 110kg	NISS040D	1	\$235.23

STRUT MOUNTS

Steel Strut Top			ISST007	2	\$78.41
-----------------	--	--	----------------	---	---------

TRIM PACKERS

5mm Strut Trim Packer	Nitro Gas / Foam Cell	HILFR05 / HILFR05F	2	\$26.14
10mm Strut Trim Packer	Nitro Gas / Foam Cell	HILFR10 / HILFR10F	2	\$26.14
15mm Strut Trim Packer	Nitro Gas / Foam Cell	HILFR15 / HILFR15F	2	\$26.14

- ONLY Compatible with Ironman 4x4 Struts (except Pro), lift height subject to 2:1 motion ratio. Unnecessary fitment may lift vehicle too high

REAR SUSPENSION

SHOCK ABSORBER

Nitro Gas - Performance			12728GR	2	\$143.75
Foam Cell - Performance			24728FE	2	\$209.09
Foam Cell - Professional			24728FEP	2	\$209.09
Foam Cell Pro - Comfort			45728FEC	2	\$287.50
Foam Cell Pro - Performance			45728FE	2	\$287.50
Foam Cell Pro - Professional			45728FEP	2	\$287.50

COIL SPRINGS

	Est. Lift	Additional Load			
Light	20mm	0 - 200kg	NISS058A	1	\$235.23
Medium	40mm	0 - 300kg	NISS058B	1	\$235.23
Heavy	40mm	300kg - 600kg	NISS058C	1	\$235.23
Extra Heavy	45mm	600kg - GVM	NISS058D	1	\$235.23

COIL SPACER

Polyurethane 20mm			NAVR20	2	\$39.21
-------------------	--	--	---------------	---	---------

SPACER KIT

Sway Bar and Headlight Bracket Extension Kit			1204K	1	\$91.48
--	--	--	--------------	---	---------

SUSPENSION KIT

Medium - Nitro Gas	NISS058BKG	\$1267.60
Medium - Foam Cell	NISS058BKF	\$1450.55
Medium - Foam Cell Pro	NISS058BKP	\$1868.73
Heavy - Nitro Gas	NISS058CKG	\$1267.60
Heavy - Foam Cell	NISS058CKF	\$1450.55
Heavy - Foam Cell Pro	NISS058CKP	\$1868.73
Extra Heavy - Nitro Gas	NISS058DKG	\$1267.60
Extra Heavy - Foam Cell	NISS058DKF	\$1450.55
Extra Heavy - Foam Cell Pro	NISS058DKP	\$1868.73

- Specify front Coil Springs when ordering

SUSPENSION KIT CONTENTS

Shock Absorbers	Coil Springs
Strut Shock Absorbers	Sway Bar and Headlight Bracket Kit



Mitsubishi Pajero Sport

7/2019+



PRODUCT DESCRIPTION

DATE AVAILABLE

PART NO.

QTY
Required

RETAIL
ea Incl GST

ACCESSORIES TO SUIT MITSUBISHI PAJERO SPORT

STEEL WINCH BULL BARS

Commercial Deluxe	Q2 2021	BBCD079	\$2021.00
Proguard No Loop	Q2 2021	BBT079-NL	\$1670.00
Proguard Single Loop Kit	Q2 2021	BB079-SL	\$297.00
Proguard Triple Loop Kit	Q2 2021	BB079-TL	\$357.00

STEEL SIDE STEPS AND RAILS

Side Steps	Q3 2021	SS079	\$848.00
------------	---------	-------	----------

RECOVERY POINTS - IRONMAN 4X4 BULL BAR ONLY

Recovery Points - 5000kg Rating (Pair)		IRP059	\$300.00
--	--	--------	----------

PREMIUM UNDERBODY PROTECTION

Engine Bay and Transmission		UBP050	\$712.00
-----------------------------	--	--------	----------

SEAT COVER

Front		ICSC059F	\$400.00
Rear		ICSC059R	\$400.00

DIFF BREATHER KIT

Diff Breather Kit		IDIFFBRE	\$114.00
-------------------	--	----------	----------





7/2019+

Mitsubishi Pajero Sport

PRODUCT DESCRIPTION

PART NO.

QTY
Required

RETAIL
ea Incl GST

SUSPENSION TO SUIT MITSUBISHI PAJERO SPORT

FRONT SUSPENSION

SHOCK ABSORBER

Nitro Gas Strut - Performance ¹			12715GR	2	\$209.09
Foam Cell Strut - Performance ¹			24715FE	2	\$235.23
Foam Cell Pro Strut - Performance* (SEE NOTE)			45715FE	2	\$365.91

*NOTE: MANDATORY FITMENT of UCA050FA and MITS045B /C Coil Springs with 45715FE

¹ Height adjustable with Ironman 4x4 Strut Trim Packers

COIL SPRINGS

	Est. Lift	Additional Load			
Medium	15mm	0 - 50kg	MITSO40B	1	\$235.23
Medium* (SEE NOTE)	50mm	0 - 50kg	MITSO45B *	1	\$235.22
Heavy	30mm	50 - 110kg	MITSO40C	1	\$235.23
Heavy* (SEE NOTE)	50mm	50 - 110kg	MITSO45C *	1	\$235.22

*NOTE: MANDATORY FITMENT of UCA050FA and 45715FE with (MITSO45B /C) Coil Springs

STRUT MOUNTS

Steel Strut Top			ISST010	2	\$91.48
-----------------	--	--	----------------	---	---------

TRIM PACKERS

5mm Strut Trim Packer	Nitro Gas / Foam Cell	HILFR05 / HILFR05F	2	\$26.14
10mm Strut Trim Packer	Nitro Gas / Foam Cell	HILFR10 / HILFR10F	2	\$26.14
15mm Strut Trim Packer	Nitro Gas / Foam Cell	HILFR15 / HILFR15F	2	\$26.14

• ONLY Compatible with Ironman 4x4 Struts, lift height subject to 2:1 motion ratio. Unnecessary fitment may lift vehicle too high

CONTROL ARMS

Pro-Forge Upper Control Arms			UCA050FA	1	\$831.60
------------------------------	--	--	-----------------	---	----------

REAR SUSPENSION

SHOCK ABSORBER

Nitro Gas - Performance			12645GRS	2	\$143.75
Foam Cell - Performance			24645FES	2	\$209.09

COIL SPRINGS

	Est. Lift	Additional Load			
Light	15mm	0 - 200kg	MITSO42A	1	\$235.23
Medium	30mm	0 - 250kg	MITSO42B	1	\$235.23
Medium - with Accessories	40mm	250-500kg	MITSO20B	1	\$235.23
Heavy	40mm	300kg - GVM	MITSO42C	1	\$235.23

• Check LHS rear coil captivity when lowering to ground

SUSPENSION KIT

Medium - Nitro Gas	MITSO42BKG1	\$1176.12
Medium - Foam Cell	MITSO42BKF1	\$1359.08
Heavy - Nitro Gas	MITSO42CKG1	\$1176.12
Heavy - Foam Cell	MITSO42CKF1	\$1359.08

• Specify Front Coil Springs when ordering

• Please note limited lift height, due to restrictions in vehicle design.

SUSPENSION KIT CONTENTS

Shock Absorbers

Strut Shock Absorbers

Coil Springs

Mitsubishi Pajero Sport

11/2016 to 6/2019



PRODUCT DESCRIPTION

PART NO.

QTY
Required

RETAIL
ea Incl GST

ACCESSORIES TO SUIT MITSUBISHI PAJERO SPORT

STEEL WINCH BULL BARS

Commercial Deluxe* - Suits GLX and GLS	BBCD059	\$2021.00
Exceed Kit - Required for Exceed model	BB059-EXCEED KIT	\$119.00
Proguard No Loop	BBT059-NL	\$1670.00
Proguard Single Loop Kit	BB059-SL	\$297.00
Proguard Triple Loop Kit	BB059-TL	\$357.00

* Winch with Steel Cable and Roller Fairlead is not suitable - Use Winch with Synthetic Rope and Alloy Hawse only

* Do not fit winch control box in front of Mitsubishi Badge for vehicles with Radar.

STEEL SIDE STEPS AND RAILS - BODY MOUNT ONLY DUE TO ELECTRIC HANDBRAKE

Side Steps	SS059	\$851.00
------------	-------	----------

RECOVERY POINTS - IRONMAN 4X4 BULL BAR ONLY

Recovery Points - 5000kg Rating (Pair)	IRP059	\$300.00
--	--------	----------

SEAT COVER

Canvas Comfort - Front	ICSC059F	\$400.00
Canvas Comfort - Rear	ICSC059R	\$400.00

DIFF BREATHER KIT

Diff Breather Kit	IDIFFBRE	\$114.00
-------------------	----------	----------





2.4L Mivec
2015 to 6/2019

Mitsubishi Pajero Sport

PRODUCT DESCRIPTION

PART NO.

QTY
Required

RETAIL
ea Incl GST

SUSPENSION TO SUIT MITSUBISHI PAJERO SPORT

FRONT SUSPENSION

SHOCK ABSORBER

Nitro Gas Strut - Performance ¹			12715GR	2	\$209.09
Foam Cell Strut - Performance ¹			24715FE	2	\$235.23
Foam Cell Pro Strut - Performance* (SEE NOTE)			45715FE	2	\$365.91

*NOTE: MANDATORY FITMENT of UCA050FA and MITS045B /C Coil Springs with 45715FE

¹ Height adjustable with Ironman 4x4 Strut Trim Packers

COIL SPRINGS

	Est. Lift	Additional Load			
Medium	15mm	0 - 50kg	MITSO40B	1	\$235.23
Medium* (SEE NOTE)	50mm	0 - 50kg	MITSO45B *	1	\$235.22
Heavy	30mm	50 - 110kg	MITSO40C	1	\$235.23
Heavy* (SEE NOTE)	50mm	50 - 110kg	MITSO45C *	1	\$235.22

*NOTE: MANDATORY FITMENT of UCA050FA and 45715FE with (MITSO45B /C) Coil Springs

STRUT MOUNTS

Steel Strut Top			ISST010	2	\$91.48
-----------------	--	--	----------------	---	---------

TRIM PACKERS

5mm Strut Trim Packer	Nitro Gas / Foam Cell	HILFR05 / HILFR05F	2	\$26.14
10mm Strut Trim Packer	Nitro Gas / Foam Cell	HILFR10 / HILFR10F	2	\$26.14
15mm Strut Trim Packer	Nitro Gas / Foam Cell	HILFR15 / HILFR15F	2	\$26.14

• ONLY Compatible with Ironman 4x4 Struts, lift height subject to 2:1 motion ratio. Unnecessary fitment may lift vehicle too high

CONTROL ARMS

Pro-Forge Upper Control Arms			UCA050FA	1	\$831.60
------------------------------	--	--	-----------------	---	----------

REAR SUSPENSION

SHOCK ABSORBER

Nitro Gas - Performance			12645GRS	2	\$143.75
Foam Cell - Performance			24645FES	2	\$209.09

COIL SPRINGS

	Est. Lift	Additional Load			
Light	15mm	0 - 200kg	MITSO42A	1	\$235.23
Medium	30mm	0 - 250kg	MITSO42B	1	\$235.23
Medium - with Accessories	40mm	250-500kg	MITSO20B	1	\$235.23
Heavy	40mm	300kg - GVM	MITSO42C	1	\$235.23

• Check LHS rear coil captivity when lowering to ground

SUSPENSION KIT

Medium - Nitro Gas	MITSO42BKG1	\$1176.12
Medium - Foam Cell	MITSO42BKF1	\$1359.08
Heavy - Nitro Gas	MITSO42CKG1	\$1176.12
Heavy - Foam Cell	MITSO42CKF1	\$1359.08

• Specify Front Coil Springs when ordering

• Please note limited lift height, due to restrictions in vehicle design.

SUSPENSION KIT CONTENTS

Shock Absorbers

Strut Shock Absorbers

Coil Springs

Mitsubishi Pajero

NW 2011 to NX



PRODUCT DESCRIPTION

PART NO.

QTY
Required

RETAIL
ea Incl GST

ACCESSORIES TO SUIT MITSUBISHI PAJERO

STEEL WINCH BULL BARS - NOT SUITABLE FOR VEHICLES WITH FACTORY FITTED HEADLIGHT WASHERS (DRL'S NOT COMPATIBLE)

Commercial - <i>While Stocks Last</i>	BBC045	\$1569.00
Commercial Deluxe	BBCD045	\$1985.00

UNDERBODY PROTECTION

Engine Bay and Transmission 2000+	IUP013K	\$624.00
-----------------------------------	----------------	----------

DIFF BREATHER KIT

Diff Breather Kit	IDIFFBRE	\$114.00
-------------------	-----------------	----------





NM, NP, NS, NT
5/2000 to 2011

Mitsubishi Pajero

PRODUCT DESCRIPTION

PART NO.

QTY
Required

RETAIL
ea Incl GST

ACCESSORIES TO SUIT MITSUBISHI PAJERO

STEEL WINCH BULL BARS - NOT SUITABLE FOR VEHICLES WITH FACTORY FITTED HEADLIGHT WASHERS (DRL'S NOT COMPATIBLE)

Commercial - Fits NS and NT models only - While Stocks Last

BBC045

\$1569.00

Commercial Deluxe - Fits NS and NT models only

BBCD045

\$1985.00

UNDERBODY PROTECTION

Engine Bay and Transmission 2000+

IUP013K

\$624.00

DIFF BREATHER KIT

Diff Breather Kit

IDIFFBRE

\$114.00

Mitsubishi Pajero

Montero NM-NX
2000+



PRODUCT DESCRIPTION

PART NO.

QTY
Required

RETAIL
ea Incl GST

SUSPENSION TO SUIT MITSUBISHI PAJERO

FRONT SUSPENSION

SHOCK ABSORBER

Nitro Gas Strut - Performance			12713GR	2	\$209.09
Foam Cell Strut - Performance			24713FE	2	\$235.23

COIL SPRINGS

	Est. Lift	Additional Load			
Medium	40mm	0 - 50kg	MITS038B	1	\$235.23
Heavy - Diesel	40mm	50 - 100kg	MITS038C	1	\$235.23

REAR SUSPENSION

SHOCK ABSORBER

Nitro Gas - Performance			12714GR	2	\$143.75
-------------------------	--	--	----------------	---	----------

COIL SPRINGS

	Est. Lift	Additional Load			
Medium - SWB	40mm	0 - 200kg	MITS039A	1	\$235.23
Medium - LWB	40mm	0 - 200kg	MITS039B	1	\$235.23
Heavy	40mm	200kg - GVM	MITS039C	1	\$235.23

SUSPENSION KIT

Medium - Nitro Gas	SWB		MITS038AKG		\$1176.12
Medium - Nitro Gas	LWB	Petrol	MITS038BKG		\$1176.12
Medium - Nitro Gas	LWB	Diesel	MITS038CKG		\$1176.12
Heavy - Nitro Gas	LWB	Petrol	MITS038CKG1		\$1176.12
Heavy - Nitro Gas	LWB	Diesel	MITS038CKG2		\$1176.12

- Vehicles with monocoque body construction can be subject to increased NVH (Noise) with upgraded suspension installed
- Vehicles with independent suspension must maintain a minimum of 60mm downward suspension travel
- Mandatory 4 wheel alignment after installing new suspension
- Specify front Coil Springs when ordering

SUSPENSION KIT CONTENTS

Shock Absorbers

Strut Shock Absorbers

Coil Springs





iO Pinin
1999+

Mitsubishi Pajero

PRODUCT DESCRIPTION

PART NO.

QTY
Required

RETAIL
ea Incl GST

SUSPENSION TO SUIT MITSUBISHI PAJERO

FRONT SUSPENSION

COIL SPRINGS	Est. Lift	Additional Load	PART NO.	QTY	RETAIL
Medium	35mm	0 - 50kg	MITSO34B	1	\$235.23
CAMBER CORRECTION					
Camber Bolt Kit			ICAMBER14	1	\$26.14

REAR SUSPENSION

COIL SPRINGS	Est. Lift	Additional Load	PART NO.	QTY	RETAIL
Medium	35mm	0 - 200kg	MITSO35B	1	\$235.23



PRODUCT DESCRIPTION

PART NO.

QTY
Required

RETAIL
ea Incl GST

SUSPENSION TO SUIT MITSUBISHI PAJERO

FRONT SUSPENSION

SHOCK ABSORBER

Nitro Gas - Performance		12087GR	2	\$143.75
Foam Cell - Performance		24087FE	2	\$209.09

TORSION BAR

Uprated Torsion Bars	1278mm Length	MITS013	1	\$392.04
Uprated Torsion Bars	1308mm Length	MITS019	1	\$392.04

- Check Torsion Bar length before ordering
- Minimum 60mm downward suspension travel required after adjustment

STEERING DAMPER

Foam Cell	Suits vehicles w/o power steering	3517	1	\$156.82
-----------	-----------------------------------	-------------	---	----------

REAR SUSPENSION

SHOCK ABSORBER

Nitro Gas - Performance		12646GR	2	\$143.75
Foam Cell - Performance		24646FE	2	\$209.09

COIL SPRINGS

	Est. Lift	Additional Load			
Medium - SWB	40mm	0 - 200kg	MITS022B	1	\$235.23
Medium - LWB	40mm	0 - 200kg	MITS020B	1	\$235.23
Heavy	40mm	200kg - GVM	MITS020C	1	\$235.23

SUSPENSION KIT

Medium - Nitro Gas	SWB	MITS022BKG2	\$1202.26
Medium - Nitro Gas	LWB	MITS020BKG2	\$1202.26
Medium - Foam Cell	SWB	MITS022BKF2	\$1463.62
Medium - Foam Cell	LWB	MITS020BKF2	\$1463.62
Heavy - Nitro Gas		MITS020CKG2	\$1202.26
Heavy - Foam Cell		MITS020CKF2	\$1463.62

- Check Torsion Bar length before ordering

SUSPENSION KIT CONTENTS

Shock Absorbers Coil Springs Torsion Bars



Montero NH-NL (Leaf)
1991 to 1999

SUSPENSION TO SUIT

Mitsubishi Pajero

PRODUCT DESCRIPTION

PART NO.

QTY
Required

RETAIL
ea Incl GST

SUSPENSION TO SUIT MITSUBISHI PAJERO

FRONT SUSPENSION

SHOCK ABSORBER

Nitro Gas - Performance		12087GR	2	\$143.75
Foam Cell - Performance		24087FE	2	\$209.09

TORSION BAR

Uprated Torsion Bars	1278mm Length	MITSO13	1	\$392.04
Uprated Torsion Bars	1308mm Length	MITSO19	1	\$392.04

- Check Torsion Bar length before ordering
- Minimum 60mm downward suspension travel required after adjustment

STEERING DAMPER

Foam Cell	Suits vehicles w/o power steering	3517	1	\$156.82
-----------	-----------------------------------	-------------	---	----------

REAR SUSPENSION

SHOCK ABSORBER

Nitro Gas - Comfort		12636GRC	2	\$143.75
Nitro Gas - Performance		12636GR	2	\$143.75
Nitro Gas - Professional		12636GRP	2	\$143.75
Foam Cell - Comfort		24636FEC	2	\$209.09
Foam Cell - Performance		24636FE	2	\$209.09
Foam Cell - Professional		24636FEP	2	\$209.09

LEAF SPRINGS

	Est. Lift	Additional Load			
Medium	40mm	0 - 300kg	MITSO18B	2	\$352.84
Heavy	40mm	300kg - GVM	MITSO18C	2	\$378.98

- Must use Ironman 4x4 bushes

U-BOLTS

U-Bolt Kit		451UBK	2	\$39.21
------------	--	---------------	---	---------

POLYURETHANE SPRING BUSHES

Bush Kit		715TUK	1	\$78.41
----------	--	---------------	---	---------

GREASABLE SHACKLES AND PINS

Greasable Shackle		795	2	\$52.28
Greasable Pin		796	2	\$26.14

HELPER SPRINGS

Load Plus Helper Springs		LP4	1	\$156.82
--------------------------	--	------------	---	----------

SUSPENSION KIT

Medium - Nitro Gas		MITSO18BKG2		\$1829.52
Medium - Foam Cell		MITSO18BKF2		\$2090.88
Heavy - Nitro Gas		MITSO18CKG2		\$1881.80
Heavy - Foam Cell		MITSO18CKF2		\$2143.16

- Check Torsion Bar length before ordering

SUSPENSION KIT CONTENTS

Shock Absorbers	Torsion Bars	Polyurethane Spring Bushes
Leaf Springs	U-Bolts	





PRODUCT DESCRIPTION

PART NO.

QTY
Required

RETAIL
ea Incl GST

SUSPENSION TO SUIT MITSUBISHI PAJERO

FRONT SUSPENSION

SHOCK ABSORBER

Nitro Gas - Performance		12082GR	2	\$143.75
Foam Cell - Performance		24082FE	2	\$209.09

TORSION BAR

Uprated Torsion Bars	1278mm Length	MITS013	1	\$392.04
Uprated Torsion Bars	1308mm Length	MITS019	1	\$392.04

- Check Torsion Bar length before ordering
- Minimum 60mm downward suspension travel required after adjustment

STEERING DAMPER

Foam Cell	Suits vehicles w/o power steering	3517	1	\$156.82
-----------	-----------------------------------	-------------	---	----------

REAR SUSPENSION

SHOCK ABSORBER

Nitro Gas - Comfort		12645GRC	2	\$143.75
Nitro Gas - Performance		12645GR	2	\$143.75
Foam Cell - Comfort		24645FEC	2	\$209.09
Foam Cell - Performance		24645FE	2	\$209.09

COIL SPRINGS

	Est. Lift	Additional Load			
Medium - SWB	40mm	0 - 200kg	MITS022B	1	\$235.23
Medium - LWB	40mm	0 - 200kg	MITS020B	1	\$235.23
Heavy	40mm	200kg - GVM	MITS020C	1	\$235.23

SUSPENSION KIT

Medium - Nitro Gas	SWB	MITS022BKG1	\$1202.26
Medium - Nitro Gas	LWB	MITS020BKG1	\$1202.26
Medium - Foam Cell	SWB	MITS022BKF1	\$1322.49
Medium - Foam Cell	LWB	MITS020BKF1	\$1463.62
Heavy - Nitro Gas		MITS020CKG1	\$1202.26
Heavy - Foam Cell		MITS020CKF1	\$1463.62

- Check Torsion Bar length before ordering

SUSPENSION KIT CONTENTS

Shock Absorbers Coil Springs



Montero NA-NG (Leaf)
Pre 1991

Mitsubishi Pajero

PRODUCT DESCRIPTION

PART NO.

QTY Required

RETAIL ea Incl GST

SUSPENSION TO SUIT MITSUBISHI PAJERO

FRONT SUSPENSION

SHOCK ABSORBER

Nitro Gas - Performance		12082GR	2	\$143.75
Foam Cell - Performance		24082FE	2	\$209.09

TORSION BAR

Uprated Torsion Bars	1278mm Length	MITSO13	1	\$392.04
Uprated Torsion Bars	1308mm Length	MITSO19	1	\$392.04

• Check Torsion Bar length before ordering

• Minimum 60mm downward suspension travel required after adjustment

STEERING DAMPER

Foam Cell	Suits vehicles w/o power steering	3517	1	\$156.82
-----------	-----------------------------------	-------------	---	----------

REAR SUSPENSION

SHOCK ABSORBER

Nitro Gas - Comfort		12636GRC	2	\$143.75
Nitro Gas - Performance		12636GR	2	\$143.75
Nitro Gas - Professional		12636GRP	2	\$143.75
Foam Cell - Comfort		24636FEC	2	\$209.09
Foam Cell - Performance		24636FE	2	\$209.09
Foam Cell - Professional		24636FEP	2	\$209.09

LEAF SPRINGS

	Est. Lift	Additional Load			
Medium	45mm	0 - 300kg	MITSO18B	2	\$352.84
Heavy	45mm	300kg - GVM	MITSO18C	2	\$378.98

• Must use Ironman 4x4 bushes

U-BOLTS

U-Bolt Kit		451UBK	2	\$39.21
------------	--	---------------	---	---------

POLYURETHANE SPRING BUSHES

Bush Kit		715UK	1	\$78.41
----------	--	--------------	---	---------

GREASABLE SHACKLES AND PINS

Greasable Shackle		795	2	\$52.28
Greasable Pin		796	2	\$26.14

HELPER SPRINGS

Load Plus Helper Springs		LP4	1	\$156.82
--------------------------	--	------------	---	----------

SUSPENSION KIT

Medium - Nitro Gas		MITSO18BKG1		\$1829.52
Medium - Foam Cell		MITSO18BKF1		\$2090.88
Heavy - Nitro Gas		MITSO18CKG1		\$1881.80
Heavy - Foam Cell		MITSO18CKF1		\$2143.16

• Check Torsion Bar length before ordering

SUSPENSION KIT CONTENTS

Shock Absorbers
Leaf Springs

Torsion Bars
U-Bolts

Polyurethane Spring Bushes



PRODUCT DESCRIPTION

PART NO.

QTY
Required

RETAIL
ea Incl GST

SUSPENSION TO SUIT MITSUBISHI PAJERO

FRONT SUSPENSION

SHOCK ABSORBER

Nitro Gas Strut - Performance			12715GR	2	\$209.09
Foam Cell Strut - Performance			24715FE	2	\$235.23

• Height adjustable with Ironman 4x4 Strut Trim Packers

COIL SPRINGS

	Est. Lift	Additional Load			
Standard Height	0mm	0 - 50kg	MITS040S	1	\$235.23
Light	35mm	0 - 50kg	MITS040A	1	\$235.23
Medium	40mm	0 - 80kg	MITS040B	1	\$235.23
Heavy	40mm	80 - 110kg	MITS040C	1	\$235.23

STRUT MOUNTS

Steel Strut Top			ISST010	2	\$91.48
-----------------	--	--	----------------	---	---------

TRIM PACKERS

5mm Strut Trim Packer	Nitro Gas / Foam Cell	HILFR05 / HILFR05F	2	\$26.14
10mm Strut Trim Packer	Nitro Gas / Foam Cell	HILFR10 / HILFR10F	2	\$26.14
15mm Strut Trim Packer	Nitro Gas / Foam Cell	HILFR15 / HILFR15F	2	\$26.14

• ONLY Compatible with Ironman 4x4 Struts (except Pro), lift height subject to 2:1 motion ratio. Unnecessary fitment may lift vehicle too high

REAR SUSPENSION

SHOCK ABSORBER

Nitro Gas - Performance			12645GRS	2	\$143.75
Foam Cell - Performance			24645FES	2	\$209.09

COIL SPRINGS

	Est. Lift	Additional Load			
Standard	0mm	0 - 250kg	MITS042S	1	\$235.23
Light	20mm	0 - 250kg	MITS042A	1	\$235.23
Medium	40mm	0 - 250kg	MITS042B	1	\$235.23
Heavy	40mm	250kg - GVM	MITS042C	1	\$235.23

SUSPENSION KIT

Standard - Nitro Gas	MITS042SKG	\$1176.12
Standard - Foam Cell	MITS042SKF	\$1359.08
Light - Nitro Gas	MITS042AKG	\$1176.12
Light - Foam Cell	MITS042AKF	\$1359.08
Medium - Nitro Gas	MITS042BKG	\$1176.12
Medium - Foam Cell	MITS042BKF	\$1359.08
Heavy - Nitro Gas	MITS042CKG	\$1176.12
Heavy - Foam Cell	MITS042CKF	\$1359.08

• Specify Front Coil Springs when ordering

SUSPENSION KIT CONTENTS

Shock Absorbers	Coil Springs
Strut Shock Absorbers	





Challenger / Montero Sport PA (Coil)
1998 to 2008

Mitsubishi Pajero

PRODUCT DESCRIPTION

PART NO.

QTY
Required

RETAIL
ea Incl GST

SUSPENSION TO SUIT MITSUBISHI PAJERO

FRONT SUSPENSION

SHOCK ABSORBER

Nitro Gas - Performance	12087GR	2	\$143.75
Foam Cell - Performance	24087FE	2	\$209.09

TORSION BAR

Uprated Torsion Bars	MITSO19	1	\$392.04
----------------------	----------------	---	----------

• Minimum 60mm downward suspension travel required after adjustment

REAR SUSPENSION

SHOCK ABSORBER

Nitro Gas - Comfort	12645GRC	2	\$143.75
Nitro Gas - Performance	12645GR	2	\$143.75
Foam Cell - Comfort	24645FEC	2	\$209.09
Foam Cell - Performance	24645FE	2	\$209.09

COIL SPRINGS

	Est. Lift	Additional Load			
Medium	40mm	0 - 200kg	MITSO22B	1	\$235.23
Heavy	40mm	200-400kg	MITSO20B	1	\$235.23
Extra Heavy	40mm	400kg - GVM	MITSO20C	1	\$235.23

SUSPENSION KIT

Medium - Nitro Gas	MITSO22BKG	\$1202.26
Medium - Foam Cell	MITSO22BKF	\$1463.62
Heavy - Nitro Gas	MITSO20BKG	\$1202.26
Heavy - Foam Cell	MITSO20BKF	\$1463.62
Extra Heavy - Nitro Gas	MITSO20CKG	\$1202.26
Extra Heavy - Foam Cell	MITSO20CKF	\$1463.62

SUSPENSION KIT CONTENTS

Shock Absorbers	Torsion Bars	Polyurethane Spring Bushes
Leaf Springs	U-Bolts	



Mitsubishi Pajero

Montero Sport (Leaf)
1998 to 2006



PRODUCT DESCRIPTION

PART NO.

QTY
Required

RETAIL
ea Incl GST

SUSPENSION TO SUIT MITSUBISHI PAJERO

FRONT SUSPENSION

SHOCK ABSORBER

Nitro Gas - Performance	12087GR	2	\$143.75
Foam Cell - Performance	24087FE	2	\$209.09

TORSION BAR

Uprated Torsion Bars	MITSO19	1	\$392.04
----------------------	----------------	---	----------

• Minimum 60mm downward suspension travel required after adjustment

REAR SUSPENSION

SHOCK ABSORBER

Nitro Gas - Comfort	12636GRC	2	\$143.75
Nitro Gas - Performance	12636GR	2	\$143.75
Nitro Gas - Professional	12636GRP	2	\$143.75
Foam Cell - Comfort	24636FEC	2	\$209.09
Foam Cell - Performance	24636FE	2	\$209.09
Foam Cell - Professional	24636FEP	2	\$209.09

LEAF SPRINGS

	Est. Lift	Additional Load			
Medium	40mm	0 - 300kg	MITSO18B	2	\$352.84
Heavy	40mm	300kg - GVM	MITSO18C	2	\$378.98

• Must use Ironman 4x4 bushes

U-BOLTS

U-Bolt Kit	451UBK	2	\$39.21
------------	---------------	---	---------

POLYURETHANE SPRING BUSHES

Bush Kit	715STUK	1	\$78.41
----------	----------------	---	---------

• Not compatible with OEM springs

GREASABLE SHACKLES AND PINS

Greasable Shackle	795	2	\$52.28
Greasable Pin	796	2	\$26.14

HELPER SPRINGS

Load Plus Helper Springs	LP4	1	\$156.82
--------------------------	------------	---	----------

SUSPENSION KIT

Medium - Nitro Gas	MITSO18BKG	\$1829.52
Medium - Foam Cell	MITSO18BKF	\$2090.88
Heavy - Nitro Gas	MITSO18CKG	\$1881.80
Heavy - Foam Cell	MITSO18CKF	\$2143.16

SUSPENSION KIT CONTENTS

Shock Absorbers

Coil Springs

Torsion Bars



L400
1994+

Mitsubishi Delica

PRODUCT DESCRIPTION

PART NO.

QTY
RequiredRETAIL
ea Incl GST

SUSPENSION TO SUIT MITSUBISHI DELICA

FRONT SUSPENSION

SHOCK ABSORBER

Nitro Gas - Performance		12667GR	2	\$143.75
Foam Cell - Performance		24667FE	2	\$209.09

TORSION BAR

Uprated Torsion Bars		MITSO31	1	\$392.04
----------------------	--	----------------	---	----------

- Torsion Bars suit vehicles 5/1994-5/1999 only

- Minimum 60mm downward suspension travel required after adjustment

REAR SUSPENSION

SHOCK ABSORBER

Nitro Gas - Performance	Without ECS	12698GR	2	\$143.75
Nitro Gas - Performance	With ECS	12671GR	2	\$143.75

- ECS - Electronic Control Suspension

COIL SPRINGS

	Est. Lift	Additional Load		
Medium	40mm	0 - 250kg	MITSO25B	1

SUSPENSION KIT

Medium - Nitro Gas	Without ECS	MITSO31BKG		\$1202.26
Medium - Nitro Gas	With ECS	MITSO31BKG1		\$1202.26

- Shock Absorbers do not re-connect to ECS system

SUSPENSION KIT CONTENTS

Shock Absorbers

Coil Springs

Torsion Bars



PRODUCT DESCRIPTION

PART NO.

QTY
RequiredRETAIL
ea Incl GST

ACCESSORIES TO SUIT MITSUBISHI TRITON

STEEL WINCH BULL BARS (INCLUDING GLS PREMIUM)

Commercial Deluxe	BBBCD067	\$2021.00
Proguard No Loop	BBT067-NL	\$1670.00
Proguard Single Loop Kit	BB067-SL	\$297.00
Proguard Triple Loop Kit	BB067-TL	\$357.00
Driving Light Patch Loom - Factory LED Headlight models only	IPL067	\$30.00
Load Resistor Kit with Mounting Brackets for Indicator / Parker Replacement	LR12V21W	\$49.00

• Winch with Steel Cable and Roller Fairlead is not suitable - Use Winch with Synthetic Rope and Alloy Hawse only

STEEL SIDE STEPS AND RAILS - FITS DUAL AND CLUB CAB

Side Steps	SS050	\$851.00
Side Rails	SS050 RAIL	\$280.00
Side Steps and Rails	SSR050	\$1022.00

TOWING (GLS MODEL ONLY)

Class 4 Towbar - Compatible with Factory Rear Bumper	TB050	\$523.00
Rear Protection Towbar - Full Rear Bumper Replacement	RTB067GLS	\$1196.00
Rear Protection Towbar Plates (Pair)	RTBPLATE050	\$131.00
Towbar Wiring Loom - Plug and Play	ITBL067	\$402.00

TOWING (NOT GLS MODEL)

Class 4 Towbar - Compatible with Factory Rear Bumper	TB050	\$523.00
Rear Protection Towbar - Full Rear Bumper Replacement	RTB067GLX	\$1196.00
Rear Protection Towbar Plates (Pair)	RTBPLATE050	\$131.00
Towbar Wiring Loom - Plug and Play	ITBL067	\$402.00

RECOVERY POINTS - IRONMAN 4X4 BULL BAR ONLY

Recovery Points - 5000kg Rating (Pair) (Includes GLS Premium)	IRP059	\$300.00
---	--------	----------

LOCKSAFE DRAWER SYSTEMS

Twin Drawers - 1300mm	ITD1300	\$1469.00
Single Drawer - 1300mm	ISD1300	\$891.00
Wing Kit - 1300mm*	ITDW050	\$351.00

*Designed to suit factory tubs, will not suit ute liner without modification.

BATTERY TRAY

Suits 12" Battery	IBTRAY050	\$229.00
-------------------	-----------	----------

LONG RANGE FUEL TANK

125L* Diesel only - Fits Dual and Extra Cab only	TANK004	\$1129.00
--	---------	-----------

* Usable volume may differ to the stated tank capacity

PREMIUM UNDERBODY PROTECTION

Engine Bay and Transmission	UBP050	\$712.00
-----------------------------	--------	----------

UNDERBODY PROTECTION

Engine Bay and Transmission - Not compatible with bull bars.	IUP050K	\$562.00
--	---------	----------

EXHAUST SYSTEM

3" Exhaust Upgrade 2.4L 2015+ - DPF Back - While Stocks Last	IEX067	\$770.00
--	--------	----------





MR
11/2018+

Mitsubishi Triton

PRODUCT DESCRIPTION

PART NO.

QTY
Required

RETAIL
ea Incl GST

CANOPY - ABS PLASTIC (SIDE LIFT UP WINDOWS AND CENTRAL LOCKING REAR DOOR) - FITS 4X4 AND 4X2 DUAL CAB MODELS

Pre Primed	CANOPY014-P	\$3143.00*
Black Mica (X08)	CANOPY014-BM	\$3743.00
Impulse Blue (D23)	CANOPY014-IB	\$3743.00
Sterling Silver (U25)	CANOPY014-SS	\$3743.00
Earth Green (F27)	CANOPY014-EG	\$3743.00
Palma Red (R59)	CANOPY014-RS	\$3743.00
Graphite Grey (U28)	CANOPY014-GG	\$3743.00
White Solid (W32)	CANOPY014-WS	\$3743.00
ABS Canopy Rack Feet	IRRFETABS14	\$250.00

• See Page 33 and 34 for 1.4m Roof Rack options and pricing.

* Pre-primed canopies, plus colour coding.

CANOPY - SMOOTH FINISH FIBREGLASS PINNACLE (SIDE LIFT UP WINDOWS AND CENTRAL LOCKING REAR DOOR) - FITS 4X4 AND 4X2 DUAL CAB MODELS

Pre-Primed	CANFIBRE050-P	\$2783.00*
Black Mica (X08)	CANFIBRE050-BM	\$3297.00
Impulse Blue (D23)	CANFIBRE050-IB	\$3297.00
Graphite Grey (U28)	CANFIBRE050-GG	\$3297.00
Sterling Silver (U25)	CANFIBRE050-SS	\$3297.00
White Solid (W32)	CANFIBRE050-WS	\$3297.00

* Pre-primed canopies, plus colour coding.

SEAT COVER

Canvas Comfort - Front	ICSC050F	\$400.00
Canvas Comfort - Rear	ICSC050R	\$400.00

DIFF BREATHER KIT

Diff Breather Kit	IDIFFBRE	\$114.00
-------------------	----------	----------

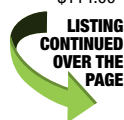



PRODUCT DESCRIPTION

PART NO.

QTY
Required

RETAIL
ea Incl GST

SUSPENSION TO SUIT MITSUBISHI TRITON MR

FRONT SUSPENSION

SHOCK ABSORBER

Nitro Gas Strut - Performance ¹			12715GR	2	\$209.09
Foam Cell Strut - Performance ¹			24715FE	2	\$235.23
Foam Cell Pro Strut - Performance* (SEE NOTE)			45715FE	2	\$365.91

*NOTE: MANDATORY FITMENT of UCA050FA and MITS045B /C Coil Springs with 45715FE

¹ Height adjustable with Ironman 4x4 Strut Trim Packers

COIL SPRINGS

	Est. Lift	Additional Load			
Standard	0mm	0 - 50kg	MITSO40S	1	\$235.23
Light	25mm	0 - 50kg	MITSO40A	1	\$235.23
Medium	30mm	0 - 80kg	MITSO40B	1	\$235.23
Medium* (SEE NOTE)	50mm	0 - 80kg	MITSO45B *	1	\$235.22
Heavy	30mm	80 - 110kg	MITSO40C	1	\$235.23
Heavy* (SEE NOTE)	50mm	80 - 110kg	MITSO45C *	1	\$235.22

*NOTE: MANDATORY FITMENT of UCA050FA and 45715FE with (MITSO45B /C) Coil Springs

STRUT MOUNTS

Steel Strut Top			ISST010	2	\$91.48
-----------------	--	--	----------------	---	---------

TRIM PACKERS

5mm Strut Trim Packer	Nitro Gas / Foam Cell	HILFR05 / HILFR05F	2	\$26.14
10mm Strut Trim Packer	Nitro Gas / Foam Cell	HILFR10 / HILFR10F	2	\$26.14
15mm Strut Trim Packer	Nitro Gas / Foam Cell	HILFR15 / HILFR15F	2	\$26.14

• ONLY Compatible with Ironman 4x4 Struts, lift height subject to 2:1 motion ratio. Unnecessary fitment may lift vehicle too high

CONTROL ARMS

Pro-Forge Upper Control Arms			UCA050FA	1	\$831.60
------------------------------	--	--	-----------------	---	----------



MR
11/2018+

Mitsubishi Triton

PRODUCT DESCRIPTION

PART NO.

QTY
RequiredRETAIL
ea Incl GST

REAR SUSPENSION

SHOCK ABSORBER

Nitro Gas - Comfort			12729GRC	2	\$143.75
Nitro Gas - Performance			12729GR	2	\$143.75
Nitro Gas - Professional			12729GRP	2	\$143.75
Foam Cell - Comfort			24729FEC	2	\$209.09
Foam Cell - Performance			24729FE	2	\$209.09
Foam Cell - Professional			24729FEP	2	\$209.09
Foam Cell Pro - Comfort			45729FEC	2	\$287.50
Foam Cell Pro - Performance			45729FE	2	\$287.50
Foam Cell Pro - Professional			45729FEP	2	\$287.50

LEAF SPRINGS

	Est. Lift	Additional Load			
Light	30mm	0 - 200kg	MITSO47A	2	\$352.84
Medium	30mm	0 - 300kg	MITSO47B	2	\$352.84
Heavy	30mm	300kg - GVM	MITSO47C	2	\$378.98

• Two piece tailshaft models may experience driveline vibration, use 1201K to reduce vibration.

U-BOLTS

U-Bolt Kit			437UBK	2	\$39.21
U-Bolt Kit		Suits MITS047C	437UBKL	2	\$39.21

POLYURETHANE SPRING BUSHES

Bush Kit			1200UK	1	\$78.41
----------	--	--	---------------	---	---------

DRIVELINE SPACERS

Centre Bearing Spacer Kit			1201K	1	\$104.55
---------------------------	--	--	--------------	---	----------

SPACER KIT

Brake Hose Relocation Kit			1205K	1	\$52.28
---------------------------	--	--	--------------	---	---------

GREASABLE SHACKLES AND PINS

Greasable Shackle			1199	2	\$52.28
Non-Greasable Pin			387-1	2	\$26.14

HELPER SPRINGS

Load Plus Helper Springs			LP3	1	\$156.82
Add-A-Leaf			ISL6010	1	\$156.82

SUSPENSION KIT

Light - Nitro Gas			MITSO47AKG		\$1960.20
Light - Foam Cell			MITSO47AKF		\$2143.16
Medium - Nitro Gas			MITSO47BKG		\$1960.20
Medium - Foam Cell			MITSO47BKF		\$2143.16
Medium - Foam Cell Pro			MITSO47BKP		\$3476.09
Heavy - Nitro Gas			MITSO47CKG		\$2012.48
Heavy - Foam Cell			MITSO47CKF		\$2195.43
Heavy - Foam Cell Pro			MITSO47CKP		\$3528.36

• Specify Front Coil Springs when ordering

• Two piece tailshaft models may experience driveline vibration, use 1201K to reduce vibration

SUSPENSION KIT CONTENTS

Shock Absorbers	Coil Springs	Upper Control Arms (Foam Cell Pro Kits Only)	Brake Hose Relocation Kit
Leaf Springs	U-Bolts	Polyurethane Spring Bushes	Centre Bearing Spacer Kit
Strut Shock Absorbers			



PRODUCT DESCRIPTION

PART NO.

QTY
RequiredRETAIL
ea Incl GST

ACCESSORIES TO SUIT MITSUBISHI TRITON

STEEL WINCH BULL BARS

Commercial	BBC050	\$1598.00
Commercial Deluxe	BBCD050	\$2021.00
Polished Alloy	BBA050	\$2517.00
Proguard No Loop	BBT050-NL	\$1670.00
Proguard Single Loop Kit	BB050-SL	\$297.00
Proguard Triple Loop Kit	BB050-TL	\$357.00
Driving Light Patch Loom - Factory LED Headlight models only	IPL050	\$30.00

STEEL SIDE STEPS AND RAILS - FITS DUAL AND CLUB CAB

Side Steps	SS050	\$851.00
Side Rails	SS050 RAIL	\$280.00
Side Steps and Rails	SSR050	\$1022.00

TOWING

Class 4 Towbar - Compatible with Factory Rear Bumper	TB050	\$523.00
Rear Protection Towbar - Full Rear Bumper Replacement	RTB050	\$1196.00
Rear Protection Towbar Plates (Pair)	RTBPLATE050	\$131.00
Towbar Wiring Loom - Plug and Play	ITBL050	\$237.00

RECOVERY POINTS - IRONMAN 4X4 BULL BAR ONLY

Recovery Points - 5000kg Rating (Pair)	IRP050	\$265.00
--	--------	----------

SNORKEL

Triton MQ 2015-10/2018 Only - Suits 2.4L Diesel Only	ISNORKELO50	\$387.00
--	-------------	----------

LOCKSAFE DRAWER SYSTEMS

Twin Drawers - 1300mm	ITD1300	\$1469.00
Single Drawer - 1300mm	ISD1300	\$891.00
Wing Kit - 1300mm*	ITDW050	\$351.00

*Designed to suit factory tubs, will not suit ute liner without modification.

BATTERY TRAY

Suits 12" Battery	IBTRAY050	\$229.00
-------------------	-----------	----------

LONG RANGE FUEL TANK

125L* Diesel only - Fits Dual and Extra Cab only	TANK004	\$1129.00
--	---------	-----------

* Usable volume may differ to the stated tank capacity

PREMIUM UNDERBODY PROTECTION

Engine Bay and Transmission	UBP050	\$712.00
-----------------------------	--------	----------

UNDERBODY PROTECTION

Engine Bay and Transmission - Not compatible with bull bars.	IUP050K	\$562.00
--	---------	----------

EXHAUST SYSTEM

3" Exhaust Upgrade 2.4L 2015+ - DPF Back - While Stocks Last	IEX067	\$770.00
--	--------	----------





MQ
2015 to 10/2018

Mitsubishi Triton

PRODUCT DESCRIPTION

PART NO.

QTY Required

RETAIL ea Incl GST

CANOPY - ABS PLASTIC (SIDE LIFT UP WINDOWS AND CENTRAL LOCKING REAR DOOR) - FITS 4X4 AND 4X2 DUAL CAB MODELS

Pre Primed	CANOPY014-P		\$3143.00*
Black Mica (X08)	CANOPY014-BM		\$3743.00
Impulse Blue (D23)	CANOPY014-IB		\$3743.00
Sterling Silver (U25)	CANOPY014-SS		\$3743.00
Earth Green (F27)	CANOPY014-EG		\$3743.00
Palma Red (R59)	CANOPY014-RS		\$3743.00
Titanium Grey (U17)	CANOPY014-TG		\$3743.00
White Solid (W32)	CANOPY014-WS		\$3743.00
ABS Canopy Rack Feet	IRRFETABS14		\$250.00

• See Page 33 and 34 for 1.4m Roof Rack options and pricing.

* Pre-primed canopies, plus colour coding.

CANOPY - SMOOTH FINISH FIBREGLASS PINNACLE (SIDE LIFT UP WINDOWS AND CENTRAL LOCKING REAR DOOR) - FITS 4X4 AND 4X2 DUAL CAB MODELS

Pre-Primed	CANFIBRE050-P		\$2783.00*
Black Mica (X08)	CANFIBRE050-BM		\$3297.00
Impulse Blue (D23)	CANFIBRE050-IB		\$3297.00
Titanium Grey (U17)	CANFIBRE050-TG		\$3297.00
Sterling Silver (U25)	CANFIBRE050-SS		\$3297.00
White Solid (W32)	CANFIBRE050-WS		\$3297.00

* Pre-primed canopies, plus colour coding.

SEAT COVER

Canvas Comfort - Front	ICSC050F		\$400.00
Canvas Comfort - Rear	ICSC050R		\$400.00

DIFF BREATHER KIT

Diff Breather Kit	IDIFFBRE		\$114.00
-------------------	----------	--	----------





PRODUCT DESCRIPTION

PART NO.

QTY
Required

RETAIL
ea Incl GST

SUSPENSION TO SUIT MITSUBISHI TRITON

FRONT SUSPENSION

SHOCK ABSORBER

Nitro Gas Strut - Performance ¹			12715GR	2	\$209.09
Foam Cell Strut - Performance ¹			24715FE	2	\$235.23
Foam Cell Pro Strut - Performance* (SEE NOTE)			45715FE	2	\$365.91

*NOTE: MANDATORY FITMENT of UCA050FA and MITS045B /C Coil Springs with 45715FE

¹ Height adjustable with Ironman 4x4 Strut Trim Packers

COIL SPRINGS

	Est. Lift	Additional Load			
Standard	0mm	0 - 50kg	MITSO40S	1	\$235.23
Light	25mm	0 - 50kg	MITSO40A	1	\$235.23
Medium	30mm	0 - 80kg	MITSO40B	1	\$235.23
Medium* (SEE NOTE)	50mm	0 - 80kg	MITSO45B *	1	\$235.22
Heavy	30mm	80 - 110kg	MITSO40C	1	\$235.23
Heavy* (SEE NOTE)	50mm	80 - 110kg	MITSO45C *	1	\$235.22

*NOTE: MANDATORY FITMENT of UCA050FA and 45715FE with (MITSO45B /C) Coil Springs

STRUT MOUNTS

Steel Strut Top			ISST010	2	\$91.48
-----------------	--	--	----------------	---	---------

TRIM PACKERS

5mm Strut Trim Packer	Nitro Gas / Foam Cell	HILFR05 / HILFR05F	2	\$26.14
10mm Strut Trim Packer	Nitro Gas / Foam Cell	HILFR10 / HILFR10F	2	\$26.14
15mm Strut Trim Packer	Nitro Gas / Foam Cell	HILFR15 / HILFR15F	2	\$26.14

• ONLY Compatible with Ironman 4x4 Struts, lift height subject to 2:1 motion ratio. Unnecessary fitment may lift vehicle too high

CONTROL ARMS

Pro-Forge Upper Control Arms			UCA050FA	1	\$831.60
------------------------------	--	--	-----------------	---	----------





MQ L200
2015 to 10/2018

SUSPENSION TO SUIT

Mitsubishi Triton

PRODUCT DESCRIPTION

PART NO.

QTY
Required

RETAIL
ea Incl GST

REAR SUSPENSION

SHOCK ABSORBER

Nitro Gas - Comfort			12729GRC	2	\$143.75
Nitro Gas - Performance			12729GR	2	\$143.75
Nitro Gas - Professional			12729GRP	2	\$143.75
Foam Cell - Comfort			24729FEC	2	\$209.09
Foam Cell - Performance			24729FE	2	\$209.09
Foam Cell - Professional			24729FEP	2	\$209.09
Foam Cell Pro - Comfort			45729FEC	2	\$287.50
Foam Cell Pro - Performance			45729FE	2	\$287.50
Foam Cell Pro - Professional			45729FEP	2	\$287.50

LEAF SPRINGS

	Est. Lift	Additional Load			
Light	30mm	0 - 200kg	MITSO47A	2	\$352.84
Medium	30mm	0 - 300kg	MITSO47B	2	\$352.84
Heavy	30mm	300kg - GVM	MITSO47C	2	\$378.98

• Two piece tailshaft models may experience driveline vibration, use 1201K to reduce vibration.

U-BOLTS

U-Bolt Kit			437UBK	2	\$39.21
U-Bolt Kit		Suits MITS047C	437UBKL	2	\$39.21

POLYURETHANE SPRING BUSHES

Bush Kit			1200UK	1	\$78.41
----------	--	--	---------------	---	---------

DRIVELINE SPACERS

Centre Bearing Spacer Kit			1201K	1	\$104.55
---------------------------	--	--	--------------	---	----------

SPACER KIT

Brake Hose Relocation Kit			1205K	1	\$52.28
---------------------------	--	--	--------------	---	---------

GREASABLE SHACKLES AND PINS

Greasable Shackle			1199	2	\$52.28
Non-Greasable Pin			387-1	2	\$26.14

HELPER SPRINGS

Load Plus Helper Springs			LP3	1	\$156.82
Add-A-Leaf			ISL6010	1	\$156.82

SUSPENSION KIT

Light - Nitro Gas			MITSO47AKG		\$1960.20
Light - Foam Cell			MITSO47AKF		\$2143.16
Medium - Nitro Gas			MITSO47BKG		\$1960.20
Medium - Foam Cell			MITSO47BKF		\$2143.16
Medium - Foam Cell Pro			MITSO47BKP		\$3476.09
Heavy - Nitro Gas			MITSO47CKG		\$2012.48
Heavy - Foam Cell			MITSO47CKF		\$2195.43
Heavy - Foam Cell Pro			MITSO47CKP		\$3528.36

• Specify Front Coil Springs when ordering

• Two piece tailshaft models may experience driveline vibration, use 1201K to reduce vibration

SUSPENSION KIT CONTENTS

Shock Absorbers	Coil Springs	Upper Control Arms (Foam Cell Pro Kits Only)	Brake Hose Relocation Kit
Leaf Springs	U-Bolts	Polyurethane Spring Bushes	Centre Bearing Spacer Kit
Strut Shock Absorbers			





Delivered straight from the dealership...
built your way!



for a full range of accessories visit our website

www.ironman4x4.com





MN
2009 to 2015

Mitsubishi Triton

PRODUCT DESCRIPTION

PART NO.

QTY Required

RETAIL ea Incl GST

ACCESSORIES TO SUIT MITSUBISHI TRITON

STEEL WINCH BULL BARS

Commercial	BBC031	\$1569.00
Commercial Deluxe	BBCD031	\$1985.00
Protector - <i>While Stocks Last</i>	BBT031	\$2009.00

• Can also be fitted to both 2WD and 4WD models.

STEEL SIDE STEPS AND RAILS - FITS DUAL CAB, EXTRA CAB AND SINGLE CAB

Side Steps	SS031	\$851.00
Side Steps and Rails	SSR031	\$1022.00

LOCKSAFE DRAWER SYSTEMS

Twin Drawers - 1300mm	ITD1300	\$1469.00
Single Drawer - 1300mm	ISD1300	\$891.00
Wing Kit - 1300mm*	ITDW032	\$351.00

*Designed to suit factory tubs, will not suit ute liner without modification.

SNORKEL

Triton	ISNORKEL020	\$387.00
--------	-------------	----------

EXHAUST SYSTEM

BigBore Triton MN - Diesel Only (Automatic Transmission) - <i>While Stocks Last</i>	IEXHAUST019	\$1300.00
BigBore Triton MN - Diesel Only (Manual Transmission) - <i>While Stocks Last</i>	IEXHAUST018	\$1300.00

LONG RANGE FUEL TANK

125L* Diesel - Fits Dual Cab only	TANK004	\$1129.00
125L* Petrol - Fits Dual Cab only	TANK005	\$1129.00

* Usable volume may differ to the stated tank capacity

• Modification required with factory rear diff-lock.

CANOPY - ABS PLASTIC (SIDE LIFT UP WINDOWS) - FITS 4X4 AND 4X2 DUAL CAB MODELS

Pre-Primed	CANOPY008-P	\$3143.00*
Blue Mica (T64)	CANOPY008-BM	\$3743.00

* Pre-primed canopies, plus colour coding.

SEAT COVER

Canvas Comfort - Front	ICSC031F	\$400.00
Canvas Comfort - Rear	ICSC031R	\$400.00

DIFF BREATHER KIT

Diff Breather Kit	IDIFFBRE	\$114.00
-------------------	----------	----------

LISTING
CONTINUED
OVER THE
PAGE



PRODUCT DESCRIPTION

PART NO.

QTY
RequiredRETAIL
ea Incl GST

SUSPENSION TO SUIT MITSUBISHI TRITON

FRONT SUSPENSION

SHOCK ABSORBER

Nitro Gas Strut - Performance ¹			12715GR	2	\$209.09
Foam Cell Strut - Performance ¹			24715FE	2	\$235.23
Foam Cell Pro Strut - Performance* (SEE NOTE)			45715FE	2	\$365.91

*NOTE: MANDATORY FITMENT of UCA050FA and MITS045B /C Coil Springs with 45715FE

¹ Height adjustable with Ironman 4x4 Strut Trim Packers

COIL SPRINGS

	Est. Lift	Additional Load			
Standard	0mm	0 - 50kg	MITS040S	1	\$235.23
Light	25mm	0 - 50kg	MITS040A	1	\$235.23
Medium	30mm	0 - 80kg	MITS040B	1	\$235.23
Medium* (SEE NOTE)	50mm	0 - 80kg	MITS045B *	1	\$235.22
Heavy	30mm	80 - 110kg	MITS040C	1	\$235.23
Heavy* (SEE NOTE)	50mm	80 - 110kg	MITS045C *	1	\$235.22

*NOTE: MANDATORY FITMENT of UCA050FA and 45715FE with (MITS045B /C) Coil Springs

STRUT MOUNTS

Steel Strut Top			ISST010	2	\$91.48
-----------------	--	--	----------------	---	---------

TRIM PACKERS

5mm Strut Trim Packer	Nitro Gas / Foam Cell	HILFR05 / HILFR05F	2	\$26.14
10mm Strut Trim Packer	Nitro Gas / Foam Cell	HILFR10 / HILFR10F	2	\$26.14
15mm Strut Trim Packer	Nitro Gas / Foam Cell	HILFR15 / HILFR15F	2	\$26.14

CONTROL ARMS

Pro-Forge Upper Control Arms			UCA050FA	1	\$831.60
------------------------------	--	--	-----------------	---	----------





MN L200
2009 to 2015

Mitsubishi Triton

PRODUCT DESCRIPTION

PART NO.

QTY Required

RETAIL ea Incl GST

REAR SUSPENSION

SHOCK ABSORBER

Nitro Gas - Comfort			12636GRC	2	\$143.75
Nitro Gas - Performance			12636GR	2	\$143.75
Nitro Gas - Professional			12636GRP	2	\$143.75
Foam Cell - Comfort			24636FEC	2	\$209.09
Foam Cell - Performance			24636FE	2	\$209.09
Foam Cell - Professional			24636FEP	2	\$209.09
Foam Cell Pro - Comfort			45636FEC	2	\$287.50
Foam Cell Pro - Performance			45636FE	2	\$287.50
Foam Cell Pro - Professional			45636FEP	2	\$287.50

LEAF SPRINGS

	Est. Lift	Additional Load			
Light	40mm	0 - 200kg	MITSO41A	2	\$352.84
Medium	40mm	0 - 300kg	MITSO41B	2	\$352.84
Heavy	40mm	300kg - GVM	MITSO41C	2	\$378.98

- Must use Ironman 4x4 bushes.
- Unladen manual vehicles with 2 piece tail shaft may experience vibration in first gear.

U-BOLTS

U-Bolt Kit			1102UBK	2	\$39.21
------------	--	--	----------------	---	---------

POLYURETHANE SPRING BUSHES

Bush Kit			715TUK	1	\$78.41
----------	--	--	---------------	---	---------

- Not compatible with OEM springs

GREASABLE SHACKLES AND PINS

Greasable Shackle			795	2	\$52.28
Non-Greasable Pin			387-1	2	\$26.14

HELPER SPRINGS

Load Plus Helper Springs			LP4	1	\$156.82
--------------------------	--	--	------------	---	----------

SUSPENSION KIT

Light - Nitro Gas			MITSO41AKG		\$1803.39
Light - Foam Cell			MITSO41AKF		\$1986.34
Medium - Nitro Gas			MITSO41BKG		\$1803.39
Medium - Foam Cell			MITSO41BKF		\$1986.34
Medium - Foam Cell Pro			MITSO41BKP		\$3319.28
Heavy - Nitro Gas			MITSO41CKG		\$1855.66
Heavy - Foam Cell			MITSO41CKF		\$2038.61
Heavy - Foam Cell Pro			MITSO41CKP		\$3371.55

- Specify Front Coil Springs when ordering
- Unladen manual vehicles with 2 piece tail shaft may experience vibration in first gear

SUSPENSION KIT CONTENTS

Shock Absorbers	Leaf Springs	U-Bolts	Polyurethane Spring Bushes
Strut Shock Absorbers	Coil Springs	Upper Control Arms (Foam Cell Pro Kits Only)	



PRODUCT DESCRIPTION

PART NO.

QTY
RequiredRETAIL
ea Incl GST

ACCESSORIES TO SUIT MITSUBISHI TRITON

STEEL WINCH BULL BARS

Commercial - <i>While Stocks Last</i>	BBC016	\$1569.00
Commercial Deluxe	BBCD016	\$1985.00
Protector - <i>While Stocks Last</i>	BBT016	\$2009.00

• Can also be fitted to both 2WD and 4WD models.

STEEL SIDE STEPS AND RAILS - FITS DUAL CAB AND EXTRA CAB MODELS ONLY

Side Steps and Rails	SSR031	\$1022.00
----------------------	--------	-----------

LOCKSAFE DRAWER SYSTEMS

Twin Drawers - 1300mm	ITD1300	\$1469.00
Single Drawer - 1300mm	ISD1300	\$891.00
Wing Kit - 1300mm*	ITDW031	\$351.00

*Designed to suit factory tubs, will not suit ute liner without modification.

SNORKEL

ML Triton 2006 to 2009	ISNORKEL020	\$387.00
------------------------	-------------	----------

LONG RANGE FUEL TANK

125L* Diesel (Not compatible with factory diff-lock) - Fits Dual Cab only	TANK004	\$1129.00
125L* Petrol (Not compatible with factory diff-lock) - Fits Dual Cab only	TANK005	\$1129.00

*Usable volume may differ to the stated tank capacity

• Modification required with factory rear diff-lock.

UNDERBODY PROTECTION

Engine Bay and Transmission	IUP010K	\$562.00
Fuel Tank	IUP010F	\$296.00

• Fuel tank protection plates are not compatible with long range fuel tanks.

SEAT COVER

Canvas Comfort - Front	ICSC031F	\$400.00
Canvas Comfort - Rear	ICSC031R	\$400.00

DIFF BREATHER KIT

Diff Breather Kit	IDIFFBRE	\$114.00
-------------------	----------	----------





ML L200
2006 to 2009

Mitsubishi Triton

PRODUCT DESCRIPTION

PART NO.

QTY
Required

RETAIL
ea Incl GST

SUSPENSION TO SUIT MITSUBISHI TRITON

FRONT SUSPENSION

SHOCK ABSORBER

Nitro Gas Strut - Performance ¹			12715GR	2	\$209.09
Foam Cell Strut - Performance ¹			24715FE	2	\$235.23
Foam Cell Pro Strut - Performance* (SEE NOTE)			45715FE	2	\$365.91

*NOTE: MANDATORY FITMENT of UCA050FA and MITS045B /C Coil Springs with 45715FE

¹ Height adjustable with Ironman 4x4 Strut Trim Packers

COIL SPRINGS

	Est. Lift	Additional Load			
Standard	0mm	0 - 50kg	MITSO40S	1	\$235.23
Light	25mm	0 - 50kg	MITSO40A	1	\$235.23
Medium	30mm	0 - 80kg	MITSO40B	1	\$235.23
Medium* (SEE NOTE)	50mm	0 - 80kg	MITSO45B *	1	\$235.22
Heavy	30mm	80 - 110kg	MITSO40C	1	\$235.23
Heavy* (SEE NOTE)	50mm	80 - 110kg	MITSO45C *	1	\$235.22

*NOTE: MANDATORY FITMENT of UCA050FA and 45715FE with (MITSO45B /C) Coil Springs

STRUT MOUNTS

Steel Strut Top			ISST010	2	\$91.48
-----------------	--	--	----------------	---	---------

TRIM PACKERS

5mm Strut Trim Packer	Nitro Gas / Foam Cell	HILFR05 / HILFR05F	2	\$26.14
10mm Strut Trim Packer	Nitro Gas / Foam Cell	HILFR10 / HILFR10F	2	\$26.14
15mm Strut Trim Packer	Nitro Gas / Foam Cell	HILFR15 / HILFR15F	2	\$26.14

CONTROL ARMS

Pro-Forge Upper Control Arms			UCA050FA	1	\$831.60
------------------------------	--	--	-----------------	---	----------

REAR SUSPENSION

SHOCK ABSORBER

Nitro Gas - Comfort			12636GRC	2	\$143.75
Nitro Gas - Performance			12636GR	2	\$143.75
Nitro Gas - Professional			12636GRP	2	\$143.75
Foam Cell - Comfort			24636FEC	2	\$209.09
Foam Cell - Performance			24636FE	2	\$209.09
Foam Cell - Professional			24636FEP	2	\$209.09
Foam Cell Pro - Comfort			45636FEC	2	\$287.50
Foam Cell Pro - Performance			45636FE	2	\$287.50
Foam Cell Pro - Professional			45636FEP	2	\$287.50

LEAF SPRINGS

	Est. Lift	Additional Load			
Light	40mm	0 - 200kg	MITSO41A	2	\$352.84
Medium	40mm	0 - 300kg	MITSO41B	2	\$352.84
Heavy	40mm	300kg - GVM	MITSO41C	2	\$378.98

• Must use Ironman 4x4 bushes.

• Unladen manual vehicles with 2 piece tail shaft may experience vibration in first gear.

U-BOLTS

U-Bolt Kit			1102UBK	2	\$39.21
------------	--	--	----------------	---	---------

POLYURETHANE SPRING BUSHES

Bush Kit			715TUK	1	\$78.41
----------	--	--	---------------	---	---------

• Not compatible with OEM springs

GREASABLE SHACKLES AND PINS

Greasable Shackle			795	2	\$52.28
Non-Greasable Pin			387-1	2	\$26.14

HELPER SPRINGS

Load Plus Helper Springs			LP4	1	\$156.82
--------------------------	--	--	------------	---	----------

LISTING
CONTINUED
OVER THE
PAGE

Mitsubishi Triton

ML L200
2006 to 2009



PRODUCT DESCRIPTION

PART NO.

QTY
Required

RETAIL
ea Incl GST

SUSPENSION KIT

Light - Nitro Gas	MITSO41AKG	\$1803.39
Light - Foam Cell	MITSO41AKF	\$1986.34
Medium - Nitro Gas	MITSO41BKG	\$1803.39
Medium - Foam Cell	MITSO41BKF	\$1986.34
Medium - Foam Cell Pro	MITSO41BKP	\$3319.28
Heavy - Nitro Gas	MITSO41CKG	\$1855.66
Heavy - Foam Cell	MITSO41CKF	\$2038.61
Heavy - Foam Cell Pro	MITSO41CKP	\$3371.55

- Specify Front Coil Springs when ordering
- Unladen manual vehicles with 2 piece tail shaft may experience vibration in first gear

SUSPENSION KIT CONTENTS

Shock Absorbers	Leaf Springs	U-Bolts	Polyurethane Spring Bushes
Strut Shock Absorbers	Coil Springs	Upper Control Arms (Foam Cell Pro Kits Only)	





MK L200
1996 to 2006

Mitsubishi Triton

PRODUCT DESCRIPTION

PART NO.

QTY Required

RETAIL ea Incl GST

SUSPENSION TO SUIT MITSUBISHI TRITON

FRONT SUSPENSION

SHOCK ABSORBER

Nitro Gas - Performance		12087GR	2	\$143.75
Foam Cell - Performance		24087FE	2	\$209.09

TORSION BAR

Uprated Torsion Bars		MITSO15C	1	\$392.04
----------------------	--	-----------------	---	----------

• Minimum 60mm downward suspension travel required after adjustment

STEERING DAMPER

Foam Cell	Suits vehicles w/o power steering	3517	1	\$156.82
-----------	-----------------------------------	-------------	---	----------

REAR SUSPENSION

SHOCK ABSORBER

Nitro Gas - Comfort		12698GRC	2	\$143.75
Nitro Gas - Performance		12698GR	2	\$143.75
Nitro Gas - Professional		12698GRP	2	\$143.75
Foam Cell - Comfort		24698FEC	2	\$209.09
Foam Cell - Performance		24698FE	2	\$209.09
Foam Cell - Professional		24698FEP	2	\$209.09

LEAF SPRINGS

	Est. Lift	Additional Load			
Medium	40mm	0 - 300kg	MITSO18B	2	\$352.84
Heavy	40mm	300kg - GVM	MITSO18C	2	\$378.98

• Must use Ironman 4x4 bushes

U-BOLTS

U-Bolt Kit		451UBK	2	\$39.21
------------	--	---------------	---	---------

POLYURETHANE SPRING BUSHES

Bush Kit		715TUK	1	\$78.41
----------	--	---------------	---	---------

• Not compatible with OEM springs

GREASABLE SHACKLES AND PINS

Greasable Shackle		795	2	\$52.28
Non-Greasable Pin		387-1	2	\$26.14

HELPER SPRINGS

Load Plus Helper Springs		LP4	1	\$156.82
--------------------------	--	------------	---	----------

SUSPENSION KIT

Medium - Nitro Gas		MITSO15BKG1		\$1829.52
Medium - Foam Cell		MITSO15BKF1		\$2090.88
Heavy - Nitro Gas		MITSO15CKG1		\$1881.80
Heavy - Foam Cell		MITSO15CKF1		\$2143.16

SUSPENSION KIT CONTENTS

Shock Absorbers	Coil Springs	Polyurethane Spring Bushes	Strut Shock Absorbers
Leaf Springs	U-Bolts	Brake Hose Relocation Kit	



PRODUCT DESCRIPTION

PART NO.

QTY
RequiredRETAIL
ea Incl GST

SUSPENSION TO SUIT MITSUBISHI TRITON

FRONT SUSPENSION

SHOCK ABSORBER

Nitro Gas - Performance		12082GR	2	\$143.75
Foam Cell - Performance		24082FE	2	\$209.09

TORSION BAR

Uprated Torsion Bars		MITS015C	1	\$392.04
----------------------	--	-----------------	---	----------

• Minimum 60mm downward suspension travel required after adjustment

STEERING DAMPER

Foam Cell	Suits vehicles w/o power steering	3517	1	\$156.82
-----------	-----------------------------------	-------------	---	----------

REAR SUSPENSION

SHOCK ABSORBER

Nitro Gas - Comfort		12636GRC	2	\$143.75
Nitro Gas - Performance		12636GR	2	\$143.75
Nitro Gas - Professional		12636GRP	2	\$143.75
Foam Cell - Comfort		24636FEC	2	\$209.09
Foam Cell - Performance		24636FE	2	\$209.09
Foam Cell - Professional		24636FEP	2	\$209.09

LEAF SPRINGS

	Est. Lift	Additional Load			
Medium	40mm	0 - 300kg	MITS018B	2	\$352.84
Heavy	40mm	300kg - GVM	MITS018C	2	\$378.98

• Must use Ironman 4x4 bushes

U-BOLTS

U-Bolt Kit		451UBK	2	\$39.21
------------	--	---------------	---	---------

POLYURETHANE SPRING BUSHES

Bush Kit		715TUK	1	\$78.41
----------	--	---------------	---	---------

• Not compatible with OEM springs

GREASABLE SHACKLES AND PINS

Greasable Shackle		795	2	\$52.28
Non-Greasable Pin		387-1	2	\$26.14

HELPER SPRINGS

Load Plus Helper Springs		LP4	1	\$156.82
--------------------------	--	------------	---	----------

SUSPENSION KIT

Medium - Nitro Gas		MITS015BKG		\$1829.52
Medium - Foam Cell		MITS015BKF		\$2090.88
Heavy - Nitro Gas		MITS015CKG		\$1881.80
Heavy - Foam Cell		MITS015CKF		\$2143.16

SUSPENSION KIT CONTENTS

Shock Absorbers	Torsion Bars	Polyurethane Spring Bushes
Leaf Springs	U-Bolts	



L200
Pre 1993

Mitsubishi Triton

PRODUCT DESCRIPTION

PART NO.

QTY
Required

RETAIL
ea Incl GST

SUSPENSION TO SUIT MITSUBISHI TRITON

FRONT SUSPENSION

SHOCK ABSORBER

Nitro Gas - Performance		12082GR	2	\$143.75
Foam Cell - Performance		24082FE	2	\$209.09

TORSION BAR

Uprated Torsion Bars		MITSO13	1	\$392.04
----------------------	--	----------------	---	----------

• Minimum 60mm downward suspension travel required after adjustment

STEERING DAMPER

Foam Cell	Suits vehicles w/o power steering	3517	1	\$156.82
-----------	-----------------------------------	-------------	---	----------

REAR SUSPENSION

SHOCK ABSORBER

Nitro Gas - Comfort		12636GRC	2	\$143.75
Nitro Gas - Performance		12636GR	2	\$143.75
Nitro Gas - Professional		12636GRP	2	\$143.75
Foam Cell - Comfort		24636FEC	2	\$209.09
Foam Cell - Performance		24636FE	2	\$209.09
Foam Cell - Professional		24636FEP	2	\$209.09

LEAF SPRINGS

	Est. Lift	Additional Load			
Medium	45mm	0 - 300kg	MITSO18B	2	\$352.84
Heavy	45mm	300kg - GVM	MITSO18C	2	\$378.98

• Must use Ironman 4x4 bushes

U-BOLTS

U-Bolt Kit		451UBK	2	\$39.21
------------	--	---------------	---	---------

POLYURETHANE SPRING BUSHES

Bush Kit		715UK	1	\$78.41
----------	--	--------------	---	---------

GREASABLE SHACKLES AND PINS

Greasable Shackle		795	2	\$52.28
Greasable Pin		796	2	\$26.14

HELPER SPRINGS

Load Plus Helper Springs		LP4	1	\$156.82
--------------------------	--	------------	---	----------

SUSPENSION KIT

Medium - Nitro Gas		MITSO18BKG1		\$1829.52
Medium - Foam Cell		MITSO18BKF1		\$2090.88
Heavy - Nitro Gas		MITSO18CKG1		\$1881.80
Heavy - Foam Cell		MITSO18CKF1		\$2143.16

SUSPENSION KIT CONTENTS

Shock Absorbers	Torsion Bars	Polyurethane Spring Bushes
Leaf Springs	U-Bolts	



PRODUCT DESCRIPTION

PART NO.

QTY
RequiredRETAIL
ea Incl GST

ACCESSORIES TO SUIT NISSAN NAVARA

STEEL WINCH BULL BARS - THAI BUILT MODEL ONLY (SUITS WIDE BODY)

Commercial	BBC048	\$1569.00*
Commercial Deluxe	BBCD048	\$1985.00*
Polished Alloy	BBA048	\$2472.00
Proguard No Loop	BBT048-NL	\$1641.00
Proguard Single Loop Kit	BB048-SL	\$297.00
Proguard Triple Loop Kit	BB048-TL	\$357.00
Driving Light Patch Loom - Factory LED Headlight models only	IPL048	\$30.00
* Nissan Australia recommend installation of heavy duty front coil springs when installing a bull bar - Aust Only	NISS040C	\$235.41

STEEL SIDE STEPS AND RAILS - FITS DUAL CAB MODELS ONLY

Side Steps	SS048	\$851.00
Side Rails	SS048 RAIL	\$280.00
Side Steps and Rails	SSR048	\$1022.00

TOWING

Class 4 Towbar - Compatible with Factory Rear Bumper	TB048	\$523.00
Rear Protection Towbar - Full Rear Bumper Replacement	RTB048	\$1196.00
Rear Protection Towbar Plates (Pair)	RTBPLATE048	\$131.00
Towbar Wiring Loom - Plug and Play	ITBL048	\$248.00

RECOVERY POINTS - IRONMAN 4X4 BULL BAR ONLY

Recovery Points - 5000kg Rating (Pair)	IRP005	\$200.00
--	--------	----------

LOCKSAFE DRAWER SYSTEMS - FITS DUAL AND EXTRA CAB

Twin Drawers - 1300mm	ITD1300	\$1469.00
Single Drawer - 1300mm	ISD1300	\$891.00
Wing Kit - 1300mm*	ITDW048	\$351.00

*Designed to suit factory tubs, will not suit ute liner without modification.

SNORKEL

Suits wide and narrow body 2.3 twin and single turbo diesel	ISNORKELO48	\$387.00
---	-------------	----------

LONG RANGE FUEL TANK

140L* - Auto/Coil Spring Diesel only	TANK048	\$1129.00
--------------------------------------	---------	-----------

* Usable volume may differ to the stated tank capacity

PREMIUM UNDERBODY PROTECTION

Engine Bay and Transmission - Series 1	UBP048	\$712.00
Engine Bay and Transmission - Series 2, 3 and 4	UBP048S	\$712.00

EXHAUST SYSTEM

3" Exhaust Upgrade 2.3L - DPF Back - While Stocks Last	IEX048	\$770.00
--	--------	----------

CANOPY - ABS PLASTIC (SIDE LIFT UP WINDOWS AND CENTRAL LOCKING REAR DOOR) - FITS 4X4 AND 4X2 DUAL CAB MODELS

White (QM1)	CANOPY013-PW	\$3743.00
Brilliant Silver (K23)	CANOPY013-BS	\$3743.00
White Diamond (QX1)	CANOPY013-WP	\$3743.00
Cosmic Black (G42)	CANOPY013-CB	\$3743.00
Slate Grey (K21)	CANOPY013-SG	\$3743.00
ABS Canopy Rack Feet	IRRFETABS14	\$250.00

* See Page 33 and 34 for 1.4m Roof Rack options and pricing.

CANOPY - SMOOTH FINISH FIBREGLASS PINNACLE (SIDE LIFT UP WINDOWS AND CENTRAL LOCKING REAR DOOR) - FITS 4X4 AND 4X2 DUAL CAB MODELS

Pre-Primed	CANFIBRE048-P	\$2783.00*
White (QM1)	CANFIBRE048-PW	\$3297.00
Brilliant Silver (K23)	CANFIBRE048-BS	\$3297.00
Hornet Gold (EAU)	CANFIBRE048-HG	\$3297.00
White Diamond (QX1)	CANFIBRE048-WP	\$3297.00
Cosmic Black (G42)	CANFIBRE048-CB	\$3297.00
Slate Grey (K21)	CANFIBRE048-SG	\$3297.00

* Pre-primed canopies, plus colour coding.

SEAT COVER

Canvas Comfort - Front	ICSC048F	\$400.00
Canvas Comfort - Rear (Does not suit series 3)	ICSC048R	\$400.00
Canvas Comfort - Rear (Suits series 3)	ICSC048MYR	\$400.00

DIFF BREATHER KIT

Diff Breather Kit	IDIFFBRE	\$114.00
-------------------	----------	----------



Nissan Navara

NP300 (Coil Springs)
2015 to 2020

PRODUCT DESCRIPTION

PART NO.

QTY
RequiredRETAIL
ea Incl GST

SUSPENSION TO SUIT NISSAN NAVARA

FRONT SUSPENSION

SHOCK ABSORBER

Nitro Gas Strut - Performance			12716GR	2	\$209.09
Foam Cell Strut - Performance			24716FE	2	\$235.23
Foam Cell Pro Strut - Performance			45716FE	2	\$365.91
Foam Cell Pro Strut - Performance - Long Travel* (SEE NOTE)			45716LFE *	2	\$365.91

*NOTE: MANDATORY FITMENT of Ironman 4x4 UCA048FA is required with Long Travel - Foam Cell Pro

- Height adjustable with Ironman 4x4 Strut Trim Packers
- Foam Cell Pro contains a single adjusting ring for driveshaft clearance

COIL SPRINGS

	Est. Lift	Additional Load			
Standard	0mm	0 - 50kg	NISS040A	1	\$235.23
Light	20mm	0 - 50kg	NISS040B	1	\$235.23
Medium	35mm	0 - 80kg	NISS040C	1	\$235.41
Heavy	40mm	50 - 110kg	NISS040D	1	\$235.23

• Series 3+ vehicles are produced with a 25mm increased ride height from factory. The resulting lift estimates with Ironman 4x4 suspension will be 25mm less than stated above

STRUT MOUNTS

Steel Strut Top			ISST007	2	\$78.41
-----------------	--	--	----------------	---	---------

TRIM PACKERS

5mm Strut Trim Packer	Nitro Gas / Foam Cell	HILFR05 / HILFR05F	2	\$26.14
10mm Strut Trim Packer	Nitro Gas / Foam Cell	HILFR10 / HILFR10F	2	\$26.14
15mm Strut Trim Packer	Nitro Gas / Foam Cell	HILFR15 / HILFR15F	2	\$26.14

• ONLY Compatible with Ironman 4x4 Struts (except Pro), lift height subject to 2:1 motion ratio. Unnecessary fitment may lift vehicle too high

CONTROL ARMS

Pro-Forge Upper Control Arms			UCA048FA	1	\$831.60
------------------------------	--	--	-----------------	---	----------

REAR SUSPENSION

SHOCK ABSORBER

Nitro Gas - Performance			12728GR	2	\$143.75
Foam Cell - Performance			24728FE	2	\$209.09
Foam Cell - Professional			24728FEP	2	\$209.09
Foam Cell Pro - Comfort			45728FEC	2	\$287.50
Foam Cell Pro - Performance			45728FE	2	\$287.50
Foam Cell Pro - Professional			45728FEP	2	\$287.50

COIL SPRINGS

	Est. Lift	Additional Load			
Light	20mm	0 - 200kg	NISS058A	1	\$235.23
Medium	40mm	0 - 300kg	NISS058B	1	\$235.23
Heavy	40mm	300kg - 600kg	NISS058C	1	\$235.23
Extra Heavy	45mm	600kg - GVM	NISS058D	1	\$235.23

• Series 3+ vehicles are produced with a 25mm increased ride height from factory. The resulting lift estimated with Ironman 4x4 suspension will be 25mm less than stated above

COIL SPACER

Polyurethane 20mm			NAVR20	2	\$39.21
-------------------	--	--	---------------	---	---------

SPACER KIT

Sway Bar and Headlight Bracket Extension Kit			1204K	1	\$91.48
--	--	--	--------------	---	---------

SUSPENSION KIT

Medium - Nitro Gas	NISS058BKG	\$1267.60
Medium - Foam Cell	NISS058BKF	\$1450.55
Medium - Foam Cell Pro	NISS058BKP	\$1868.73
Heavy - Nitro Gas	NISS058CKG	\$1267.60
Heavy - Foam Cell	NISS058CKF	\$1450.55
Heavy - Foam Cell Pro	NISS058CKP	\$1868.73
Extra Heavy - Nitro Gas	NISS058DKG	\$1267.60
Extra Heavy - Foam Cell	NISS058DKF	\$1450.55
Extra Heavy - Foam Cell Pro	NISS058DKP	\$1868.73

• Specify front Coil Springs when ordering

• Series 3+ vehicles are produced with a 25mm increased ride height from factory. The resulting lift estimated with Ironman 4x4 suspension will be 25mm less than stated above

SUSPENSION KIT CONTENTS

Shock Absorbers	Strut Shock Absorbers
Coil Springs	Sway Bar and Headlight Bracket Kit





PRODUCT DESCRIPTION

PART NO.

QTY
RequiredRETAIL
ea Incl GST

SUSPENSION TO SUIT NISSAN NAVARA

FRONT SUSPENSION

SHOCK ABSORBER

Nitro Gas Strut - Performance			12716GR	2	\$209.09
Foam Cell Strut - Performance			24716FE	2	\$235.23
Foam Cell Pro Strut - Performance			45716FE	2	\$365.91
Foam Cell Pro Strut - Performance - Long Travel* (SEE NOTE)			45716LFE *	2	\$365.91

*NOTE: MANDATORY FITMENT of Ironman 4x4 UCA048FA is required with Long Travel - Foam Cell Pro

• Height adjustable with Ironman 4x4 Strut Trim Packers

• Foam Cell Pro contains a single adjusting ring for driveshaft clearance

COIL SPRINGS

	Est. Lift	Additional Load			
Standard	0mm	0 - 50kg	NISS040A	1	\$235.23
Light	20mm	0 - 50kg	NISS040B	1	\$235.23
Medium	35mm	0 - 80kg	NISS040C	1	\$235.41
Heavy	40mm	50 - 110kg	NISS040D	1	\$235.23

STRUT MOUNTS

Steel Strut Top			ISST007	2	\$78.41
-----------------	--	--	----------------	---	---------

TRIM PACKERS

5mm Strut Trim Packer	Nitro Gas / Foam Cell	HILFR05 / HILFR05F	2	\$26.14
10mm Strut Trim Packer	Nitro Gas / Foam Cell	HILFR10 / HILFR10F	2	\$26.14
15mm Strut Trim Packer	Nitro Gas / Foam Cell	HILFR15 / HILFR15F	2	\$26.14

• ONLY Compatible with Ironman 4x4 Struts (Except Pro), lift height subject to 2:1 motion ratio. Unnecessary fitment may lift vehicle too high

CONTROL ARMS

Pro-Forge Upper Control Arms			UCA048FA	1	\$831.60
------------------------------	--	--	-----------------	---	----------

REAR SUSPENSION

SHOCK ABSORBER

Nitro Gas - Comfort			12698GRC	2	\$143.75
Nitro Gas - Performance			12698GR	2	\$143.75
Foam Cell - Comfort			24698FEC	2	\$209.09
Foam Cell - Performance			24698FE	2	\$209.09
Foam Cell - Professional			24698FEP	2	\$209.09
Foam Cell Pro - Comfort			45698FEC	2	\$287.50
Foam Cell Pro - Performance			45698FE	2	\$287.50
Foam Cell Pro - Professional			45698FEP	2	\$287.50

LEAF SPRINGS

	Est. Lift	Additional Load			
Medium	40mm	0 - 300kg	NISS057B	2	\$352.84
Heavy	40mm	300kg - GVM	NISS057C	2	\$378.98

U-BOLTS

U-Bolt Kit			1104UBK	2	\$39.21
------------	--	--	----------------	---	---------

POLYURETHANE SPRING BUSHES

Bush Kit			704TUK	1	\$78.41
----------	--	--	---------------	---	---------

GREASABLE SHACKLES AND PINS

Greasable Shackle			797-3	2	\$52.28
-------------------	--	--	--------------	---	---------

HELPER SPRINGS

Load Plus Helper Springs			LP2	1	\$156.82
Add-A-Leaf			ISL6010	1	\$156.82

SUSPENSION KIT

Medium - Nitro Gas		NISS057BKG	\$1803.39
Medium - Foam Cell		NISS057BKF	\$1986.34
Medium - Foam Cell Pro		NISS057BKP	\$2404.52
Heavy - Nitro Gas		NISS057CKG	\$1855.66
Heavy - Foam Cell		NISS057CKF	\$2038.61
Heavy - Foam Cell Pro		NISS057CKP	\$2456.79

• Specify front Coil Springs when ordering

SUSPENSION KIT CONTENTS

Shock Absorbers	Coil Springs	Polyurethane Spring Bushes
Leaf Springs	U-Bolts	



D40
2005+

Nissan Navara

PRODUCT DESCRIPTION

PART NO.

QTY
RequiredRETAIL
ea Incl GST

ACCESSORIES TO SUIT NISSAN NAVARA

STEEL WINCH BULL BARS - RECESSED LINE IN OE BUMPER BAR AND THAI BUILT VEHICLES WITH SMOOTH BUMPER

Commercial Deluxe	BBCD012	\$1985.00
Protector - <i>While Stocks Last</i>	BBT012	\$2009.00

- Can also be fitted to both 2WD and 4WD models.

STEEL WINCH BULL BARS - SMOOTH OE BUMPER BAR EXCEPT THAI BUILT VEHICLES

Commercial Deluxe	BBCD042	\$1985.00
Protector - <i>While Stocks Last</i>	BBT042	\$2009.00

- Can also be fitted to both 2WD and 4WD models.

- STX Spain Built 2010+. - Fits 440(4Cyl) and 550 (V6) Smooth Bumper

STEEL SIDE STEPS AND RAILS - THAI BUILT DUAL CAB MODEL

Side Steps	SS007	\$851.00
Side Steps and Rails	SSR003	\$1022.00

STEEL SIDE STEPS AND RAILS - SPAIN BUILT 2010+ DUAL CAB MODEL

Side Steps	SS042	\$851.00
Side Steps and Rails	SSR042	\$1022.00

RECOVERY POINTS - IRONMAN 4X4 BULL BAR ONLY

Recovery Points - 5000kg Rating (Pair)	IRP005	\$200.00
--	--------	----------

LOCKSAFE DRAWER SYSTEMS

Twin Drawers - 1300mm	ITD1300	\$1469.00
Single Drawer - 1300mm	ISD1300	\$891.00
Wing Kit - 1300mm (ST 2010+)*	ITDW028	\$351.00
Wing Kit - 1300mm (STX, 2006+ Spain built)*	ITDW029	\$351.00

*Designed to suit factory tubs, will not suit ute liner without modification.

SNORKEL

D40 Navara 2005+ - Fits all models except Single Cab	ISNORKEL019	\$387.00
--	-------------	----------

- Not compatible with single cab model.

EXHAUST SYSTEM

BigBore Navara D40 550 1/2011+, V6 Turbo Diesel - <i>While Stocks Last</i>	IEXHAUST012	\$1300.00
--	-------------	-----------

- Fits Automatic Transmission.

LONG RANGE FUEL TANK

Spain Built 145L* Dual Cab - Diesel only	TANK003	\$1129.00
--	---------	-----------

* Usable volume may differ to the stated tank capacity

UNDERBODY PROTECTION

Engine Bay, Radiator* and Transmission	IUP007K	\$562.00
Fuel Tank	IUP007F	\$296.00

* IMPORTANT - Radiator plate ONLY suitable for Spain Built Vehicle. Does not fit vehicles with bull bar fitted.

- Fuel tank protection plates are not compatible with long range fuel tanks.

SEAT COVER

Canvas Comfort - Front	ICSC042F	\$400.00
Canvas Comfort - Rear	ICSC042R	\$400.00

DIFF BREATHER KIT

Diff Breather Kit	IDIFFBRE	\$114.00
-------------------	----------	----------

LISTING
CONTINUED
OVER THE
PAGE





PRODUCT DESCRIPTION

PART NO.

QTY
Required

RETAIL
ea Incl GST

SUSPENSION TO SUIT NISSAN NAVARA

FRONT SUSPENSION

SHOCK ABSORBER

Nitro Gas Strut - Performance			12716GR	2	\$209.09
Foam Cell Strut - Performance			24716FE	2	\$235.23
Foam Cell Pro Strut - Performance			45716FE	2	\$365.91
Foam Cell Pro Strut - Performance - Long Travel* (SEE NOTE)			45716LFE *	2	\$365.91

*NOTE: MANDATORY FITMENT of Ironman 4x4 UCA048FA is required with Long Travel - Foam Cell Pro

• Height adjustable with Ironman 4x4 Strut Trim Packers

• Foam Cell Pro contains a single adjusting ring for driveshaft clearance

COIL SPRINGS

	Est. Lift	Additional Load			
Medium	35mm	0 - 50kg	NISS040C	1	\$235.41
Heavy	35mm	50 - 110kg	NISS040D	1	\$235.23

STRUT MOUNTS

Steel Strut Top			ISST007	2	\$78.41
-----------------	--	--	----------------	---	---------

TRIM PACKERS

5mm Strut Trim Packer	Nitro Gas / Foam Cell	HILFR05 / HILFR05F	2	\$26.14
10mm Strut Trim Packer	Nitro Gas / Foam Cell	HILFR10 / HILFR10F	2	\$26.14
15mm Strut Trim Packer	Nitro Gas / Foam Cell	HILFR15 / HILFR15F	2	\$26.14

• ONLY Compatible with Ironman 4x4 Struts (Except Pro), lift height subject to 2:1 motion ratio. Unnecessary fitment may lift vehicle too high

CONTROL ARMS

Pro-Forge Upper Control Arms			UCA048FA	1	\$831.60
------------------------------	--	--	-----------------	---	----------

REAR SUSPENSION

SHOCK ABSORBER

Nitro Gas - Performance			12717GR	2	\$143.75
Foam Cell - Performance			24717FE	2	\$209.09
Foam Cell - Professional			24717FEP	2	\$209.09
Foam Cell Pro - Performance			45717FE	2	\$287.50
Foam Cell Pro - Professional			45717FEP	2	\$287.50

LEAF SPRINGS

	Est. Lift	Additional Load			
Medium	40mm	0 - 300kg	NISS041B	2	\$352.84
Heavy	40mm	300 - 500kg	NISS041C	2	\$378.98
Extra Heavy	40mm	500kg - GVM	NISS041D	2	\$378.98

U-BOLTS

U-Bolt Kit	Suits NISS041B and NISS041C	437UBK	2	\$39.21
U-Bolt Kit Extra Long	Suits NISS041D	437UBKL	2	\$39.21

POLYURETHANE SPRING BUSHES

Bush Kit		769UK	1	\$78.41
----------	--	--------------	---	---------

GREASABLE SHACKLES AND PINS

Greasable Shackle		797-1	2	\$52.28
-------------------	--	--------------	---	---------

AXLE PROTECTION

ABS Wire and Axle Shield		IAP001	1	\$91.48
--------------------------	--	---------------	---	---------

HELPER SPRINGS

Load Plus Helper Springs		LP2	1	\$156.82
Add-A-Leaf		ISL6010	1	\$156.82

SUSPENSION KIT

Medium - Nitro Gas		NISS041BKG1	\$1803.39
Medium - Foam Cell		NISS041BKF1	\$1986.34
Medium - Foam Cell Pro		NISS041BKP1	\$2404.52
Heavy - Nitro Gas		NISS041CKG1	\$1855.66
Heavy - Foam Cell		NISS041CKF1	\$2038.61
Heavy - Foam Cell Pro		NISS041CKP1	\$2456.79
Extra Heavy - Nitro Gas		NISS041DKG1	\$1855.66
Extra Heavy - Foam Cell		NISS041DKF1	\$2038.61
Extra Heavy - Foam Cell Pro		NISS041DKP1	\$2456.79

• Specify front Coil Springs when ordering

SUSPENSION KIT CONTENTS

Shock Absorbers	Coil Springs	Polyurethane Spring Bushes
Leaf Springs	U-Bolts	Strut Shock Absorbers



D40 (4cyl Diesel and V6 Petrol)
2005+

Nissan Navara

PRODUCT DESCRIPTION

PART NO.

QTY
Required

RETAIL
ea Incl GST

SUSPENSION TO SUIT NISSAN NAVARA

FRONT SUSPENSION

SHOCK ABSORBER

Nitro Gas Strut - Performance			12716GR	2	\$209.09
Foam Cell Strut - Performance			24716FE	2	\$235.23
Foam Cell Pro Strut - Performance			45716FE	2	\$365.91
Foam Cell Pro Strut - Performance - Long Travel* (SEE NOTE)			45716LFE *	2	\$365.91

***NOTE: MANDATORY FITMENT** of Ironman 4x4 UCA048FA is required with Long Travel - Foam Cell Pro

• Height adjustable with Ironman 4x4 Strut Trim Packers

• Foam Cell Pro contains a single adjusting ring for driveshaft clearance

COIL SPRINGS

	Est. Lift	Additional Load			
Medium	35mm	0 - 50kg	NISS040B	1	\$235.23
Heavy	35mm	50 - 110kg	NISS040C	1	\$235.41

STRUT MOUNTS

Steel Strut Top			ISST007	2	\$78.41
-----------------	--	--	----------------	---	---------

TRIM PACKERS

5mm Strut Trim Packer	Nitro Gas / Foam Cell	HILFR05 / HILFR05F	2	\$26.14
10mm Strut Trim Packer	Nitro Gas / Foam Cell	HILFR10 / HILFR10F	2	\$26.14
15mm Strut Trim Packer	Nitro Gas / Foam Cell	HILFR15 / HILFR15F	2	\$26.14

• **ONLY** Compatible with Ironman 4x4 Struts (Except Pro), lift height subject to 2:1 motion ratio. Unnecessary fitment may lift vehicle too high

CONTROL ARMS

Pro-Forge Upper Control Arms			UCA048FA	1	\$831.60
------------------------------	--	--	-----------------	---	----------

REAR SUSPENSION

SHOCK ABSORBER

Nitro Gas - Performance			12717GR	2	\$143.75
Foam Cell - Performance			24717FE	2	\$209.09
Foam Cell - Professional			24717FEP	2	\$209.09
Foam Cell Pro - Performance			45717FE	2	\$287.50
Foam Cell Pro - Professional			45717FEP	2	\$287.50

LEAF SPRINGS

	Est. Lift	Additional Load			
Medium	40mm	0 - 300kg	NISS041B	2	\$352.84
Heavy	40mm	300 - 500kg	NISS041C	2	\$378.98
Extra Heavy	40mm	500kg - GVM	NISS041D	2	\$378.98

U-BOLTS

U-Bolt Kit	Suits NISS041B and NISS041C	437UBK	2	\$39.21
U-Bolt Kit Extra Long	Suits NISS041D	437UBKL	2	\$39.21

POLYURETHANE SPRING BUSHES

Bush Kit		769UK	1	\$78.41
----------	--	--------------	---	---------

GREASABLE SHACKLES AND PINS

Greasable Shackle		797-1	2	\$52.28
-------------------	--	--------------	---	---------

AXLE PROTECTION

ABS Wire and Axle Shield		IAP001	1	\$91.48
--------------------------	--	---------------	---	---------

HELPER SPRINGS

Load Plus Helper Springs		LP2	1	\$156.82
Add-A-Leaf		ISL6010	1	\$156.82

SUSPENSION KIT

Medium - Nitro Gas		NISS041BKG		\$1803.39
Medium - Foam Cell		NISS041BKF		\$1986.34
Medium - Foam Cell Pro		NISS041BKP		\$2404.52
Heavy - Nitro Gas		NISS041CKG		\$1855.66
Heavy - Foam Cell		NISS041CKF		\$2038.61
Heavy - Foam Cell Pro		NISS041CKP		\$2456.79
Extra Heavy - Nitro Gas		NISS041DKG		\$1855.66
Extra Heavy - Foam Cell		NISS041DKF		\$2038.61
Extra Heavy - Foam Cell Pro		NISS041DKP		\$2456.79

• Specify front Coil Springs when ordering

SUSPENSION KIT CONTENTS

Shock Absorbers
Leaf Springs

Coil Springs
U-Bolts

Polyurethane Spring Bushes
Strut Shock Absorbers



Nissan Navara

D22
2002+



PRODUCT DESCRIPTION

PART NO.

QTY
Required

RETAIL
ea Incl GST

ACCESSORIES TO SUIT NISSAN NAVARA

STEEL WINCH BULL BARS

Commercial Deluxe	BBCD013	\$1985.00
Protector - <i>While Stocks Last</i>	BBT013	\$2009.00

• Can also be fitted to both 2WD and 4WD models.

LOCKSAFE DRAWER SYSTEMS

Twin Drawer - 1300mm	ITD1300	\$1469.00
Single Drawer - 1300mm	ISD1300	\$891.00
Wing Kit - 1300mm (2002 to 2007)*	ITDW025	\$351.00
Wing Kit - 1300mm (2007+)*	ITDW026	\$351.00

*Designed to suit factory tubs, will not suit ute liner without modification.

EXHAUST SYSTEM

BigBore D22 Navara 2.5L Diesel Only - <i>While Stocks Last</i>	IEXHAUST011	\$1300.00
--	-------------	-----------

UNDERBODY PROTECTION

Engine Bay and Transmission - Diesel only	IUP006K	\$369.00
---	---------	----------

CANOPY - ABS PLASTIC (SIDE LIFT UP WINDOWS) - FITS 4X4 AND 4X2 DUAL CAB MODELS (FEB 2009 ON)

Pre-Primed	CANOPY007-P	\$3143.00*
------------	-------------	------------

* Pre-primed canopies, plus colour coding.

DIFF BREATHER KIT

Diff Breather Kit	IDIFFBRE	\$114.00
-------------------	----------	----------





D22 / NP300 (Torsion Bar)
1997+

SUSPENSION TO SUIT

Nissan Navara

PRODUCT DESCRIPTION

PART NO.

QTY
Required

RETAIL
ea Incl GST

SUSPENSION TO SUIT NISSAN NAVARA

FRONT SUSPENSION

SHOCK ABSORBER

Nitro Gas - Performance	12791GR	2	\$143.75
-------------------------	----------------	---	----------

• Upper control arm may contact shock absorber, grind away material on control arm for clearance

TORSION BAR

Uprated Torsion Bars	NISS025	1	\$392.04
----------------------	----------------	---	----------

• Minimum 60mm downward suspension travel required after adjustment

REAR SUSPENSION

SHOCK ABSORBER

Nitro Gas - Comfort	12636GRC	2	\$143.75
Nitro Gas - Performance	12636GR	2	\$143.75
Nitro Gas - Professional	12636GRP	2	\$143.75

LEAF SPRINGS

	Est. Lift	Additional Load			
Light - Drivers Side	40mm	0 - 100kg	NISS014AD/S	1	\$352.84
Light - Near Side	40mm	0 - 100kg	NISS014AN/S	1	\$352.84
Medium - Drivers Side	40mm	0 - 250kg	NISS014BD/S	1	\$352.84
Medium - Near Side	40mm	0 - 250kg	NISS014BN/S	1	\$352.84
Heavy - Drivers Side	40mm	250kg - GVM	NISS014CD/S	1	\$378.98
Heavy - Near Side	40mm	250kg - GVM	NISS014CN/S	1	\$378.98

U-BOLTS

U-Bolt Kit	788UBK	2	\$39.21
------------	---------------	---	---------

POLYURETHANE SPRING BUSHES

Bush Kit	704UK	1	\$78.41
----------	--------------	---	---------

GREASABLE SHACKLES AND PINS

Greasable Shackle	797	2	\$65.34
Greasable Pin	798	2	\$26.14

HELPER SPRINGS

Load Plus Helper Springs	LP3	1	\$156.82
Add-A-Leaf	ISL6010	1	\$156.82

SUSPENSION KIT

Light - Nitro Gas	NISS025AKG	\$1829.52
Medium - Nitro Gas	NISS025BKG	\$1829.52
Heavy - Nitro Gas	NISS025CKG	\$1881.80

SUSPENSION KIT CONTENTS

Shock Absorbers	Torsion Bars	Polyurethane Spring Bushes
Leaf Springs	U-Bolts	



Nissan Navara

D21
1985 to 1996



PRODUCT DESCRIPTION

PART NO.

QTY
Required

RETAIL
ea Incl GST

SUSPENSION TO SUIT NISSAN NAVARA

FRONT SUSPENSION

SHOCK ABSORBER

Nitro Gas - Performance	12087GR	2	\$143.75
Foam Cell - Performance	24087FE	2	\$209.09

TORSION BAR

Up-rated Torsion Bars	NISS013	1	\$392.04
-----------------------	----------------	---	----------

• Minimum 60mm downward suspension travel required after adjustment

REAR SUSPENSION

SHOCK ABSORBER

Nitro Gas - Comfort	12636GRC	2	\$143.75
Nitro Gas - Performance	12636GR	2	\$143.75
Nitro Gas - Professional	12636GRP	2	\$143.75
Foam Cell - Comfort	24636FEC	2	\$209.09
Foam Cell - Performance	24636FE	2	\$209.09
Foam Cell - Professional	24636FEP	2	\$209.09

LEAF SPRINGS

	Est. Lift	Additional Load			
Light - Drivers Side	40mm	0 - 100kg	NISS014AD/S	1	\$352.84
Light - Near Side	40mm	0 - 100kg	NISS014AN/S	1	\$352.84
Medium - Drivers Side	40mm	0 - 250kg	NISS014BD/S	1	\$352.84
Medium - Near Side	40mm	0 - 250kg	NISS014BN/S	1	\$352.84
Heavy - Drivers Side	40mm	250kg - GVM	NISS014CD/S	1	\$378.98
Heavy - Near Side	40mm	250kg - GVM	NISS014CN/S	1	\$378.98

U-BOLTS

U-Bolt Kit	788UBK	2	\$39.21
------------	---------------	---	---------

POLYURETHANE SPRING BUSHES

Bush Kit	704UK	1	\$78.41
----------	--------------	---	---------

GREASABLE SHACKLES AND PINS

Greasable Shackle	797	2	\$65.34
Greasable Pin	798	2	\$26.14

HELPER SPRINGS

Load Plus Helper Springs	LP3	1	\$156.82
Add-A-Leaf	ISL6010	1	\$156.82

SUSPENSION KIT

Light - Nitro Gas	NISS014AKG	\$1829.52
Light - Foam Cell	NISS014AKF	\$2090.88
Medium - Nitro Gas	NISS014BKG	\$1829.52
Medium - Foam Cell	NISS014BKF	\$2090.88
Heavy - Nitro Gas	NISS014CKG	\$1855.66
Heavy - Foam Cell	NISS014CKF	\$2117.02

SUSPENSION KIT CONTENTS

Shock Absorbers	Torsion Bars	Polyurethane Spring Bushes
Leaf Springs	U-Bolts	



Pre 2005

Nissan Paladin

PRODUCT DESCRIPTION

PART NO.

QTY
Required

RETAIL
ea Incl GST

SUSPENSION TO SUIT NISSAN PALADIN

FRONT SUSPENSION

SHOCK ABSORBER

Nitro Gas - Performance	12791GR	2	\$143.75
-------------------------	----------------	---	----------

TORSION BAR

Uprated Torsion Bars	NISS048	1	\$392.04
----------------------	----------------	---	----------

• Minimum 60mm downward suspension travel required after adjustment

REAR SUSPENSION

SHOCK ABSORBER

Nitro Gas - Comfort	12698GRC	2	\$143.75
---------------------	-----------------	---	----------

Nitro Gas - Performance	12698GR	2	\$143.75
-------------------------	----------------	---	----------

Foam Cell - Comfort	24698FEC	2	\$209.09
---------------------	-----------------	---	----------

Foam Cell - Performance	24698FE	2	\$209.09
-------------------------	----------------	---	----------

Foam Cell - Professional	24698FEP	2	\$209.09
--------------------------	-----------------	---	----------

LEAF SPRINGS

	Est. Lift	Additional Load		
Medium	40mm	0 - 250kg	NISS049B	2

				2	\$352.84
--	--	--	--	---	----------

U-BOLTS

U-Bolt Kit	654UBK	2	\$39.21
------------	---------------	---	---------

POLYURETHANE SPRING BUSHES

Bush Kit	769UKL	1	\$78.41
----------	---------------	---	---------

GREASABLE SHACKLES AND PINS

Greasable Shackle	797-2	2	\$52.28
-------------------	--------------	---	---------

Greasable Pin	798	2	\$26.14
---------------	------------	---	---------

HELPER SPRINGS

Load Plus Helper Springs	LP2	1	\$156.82
--------------------------	------------	---	----------

Add-A-Leaf	ISL6010	1	\$156.82
------------	----------------	---	----------

SUSPENSION KIT

Medium - Nitro Gas	NISS049BKG		\$1934.07
--------------------	-------------------	--	-----------

SUSPENSION KIT CONTENTS

Shock Absorbers

Shackles

Polyurethane Spring Bushes

Leaf Springs

U-Bolts

Nissan Pathfinder

R51
2005 to 2013



PRODUCT DESCRIPTION

PART NO.

QTY
Required

RETAIL
ea Incl GST

ACCESSORIES TO SUIT NISSAN PATHFINDER

STEEL WINCH BULL BARS - RECESSED LINE IN OE BUMPER BAR AND THAI VEHICLES WITH SMOOTH BUMPER

Commercial Deluxe	BBCD012	\$1985.00
Protector - <i>While Stocks Last</i>	BBT012	\$2009.00

STEEL WINCH BULL BARS - SMOOTH OE BUMPER BAR EXCEPT THAI BUILT VEHICLES

Commercial Deluxe	BBCD042	\$1985.00
Protector - <i>While Stocks Last</i>	BBT042	\$2009.00

• STX Spain Built 2010+ - Fits 2012 V6 model only

SNORKEL

R51 Pathfinder	ISNORKEL019	\$387.00
----------------	-------------	----------

UNDERBODY PROTECTION

Engine	IUP007E	\$199.00
--------	---------	----------

DIFF BREATHER KIT

Diff Breather Kit	IDIFFBRE	\$114.00
-------------------	----------	----------





R51 (V6 Diesel)
7/2005+

Nissan Pathfinder

PRODUCT DESCRIPTION

PART NO.

QTY
Required

RETAIL
ea Incl GST

SUSPENSION TO SUIT NISSAN PATHFINDER

FRONT SUSPENSION

SHOCK ABSORBER

Nitro Gas Strut - Performance			12716GR	2	\$209.09
Foam Cell Strut - Performance			24716FE	2	\$235.23
Foam Cell Pro Strut - Performance			45716FE	2	\$365.91
Foam Cell Pro Strut - Performance - Long Travel* (SEE NOTE)			45716LFE *	2	\$365.91

***NOTE: MANDATORY FITMENT** of Ironman 4x4 UCA048FA is required with Long Travel - Foam Cell Pro

- Height adjustable with Ironman 4x4 Strut Trim Packers
- Foam Cell Pro contains a single adjusting ring for driveshaft clearance

COIL SPRINGS

	Est. Lift	Additional Load			
Medium	35mm	0 - 50kg	NISS040C	1	\$235.41
Heavy	35mm	50 - 110kg	NISS040D	1	\$235.23

STRUT MOUNTS

Steel Strut Top			ISST007	2	\$78.41
-----------------	--	--	----------------	---	---------

TRIM PACKERS

5mm Strut Trim Packer	Nitro Gas / Foam Cell	HILFR05 / HILFR05F	2	\$26.14
10mm Strut Trim Packer	Nitro Gas / Foam Cell	HILFR10 / HILFR10F	2	\$26.14
15mm Strut Trim Packer	Nitro Gas / Foam Cell	HILFR15 / HILFR15F	2	\$26.14

• **ONLY** Compatible with Ironman 4x4 Struts (Except Pro), lift height subject to 2:1 motion ratio. Unnecessary fitment may lift vehicle too high

CONTROL ARMS

Pro-Forge Upper Control Arms			UCA048FA	1	\$831.60
------------------------------	--	--	-----------------	---	----------

REAR SUSPENSION

SHOCK ABSORBER

Nitro Gas - Performance			12718GR	2	\$143.75
Foam Cell - Performance			24718FE	2	\$209.09

COIL SPRINGS

	Est. Lift	Additional Load			
Medium	40mm	0 - 250kg	NISS042B	1	\$235.23
Heavy	40mm	250kg - GVM	NISS042C	1	\$235.23

SUSPENSION KIT

Medium - Nitro Gas	NISS042BKG1	\$1176.12
Medium - Foam Cell	NISS042BKF1	\$1359.08
Heavy - Nitro Gas	NISS042CKG1	\$1176.12
Heavy - Foam Cell	NISS042CKF1	\$1359.08

• Specify front Coil Springs when ordering

SUSPENSION KIT CONTENTS

Shock Absorbers

Strut Shock Absorbers

Coil Springs



stay safe...

practice responsible social distancing!

for a full range of accessories visit our website

www.ironman4x4.com



Nissan Pathfinder

R50
1995 to 7/2005



PRODUCT DESCRIPTION

PART NO.

QTY
Required

RETAIL
ea Incl GST

SUSPENSION TO SUIT NISSAN PATHFINDER

FRONT SUSPENSION

COIL SPRINGS	Est. Lift	Additional Load	PART NO.	QTY	RETAIL
Medium	35mm	0 - 50kg	NISS034B	1	\$235.23
CAMBER CORRECTION					
Camber Bolt Kit			ICAMBER14	1	\$26.14

REAR SUSPENSION

COIL SPRINGS	Est. Lift	Additional Load	PART NO.	QTY	RETAIL
Medium	35mm	0 - 200kg	NISS035B	1	\$235.23





R20 / WD21
Pre 1995

SUSPENSION TO SUIT Nissan Pathfinder / Terrano / II

PRODUCT DESCRIPTION

PART NO.

QTY
Required

RETAIL
ea Incl GST

SUSPENSION TO SUIT NISSAN PATHFINDER / TERRANO / II

FRONT SUSPENSION

SHOCK ABSORBER

Nitro Gas - Performance	12667GR	2	\$143.75
Foam Cell - Performance	24667FE	2	\$209.09

TORSION BAR

Uprated Torsion Bars	NISS017	1	\$392.04
----------------------	---------	---	----------

• Minimum 60mm downward suspension travel required after adjustment

REAR SUSPENSION

SHOCK ABSORBER

Nitro Gas - Comfort	12636GRC	2	\$143.75
Nitro Gas - Performance	12636GR	2	\$143.75
Nitro Gas - Professional	12636GRP	2	\$143.75
Foam Cell - Comfort	24636FEC	2	\$209.09
Foam Cell - Performance	24636FE	2	\$209.09
Foam Cell - Professional	24636FEP	2	\$209.09

COIL SPRINGS

	Est. Lift	Additional Load			
Medium	40mm	0 - 250kg	NISS018B	1	\$235.23
Heavy	40mm	250kg - GVM	HOLD008B	1	\$235.23

SUSPENSION KIT

Medium - Nitro Gas	NISS018BK	\$1202.26
Medium - Foam Cell	NISS018BKF	\$1463.62
Heavy - Nitro Gas	NISS018CK	\$1202.26
Heavy - Foam Cell	NISS018CKF	\$1463.62

SUSPENSION KIT CONTENTS

Shock Absorbers

Coil Springs

Torsion Bars

Nissan Patrol

Y62
2010 to 2019



PRODUCT DESCRIPTION

PART NO.

QTY
Required

RETAIL
ea Incl GST

ACCESSORIES TO SUIT NISSAN PATROL

STEEL WINCH BULL BARS

Premium Commercial Deluxe - 60.3mm Tube
• Does not suit vehicles with Adaptive Cruise Control.

BBP062

\$2136.00

BREATHER KIT

Universal Twin Manifold Filtered Breather Kit

IDIFFBRE

\$114.00



Nissan Patrol

Y62
2010+

PRODUCT DESCRIPTION

PART NO.

QTY
RequiredRETAIL
ea Incl GST

SUSPENSION TO SUIT NISSAN PATROL

FRONT SUSPENSION

SHOCK ABSORBER

Nitro Gas Strut - Performance			12740GR	2	\$209.09
Foam Cell Strut - Performance			24740FE	2	\$235.23
Foam Cell Pro Strut - Performance			45740FE	2	\$365.91

- Height adjustable with Ironman 4x4 Strut Trim Packers

- Non HBMC models only

COIL SPRINGS

	Est. Lift	Additional Load			
Light	30mm	0 - 50kg	NISS045A	1	\$235.23
Medium	40mm	0 - 50kg	NISS045B	1	\$235.23
Heavy	50mm	50 - 110kg	NISS045C	1	\$235.23

TRIM PACKERS

5mm Strut Trim Packer	Nitro Gas / Foam Cell	HILFR05 / HILFR05F	2	\$26.14
10mm Strut Trim Packer	Nitro Gas / Foam Cell	HILFR10 / HILFR10F	2	\$26.14
15mm Strut Trim Packer	Nitro Gas / Foam Cell	HILFR15 / HILFR15F	2	\$26.14

- ONLY Compatible with Ironman 4x4 Struts (except Pro), lift height subject to 2:1 motion ratio. Unnecessary fitment may lift vehicle too high

SWAY BAR

36mm Sway Bar	ISB600F	1	\$548.86
---------------	----------------	---	----------

REAR SUSPENSION

SHOCK ABSORBER

Nitro Gas - Performance		12742GR	2	\$143.75
Foam Cell - Performance		24742FE	2	\$209.09
Foam Cell Pro - Performance		45742FE	2	\$287.50

- Non HBMC models only

COIL SPRINGS

	Est. Lift	Additional Load			
Light	30mm	0 - 300kg	NISS046A	1	\$274.43
Medium	40mm	0 - 300kg	NISS046B	1	\$274.43
Heavy	50mm	300kg - GVM	NISS046C	1	\$274.43

SWAY BAR

27mm Sway Bar	ISB600R	1	\$548.86
---------------	----------------	---	----------

SUSPENSION KIT

Light - Nitro Gas	NISS045AKG	\$1215.33
Light - Foam Cell	NISS045AKF	\$1398.28
Light - Foam Cell Pro	NISS045AKP	\$1816.46
Medium - Nitro Gas	NISS045BKG	\$1215.33
Medium - Foam Cell	NISS045BKF	\$1398.28
Medium - Foam Cell Pro	NISS045BKP	\$1816.46
Heavy - Nitro Gas	NISS045CKG	\$1215.33
Heavy - Foam Cell	NISS045CKF	\$1398.28
Heavy - Foam Cell Pro	NISS045CKP	\$1816.46

- Non HBMC models only

- Mandatory 4 wheel alignment after installing new suspension

- Specify front Coil Springs when ordering

SUSPENSION KIT CONTENTS

Shock Absorbers	Leaf Springs
Strut Shock Absorbers	Coil Springs



PRODUCT DESCRIPTION

PART NO.

QTY
RequiredRETAIL
ea Incl GST

ACCESSORIES TO SUIT NISSAN PATROL

STEEL WINCH BULL BARS

Protector (Coil Spring Only) - <i>While Stocks Last</i>	BBT011	\$2009.00
Premium - 60.3mm Tube	BBP011	\$2098.00

STEEL SIDE STEPS AND RAILS

Side Steps	SS012	\$851.00
Side Steps and Rails	SSR012	\$1022.00
Premium Side Steps and Rails - 60.3mm Tube	SSRP011	\$1129.00

RECOVERY POINTS - IRONMAN 4X4 BULL BAR ONLY

Recovery Points - 5000kg Rating (Pair)	IRP005	\$200.00
--	--------	----------

LOCKSAFE DRAWER SYSTEMS

Twin Drawers - 1000mm	ITD1000	\$1296.00
Single Drawer - 1000mm	ISD1000	\$783.00
Wing Kit - 1000mm (DX, ST, STI)	ITDW011	\$270.00
Wing Kit - 1000mm (STL, Di)	ITDW012	\$270.00

SNORKEL

GU Patrol Series 4	ISNORKELO13	\$387.00
--------------------	-------------	----------

EXHAUST SYSTEM

BigBore GU Patrol 3L Turbo Diesel Wagon (CRD and Di) - <i>While Stocks Last</i>	IEEXHAUST006	\$1300.00
---	--------------	-----------

STEEL ROOF RACKS

Cage Style - 1.4m x 1.25m	IRRCAGE14	\$709.00
Cage Style - 1.8m x 1.25m	IRRCAGE18	\$744.00
Cage Style - 2.2m x 1.25m	IRRCAGE22	\$772.00
Rooftop Tent Compatible - 1.8m x 1.25m	IRRTENT18	\$709.00
Rooftop Tent Compatible - 2.2m x 1.25m	IRRTENT22	\$744.00
Trade Style - 1.8m x 1.25m (Open end)	IRRTRADE18	\$709.00
Trade Style - 2.2m x 1.25m (Open end)	IRRTRADE22	\$738.00

ALLOY ROOF RACKS

Cage Style - 1.4m x 1.25m	IRRCAGE14-ALLOY	\$897.00
Cage Style - 1.8m x 1.25m	IRRCAGE18-ALLOY	\$1049.00
Cage Style - 2.2m x 1.25m	IRRCAGE22-ALLOY	\$1106.00
Trade Style - 1.4m x 1.25m (Open end)	IRROPEN14-ALLOY	\$886.00
Trade Style - 1.8m x 1.25m (Open end)	IRRTRADE18-ALLOY	\$1033.00
Trade Style - 2.2m x 1.25m (Open end)	IRRTRADE22-ALLOY	\$1078.00
Flat Rack - 1.8m x 1.25m	IRRTFLAT18-ALLOY	\$1019.00

ROOF RACK - MOUNTING KITS

Gutter Mount Feet - 100mm (8 Feet)	IRRFEEET100	\$180.00
Gutter Mount Feet - 125mm (8 Feet)	IRRFEEET125	\$180.00

UNDERBODY PROTECTION

Radiator and Transmission • 3.0L and 4.8L only.	IUP015K	\$562.00
--	---------	----------

SEAT COVER

Canvas Comfort - Front	ICSC011F	\$400.00
Canvas Comfort - Rear	ICSC011R	\$400.00
Canvas Comfort - Front Bucket + 3/4 Bench (GU4-GU8 Single Cab DX only)	ICSC011F3/4	\$400.00

DIFF BREATHER KIT

Diff Breather Kit	IDIFFBRE	\$114.00
-------------------	----------	----------

Nissan Patrol

Y61 GU Series 1-3
1998 to 2004

PRODUCT DESCRIPTION

PART NO.

QTY
RequiredRETAIL
ea Incl GST

ACCESSORIES TO SUIT NISSAN PATROL

STEEL WINCH BULL BARS

Commercial Deluxe (Coil Spring Only)

BBCD009

\$1985.00

STEEL SIDE STEPS AND RAILS

Side Steps

SS012

\$851.00

Side Steps and Rails

SSR012

\$1022.00

RECOVERY POINTS - IRONMAN 4X4 BULL BAR ONLY

Recovery Points - 5000kg Rating (Pair)

IRP005

\$200.00

• Series 3-5 only.

LOCKSAFE DRAWER SYSTEMS

Twin Drawers - 1000mm

ITD1000

\$1296.00

Single Drawer - 1000mm

ISD1000

\$783.00

Wing Kit - 1000mm (DX, ST, STI)*

ITDW011

\$270.00

Wing Kit - 1000mm (STL, Di)

ITDW012

\$270.00

SNORKEL

GU Patrol Series 1 2 and 3

ISNORKEL015

\$387.00

EXHAUST SYSTEMBigBore GU Patrol 3L Turbo Diesel Wagon - *While Stocks Last*

IEXHAUST006

\$1300.00

STEEL ROOF RACKS

Cage Style - 1.4m x 1.25m

IRRCAGE14

\$709.00

Cage Style - 1.8m x 1.25m

IRRCAGE18

\$744.00

Cage Style - 2.2m x 1.25m

IRRCAGE22

\$772.00

Rooftop Tent Compatible - 1.8m x 1.25m

IRRTENT18

\$709.00

Rooftop Tent Compatible - 2.2m x 1.25m

IRRTENT22

\$744.00

Trade Style - 1.8m x 1.25m (Open end)

IRRTRADE18

\$709.00

Trade Style - 2.2m x 1.25m (Open end)

IRRTRADE22

\$738.00

ALLOY ROOF RACKS

Cage Style - 1.4m x 1.25m

IRRCAGE14-ALLOY

\$897.00

Cage Style - 1.8m x 1.25m

IRRCAGE18-ALLOY

\$1049.00

Cage Style - 2.2m x 1.25m

IRRCAGE22-ALLOY

\$1106.00

Trade Style - 1.4m x 1.25m (Open end)

IRROPEN14-ALLOY

\$886.00

Trade Style - 1.8m x 1.25m (Open end)

IRRTRADE18-ALLOY

\$1033.00

Trade Style - 2.2m x 1.25m (Open end)

IRRTRADE22-ALLOY

\$1078.00

Flat Rack - 1.8m x 1.25m

IRRTFLAT18-ALLOY

\$1019.00

ROOF RACK - MOUNTING KITS

Gutter Mount Feet - 100mm (8 Feet)

IRRFEET100

\$180.00

Gutter Mount Feet - 125mm (8 Feet)

IRRFEET125

\$180.00

UNDERBODY PROTECTION

Radiator and Transmission

IUP015K

\$562.00

• 3.0L and 4.8L only.

DIFF BREATHER KIT

Diff Breather Kit

IDIFFBRE

\$114.00

LISTING
CONTINUED
OVER THE
PAGE



PRODUCT DESCRIPTION

PART NO.

QTY
RequiredRETAIL
ea Incl GST

SUSPENSION TO SUIT NISSAN PATROL

FRONT SUSPENSION

SHOCK ABSORBER

Nitro Gas - Performance			12091GR	2	\$143.75
Foam Cell - Performance			24091FE	2	\$209.09
Foam Cell - Professional			24091FEP	2	\$209.09
Foam Cell - Performance	Suits 4" Lift		24091LFE	2	\$235.23
Foam Cell - Performance	Suits 6" Lift		24091LFE1	2	\$261.36
Foam Cell Pro - Performance			45091FE	2	\$287.50
Foam Cell Pro - Professional			45091FEP	2	\$287.50
Foam Cell Pro - Performance	Suits 4" Lift		45091LFE	2	\$300.57
Foam Cell Pro - Professional	Suits 4" Lift		45091LFEP	2	\$300.57
Foam Cell Pro - Performance	Suits 6" Lift		45091LFE1	2	\$313.64

COIL SPRINGS

	Est. Lift	Additional Load			
Medium	50mm	0 - 50kg	NISS024B	1	\$235.23
Medium - 4" Lift	100mm	0 - 100kg	NISS026B	1	\$365.91
Medium - 6" Lift	150mm	0 - 100kg	NISS043B	1	\$431.25
Heavy	50mm	50 - 110kg	NISS009C	1	\$235.23

STEERING DAMPER

Foam Cell	Pre 2/2000		3511	1	\$156.82
Foam Cell	2/2000+		3501	1	\$156.82

CASTER CORRECTION

2° Offset Bush Kit - Polyurethane			1144SK	1	\$143.75
2° Offset Bush Kit - Rubber			1144RK	1	\$143.75
5° Offset Plate Kit			CPLATE003	1	\$209.09
Radius Arm Spacer	15mm		833WT	1	\$78.41
4° Drop Box			DBOX003	1	\$365.91

STEERING RODS

Adjustable Drag Link			ADL005	1	\$457.38
Track Rod			ATR005	1	\$457.38

ADJUSTABLE PANHARD ROD

Right Hand Drive Rod	Pre 2/2000		PANHARD003	1	\$300.57
Left Hand Drive Rod	Pre 2/2000		PANHARD008	1	\$300.57
Right Hand Drive Rod	2/2000+		PANHARD005	1	\$313.64
Left Hand Drive Rod	2/2000+		PANHARD009	1	\$313.64

SWAY BAR LINK

Extended Sway Bar Link	Suits 1-3" Lift		SBEXT006	2	\$78.41
Extended Sway Bar Link	Suits 4-7" Lift		SBEXT003	2	\$78.41

COIL SPACER

Polyurethane 15mm	Provides 10mm Lift		PATF15	2	\$26.14
Polyurethane 30mm	Provides 25mm Lift		PATF30	2	\$39.21

BRAKE HOSE

Extended Brake Hose	Non ABS Models		BHOSE003	1	\$65.34
Extended Brake Hose	ABS models		BHOSE005	2	\$65.34



Y61 GU LWB Wagon

Nissan Patrol

PRODUCT DESCRIPTION

PART NO.

QTY
RequiredRETAIL
ea Incl GST

REAR SUSPENSION

SHOCK ABSORBER

Nitro Gas - Performance			12094GR	2	\$143.75
Foam Cell - Performance			24094FE	2	\$209.09
Foam Cell - Professional			24094FEP	2	\$209.09
Foam Cell - Performance	Suits 4" Lift		24094LFE	2	\$235.23
Foam Cell - Professional	Suits 4" Lift		24094LFEP	2	\$235.23
Foam Cell - Performance	Suits 6" Lift		24094LFE1	2	\$261.36
Foam Cell Pro - Performance			45094FE	2	\$287.50
Foam Cell Pro - Professional			45094FEP	2	\$287.50
Foam Cell Pro - Performance	Suits 4" Lift		45094LFE	2	\$300.57
Foam Cell Pro - Professional	Suits 4" Lift		45094LFEP	2	\$300.57
Foam Cell Pro - Performance	Suits 6" Lift		45094LFE1	2	\$313.64

COIL SPRINGS

	Est. Lift	Additional Load			
Medium	50mm	0 - 200kg	NISS010C	1	\$248.30
Medium - 4" Lift	100mm	0 - 300kg	NISS027B	1	\$365.91
Medium - 6" Lift	150mm	0 - 300kg	NISS044B	1	\$431.25
Heavy	50mm	200 - 400kg	NISS020C	1	\$261.36
Heavy - 4" Lift	100mm	400kg - GVM	NISS027C	1	\$365.91
Heavy - 6" Lift	150mm	400kg - GVM	NISS044C	1	\$431.25
Extra Heavy	50mm	400kg - GVM	NISS020D	1	\$392.04

PANHARD ROD

Adjustable Panhard Rod	Pre 2/2000		PANHARD004	1	\$300.57
Adjustable Panhard Rod	2/2000+		PANHARD006	1	\$313.64

ADJUSTABLE TRAILING ARM

Upper Trailing Arm			UTA003	2	\$196.02
Lower Trailing Arm			LTA003	2	\$248.30

SWAY BAR LINK

Extended Sway Bar Link	Suits 1-3" Lift	Right Side	SBEXT006	1	\$78.41
Extended Sway Bar Link	Suits 4-7" Lift	Right Side	SBEXT003	1	\$78.41
Extended Sway Bar Link	Suits 1-3" Lift	Left Side	SBEXT007	1	\$78.41
Extended Sway Bar Link	Suits 4-7" Lift	Left Side	SBEXT004	1	\$78.41

COIL SPACER

Polyurethane 15mm	Provides 10mm Lift		PATR15	2	\$26.14
Polyurethane 30mm	Provides 25mm Lift		PATR30	2	\$39.21

BRAKE HOSE

Extended Brake Hose			BHOSE004	1	\$65.34
---------------------	--	--	-----------------	---	---------

BRACKET KIT

Coil Drop Out Cone			IDOC003	1	\$235.23
Coil Retainer Kit			ICR003	1	\$117.62

BUSH KIT

Rubber Suspension Arm Bush Kit - Pre 2/2000	W/ Standard Radius Arm Bushes		839RK	1	\$378.98
Rubber Suspension Arm Bush Kit - Pre 2/2000	W/ Offset Radius Arm Bushes		839CRK	1	\$378.98
Rubber Suspension Arm Bush Kit - 2/2000+	W/ Standard Radius Arm Bushes		848RK	1	\$405.11
Rubber Suspension Arm Bush Kit - 2/2000+	W/ Offset Radius Arm Bushes		848CRK	1	\$405.11

 LISTING
CONTINUED
OVER THE
PAGE

Nissan Patrol

Y61 GU LWB Wagon



PRODUCT DESCRIPTION

PART NO.

QTY
Required

RETAIL
ea Incl GST

SUSPENSION KIT

Medium - Nitro Gas			NISS024CKG	\$1058.51
Medium - Foam Cell			NISS024CKF	\$1319.87
Medium - Foam Cell	4"Lift	RHD - Pre 2/2000	NISS026BKF	\$3815.86
Medium - Foam Cell	4"Lift	LHD - Pre 2/2000	NISS026BKFL	\$3815.86
Medium - Foam Cell	6"Lift	RHD - Pre 2/2000	NISS043BKF	\$4051.08
Medium - Foam Cell	6"Lift	LHD - Pre 2/2000	NISS043BKFL	\$4051.08
Medium - Foam Cell	4"Lift	RHD - 2/2000+	NISS026BKF1	\$3842.00
Medium - Foam Cell	4"Lift	LHD - 2/2000+	NISS026BKF1L	\$3842.00
Medium - Foam Cell	6"Lift	RHD - 2/2000+	NISS043BKF1	\$4077.22
Medium - Foam Cell	6"Lift	LHD - 2/2000+	NISS043BKFL1	\$4077.22
Medium - Foam Cell Pro			NISS024CKP	\$1633.50
Medium - Foam Cell Pro	4"Lift	RHD - Pre 2/2000	NISS026BKP	\$4077.22
Medium - Foam Cell Pro	4"Lift	LHD - Pre 2/2000	NISS026BKPL	\$4077.22
Medium - Foam Cell Pro	6"Lift	RHD - Pre 2/2000	NISS043BKP	\$4260.17
Medium - Foam Cell Pro	6"Lift	LHD - Pre 2/2000	NISS043BKPL	\$4260.17
Medium - Foam Cell Pro	4"Lift	RHD - 2/2000+	NISS026BKP1	\$4103.36
Medium - Foam Cell Pro	4"Lift	LHD - 2/2000+	NISS026BKP1L	\$4103.36
Medium - Foam Cell Pro	6"Lift	RHD - 2/2000+	NISS043BKP1	\$4286.31
Medium - Foam Cell Pro	6"Lift	LHD - 2/2000+	NISS043BKP1L	\$4286.31
Heavy - Nitro Gas			NISS037CKG	\$1071.58
Heavy - Foam Cell			NISS037CKF	\$1332.94
Heavy - Foam Cell	4"Lift	RHD - Pre 2/2000	NISS026CKF	\$3815.86
Heavy - Foam Cell	6"Lift	RHD - Pre 2/2000	NISS043CKF	\$4051.08
Heavy - Foam Cell	4"Lift	RHD - 2/2000+	NISS026CKF1	\$3842.00
Heavy - Foam Cell	6"Lift	RHD - 2/2000+	NISS043CKF1	\$4077.22
Heavy - Foam Cell Pro			NISS037CKP	\$1646.57
Heavy - Foam Cell Pro	4"Lift	RHD - Pre 2/2000	NISS026CKP	\$4077.22
Heavy - Foam Cell Pro	6"Lift	RHD - Pre 2/2000	NISS043CKP	\$4260.17
Heavy - Foam Cell Pro	4"Lift	RHD - 2/2000+	NISS026CKP1	\$4103.36
Heavy - Foam Cell Pro	6"Lift	RHD - 2/2000+	NISS043CKP1	\$4286.31
Extra Heavy - Nitro Gas			NISS037DKG	\$1202.26
Extra Heavy - Foam Cell			NISS037DKF	\$1463.62
Extra Heavy - Foam Cell Pro			NISS037DKP	\$1777.25

• Specify ABS / non-ABS brake hoses when ordering suspension kits

• 4" and 6" lifts may not be legal for on-road use in your area, certification may be required for on-road use

• Due to the extreme nature of 4" and 6" lifts, further modifications may be required, and will vary between vehicles, such modifications are entirely the owners responsibility

Ironman 4x4 accept no responsibility for any damage or injury caused by use of the these products

50MM SUSPENSION KIT CONTENTS

Shock Absorbers Coil Springs

4" AND 6" SUSPENSION KIT CONTENTS

Shock Absorbers Caster Plates
Coil Springs Brake Hoses
Panhard Rods Adjustable Trailing Arms
Sway Bar Links





No matter where you are, or where you go!

for a full range of accessories visit our website

www.ironman4x4.com



Nissan Patrol

Y60 GQ / Y61 GU
Cab Chassis (Coil/Coil)



PRODUCT DESCRIPTION

PART NO.

QTY
Required

RETAIL
ea Incl GST

SUSPENSION TO SUIT NISSAN PATROL

FRONT SUSPENSION

SHOCK ABSORBER

Nitro Gas - Performance			12091GR	2	\$143.75
Foam Cell - Performance			24091FE	2	\$209.09
Foam Cell - Professional			24091FEP	2	\$209.09
Foam Cell - Performance	Suits 4" Lift		24091LFE	2	\$235.23
Foam Cell - Performance	Suits 6" Lift		24091LFE1	2	\$261.36
Foam Cell Pro - Performance			45091FE	2	\$287.50
Foam Cell Pro - Professional			45091FEP	2	\$287.50
Foam Cell Pro - Performance	Suits 4" Lift		45091LFE	2	\$300.57
Foam Cell Pro - Professional	Suits 4" Lift		45091LFEP	2	\$300.57
Foam Cell Pro - Performance	Suits 6" Lift		45091LFE1	2	\$313.64

COIL SPRINGS

	Est. Lift	Additional Load			
Medium	50mm	0 - 50kg	NISS024B	1	\$235.23
Heavy	50mm	50 - 110kg	NISS009C	1	\$235.23
Medium - 4" Lift	100mm	0 - 100kg	NISS026B	1	\$365.91
Medium - 6" Lift	150mm	0 - 100kg	NISS043B	1	\$431.25

STEERING DAMPER

Foam Cell			3511	1	\$156.82
-----------	--	--	-------------	---	----------

CASTER CORRECTION

2° Offset Bush Kit - Polyurethane			1144SK	1	\$143.75
2° Offset Bush Kit - Rubber			1144RK	1	\$143.75
5° Offset Plate Kit			CPLATE003	1	\$209.09
Radius Arm Spacer	15mm		833WT	1	\$78.41
4° Drop Box			DBOX003	1	\$365.91

STEERING RODS

Adjustable Drag Link			ADL003	1	\$457.38
Track Rod			ATR003	1	\$457.38

ADJUSTABLE PANHARD ROD

Right Hand Drive Rod			PANHARD003	1	\$300.57
Left Hand Drive Rod			PANHARD008	1	\$300.57

SWAY BAR LINK

Extended Sway Bar Link	Suits 1-3" Lift		SBEXT006	2	\$78.41
Extended Sway Bar Link	Suits 4-7" Lift		SBEXT003	2	\$78.41

COIL SPACER

Polyurethane 15mm	Provides 10mm Lift		PATF15	2	\$26.14
Polyurethane 30mm	Provides 25mm Lift		PATF30	2	\$39.21

BRAKE HOSE

Extended Brake Hose	Non ABS Models		BHOSE003	1	\$65.34
Extended Brake Hose	ABS models		BHOSE005	2	\$65.34



Y60 GQ / Y61 GU
Cab Chassis (Coil/Coil)

SUSPENSION TO SUIT

Nissan Patrol

PRODUCT DESCRIPTION

PART NO.

QTY
Required

RETAIL
ea Incl GST

REAR SUSPENSION

SHOCK ABSORBER

Nitro Gas - Performance			12094GR	2	\$143.75
Foam Cell - Performance			24094FE	2	\$209.09
Foam Cell - Professional			24094FEP	2	\$209.09
Foam Cell - Performance	Suits 4" Lift		24094LFE	2	\$235.23
Foam Cell - Professional	Suits 4" Lift		24094LFEP	2	\$235.23
Foam Cell - Performance	Suits 6" Lift		24094LFE1	2	\$261.36
Foam Cell Pro - Performance			45094FE	2	\$287.50
Foam Cell Pro - Professional			45094FEP	2	\$287.50
Foam Cell Pro - Performance	Suits 4" Lift		45094LFE	2	\$300.57
Foam Cell Pro - Professional	Suits 4" Lift		45094LFEP	2	\$300.57
Foam Cell Pro - Performance	Suits 6" Lift		45094LFE1	2	\$313.64

COIL SPRINGS

	Est. Lift	Additional Load			
Medium	50mm	0 - 300kg	NISS020B	1	\$248.30
Medium - 4" Lift	100mm	0 - 300kg	NISS027B	1	\$365.91
Medium - 6" Lift	150mm	0 - 300kg	NISS044B	1	\$431.25
Heavy	50mm	300 - 400kg	NISS020C	1	\$261.36
Heavy - 4" Lift	100mm	400kg - GVM	NISS027C	1	\$365.91
Heavy - 6" Lift	150mm	400kg - GVM	NISS044C	1	\$431.25
Extra Heavy	50mm	400kg - GVM	NISS020D	1	\$392.04

PANHARD ROD

Adjustable Panhard Rod			PANHARD004	1	\$300.57
------------------------	--	--	-------------------	---	----------

ADJUSTABLE TRAILING ARM

Upper Trailing Arm			UTA003	2	\$196.02
Lower Trailing Arm			LTA003	2	\$248.30

SWAY BAR LINK

Extended Sway Bar Link	Suits 1-3" Lift	Right Side	SBEXT006	1	\$78.41
Extended Sway Bar Link	Suits 4-7" Lift	Right Side	SBEXT003	1	\$78.41
Extended Sway Bar Link	Suits 1-3" Lift	Left Side	SBEXT007	1	\$78.41
Extended Sway Bar Link	Suits 4-7" Lift	Left Side	SBEXT004	1	\$78.41

COIL SPACER

Polyurethane 15mm	Provides 10mm Lift		PATR15	2	\$26.14
Polyurethane 30mm	Provides 25mm Lift		PATR30	2	\$39.21

BRAKE HOSE

Extended Brake Hose			BHOSE004	1	\$65.34
---------------------	--	--	-----------------	---	---------

BRACKET KIT

Coil Drop Out Cone			IDOC003	1	\$235.23
Coil Retainer Kit			ICR003	1	\$117.62

BUSH KIT

Rubber Suspension Arm Bush Kit	W/ Standard Radius Arm Bushes		839RK	1	\$378.98
Rubber Suspension Arm Bush Kit	W/ Offset Radius Arm Bushes		839CRK	1	\$378.98

LISTING
CONTINUED
OVER THE
PAGE



Nissan Patrol

Y60 GQ / Y61 GU
Cab Chassis (Coil/Coil)



PRODUCT DESCRIPTION

PART NO.

QTY
Required

RETAIL
ea Incl GST

SUSPENSION KIT

Medium - Nitro Gas			NISS037BKG	\$1058.51
Medium - Foam Cell			NISS037BKF	\$1319.87
Medium - Foam Cell	4" Lift	RHD	NISS026BKF	\$3815.86
Medium - Foam Cell	4" Lift	LHD	NISS026BKFL	\$3815.86
Medium - Foam Cell	6" Lift	RHD	NISS043BKF	\$4051.08
Medium - Foam Cell	6" Lift	LHD	NISS043BKFL	\$4051.08
Medium - Foam Cell Pro			NISS037BKP	\$1633.50
Medium - Foam Cell Pro	4" Lift	RHD	NISS026BKP	\$4077.22
Medium - Foam Cell Pro	4" Lift	LHD	NISS026BKPL	\$4077.22
Medium - Foam Cell Pro	6" Lift	RHD	NISS043BKP	\$4260.17
Medium - Foam Cell Pro	6" Lift	LHD	NISS043BKPL	\$4260.17
Heavy - Nitro Gas			NISS037CKG	\$1071.58
Heavy - Foam Cell			NISS037CKF	\$1332.94
Heavy - Foam Cell	4" Lift	RHD	NISS026CKF	\$3815.86
Heavy - Foam Cell	4" Lift	LHD	NISS026CKFL	\$3815.86
Heavy - Foam Cell	6" Lift	RHD	NISS043CKF	\$4051.08
Heavy - Foam Cell	6" Lift	LHD	NISS043CKFL	\$4051.08
Heavy - Foam Cell Pro			NISS037CKP	\$1646.57
Heavy - Foam Cell Pro	4" Lift	RHD	NISS026CKP	\$4077.22
Heavy - Foam Cell Pro	4" Lift	LHD	NISS026CKPL	\$4077.22
Heavy - Foam Cell Pro	6" Lift	RHD	NISS043CKP	\$4260.17
Heavy - Foam Cell Pro	6" Lift	LHD	NISS043CKPL	\$4260.17
Extra Heavy - Nitro Gas			NISS037DKG	\$1202.26
Extra Heavy - Foam Cell			NISS037DKF	\$1463.62
Extra Heavy - Foam Cell Pro			NISS037DKP	\$1777.25

• Specify ABS / non-ABS brake hoses when ordering suspension kits

• 4" and 6" lifts may not be legal for on-road use in your area, certification may be required for on-road use

• Due to the extreme nature of 4" and 6" lifts, further modifications may be required, and will vary between vehicles

Such modifications are entirely the owners responsibility. Ironman 4x4 accept no responsibility for any damage or injury caused by use of the these products

50MM SUSPENSION KIT CONTENTS

Shock Absorbers Coil Springs

4" AND 6" SUSPENSION KIT CONTENTS

Shock Absorbers Caster Plates
Coil Springs Brake Hoses
Panhard Rods Adjustable Trailing Arms
Sway Bar Links

Nissan Patrol



Y60 GQ / Y61 GU
Cab Chassis (Coil/Leaf)

PRODUCT DESCRIPTION

PART NO.

QTY
RequiredRETAIL
ea Incl GST

SUSPENSION TO SUIT NISSAN PATROL

FRONT SUSPENSION

SHOCK ABSORBER

Nitro Gas - Performance			12091GR	2	\$143.75
Foam Cell - Performance			24091FE	2	\$209.09
Foam Cell Pro - Performance			45091FE	2	\$287.50
Foam Cell Pro - Professional			45091FEP	2	\$287.50

COIL SPRINGS

	Est. Lift	Additional Load			
Medium	50mm	0 - 50kg	NISS024B	1	\$235.23
Heavy	50mm	50 - 110kg	NISS009C	1	\$235.23

STEERING DAMPER

Foam Cell			3511	1	\$156.82
-----------	--	--	------	---	----------

CASTER CORRECTION

2° Offset Bush Kit - Polyurethane			1144SK	1	\$143.75
2° Offset Bush Kit - Rubber			1144RK	1	\$143.75
5° Offset Plate Kit			CPLATE003	1	\$209.09
Radius Arm Spacer		15mm	833WT	1	\$78.41
4° Drop Box			DBOX003	1	\$365.91

CROSSMEMBER SPACER

6mm / 12mm Spacer Kit			1002K	1	\$91.48
-----------------------	--	--	-------	---	---------

STEERING RODS

Adjustable Drag Link			ADL003	1	\$457.38
Track Rod			ATR003	1	\$457.38

ADJUSTABLE PANHARD ROD

Right Hand Drive Rod			PANHARD003	1	\$300.57
Left Hand Drive Rod			PANHARD008	1	\$300.57

SWAY BAR LINK

Extended Sway Bar Link		Suits 1-3" Lift	SBEXT006	2	\$78.41
------------------------	--	-----------------	----------	---	---------

COIL SPACER

Polyurethane 15mm		Provides 10mm Lift	PATF15	2	\$26.14
Polyurethane 30mm		Provides 25mm Lift	PATF30	2	\$39.21

BRAKE HOSE

Extended Brake Hose			BHOSE003	1	\$65.34
---------------------	--	--	----------	---	---------

REAR SUSPENSION

SHOCK ABSORBER

Nitro Gas - Performance			12648GR	2	\$143.75
Foam Cell - Performance			24648FE	2	\$209.09
Foam Cell Pro - Performance			45648FE	2	\$287.50

LEAF SPRINGS

	Est. Lift	Additional Load			
Heavy - Drivers Side	50mm	0 - 400kg	NISS012CD/S	1	\$496.59
Heavy - Near Side	50mm	0 - 400kg	NISS012CN/S	1	\$496.59
Extra Heavy - Drivers Side	50mm	400kg - GVM	NISS012DD/S	1	\$575.00
Extra Heavy - Near Side	50mm	400kg - GVM	NISS012DN/S	1	\$575.00

U-BOLTS

U-Bolt Kit			1100UBK	2	\$39.21
U-Bolt Kit		Suits NISS012D	1100UBKL	2	\$39.21

POLYURETHANE SPRING BUSHES

Bush Kit			719UK	1	\$65.34
----------	--	--	-------	---	---------

GREASABLE SHACKLES AND PINS

Greasable Shackle		Left Hand Side	353LH	1	\$65.34
Greasable Shackle		Right Hand Side	353RH	1	\$65.34
Greasable Pin			667	2	\$39.21

HELPER SPRINGS

Load Plus Helper Springs			LP4	1	\$156.82
--------------------------	--	--	-----	---	----------

SUSPENSION KIT

Heavy - Nitro Gas			NISS036CKG		\$1947.14
Heavy - Foam Cell			NISS036CKF		\$2208.50
Heavy - Foam Cell Pro			NISS036CKP		\$2522.13
Extra Heavy - Nitro Gas			NISS036DKG		\$2025.54
Extra Heavy - Foam Cell			NISS036DKF		\$2286.90
Extra Heavy - Foam Cell Pro			NISS036DKP		\$2678.94

SUSPENSION KIT CONTENTS

Shock Absorbers	Leaf Springs	Polyurethane Spring Bushes
Coil Springs	U-Bolts	



Nissan Patrol

Y60 GQ Station Wagon and Coil Cab
1987 to 1997



PRODUCT DESCRIPTION

PART NO.

QTY
Required

RETAIL
ea Incl GST

ACCESSORIES TO SUIT NISSAN PATROL

STEEL WINCH BULL BARS

Commercial Deluxe BBCD010 \$1985.00

LOCKSAFE DRAWER SYSTEMS

Twin Drawers - 1000mm ITD1000 \$1296.00

Single Drawer - 1000mm ISD1000 \$783.00

SNORKEL

All Models Except 2.8L Diesel ISNORKELO11 \$387.00

STEEL ROOF RACKS

Cage Style - 1.4m x 1.25m IRRCAGE14 \$709.00

Cage Style - 1.8m x 1.25m IRRCAGE18 \$744.00

Cage Style - 2.2m x 1.25m IRRCAGE22 \$772.00

Rooftop Tent Compatible - 1.8m x 1.25m IRRTENT18 \$709.00

Rooftop Tent Compatible - 2.2m x 1.25m IRRTENT22 \$744.00

Trade Style - 1.8m x 1.25m (Open end) IRRTRADE18 \$709.00

Trade Style - 2.2m x 1.25m (Open end) IRRTRADE22 \$738.00

ALLOY ROOF RACKS

Cage Style - 1.4m x 1.25m IRRCAGE14-ALLOY \$897.00

Cage Style - 1.8m x 1.25m IRRCAGE18-ALLOY \$1049.00

Cage Style - 2.2m x 1.25m IRRCAGE22-ALLOY \$1106.00

Trade Style - 1.4m x 1.25m (Open end) IRROPEN14-ALLOY \$886.00

Trade Style - 1.8m x 1.25m (Open end) IRRTRADE18-ALLOY \$1033.00

Trade Style - 2.2m x 1.25m (Open end) IRRTRADE22-ALLOY \$1078.00

Flat Rack - 1.8m x 1.25m IRRTFLAT18-ALLOY \$1019.00

ROOF RACK - MOUNTING KITS

Gutter Mount Feet - 125mm (8 Feet - Does not fit high roof model) IRRFEET125 \$180.00

Gutter Mount Feet - 210mm (8 Feet - Fits high roof model) IRRFEET210 \$199.00

DIFF BREATHER KIT

Diff Breather Kit IDIFFBRE \$114.00



Nissan Patrol

Y60 GQ Cab Chassis (Leaf/Leaf)
1988+

PRODUCT DESCRIPTION

PART NO.

QTY
RequiredRETAIL
ea Incl GST

SUSPENSION TO SUIT NISSAN PATROL

FRONT SUSPENSION

SHOCK ABSORBER

Nitro Gas - Performance			12661GR	2	\$143.75
Foam Cell - Performance			24661FE	2	\$209.09
Foam Cell Pro - Performance			45661FE	2	\$287.50

LEAF SPRINGS

	Est. Lift	Additional Load			
Heavy - Drivers Side	50mm	0 - 110kg	NISS011CD/S	1	\$378.98
Heavy - Near Side	50mm	0 - 110kg	NISS011CN/S	1	\$378.98

STEERING DAMPER

Foam Cell			3522	1	\$156.82
-----------	--	--	-------------	---	----------

U-BOLTS

Drivers Side U-Bolt Kit			669UBK	1	\$39.21
Near Side U-Bolt Kit			436UBK	1	\$39.21

POLYURETHANE SPRING BUSHES

Bush Kit			718UK	1	\$65.34
----------	--	--	--------------	---	---------

GREASABLE SHACKLES AND PINS

Greasable Shackle	Left Hand Side		353RH	1	\$65.34
Greasable Shackle	Right Hand Side		353LH	1	\$65.34
Greasable Pin			667	2	\$39.21

REAR SUSPENSION

SHOCK ABSORBER

Nitro Gas - Performance			12648GR	2	\$143.75
Foam Cell - Performance			24648FE	2	\$209.09
Foam Cell Pro - Performance			45648FE	2	\$287.50

LEAF SPRINGS

	Est. Lift	Additional Load			
Heavy - Drivers Side	50mm	0 - 400kg	NISS012CD/S	1	\$496.59
Heavy - Near Side	50mm	0 - 400kg	NISS012CN/S	1	\$496.59
Extra Heavy - Drivers Side	50mm	400kg - GVM	NISS012DD/S	1	\$575.00
Extra Heavy - Near Side	50mm	400kg - GVM	NISS012DN/S	1	\$575.00

U-BOLTS

U-Bolt Kit			670UBK	2	\$39.21
------------	--	--	---------------	---	---------

POLYURETHANE SPRING BUSHES

Bush Kit			719UK	1	\$65.34
----------	--	--	--------------	---	---------

GREASABLE SHACKLES AND PINS

Greasable Shackle	Left Hand Side		353LH	1	\$65.34
Greasable Shackle	Right Hand Side		353RH	1	\$65.34
Greasable Pin			667	2	\$39.21

HELPER SPRINGS

Load Plus Helper Springs			LP4	1	\$156.82
--------------------------	--	--	------------	---	----------

SUSPENSION KIT

Heavy - Nitro Gas	NISS011CKG	\$2613.60
Heavy - Foam Cell	NISS011CKF	\$2874.96
Heavy - Foam Cell Pro	NISS011CKP	\$3188.60
Extra Heavy - Nitro Gas	NISS011DKG	\$2692.01
Extra Heavy - Foam Cell	NISS011DKF	\$2953.37
Extra Heavy - Foam Cell Pro	NISS011DKP	\$3345.41

SUSPENSION KIT CONTENTS

Shock Absorbers	U-Bolts
Leaf Springs	Polyurethane Spring Bushes



PRODUCT DESCRIPTION

PART NO.

QTY
Required

RETAIL
ea Incl GST

SUSPENSION TO SUIT NISSAN PATROL

FRONT SUSPENSION

SHOCK ABSORBER

Nitro Gas - Performance			12091GR	2	\$143.75
Foam Cell - Performance			24091FE	2	\$209.09
Foam Cell - Professional			24091FEP	2	\$209.09
Foam Cell - Performance	Suits 4" Lift		24091LFE	2	\$235.23
Foam Cell - Performance	Suits 6" Lift		24091LFE1	2	\$261.36
Foam Cell Pro - Performance			45091FE	2	\$287.50
Foam Cell Pro - Professional			45091FEP	2	\$287.50
Foam Cell Pro - Performance	Suits 4" Lift		45091LFE	2	\$300.57
Foam Cell Pro - Professional	Suits 4" Lift		45091LFEP	2	\$300.57
Foam Cell Pro - Performance	Suits 6" Lift		45091LFE1	2	\$313.64

COIL SPRINGS

	Est. Lift	Additional Load			
Medium	50mm	0 - 50kg	NISS009B	1	\$235.23
Heavy	50mm	50 - 110kg	NISS009C	1	\$235.23
Medium - 4" Lift	100mm	0 - 100kg	NISS026B	1	\$365.91
Medium - 6" Lift	150mm	0 - 100kg	NISS043B	1	\$431.25

STEERING DAMPER

Foam Cell	Pre 8/1989	3534	1	\$156.82
Foam Cell	8/1989+	3536	1	\$156.82

CASTER CORRECTION

2° Offset Bush Kit - Polyurethane		1144SK	1	\$143.75
2° Offset Bush Kit - Rubber		1144RK	1	\$143.75
5° Offset Plate Kit		CPLATE003	1	\$209.09
Radius Arm Spacer	15mm	833WT	1	\$78.41
4° Drop Box		DBOX003	1	\$365.91

CROSSMEMBER SPACER

6mm / 12mm Spacer Kit		1002K	1	\$91.48
-----------------------	--	--------------	---	---------

STEERING RODS

Adjustable Drag Link		ADL003	1	\$457.38
Track Rod		ATR003	1	\$457.38

ADJUSTABLE PANHARD ROD

Right Hand Drive Rod		PANHARD003	1	\$300.57
Left Hand Drive Rod		PANHARD008	1	\$300.57

SWAY BAR LINK

Extended Sway Bar Link	Suits 1-3" Lift	SBEXT006	2	\$78.41
Extended Sway Bar Link	Suits 4-7" Lift	SBEXT003	2	\$78.41

COIL SPACER

Polyurethane 15mm	Provides 10mm Lift	PATF15	2	\$26.14
Polyurethane 30mm	Provides 25mm Lift	PATF30	2	\$39.21

BRAKE HOSE

Extended Brake Hose		BHOSE003	1	\$65.34
---------------------	--	-----------------	---	---------

REAR SUSPENSION

SHOCK ABSORBER

Nitro Gas - Performance			12094GR	2	\$143.75
Foam Cell - Performance			24094FE	2	\$209.09
Foam Cell - Professional			24094FEP	2	\$209.09
Foam Cell - Performance	Suits 4" Lift		24094LFE	2	\$235.23
Foam Cell - Professional	Suits 4" Lift		24094LFEP	2	\$235.23
Foam Cell - Performance	Suits 6" Lift		24094LFE1	2	\$261.36
Foam Cell Pro - Performance			45094FE	2	\$287.50
Foam Cell Pro - Professional			45094FEP	2	\$287.50
Foam Cell Pro - Performance	Suits 4" Lift		45094LFE	2	\$300.57
Foam Cell Pro - Professional	Suits 4" Lift		45094LFEP	2	\$300.57
Foam Cell Pro - Performance	Suits 6" Lift		45094LFE1	2	\$313.64

Nissan Patrol

Y60 GQ LWB Wagon
1988 to 1998

PRODUCT DESCRIPTION

PART NO.

QTY
RequiredRETAIL
ea Incl GST

COIL SPRINGS

	Est. Lift	Additional Load			
Medium	50mm	0 - 200kg	NISS010B	1	\$235.23
Medium - 4" Lift	100mm	0 - 300kg	NISS027B	1	\$365.91
Medium - 6" Lift	150mm	0 - 300kg	NISS044B	1	\$431.25
Heavy	50mm	200 - 400kg	NISS010C	1	\$248.30
Heavy	50mm	400 - 600kg	NISS020C	1	\$261.36
Heavy - 4" Lift	100mm	400kg - GVM	NISS027C	1	\$365.91
Heavy - 6" Lift	150mm	400kg - GVM	NISS044C	1	\$431.25
Extra Heavy	50mm	600kg - GVM	NISS020D	1	\$392.04

PANHARD ROD

Adjustable Panhard Rod			PANHARD004	1	\$300.57
------------------------	--	--	------------	---	----------

ADJUSTABLE TRAILING ARM

Upper Trailing Arm			UTA003	2	\$196.02
Lower Trailing Arm			LTA003	2	\$248.30

SWAY BAR LINK

Extended Sway Bar Link	Suits 1-3" Lift		SBEXT006	2	\$78.41
Extended Sway Bar Link	Suits 4-7" Lift		SBEXT003	2	\$78.41

COIL SPACER

Polyurethane 15mm	Provides 10mm Lift		PATR15	2	\$26.14
Polyurethane 30mm	Provides 25mm Lift		PATR30	2	\$39.21

BRAKE HOSE

Extended Brake Hose			BHOSE004	1	\$65.34
---------------------	--	--	----------	---	---------

BRACKET KIT

Coil Drop Out Cone			IDOC003	1	\$235.23
Coil Retainer Kit			ICR003	1	\$117.62

BUSH KIT

Rubber Suspension Arm Bush Kit	W/ Standard Radius Arm Bushes		839RK	1	\$378.98
Rubber Suspension Arm Bush Kit	W/ Offset Radius Arm Bushes		839CRK	1	\$378.98

SUSPENSION KIT

Medium - Nitro Gas			NISS009BKG		\$1045.44
Medium - Foam Cell			NISS009BKF		\$1306.80
Medium - Foam Cell	4" Lift	RHD	NISS026BKF		\$3815.86
Medium - Foam Cell	4" Lift	LHD	NISS026BKFL		\$3815.86
Medium - Foam Cell	6" Lift	RHD	NISS043BKF		\$4051.08
Medium - Foam Cell	6" Lift	LHD	NISS043BKFL		\$4051.08
Medium - Foam Cell Pro			NISS009BKP		\$1620.44
Medium - Foam Cell Pro	4" Lift	RHD	NISS026BKP		\$4077.22
Medium - Foam Cell Pro	4" Lift	LHD	NISS026BKPL		\$4077.22
Medium - Foam Cell Pro	6" Lift	RHD	NISS043BKP		\$4260.17
Medium - Foam Cell Pro	6" Lift	LHD	NISS043BKPL		\$4260.17
Heavy - Nitro Gas			NISS009CKG		\$1058.51
Heavy - Foam Cell			NISS009CKF		\$1319.87
Heavy - Foam Cell	4" Lift	RHD	NISS026CKF		\$3815.86
Heavy - Foam Cell	4" Lift	LHD	NISS026CKFL		\$3815.86
Heavy - Foam Cell	6" Lift	RHD	NISS043CKF		\$4051.08
Heavy - Foam Cell	6" Lift	LHD	NISS043CKFL		\$4051.08
Heavy - Foam Cell Pro			NISS009CKP		\$1633.50
Heavy - Foam Cell Pro	4" Lift	RHD	NISS026CKP		\$4077.22
Heavy - Foam Cell Pro	4" Lift	LHD	NISS026CKPL		\$4077.22
Heavy - Foam Cell Pro	6" Lift	RHD	NISS043CKP		\$4260.17
Heavy - Foam Cell Pro	6" Lift	LHD	NISS043CKPL		\$4260.17
Extra Heavy - Nitro Gas			NISS020CKG		\$1071.58
Extra Heavy - Foam Cell			NISS020CKF		\$1332.94
Extra Heavy - Foam Cell Pro			NISS020CKP		\$1646.57
Super Heavy - Nitro Gas			NISS024DKG		\$1202.26
Super Heavy - Foam Cell			NISS024DKF		\$1463.62
Super Heavy - Foam Cell Pro			NISS024DKP		\$1777.25

• 4" and 6" lifts may not be legal for on-road use in your area, certification may be required for on-road use

• Due to the extreme nature of 4" and 6" lifts, further modifications may be required, and will vary between vehicles

Such modifications are entirely the owners responsibility. Ironman 4x4 accept no responsibility for any damage or injury caused by use of the these products

50MM SUSPENSION KIT CONTENTS

Shock Absorbers Coil Springs

4" AND 6" SUSPENSION KIT CONTENTS

Shock Absorbers Caster Plates
Coil Springs Brake Hoses
Panhard Rods Adjustable Trailing Arms
Sway Bar Links

Nissan Patrol

Y60 GQ SWB Wagon
1988 to 1998



PRODUCT DESCRIPTION

PART NO.

QTY
Required

RETAIL
ea Incl GST

SUSPENSION TO SUIT NISSAN PATROL

FRONT SUSPENSION

SHOCK ABSORBER

Nitro Gas - Performance			12091GR	2	\$143.75
Foam Cell - Performance			24091FE	2	\$209.09
Foam Cell - Professional			24091FEP	2	\$209.09
Foam Cell - Performance	Suits 5" Lift		24091LFE	2	\$235.23
Foam Cell - Performance	Suits 7" Lift		24091LFE1	2	\$261.36
Foam Cell Pro - Performance			45091FE	2	\$287.50
Foam Cell Pro - Professional			45091FEP	2	\$287.50
Foam Cell Pro - Performance	Suits 5" Lift		45091LFE	2	\$300.57
Foam Cell Pro - Professional	Suits 5" Lift		45091LFEP	2	\$300.57
Foam Cell Pro - Performance	Suits 7" Lift		45091LFE1	2	\$313.64

COIL SPRINGS

	Est. Lift	Additional Load			
Medium	50mm	0 - 50kg	NISS007B	1	\$235.23
Medium - 5" Lift	125mm	0 - 100kg	NISS026B	1	\$365.91
Medium - 7" Lift	175mm	0 - 100kg	NISS043B	1	\$431.25
Heavy	50mm	50 - 110kg	NISS009B	1	\$235.23

STEERING DAMPER

Foam Cell	Pre 8/1989	3534	1	\$156.82
Foam Cell	8/1989+	3536	1	\$156.82

CASTER CORRECTION

2° Offset Bush Kit - Polyurethane		1144SK	1	\$143.75
2° Offset Bush Kit - Rubber		1144RK	1	\$143.75
5° Offset Plate Kit		CPLATE003	1	\$209.09
Radius Arm Spacer	15mm	833WT	1	\$78.41
4° Drop Box		DBOX003	1	\$365.91

CROSSMEMBER SPACER

6mm / 12mm Spacer Kit		1002K	1	\$91.48
-----------------------	--	--------------	---	---------

STEERING RODS

Adjustable Drag Link		ADL003	1	\$457.38
Track Rod		ATR003	1	\$457.38

ADJUSTABLE PANHARD ROD

Right Hand Drive Rod		PANHARD003	1	\$300.57
Left Hand Drive Rod		PANHARD008	1	\$300.57

SWAY BAR LINK

Extended Sway Bar Link	Suits 1-3" Lift	SBEXT006	2	\$78.41
Extended Sway Bar Link	Suits 4-7" Lift	SBEXT003	2	\$78.41

COIL SPACER

Polyurethane 15mm	Provides 10mm Lift	PATF15	2	\$26.14
Polyurethane 30mm	Provides 25mm Lift	PATF30	2	\$39.21

BRAKE HOSE

Extended Brake Hose		BHOSE003	1	\$65.34
---------------------	--	-----------------	---	---------

REAR SUSPENSION

SHOCK ABSORBER

Nitro Gas - Performance			12094GR	2	\$143.75
Foam Cell - Performance			24094FE	2	\$209.09
Foam Cell - Professional			24094FEP	2	\$209.09
Foam Cell - Performance	Suits 5" Lift		24094LFE	2	\$235.23
Foam Cell - Professional	Suits 5" Lift		24094LFEP	2	\$235.23
Foam Cell - Performance	Suits 7" Lift		24094LFE1	2	\$261.36
Foam Cell Pro - Performance			45094FE	2	\$287.50
Foam Cell Pro - Professional			45094FEP	2	\$287.50
Foam Cell Pro - Performance	Suits 5" Lift		45094LFE	2	\$300.57
Foam Cell Pro - Professional	Suits 5" Lift		45094LFEP	2	\$300.57
Foam Cell Pro - Performance	Suits 7" Lift		45094LFE1	2	\$313.64

Nissan Patrol

Y60 GQ SWB Wagon
1988 to 1998



PRODUCT DESCRIPTION	PART NO.	QTY Required	RETAIL ea Incl GST
COIL SPRINGS			
Medium		Est. Lift	Additional Load
Medium - 5" Lift	NISS008B	50mm	0 - 200kg
Medium - 7" Lift	NISS027B	125mm	0 - 300kg
Heavy	NISS044B	175mm	0 - 300kg
Extra Heavy	NISS010B	50mm	200 - 400kg
	NISS010C	55mm	400kg - GVM
PANHARD ROD			
Adjustable Panhard Rod	PANHARD004	1	\$300.57
ADJUSTABLE TRAILING ARM			
Upper Trailing Arm	UTA003	2	\$196.02
Lower Trailing Arm	LTA003	2	\$248.30
SWAY BAR LINK			
Extended Sway Bar Link	SBEXT006	Suits 1-3" Lift	\$78.41
Extended Sway Bar Link	SBEXT003	Suits 4-7" Lift	\$78.41
COIL SPACER			
Polyurethane 15mm	PATR15	Provides 10mm Lift	\$26.14
Polyurethane 30mm	PATR30	Provides 25mm Lift	\$39.21
BRAKE HOSE			
Extended Brake Hose	BHOSE004	1	\$65.34
BRACKET KIT			
Coil Drop Out Cone	IDOC003	1	\$235.23
Coil Retainer Kit	ICR003	1	\$117.62
BUSH KIT			
Rubber Suspension Arm Bush Kit	839RK	W/ Standard Radius Arm Bushes	\$378.98
Rubber Suspension Arm Bush Kit	839CRK	W/ Offset Radius Arm Bushes	\$378.98

SUSPENSION KIT

Medium - Nitro Gas	NISS007BKG		\$1045.44
Medium - Foam Cell	NISS007BKF		\$1306.80
Medium - Foam Cell	NISS026BKF	5" Lift RHD	\$3815.86
Medium - Foam Cell	NISS026BKFL	5" Lift LHD	\$3815.86
Medium - Foam Cell	NISS043BKF	7" Lift RHD	\$4051.08
Medium - Foam Cell	NISS043BKFL	7" Lift LHD	\$4051.08
Medium - Foam Cell Pro	NISS007BKP		\$1620.44
Medium - Foam Cell Pro	NISS026BKP	5" Lift RHD	\$4077.22
Medium - Foam Cell Pro	NISS026BKPL	5" Lift LHD	\$4077.22
Medium - Foam Cell Pro	NISS043BKP	7" Lift RHD	\$4260.17
Medium - Foam Cell Pro	NISS043BKPL	7" Lift LHD	\$4260.17
Heavy - Nitro Gas	NISS009BKG		\$1045.44
Heavy - Foam Cell	NISS009BKF		\$1306.80
Heavy - Foam Cell Pro	NISS009BKP		\$1620.44
Extra Heavy - Nitro Gas	NISS009BKG1		\$1058.51
Extra Heavy - Foam Cell	NISS009BKF1		\$1319.87
Extra Heavy - Foam Cell Pro	NISS009BKP1		\$1633.50

• 5" and 7" lifts may not be legal for on-road use in your area, certification may be required for on-road use

• Due to the extreme nature of 5" and 7" lifts, further modifications may be required, and will vary between vehicles

Such modifications are entirely the owners responsibility. Ironman 4x4 accept no responsibility for any damage or injury caused by use of the these products

50MM SUSPENSION KIT CONTENTS

Shock Absorbers Coil Springs

4" AND 6" SUSPENSION KIT CONTENTS

Shock Absorbers Caster Plates
Coil Springs Brake Hoses
Panhard Rods Adjustable Trailing Arms
Sway Bar Links



Nissan Patrol

MK G160 (Rectangle Headlights)
1984+



PRODUCT DESCRIPTION

PART NO.

QTY
Required

RETAIL
ea Incl GST

SUSPENSION TO SUIT NISSAN PATROL

FRONT SUSPENSION

SHOCK ABSORBER

Nitro Gas - Performance 12075GR 2 \$143.75

LEAF SPRINGS

	Est. Lift	Additional Load			
Medium - Drivers Side (Petrol)	45mm	0 - 50kg	NISS005BD/S	1	\$352.84
Medium - Near Side (Petrol)	45mm	0 - 50kg	NISS005BN/S	1	\$352.84

STEERING DAMPER

Foam Cell 3522 1 \$156.82

U-BOLTS

U-Bolt Kit	Drivers side	452UBK	1	\$39.21
U-Bolt Kit	Near side	451UBK	1	\$39.21

POLYURETHANE SPRING BUSHES

Bush Kit 724UK 1 \$78.41

GREASABLE SHACKLES AND PINS

Greasable Shackle	Stepped Side Plates	665	2	\$65.34
Greasable Pin		470	2	\$39.21

REAR SUSPENSION

SHOCK ABSORBER

Nitro Gas - Performance 12076GR 2 \$143.75

LEAF SPRINGS

	Est. Lift	Additional Load			
Medium - Drivers Side	45mm	0 - 200kg	NISS004BD/S	1	\$378.98
Medium - Near Side	45mm	0 - 200kg	NISS004BN/S	1	\$378.98

U-BOLTS

U-Bolt Kit 453UBK 2 \$39.21

POLYURETHANE SPRING BUSHES

Bush Kit 722UK 1 \$78.41

GREASABLE SHACKLES AND PINS

Greasable Shackle		664	2	\$65.34
Greasable Pin		470	2	\$39.21

HELPER SPRINGS

Load Plus Helper Springs	LP3	1	\$156.82
Add-A-Leaf	ISL6010	1	\$156.82

SUSPENSION KIT

Medium - Nitro Gas NISS005BKG \$2352.24

SUSPENSION KIT CONTENTS

Shock Absorbers	U-Bolts
Leaf Springs	Polyurethane Spring Bushes

Nissan Patrol

MQ G160 (Round Headlights)
Pre 1984

PRODUCT DESCRIPTION

PART NO.

QTY
RequiredRETAIL
ea Incl GST

SUSPENSION TO SUIT NISSAN PATROL

FRONT SUSPENSION

SHOCK ABSORBER

Nitro Gas - Performance			12075GR	2	\$143.75
-------------------------	--	--	----------------	---	----------

LEAF SPRINGS

	Est. Lift	Additional Load			
Medium - Drivers Side (Petrol)	45mm	0 - 50kg	NISS003BD/S	1	\$352.84
Medium - Near Side (Petrol)	45mm	0 - 50kg	NISS003BN/S	1	\$352.84

STEERING DAMPER

Foam Cell			3522	1	\$156.82
-----------	--	--	-------------	---	----------

U-BOLTS

U-Bolt Kit	Drivers side		452UBK	1	\$39.21
U-Bolt Kit	Near side		451UBK	1	\$39.21

STEEL SPRING BUSHES

Bush Kit			721UK	1	\$78.41
----------	--	--	--------------	---	---------

GREASABLE SHACKLES AND PINS

Greasable Shackle	Straight Side Plates		355K	2	\$65.34
Greasable Pin			470	2	\$39.21

REAR SUSPENSION

SHOCK ABSORBER

Nitro Gas - Performance			12076GR	2	\$143.75
-------------------------	--	--	----------------	---	----------

LEAF SPRINGS

	Est. Lift	Additional Load			
Medium - Drivers Side	45mm	0 - 200kg	NISS004BD/S	1	\$378.98
Medium - Near Side	45mm	0 - 200kg	NISS004BN/S	1	\$378.98

U-BOLTS

U-Bolt Kit			453UBK	2	\$39.21
------------	--	--	---------------	---	---------

POLYURETHANE SPRING BUSHES

Bush Kit			722UK	1	\$78.41
----------	--	--	--------------	---	---------

GREASABLE SHACKLES AND PINS

Greasable Shackle			664	2	\$65.34
Greasable Pin			470	2	\$39.21

HELPER SPRINGS

Load Plus Helper Springs			LP3	1	\$156.82
Add-A-Leaf			ISL6010	1	\$156.82

SUSPENSION KIT

Medium - Nitro Gas			NISS003BKG		\$2352.24
--------------------	--	--	-------------------	--	-----------

SUSPENSION KIT CONTENTS

Shock Absorbers	U-Bolts
Leaf Springs	Polyurethane Spring Bushes



PRODUCT DESCRIPTION

PART NO.

QTY
Required

RETAIL
ea Incl GST

SUSPENSION TO SUIT NISSAN XTERRA

FRONT SUSPENSION

SHOCK ABSORBER

Nitro Gas Strut - Performance			12716GR	2	\$209.09
Foam Cell Strut - Performance			24716FE	2	\$235.23
Foam Cell Pro Strut - Performance			45716FE	2	\$365.91
Foam Cell Pro Strut - Performance - Long Travel* (SEE NOTE)			45716LFE *	2	\$365.91

*NOTE: MANDATORY FITMENT of Ironman 4x4 UCA048FA is required with Long Travel - Foam Cell Pro

• Height adjustable with Ironman 4x4 Strut Trim Packers

• Foam Cell Pro contains a single adjusting ring for driveshaft clearance

COIL SPRINGS

	Est. Lift	Additional Load			
Medium	35mm	0 - 50kg	NISS040B	1	\$235.23
Heavy	35mm	50 - 110kg	NISS040C	1	\$235.41

STRUT MOUNTS

Steel Strut Top			ISST007	2	\$78.41
-----------------	--	--	----------------	---	---------

TRIM PACKERS

5mm Strut Trim Packer	Nitro Gas / Foam Cell	HILFR05 / HILFR05F	2	\$26.14
10mm Strut Trim Packer	Nitro Gas / Foam Cell	HILFR10 / HILFR10F	2	\$26.14
15mm Strut Trim Packer	Nitro Gas / Foam Cell	HILFR15 / HILFR15F	2	\$26.14

• ONLY Compatible with Ironman 4x4 Struts (Except Pro), lift height subject to 2:1 motion ratio. Unnecessary fitment may lift vehicle too high

CONTROL ARMS

Pro-Forge Upper Control Arms			UCA048FA	1	\$831.60
------------------------------	--	--	-----------------	---	----------

REAR SUSPENSION

SHOCK ABSORBER

Nitro Gas - Performance			12717GR	2	\$143.75
Foam Cell - Performance			24717FE	2	\$209.09
Foam Cell - Professional			24717FEP	2	\$209.09
Foam Cell Pro - Performance			45717FE	2	\$287.50
Foam Cell Pro - Professional			45717FEP	2	\$287.50

LEAF SPRINGS

	Est. Lift	Additional Load			
Medium	45mm	0 - 300kg	NISS047B	2	\$352.84

U-BOLTS

U-Bolt Kit			416UBK	2	\$39.21
------------	--	--	---------------	---	---------

POLYURETHANE SPRING BUSHES

Bush Kit			769UK	1	\$78.41
----------	--	--	--------------	---	---------

GREASABLE SHACKLES AND PINS

Greasable Shackle			797-1	2	\$52.28
-------------------	--	--	--------------	---	---------

HELPER SPRINGS

Load Plus Helper Springs			LP2	1	\$156.82
Add-A-Leaf			ISL6010	1	\$156.82

SUSPENSION KIT

Medium - Nitro Gas		NISS047BKG	\$1803.39
Medium - Foam Cell		NISS047BKF	\$1986.34
Medium - Foam Cell Pro		NISS047BKP	\$2404.52

• Specify front Coil Springs when ordering

SUSPENSION KIT CONTENTS

Shock Absorbers	Coil Springs	Polyurethane Spring Bushes
Leaf Springs	U-Bolts	



T30
2001 to 9/2007

SUSPENSION TO SUIT

Nissan X-Trail

PRODUCT DESCRIPTION

PART NO.

QTY
Required

RETAIL
ea Incl GST

SUSPENSION TO SUIT NISSAN X-TRAIL

FRONT SUSPENSION

COIL SPRINGS	Est. Lift	Additional Load			
Medium	35mm	0 - 50kg	NISS038B	1	\$235.23
CAMBER CORRECTION					
Camber Bolt Kit			ICAMBER12	1	\$26.14

REAR SUSPENSION

COIL SPRINGS	Est. Lift	Additional Load			
Medium	35mm	0 - 200kg	NISS039B	1	\$235.23



Ready for work and play

for a full range of accessories visit our website

www.ironman4x4.com



DS
2014 to 2019

PRODUCT DESCRIPTION

PART NO.

QTY
RequiredRETAIL
ea Incl GST

SUSPENSION TO SUIT RAM 1500

FRONT SUSPENSION

SHOCK ABSORBER

Foam Cell Pro Strut - Performance			45855FE	2	\$365.91
Foam Cell Pro Strut - Long Travel* (SEE NOTE)			45855LFE *	2	\$365.91

*NOTE: MANDATORY FITMENT of UCA075FA and SBEXT075 is required with Long Travel - Foam Cell Pro Strut

COIL SPRINGS

	Est. Lift	Additional Load			
Light	2" Lift	0 - 50kg	RAM015A	1	\$235.23
Medium	2" Lift	0 - 60kg	RAM015B	1	\$235.23
Heavy	2" Lift	60 - 110kg	RAM015C	1	\$235.23

STRUT MOUNTS

Steel Strut Top			ISST075	2	\$91.48
-----------------	--	--	---------	---	---------

SWAY BAR LINK

Adjustable Sway Bar Link			SBEXT075	2	\$133.10
--------------------------	--	--	----------	---	----------

CONTROL ARMS

Pro-Forge Upper Control Arms			UCA075FA	1	\$831.60
------------------------------	--	--	----------	---	----------

REAR SUSPENSION

SHOCK ABSORBER

Foam Cell Pro - Comfort			45856FEC	2	\$287.50
Foam Cell Pro - Comfort - Long Travel* (SEE NOTE)			45856LFEC *	2	\$287.50
Foam Cell Pro - Performance			45856FE	2	\$287.50
Foam Cell Pro - Performance - Long Travel* (SEE NOTE)			45856LFE *	2	\$287.50

*NOTE: MANDATORY FITMENT of Ironman 4x4 Coil Springs are required with Long Travel - Foam Cell Pro

COIL SPRINGS

	Est. Lift	Additional Load			
Light	1.5" Lift	0 - 200kg	RAM016A	1	\$235.23
Medium	2" Lift	0 - 300kg	RAM016B	1	\$235.23
Heavy	2" Lift	200 - 500kg	RAM016C	1	\$235.23

SUSPENSION KIT

Light - Foam Cell Pro	1.5" Lift	RAM016AKP	\$2226.40
Medium - Foam Cell Pro	2" Lift	RAM016BKP	\$2226.40
Medium - Foam Cell Pro*	2.5" Lift	RAM016BKP1	\$3141.16
Heavy - Foam Cell Pro	2" Lift	RAM016CKP	\$2226.40
Heavy - Foam Cell Pro*	2.5" Lift	RAM016CKP1	\$3141.16

* Adjust 45855LFE seat height to 193mm

SUSPENSION KIT CONTENTS

Shock Absorbers	Coil Springs	Sway Bar Links
Strut Shock Absorbers	Strut Mounts	Upper Control Arms (2.5" lift kit only)



PRODUCT DESCRIPTION

PART NO.

QTY
RequiredRETAIL
ea Incl GST

ACCESSORIES TO SUIT RENAULT ALASKAN

STEEL WINCH BULL BARS - THAI BUILT MODEL ONLY

Commercial	BBC048	\$1569.00
Commercial Deluxe	BBCD048	\$1985.00
Polished Alloy	BBA048	\$2472.00
Proguard No Loop	BBT048-NL	\$1641.00
Proguard Single Loop Kit	BB048-SL	\$297.00
Proguard Triple Loop Kit	BB048-TL	\$357.00

STEEL SIDE STEPS AND RAILS - FITS DUAL CAB MODELS ONLY

Side Steps	SS048	\$851.00
Side Rails	SS048 RAIL	\$280.00
Side Steps and Rails	SSR048	\$1022.00

TOWING

Class 4 Towbar - Compatible with Factory Rear Bumper	TB048	\$523.00
Rear Protection Towbar - Full Rear Bumper Replacement	RTB048	\$1196.00
Rear Protection Towbar Plates (Pair)	RTBPLATE048	\$131.00
Towbar Wiring Loom - Plug and Play	ITBL048	\$248.00

LOCKSAFE DRAWER SYSTEMS

Twin Drawers - 1300mm	ITD1300	\$1469.00
Single Drawer - 1300mm	ISD1300	\$891.00
Wing Kit - 1300mm*	ITDW048	\$351.00

*Designed to suit factory tubs, will not suit ute liner without modification.

LONG RANGE FUEL TANK

140L* - Auto/Coil Spring Diesel only	TANK048	\$1129.00
--------------------------------------	---------	-----------

*Usable volume may differ to the stated tank capacity

PREMIUM UNDERBODY PROTECTION

Engine Bay and Transmission - Series 1	UBP048	\$712.00
Engine Bay and Transmission - Series 2, 3 and 4	UBP048S	\$712.00

EXHAUST SYSTEM

3" Exhaust Upgrade 2.3L - DPF Back - While Stocks Last	IEX048	\$770.00
--	--------	----------

CANOPY - ABS PLASTIC (SIDE LIFT UP WINDOWS AND CENTRAL LOCKING REAR DOOR) - FITS 4X4 AND 4X2 DUAL CAB MODELS

White (QM1)	CANOPY013-PW	\$3743.00
Brilliant Silver (K23)	CANOPY013-BS	\$3743.00
White Diamond (QX1)	CANOPY013-WP	\$3743.00
Cosmic Black (G42)	CANOPY013-CB	\$3743.00
Slate Grey (K21)	CANOPY013-SG	\$3743.00

CANOPY - SMOOTH FINISH FIBREGLASS PINNACLE (SIDE LIFT UP WINDOWS AND CENTRAL LOCKING REAR DOOR) - FITS 4X4 AND 4X2 DUAL CAB MODELS

Pre-Primed	CANFIBRE048-P	\$2783.00*
White (QM1)	CANFIBRE048-PW	\$3297.00
Brilliant Silver (K23)	CANFIBRE048-BS	\$3297.00
Hornet Gold (EAU)	CANFIBRE048-HG	\$3297.00
White Diamond (QX1)	CANFIBRE048-WP	\$3297.00
Cosmic Black (G42)	CANFIBRE048-CB	\$3297.00
Slate Grey (K21)	CANFIBRE048-SG	\$3297.00

*Pre-primed canopies, plus colour coding.

DIFF BREATHER KIT

Diff Breather Kit	IDIFFBRE	\$114.00
-------------------	----------	----------



2017+

Renault Alaskan

PRODUCT DESCRIPTION

PART NO.

QTY
RequiredRETAIL
ea Incl GST

SUSPENSION TO SUIT RENAULT ALASKAN

FRONT SUSPENSION

SHOCK ABSORBER

Nitro Gas Strut - Performance			12716GR	2	\$209.09
Foam Cell Strut - Performance			24716FE	2	\$235.23
Foam Cell Pro Strut - Performance			45716FE	2	\$365.91
Foam Cell Pro Strut - Performance - Long Travel* (SEE NOTE)			45716LFE *	2	\$365.91

*NOTE: MANDATORY FITMENT of Ironman 4x4 UCA048FA is required with Long Travel - Foam Cell Pro

- Height adjustable with Ironman 4x4 Strut Trim Packers
- Foam Cell Pro contains a single adjusting ring for driveshaft clearance

COIL SPRINGS

	Est. Lift	Additional Load			
Standard Height	0mm	0 - 50kg	NISS040A	1	\$235.23
Light	20mm	0 - 50kg	NISS040B	1	\$235.23
Medium	35mm	0 - 80kg	NISS040C	1	\$235.41
Heavy	40mm	50 - 110kg	NISS040D	1	\$235.23

• Series 3+ vehicles are produced with a 25mm increased ride height from factory. The resulting lift estimates with Ironman 4x4 suspension will be 25mm less than stated above

STRUT MOUNTS

Steel Strut Top			ISST007	2	\$78.41
-----------------	--	--	----------------	---	---------

TRIM PACKERS

5mm Strut Trim Packer	Nitro Gas / Foam Cell	HILFR05 / HILFR05F	2	\$26.14
10mm Strut Trim Packer	Nitro Gas / Foam Cell	HILFR10 / HILFR10F	2	\$26.14
15mm Strut Trim Packer	Nitro Gas / Foam Cell	HILFR15 / HILFR15F	2	\$26.14

• ONLY Compatible with Ironman 4x4 Struts (except Pro), lift height subject to 2:1 motion ratio. Unnecessary fitment may lift vehicle too high

CONTROL ARMS

Pro-Forge Upper Control Arms			UCA048FA	1	\$831.60
------------------------------	--	--	-----------------	---	----------

REAR SUSPENSION

SHOCK ABSORBER

Nitro Gas - Performance			12728GR	2	\$143.75
Foam Cell - Performance			24728FE	2	\$209.09
Foam Cell - Professional			24728FEP	2	\$209.09
Foam Cell Pro - Comfort			45728FEC	2	\$287.50
Foam Cell Pro - Performance			45728FE	2	\$287.50
Foam Cell Pro - Professional			45728FEP	2	\$287.50

COIL SPRINGS

	Est. Lift	Additional Load			
Light	20mm	0 - 200kg	NISS058A	1	\$235.23
Medium	40mm	0 - 300kg	NISS058B	1	\$235.23
Heavy	40mm	300kg - 600kg	NISS058C	1	\$235.23
Extra Heavy	45mm	600kg - GVM	NISS058D	1	\$235.23

• Series 3+ vehicles are produced with a 25mm increased ride height from factory. The resulting lift estimated with Ironman 4x4 suspension will be 25mm less than stated above

COIL SPACER

Polyurethane 20mm			NAVR20	2	\$39.21
-------------------	--	--	---------------	---	---------

SPACER KIT

Sway Bar and Headlight Bracket Extension Kit			1204K	1	\$91.48
--	--	--	--------------	---	---------

SUSPENSION KIT

Medium - Nitro Gas	NISS058BKG	\$1267.60
Medium - Foam Cell	NISS058BKF	\$1450.55
Medium - Foam Cell Pro	NISS058BKP	\$1868.73
Heavy - Nitro Gas	NISS058CKG	\$1267.60
Heavy - Foam Cell	NISS058CKF	\$1450.55
Heavy - Foam Cell Pro	NISS058CKP	\$1868.73
Extra Heavy - Nitro Gas	NISS058DKG	\$1267.60
Extra Heavy - Foam Cell	NISS058DKF	\$1450.55
Extra Heavy - Foam Cell Pro	NISS058DKP	\$1868.73

• Specify front Coil Springs when ordering

• Series 3+ vehicles are produced with a 25mm increased ride height from factory. The resulting lift estimated with Ironman 4x4 suspension will be 25mm less than stated above

SUSPENSION KIT CONTENTS

Shock Absorbers	Strut Shock Absorbers
Coil Springs	Sway Bar and Headlight Bracket Kit



Renault Duster

2010+



PRODUCT DESCRIPTION

PART NO.

QTY
Required

RETAIL
ea Incl GST

SUSPENSION TO SUIT RENAULT DUSTER

FRONT SUSPENSION

SHOCK ABSORBER

Nitro Gas Strut - Performance			12747GR	2	\$261.36
-------------------------------	--	--	----------------	---	----------

COIL SPRINGS

	Est. Lift	Additional Load			
Medium	40mm	0 - 50kg	REN001B	1	\$235.23

CAMBER CORRECTION

Camber Bolt Kit			ICAMBER12	1	\$26.14
-----------------	--	--	------------------	---	---------

REAR SUSPENSION

SHOCK ABSORBER

Nitro Gas Strut - Performance			12748GR	2	\$261.36
-------------------------------	--	--	----------------	---	----------

COIL SPRINGS

	Est. Lift	Additional Load			
Medium	40mm	0 - 200kg	REN002B	1	\$235.23

CAMBER CORRECTION

Camber Bolt Kit			ICAMBER12	1	\$26.14
-----------------	--	--	------------------	---	---------

SUSPENSION KIT

Medium - Nitro Gas			REN001BKG		\$1568.16
--------------------	--	--	------------------	--	-----------

SUSPENSION KIT CONTENTS

Shock Absorbers Camber Correction
Coil Springs



Q200 / Q201 / Q205
10/2018+

SsangYong Musso

PRODUCT DESCRIPTION

PART NO.

QTY
Required

RETAIL
ea Incl GST

ACCESSORIES TO SUIT SSANGYONG MUSSO

STEEL WINCH BULL BARS

Commercial Deluxe

BBCD071

\$1985.00

• Winch with Steel Cable and Roller Fairlead is not suitable - Use Winch with Synthetic Rope and Alloy Hawse only

PREMIUM UNDERBODY PROTECTION

Engine Bay and Transmission

UBP201SY

\$500.00

DIFF BREATHER KIT

Diff Breather Kit

IDIFFBRE

\$114.00

LISTING
CONTINUED
OVER THE
PAGE





SUSPENSION TO SUIT SSANGYONG MUSSO

FRONT SUSPENSION

SHOCK ABSORBER

Nitro Gas Strut - Performance			12823GR	2	\$209.09
-------------------------------	--	--	----------------	---	----------

COIL SPRINGS

	Est. Lift	Additional Load			
Medium	30mm	0-50kg	SSANG003B	1	\$235.23
Heavy	35mm	50-100kg	SSANG003C	1	\$235.23

• Estimated lift is 15mm less in 2020+ models due to factory OEM height increase

REAR SUSPENSION

SHOCK ABSORBER

Nitro Gas - Performance			12824GR	2	\$143.75
-------------------------	--	--	----------------	---	----------

COIL SPRINGS

	Est. Lift	Additional Load			
Medium	35mm	0 - 200kg	SSANG004B	1	\$235.23
Heavy	40mm	200 - 400kg	SSANG004C	1	\$235.23

• Estimated lift is 15mm less in 2020+ models due to factory OEM height increase

SUSPENSION KIT

Medium - Nitro Gas		SSANG004BKG	\$1881.80
Heavy - Nitro Gas		SSANG004CKG	\$1934.07

• Specify front Coil Springs when ordering

• Estimated lift is 15mm less in 2020+ models due to factory OEM height increase

SUSPENSION KIT CONTENTS

Shock Absorbers	Coil Springs
Strut Shock Absorbers	



Q201 LWB (Coil)
10/2018+

SsangYong Musso

PRODUCT DESCRIPTION

PART NO.

QTY Required

RETAIL ea Incl GST

SUSPENSION TO SUIT SSANGYONG MUSSO

FRONT SUSPENSION

SHOCK ABSORBER

Nitro Gas Strut - Performance			12823GR	2	\$209.09
-------------------------------	--	--	----------------	---	----------

COIL SPRINGS

	Est. Lift	Additional Load			
Medium	30mm	0 - 50kg	SSANG003B	1	\$235.23
Heavy	35mm	50 - 100kg	SSANG003C	1	\$235.23

• Estimated lift is 15mm less in 2020+ models due to factory OEM height increase

REAR SUSPENSION

SHOCK ABSORBER

Nitro Gas - Performance			12825GR	2	\$143.75
-------------------------	--	--	----------------	---	----------

COIL SPRINGS

	Est. Lift	Additional Load			
Medium	35mm	0 - 200kg	SSANG006B	1	\$235.23
Heavy	40mm	200 - 400kg	SSANG006C	1	\$235.23

• Estimated lift is 15mm less in 2020+ models due to factory OEM height increase

SUSPENSION KIT

Medium - Nitro Gas		SSANG006BKG	\$1176.12
Heavy - Nitro Gas		SSANG006CKG	\$1176.12

• Specify front Coil Springs when ordering

• Estimated lift is 15mm less in 2020+ models due to factory OEM height increase

SUSPENSION KIT CONTENTS

Shock Absorbers	Coil Springs
Strut Shock Absorbers	



PRODUCT DESCRIPTION

PART NO.

QTY
Required

RETAIL
ea Incl GST

SUSPENSION TO SUIT SSANGYONG MUSSO

FRONT SUSPENSION

SHOCK ABSORBER

Nitro Gas Strut - Performance			12823GR	2	\$209.09
-------------------------------	--	--	----------------	---	----------

COIL SPRINGS

	Est. Lift	Additional Load			
Medium	30mm	0-50kg	SSANG003B	1	\$235.23
Heavy	35mm	50-100kg	SSANG003C	1	\$235.23

• Estimated lift is 15mm less in 2020+ models due to factory OEM height increase

REAR SUSPENSION

SHOCK ABSORBER

Nitro Gas - Performance			12826GR	2	\$143.75
-------------------------	--	--	----------------	---	----------

LEAF SPRINGS

	Est. Lift	Additional Load			
Medium	45mm	0-300kg	SSANG005B	2	\$352.84
Heavy	50mm	300kg-GVM	SSANG005C	2	\$378.98

U-BOLTS

U-Bolt Kit			1105UBK	2	\$39.21
------------	--	--	----------------	---	---------

POLYURETHANE SPRING BUSHES

Bush Kit			1153UK	1	\$156.82
----------	--	--	---------------	---	----------

SUSPENSION KIT

Medium - Nitro Gas			SSANG005BKG		\$1881.80
Heavy - Nitro Gas			SSANG005CKG		\$1934.07

SUSPENSION KIT CONTENTS

Shock Absorbers	Coil Springs	U-Bolts
Strut Shock Absorbers	Leaf Springs	Polyurethane Spring Bushes



1996 to 2006

SUSPENSION TO SUIT SsangYong Musso / Korando

PRODUCT DESCRIPTION

PART NO.

QTY
Required

RETAIL
ea Incl GST

SUSPENSION TO SUIT SSANGYONG MUSSO / KORANDO

FRONT SUSPENSION

SHOCK ABSORBER

Nitro Gas - Performance	12667GR	2	\$143.75
Foam Cell - Performance	24667FE	2	\$209.09

TORSION BAR

Uprated Torsion Bars	SSANG001	1	\$548.86
----------------------	-----------------	---	----------

• Minimum 60mm downward suspension travel required after adjustment

REAR SUSPENSION

SHOCK ABSORBER

Nitro Gas - Performance	12661GRS	2	\$143.75
Foam Cell - Performance	24661FES	2	\$209.09

COIL SPRINGS

	Est. Lift	Additional Load		
Medium	45mm	0-200kg	SSANG002B	1

SUSPENSION KIT

Medium - Nitro Gas	SSANG002BKG	\$1359.08
Medium - Foam Cell	SSANG002BKF	\$1620.44

SUSPENSION KIT CONTENTS

Shock Absorbers	Torsion Bars
Coil Springs	

SsangYong Rexton

Y400
10/2018+



PRODUCT DESCRIPTION

PART NO.

QTY
Required

RETAIL
ea Incl GST

ACCESSORIES TO SUIT SSANGYONG REXTON

STEEL WINCH BULL BARS

Commercial Deluxe

BBCD071

\$1985.00

• Winch with Steel Cable and Roller Fairlead is not suitable - Use Winch with Synthetic Rope and Alloy Hawse only

PREMIUM UNDERBODY PROTECTION

Engine Bay and Transmission

UBP201SY

\$500.00

DIFF BREATHER KIT

Diff Breather Kit

IDIFFBRE

\$114.00





Y400 / Y450
2018+

SsangYong Rexton

PRODUCT DESCRIPTION

PART NO.

QTY Required

RETAIL ea Incl GST

SUSPENSION TO SUIT SSANGYONG REXTON

FRONT SUSPENSION

SHOCK ABSORBER

Nitro Gas - Performance			12823GR	2	\$209.09
-------------------------	--	--	----------------	---	----------

COIL SPRINGS

	Est. Lift	Additional Load			
Medium	30mm	0-50kg	SSANG003B	1	\$235.23
Heavy	35mm	50-100kg	SSANG003C	1	\$235.23

REAR SUSPENSION

SHOCK ABSORBER

Nitro Gas - Performance			12828GR	2	\$143.75
-------------------------	--	--	----------------	---	----------

COIL SPRINGS

	Est. Lift	Additional Load			
Medium	40mm	0-200kg	SSANG010B	1	\$235.23

SUSPENSION KIT

Medium - Nitro Gas			SSANG010BKG		\$1176.12
--------------------	--	--	--------------------	--	-----------

SUSPENSION KIT CONTENTS

Shock Absorbers	Coil Springs
Strut Shock Absorbers	



PRODUCT DESCRIPTION

PART NO.

QTY
RequiredRETAIL
ea Incl GST

SUSPENSION TO SUIT SUBARU FORESTER

FRONT SUSPENSION

SHOCK ABSORBER	Est. Lift	Additional Load			
Nitro Gas Strut Assembly Left - Performance	50mm	0 - 50kg	12830007GR LH	1	\$444.32
Nitro Gas Strut Assembly Right- Performance	50mm	0 - 50kg	12830007GR RH	1	\$444.32

• Strut Assembly includes pre-assembled Coil Springs, Shock Absorber and Strut Top Cap

REAR SUSPENSION

SHOCK ABSORBER	Est. Lift	Additional Load			
Nitro Gas Strut Assembly - Performance	50mm	0 - 200kg	12832008GR	2	\$432.22

• Strut Assembly includes pre-assembled Coil Springs, Shock Absorber and Strut Top Cap

SPACER KIT

Sway Bar Relocation Kit			1216K	1	\$108.90
Sub Frame Alignment Kit			1215K	1	\$278.30

SUSPENSION KIT

Medium - Nitro Gas			SUB007BKG		\$2140.25
--------------------	--	--	------------------	--	-----------

SUSPENSION KIT CONTENTS

Left / Right Front Strut Assemblies	Rear Subframe Alignment Kit
Rear Strut Assemblies	Sway Bar Relocation Kit



SF5, GX, RX, GT
1997 to 2013

Subaru Forester

PRODUCT DESCRIPTION

PART NO.

QTY
Required

RETAIL
ea Incl GST

SUSPENSION TO SUIT SUBARU FORESTER

FRONT SUSPENSION

COIL SPRINGS	Est. Lift	Additional Load			
Medium - 1997 - 2001	35mm	0 - 50kg	SUB001B	1	\$235.23
Medium - 2002 - 2008	35mm	0 - 50kg	SUB003B	1	\$235.23
Medium - 2008 - 2013	20mm	0 - 50kg	SUB005B	1	\$235.23
CAMBER CORRECTION					
Camber Bolt Kit			ICAMBER14	1	\$26.14

REAR SUSPENSION

COIL SPRINGS	Est. Lift	Additional Load			
Medium - 1997 - 2001	35mm	0 - 200kg	SUB002B	1	\$235.23
Medium - 2002 - 2008	35mm	0 - 200kg	SUB004B	1	\$235.23
Medium - 2008 - 2013	20mm	0 - 200kg	SUB006B	1	\$235.23
• Not suitable for self leveling suspension models					
CAMBER CORRECTION					
Camber Bolt Kit			ICAMBER14	1	\$26.14



Subaru Outback

2015 to 2019
2020+



PRODUCT DESCRIPTION

PART NO.

QTY
Required

RETAIL
ea Incl GST

SUSPENSION TO SUIT SUBARU OUTBACK

FRONT SUSPENSION

SHOCK ABSORBER	Est. Lift	Additional Load			
Nitro Gas Strut Assembly Left - Performance (2015-2019)	50mm	0 - 50kg	12833009GR LH	1	\$444.32
Nitro Gas Strut Assembly Right- Performance (2015-2019)	50mm	0 - 50kg	12833009GR RH	1	\$444.32
Nitro Gas Strut Assembly Left - Performance (2020+)	50mm	0 - 50kg	12831009GR LH	1	\$444.32
Nitro Gas Strut Assembly Right- Performance (2020+)	50mm	0 - 50kg	12831009GR RH	1	\$444.32

• Strut Assembly includes pre-assembled Coil Springs, Shock Absorber and Strut Top Cap

REAR SUSPENSION

SHOCK ABSORBER	Est. Lift	Additional Load			
Nitro Gas Strut Assembly - Performance (2015-2019)	50mm	0 - 200kg	12834010GR	2	\$432.22
Nitro Gas Strut Assembly - Performance (2020+)	50mm	0 - 200kg	12834014GR	2	\$432.22

• Strut Assembly includes pre-assembled Coil Springs, Shock Absorber and Strut Top Cap

SPACER KIT

Sub Frame Alignment Kit			1215K	1	\$278.30
-------------------------	--	--	--------------	---	----------

SUSPENSION KIT

Medium - Nitro Gas (2015-2019)			SUB009BKG		\$2031.35
Medium - Nitro Gas (2020+)			SUB009BKG1		\$2031.35

SUSPENSION KIT CONTENTS

Left / Right Front Strut Assemblies Rear Subframe Alignment Kit
Rear Strut Assemblies



2018+

Subaru XV Crosstrek

PRODUCT DESCRIPTION

PART NO.

QTY
RequiredRETAIL
ea Incl GST

SUSPENSION TO SUIT SUBARU XV CROSSTREK

FRONT SUSPENSION

SHOCK ABSORBER	Est. Lift	Additional Load			
Nitro Gas Strut Assembly Left - Performance	50mm	0 - 50kg	12835011GR LH	1	\$444.32
Nitro Gas Strut Assembly Right- Performance	50mm	0 - 50kg	12835011GR RH	1	\$444.32

• Strut Assembly includes pre-assembled Coil Springs, Shock Absorber and Strut Top Cap

REAR SUSPENSION

SHOCK ABSORBER	Est. Lift	Additional Load			
Nitro Gas Strut Assembly - Performance	50mm	0 - 200kg	12836012GR	2	\$432.22

• Strut Assembly includes pre-assembled Coil Springs, Shock Absorber and Strut Top Cap

SPACER KIT

Sway Bar Relocation Kit			1216K	1	\$108.90
Sub Frame Alignment Kit			1215K	1	\$278.30

EXHAUST HANGER KIT

Exhaust Hanger Rubber			1EXH4075	3	\$13.75
-----------------------	--	--	-----------------	---	---------

SUSPENSION KIT

Medium - Nitro Gas			SUB011BKG		\$2181.50
--------------------	--	--	------------------	--	-----------

SUSPENSION KIT CONTENTS

Left / Right Front Strut Assemblies	Rear Subframe Alignment Kit	Exhaust Hanger Rubbers
Rear Strut Assemblies	Sway Bar Relocation Kit	



PRODUCT DESCRIPTION

PART NO.

QTY
Required

RETAIL
ea Incl GST

ACCESSORIES TO SUIT SUZUKI JIMNY

STEEL WINCH BULL BARS

Commercial Deluxe*	BBCD070	\$1615.00
Jimny Special*	BBS070	\$1615.00
Driving Light Patch Loom	IPL070	\$30.00

• Winch with Steel Cable and Roller Fairlead is not suitable - Use Winch with Synthetic Rope and Alloy Hawse only

• Uses factory fog/DRL Lights. Suits factory flares

* Black textured paint

RECOVERY POINTS - IRONMAN 4X4 BULL BAR ONLY

Recovery Points - 5000kg Rating (Pair)	IRP070	\$265.00
--	--------	----------

ALLOY ROOF RACKS

Cage Style - 1.4m x 1.25m	IRRCAGE14-ALLOY	\$897.00
Trade Style - 1.4m x 1.25m (Open end)	IRROPEN14-ALLOY	\$886.00

ROOF RACK - MOUNTING KITS

Gutter Mount Feet - 100mm (8 Feet)	IRRFEET100	\$180.00
------------------------------------	------------	----------

PREMIUM UNDERBODY PROTECTION

Transfer Case, Driveline and Exhaust	UBP070	\$500.00
--------------------------------------	--------	----------

SNORKEL

2018+	ISNORKE070	\$387.00
-------	------------	----------

SEAT COVER

Canvas Comfort - Front	ICSC070F	\$400.00
Canvas Comfort - Rear	ICSC070R	\$400.00

DIFF BREATHER KIT

Diff Breather Kit	IDIFFBRE	\$114.00
-------------------	----------	----------



GJ
2018+

PRODUCT DESCRIPTION

PART NO.

QTY
RequiredRETAIL
ea Incl GST

SUSPENSION TO SUIT SUZUKI JIMNY

FRONT SUSPENSION

SHOCK ABSORBER

Nitro Gas - Performance 12759GR 2 \$143.75

STEERING DAMPER

Foam Cell 3542 1 \$156.82

COIL SPRINGS

	Est. Lift	Additional Load			
Medium	50mm	0 - 50kg	SUZ009B	1	\$235.23
Heavy	50mm	50 - 80kg	SUZ009C	1	\$235.23

PANHARD ROD

Adjustable Panhard Rod LHD PANHARD017L 1 \$300.57

Adjustable Panhard Rod RHD PANHARD017 1 \$300.57

CHASSIS DROPMEMBER

Front Crossmember Drop Brackets IDM009 1 \$130.68

OFFSET CASTER BUSH KIT

Offset Bush Kit Rubber 2 Degree offset 1146RK 1 \$117.62

BUMP STOP

Extended Bump Stop 1219R 1 \$36.30

• Must install IDM009 Droptmember when fitting 1146RK and 12759GR

REAR SUSPENSION

SHOCK ABSORBER

Nitro Gas - Performance 12760GR 2 \$143.75

COIL SPRINGS

	Est. Lift	Additional Load			
Medium - RHD	50mm	0 - 200kg	SUZ010B	1	\$235.23
Medium - LHD	50mm	0 - 200kg	SUZ011B	1	\$235.23
Heavy - RHD	50mm	200 - 400kg	SUZ010C	1	\$235.23
Heavy - LHD	50mm	200 - 400kg	SUZ011C	1	\$235.22

• SUZ010 are staggered height for Japan Spec vehicles, SUZ011 are equal height for Euro spec vehicles

PANHARD ROD

Adjustable Panhard Rod PANHARD018 1 \$300.57

BRAKE HOSE

Extended Brake Hose Left side BHOSE009 1 \$65.34

SPACER KIT

Extended Headlight Sensor Bracket 1211K 1 \$13.07

• Must install BHOSE009 and 1211K when fitting 12760GR

SUSPENSION KIT

Medium - Nitro Gas SUZ010BKG \$1254.53

Heavy - Nitro Gas SUZ010CKG \$1254.53

SUSPENSION KIT CONTENTS

Shock Absorbers

Extended Brake Hose

Front Crossmember Drop Brackets

Coil Springs

Extended Headlight Sensor Bracket



OPTIONS AVAILABLE FOR THIS VEHICLE - SEE PAGE 370



PRODUCT DESCRIPTION

PART NO.

QTY
Required

RETAIL
ea Incl GST

ACCESSORIES TO SUIT SUZUKI JIMNY

STEEL WINCH BULL BARS

Commercial Deluxe

BBCD063

\$1985.00

• Winch with Steel Cable and Roller Fairlead is not suitable - Use Winch with Synthetic Rope and Alloy Hawse only

DIFF BREATHER KIT

Diff Breather Kit

IDIFFBRE

\$114.00

Suzuki Jimny

SN413
1998 to 2018

PRODUCT DESCRIPTION

PART NO.

QTY
RequiredRETAIL
ea Incl GST

SUSPENSION TO SUIT SUZUKI JIMNY

FRONT SUSPENSION

SHOCK ABSORBER

Nitro Gas - Performance			12759GR	2	\$143.75
-------------------------	--	--	----------------	---	----------

STEERING DAMPER

Foam Cell		Includes Adaptor Kit	3521S	1	\$156.82
-----------	--	----------------------	--------------	---	----------

COIL SPRINGS

Medium	Est. Lift	Additional Load	SUZ009B	1	\$235.23
--------	-----------	-----------------	----------------	---	----------

OFFSET CASTER BUSH KIT

Offset Bush Kit Rubber	2 Degree offset		1146RK	1	\$117.62
------------------------	-----------------	--	---------------	---	----------

REAR SUSPENSION

SHOCK ABSORBER

Nitro Gas - Performance			12760GR	2	\$143.75
-------------------------	--	--	----------------	---	----------

COIL SPRINGS

Medium - Japan Spec	Est. Lift	Additional Load	SUZ010B	1	\$235.23
---------------------	-----------	-----------------	----------------	---	----------

Medium - Euro Spec	50mm	0 -200kg	SUZ011B	1	\$235.23
--------------------	------	----------	----------------	---	----------

• SUZ010B are staggered height for Japan Spec vehicles, SUZ011B are equal height for Euro spec vehicles

SUSPENSION KIT

Medium - Nitro Gas			SUZ009BKG		\$1045.44
--------------------	--	--	------------------	--	-----------

• Specify rear Coil Springs when ordering

SUSPENSION KIT CONTENTS

Shock Absorbers

Coil Springs

Suzuki Sierra

SJ80 (Coil)
1997+



PRODUCT DESCRIPTION

PART NO.

QTY
Required

RETAIL
ea Incl GST

SUSPENSION TO SUIT SUZUKI SIERRA

FRONT SUSPENSION

COIL SPRINGS	Est. Lift	Additional Load			
Medium	35mm	0-40kg	SUZ007B	1	\$235.23
OFFSET CASTER BUSH KIT					
Offset Bush Kit Rubber		2 Degree offset	1146RK	1	\$117.62

REAR SUSPENSION

COIL SPRINGS	Est. Lift	Additional Load			
Medium	35mm	0-200kg	SUZ008B	1	\$235.23



Suzuki Sierra

Samurai LJ, SJ (Leaf)
1981+

PRODUCT DESCRIPTION

PART NO.

QTY
RequiredRETAIL
ea Incl GST

SUSPENSION TO SUIT SUZUKI SIERRA

FRONT SUSPENSION

SHOCK ABSORBER

Nitro Gas - Performance			12085GR	2	\$143.75
-------------------------	--	--	----------------	---	----------

LEAF SPRINGS

	Est. Lift	Additional Load			
Medium - Drivers Side	50mm	0 - 50kg	SUZ001BD/S	1	\$196.02
Medium - Near Side	50mm	0 - 50kg	SUZ001BN/S	1	\$196.02

STEERING DAMPER

Foam Cell			3530	1	\$156.82
-----------	--	--	-------------	---	----------

U-BOLTS

U-Bolt Kit		Drivers side	654UBK	1	\$39.21
U-Bolt Kit		Near side	655UBK	1	\$39.21

POLYURETHANE SPRING BUSHES

Bush Kit			734UK	1	\$78.41
----------	--	--	--------------	---	---------

REAR SUSPENSION

SHOCK ABSORBER

Nitro Gas - Performance			12086GR	2	\$143.75
-------------------------	--	--	----------------	---	----------

LEAF SPRINGS

	Est. Lift	Additional Load			
Medium	50mm	0 - 200kg	SUZ002B	2	\$235.23
Medium - Optional +20mm	50mm	0 - 200kg	SUZ002BD/S	1	\$235.23

- Optional D/S spring to offset uneven weight distribution, eg. Spare Wheel

U-BOLTS

U-Bolt Kit			655UBK	2	\$39.21
------------	--	--	---------------	---	---------

POLYURETHANE SPRING BUSHES

Bush Kit			734UK	1	\$78.41
----------	--	--	--------------	---	---------

HELPER SPRINGS

Load Plus Helper Springs			LP5	1	\$156.82
--------------------------	--	--	------------	---	----------

SUSPENSION KIT

Medium - Nitro Gas			SUZ001BKG		\$1751.12
--------------------	--	--	------------------	--	-----------

- Specify rear spring configuration when ordering

SUSPENSION KIT CONTENTS

Shock Absorbers

U-Bolts

Leaf Springs

Polyurethane Spring Bushes

Suzuki Grand Vitara

8/2005 to 2015



PRODUCT DESCRIPTION

PART NO.

QTY
Required

RETAIL
ea Incl GST

ACCESSORIES TO SUIT SUZUKI GRAND VITARA

STEEL WINCH BULL BARS - 2012 DIESEL MANUAL ONLY - NOT COMPATIBLE WITH V6 MODEL

Commercial Deluxe - Diesel Manual Only	BBCD046	\$1985.00
Protector - Diesel Manual Only - <i>While Stocks Last</i>	BBT046	\$2009.00

UNDERBODY PROTECTION

Engine Bay and Transmission - (2005 to 2015)	IUP011K	\$562.00
--	----------------	----------

DIFF BREATHER KIT

Diff Breather Kit	IDIFFBRE	\$114.00
-------------------	-----------------	----------





8/2005 to 2015

Suzuki Grand Vitara

PRODUCT DESCRIPTION

PART NO.

QTY
Required

RETAIL
ea Incl GST

SUSPENSION TO SUIT SUZUKI GRAND VITARA

FRONT SUSPENSION

SHOCK ABSORBER

Nitro Gas Strut - Performance	McPherson Strut	12721GR	2	\$235.23
-------------------------------	-----------------	----------------	---	----------

COIL SPRINGS

	Est. Lift	Additional Load			
Medium	40mm	0 - 50kg	SUZ019B	1	\$235.23
Heavy or Diesel, or 2.7L	40mm	50 - 100kg	SUZ019C	1	\$235.23

CAMBER CORRECTION

Camber Bolt Kit	ICAMBER14	1	\$26.14
-----------------	------------------	---	---------

REAR SUSPENSION

SHOCK ABSORBER

Nitro Gas - Performance	12722GR	2	\$143.75
-------------------------	----------------	---	----------

COIL SPRINGS

	Est. Lift	Additional Load			
Medium - SWB (GV3)	40mm	0 - 200kg	SUZ020A	1	\$235.23
Medium - LWB	40mm	0 - 200kg	SUZ020B	1	\$235.23
Heavy - LWB	40mm	200 - 400kg	SUZ020C	1	\$235.23

SUSPENSION KIT

Medium - Nitro Gas	SWB GV3	SUZ019AKG	\$1254.53
Medium - Nitro Gas	LWB	SUZ019BKG	\$1254.53
Heavy - Nitro Gas	LWB	SUZ019CKG	\$1254.53

- SWB refers 3 door vehicles, LWB refers 5 door vehicles
- Monocoque constructed vehicles such as Suzuki Grand Vitara can be subject to increased NVH (Noise) with upgraded suspension installed
- Specify front Coil Springs when ordering

SUSPENSION KIT CONTENTS

Shock Absorbers	Strut Shock Absorbers
Coil Springs	Camber Correction



Suzuki Grand Vitara

1988 to 7/2005



PRODUCT DESCRIPTION

PART NO.

QTY
Required

RETAIL
ea Incl GST

SUSPENSION TO SUIT SUZUKI GRAND VITARA

FRONT SUSPENSION

SHOCK ABSORBER

Nitro Gas Strut - Performance	Full replacement strut		12083GR	2	\$209.09
-------------------------------	------------------------	--	----------------	---	----------

COIL SPRINGS

	Est. Lift	Additional Load			
Medium - 4 Cyl Carb	35mm	0 - 50kg	SUZ005B	1	\$235.23
Medium - V6 / 4 Cyl Inj	35mm	0 - 50kg	SUZ015B	1	\$235.23
Medium - XL7	35mm	0 - 50kg	SUZ017B	1	\$235.23

CAMBER CORRECTION

Camber Bolt Kit			ICAMBER12	1	\$26.14
-----------------	--	--	------------------	---	---------

REAR SUSPENSION

SHOCK ABSORBER

Nitro Gas - Performance	SWB	12089GR	2	\$143.75
Nitro Gas - Performance	LWB	12658GR	2	\$143.75

COIL SPRINGS

	Est. Lift	Additional Load			
Medium - SWB	35mm	0 - 200kg	SUZ013B	1	\$235.23
Medium - LWB	35mm	0 - 200kg	SUZ016B	1	\$235.23
Medium - XL7	35mm	0 - 200kg	SUZ018B	1	\$235.23

SUSPENSION KIT

Medium - Nitro Gas	SWB	SUZ013BKG	\$1202.26
Medium - Nitro Gas	LWB	SUZ016BKG	\$1202.26
Medium - Nitro Gas	XL7	SUZ018BKG	\$1202.26

- SWB suits short wheel base vehicles
- LWB Suits long wheel base vehicles
- Specify front Coil Springs when ordering

SUSPENSION KIT CONTENTS

Shock Absorbers	Strut Shock Absorbers
Coil Springs	Camber Correction

Suzuki Vitara

1988+



PRODUCT DESCRIPTION

PART NO.

QTY
Required

RETAIL
ea Incl GST

SUSPENSION TO SUIT SUZUKI VITARA

FRONT SUSPENSION

SHOCK ABSORBER

Nitro Gas Strut - Performance	Full replacement strut	12083GR	2	\$209.09
-------------------------------	------------------------	----------------	---	----------

COIL SPRINGS

	Est. Lift	Additional Load		
Medium - SWB	35mm	0 - 50kg	SUZ003B	1
Medium - LWB	35mm	0 - 50kg	SUZ005B	1

CAMBER CORRECTION

Camber Bolt Kit		ICAMBER12	1	\$26.14
-----------------	--	------------------	---	---------

REAR SUSPENSION

SHOCK ABSORBER

Nitro Gas - Performance	SWB	12089GR	2	\$143.75
Nitro Gas - Performance	LWB	12658GR	2	\$143.75

COIL SPRINGS

	Est. Lift	Additional Load		
Medium - SWB	35mm	0 - 200kg	SUZ004B	1
Medium - LWB	35mm	0 - 200kg	SUZ006B	1

SUSPENSION KIT

Medium - Nitro Gas	SWB	SUZ003BKG		\$1202.26
Medium - Nitro Gas	LWB	SUZ005BKG		\$1202.26

- SWB suits short wheel base vehicles
- LWB Suits long wheel base vehicles

SUSPENSION KIT CONTENTS

Shock Absorbers	Strut Shock Absorbers
Coil Springs	Camber Correction



Toyota 4Runner

Gen 5, N280
2009+



PRODUCT DESCRIPTION

DATE AVAILABLE

PART NO.

QTY
RequiredRETAIL
ea Incl GST

ACCESSORIES TO SUIT TOYOTA 4RUNNER

STEEL WINCH BULL BARS

Raid Stubby Bull Bar*	Q2 2021	BBR078		\$848.00
-----------------------	---------	--------	--	----------

* Compatible with Ironman 4x4 Lightbars, refer below for available options

LIGHTING OPTIONS - TO SUIT RAID BULL BARS

75W Bright Sabre Single Row Lightbar 524mm (20") Straight	Q2 2021	ILBSR003BW	1	\$189.00
---	---------	------------	---	----------

STEEL SIDE STEPS

Raid Rock Slider	Q2 2021	SS078		\$848.00
------------------	---------	-------	--	----------

TOWING

Raid Rear Bumper*	Q2 2021	RTB078		\$950.00
-------------------	---------	--------	--	----------

* Compatible with Ironman 4x4 Cube Lights, refer below for available options

LIGHTING OPTIONS - TO SUIT RAID REAR BARS (4 CUBE LIGHTS PER VEHICLE)

20W Bright Cube Spot Beam LED Cube Light - 70 x 64mm (Each) - Clear	Q2 2021	ILED20B	2	\$59.00
20W Bright Cube Spot Beam LED Cube Light - 70 x 64mm (Each) - Amber	Q2 2021	ILED20BA	2	\$59.00
20W Bright Cube Flood Beam LED Cube Light - 70 x 64mm (Each) - Clear	Q2 2021	ILED20BF	2	\$59.00
20W Bright Cube Flood Beam LED Cube Light - 70 x 64mm (Each) - Amber	Q2 2021	ILED20BFA	2	\$59.00
20W Bright Cube Flood Beam LED Cube Light - 70 x 64mm (Each) - Red	Q2 2021	ILED20BFR	2	\$59.00

PREMIUM UNDERBODY PROTECTION

Engine Bay and Transmission for models without KDSS		UBP047		\$712.00
---	--	--------	--	----------

DIFF BREATHER KIT

Diff Breather Kit		IDIFFBRE		\$114.00
-------------------	--	----------	--	----------





Gen 4 and 5, N210-N280
2003+

Toyota 4Runner

PRODUCT DESCRIPTION

PART NO.

QTY
Required

RETAIL
ea Incl GST

SUSPENSION TO SUIT TOYOTA 4RUNNER

FRONT SUSPENSION

SHOCK ABSORBER

Nitro Gas Strut - Performance			12710GR	2	\$209.09
Foam Cell Strut - Performance			24710FE	2	\$235.23
Foam Cell Pro Strut - Performance			45710FE	2	\$365.91

• Height adjustable with Ironman 4x4 Strut Trim Packers.

COIL SPRINGS

	Est. Lift	Additional Load			
Light	30mm	0 - 50kg	TOY055B	1	\$235.23
Medium	45mm	0 - 50kg	TOY065B	1	\$235.23
Heavy	45mm	50 - 110kg	TOY065C	1	\$235.23

STRUT MOUNTS

Steel Strut Top			ISS001	2	\$78.41
-----------------	--	--	---------------	---	---------

TRIM PACKERS

5mm Strut Trim Packer	Nitro Gas / Foam Cell	HILFR05 / HILFR05F	2	\$26.14
10mm Strut Trim Packer	Nitro Gas / Foam Cell	HILFR10 / HILFR10F	2	\$26.14
15mm Strut Trim Packer	Nitro Gas / Foam Cell	HILFR15 / HILFR15F	2	\$26.14

• ONLY Compatible with Ironman 4x4 Struts (except Pro), lift height subject to 2:1 motion ratio. Unnecessary fitment may lift vehicle too high

CONTROL ARMS

Pro-Forge Upper Control Arms			UCA001FA	1	\$831.60
------------------------------	--	--	-----------------	---	----------

SPACER KIT

Sway Bar Spacer			1198K	1	\$91.48
Offset Sway Bar Bracket			1209K	1	\$130.68

REAR SUSPENSION

SHOCK ABSORBER

Nitro Gas - Comfort			12682GRC	2	\$143.75
Nitro Gas - Professional			12682GRP	2	\$143.75
Foam Cell - Comfort			24682FEC	2	\$209.09
Foam Cell - Professional			24682FEP	2	\$209.09
Foam Cell Pro - Comfort			45682FEC	2	\$287.50
Foam Cell Pro - Professional			45682FEP	2	\$287.50

COIL SPRINGS

	Est. Lift	Additional Load			
Light	30mm	0 - 300kg	TOY056A	1	\$235.23
Medium	45mm	0 - 300kg	TOY056B	1	\$235.23
Heavy	45mm	300kg - GVM	TOY056C	1	\$235.23
Air Bag Delete Kit			1218ADK	1	\$435.60

COIL SPACER

Polyurethane 20mm			LCPR20	2	\$26.14
Polyurethane 25mm			LCPR25	2	\$39.21

PANHARD ROD

Adjustable Panhard Rod			PANHARD015	1	\$300.57
------------------------	--	--	-------------------	---	----------

SWAY BAR LINK

Extended Sway Bar Link			SBEXT006	2	\$78.41
KDSS Spacer Brackets			1220K	1	\$133.10

SUSPENSION KIT

Light - Nitro Gas	TOY055AKG	\$1176.12
Light - Foam Cell	TOY055AKF	\$1359.08
Light - Foam Cell Pro	TOY055AKP	\$1907.93
Medium - Nitro Gas	TOY055BKG	\$1176.12
Medium - Foam Cell	TOY055BKF	\$1359.08
Medium - Foam Cell Pro	TOY055BKP	\$1907.93
Heavy - Nitro Gas	TOY055CKG	\$1176.12
Heavy - Foam Cell	TOY055CKF	\$1359.08
Heavy - Foam Cell Pro	TOY055CKP	\$1907.93

• Specify front Coil Springs when ordering

SUSPENSION KIT CONTENTS

Shock Absorbers	Strut Shock Absorbers
Coil Springs	Offset Sway Bar Bracket (Pro Kits Only)





PRODUCT DESCRIPTION

PART NO.

QTY
Required

RETAIL
ea Incl GST

SUSPENSION TO SUIT TOYOTA 4RUNNER

FRONT SUSPENSION

SHOCK ABSORBER

Nitro Gas Strut - Performance			12691GR	2	\$209.09
Foam Cell Strut - Performance			24691FE	2	\$235.23
Foam Cell Pro Strut - Performance			45691FE	2	\$365.91

• Height adjustable with Ironman 4x4 Strut Trim Packers.

COIL SPRINGS

	Est. Lift	Additional Load			
Medium	45mm	0 - 50kg	TOY038B	1	\$235.23
Heavy	45mm	50 - 110kg	TOY038C	1	\$235.23

STRUT MOUNTS

Steel Strut Top			ISST001	2	\$78.41
-----------------	--	--	----------------	---	---------

TRIM PACKERS

5mm Strut Trim Packer	Nitro Gas / Foam Cell	HILFR05 / HILFR05F	2	\$26.14
10mm Strut Trim Packer	Nitro Gas / Foam Cell	HILFR10 / HILFR10F	2	\$26.14
15mm Strut Trim Packer	Nitro Gas / Foam Cell	HILFR15 / HILFR15F	2	\$26.14

• ONLY Compatible with Ironman 4x4 Struts (except Pro), lift height subject to 2:1 motion ratio. Unnecessary fitment may lift vehicle too high

REAR SUSPENSION

SHOCK ABSORBER

Nitro Gas - Performance			12661GR	2	\$143.75
Foam Cell - Performance			24661FE	2	\$209.09
Foam Cell Pro - Performance			45661FE	2	\$287.50

COIL SPRINGS

	Est. Lift	Additional Load			
Light	30mm	0 - 200kg	TOY039A	1	\$235.23
Medium	45mm	0 - 300kg	TOY039B	1	\$235.23
Heavy	45mm	300kg - GVM	TOY039C	1	\$235.23

COIL SPACER

Polyurethane 20mm			LCF20	2	\$26.14
Polyurethane 30mm			LCF30	2	\$39.21

SUSPENSION KIT

Light - Nitro Gas	TOY038AKG	\$1176.12
Light - Foam Cell	TOY038AKF	\$1359.08
Light - Foam Cell Pro	TOY038AKP	\$1777.25
Medium - Nitro Gas	TOY038BKG	\$1176.12
Medium - Foam Cell	TOY038BKF	\$1359.08
Medium - Foam Cell Pro	TOY038BKP	\$1777.25
Heavy - Nitro Gas	TOY038BKG1	\$1176.12
Heavy - Foam Cell	TOY038BKF1	\$1359.08
Heavy - Foam Cell Pro	TOY038BKP1	\$1777.25

• Specify front Coil Springs when ordering

SUSPENSION KIT CONTENTS

Shock Absorbers	Strut Shock Absorbers
Coil Springs	

Toyota 4Runner



Gen 2 Surf, N130 V6 (Coil)
1990 to 1997

PRODUCT DESCRIPTION

PART NO.

QTY
Required

RETAIL
ea Incl GST

SUSPENSION TO SUIT TOYOTA 4RUNNER

FRONT SUSPENSION

SHOCK ABSORBER

Nitro Gas - Performance	12088GR	2	\$143.75
Foam Cell - Performance	24088FE	2	\$209.09

TORSION BAR

Uprated Torsion Bars	TOY026	1	\$392.04
----------------------	---------------	---	----------

• Minimum 60mm downward suspension travel required after adjustment.

STEERING DAMPER

Foam Cell	3533	1	\$156.82
-----------	-------------	---	----------

REAR SUSPENSION

SHOCK ABSORBER

Nitro Gas - Comfort	12637GRC	2	\$143.75
Nitro Gas - Performance	12637GR	2	\$143.75
Foam Cell - Comfort	24637FEC	2	\$209.09
Foam Cell - Performance	24637FE	2	\$209.09

COIL SPRINGS

	Est. Lift	Additional Load			
Medium	45mm	0 -200kg	TOY023B	1	\$235.23
Heavy	45mm	200kg - GVM	TOY023C	1	\$235.23

SUSPENSION KIT

Medium - Nitro Gas	TOY023BKG	\$1202.26
Medium - Foam Cell	TOY023BKF	\$1463.62
Heavy - Nitro Gas	TOY023CKG	\$1202.26
Heavy - Foam Cell	TOY023CKF	\$1463.62

SUSPENSION KIT CONTENTS

Shock Absorbers	Torsion Bars
Coil Springs	



Toyota 4Runner

Gen 1, N60 (Leaf)
1988 to 1997



PRODUCT DESCRIPTION

PART NO.

QTY
Required

RETAIL
ea Incl GST

SUSPENSION TO SUIT TOYOTA 4RUNNER

FRONT SUSPENSION

SHOCK ABSORBER

Nitro Gas - Performance		12088GR	2	\$143.75
Foam Cell - Performance		24088FE	2	\$209.09

TORSION BAR

Up-rated Torsion Bars		TOY026	1	\$392.04
-----------------------	--	---------------	---	----------

• Minimum 60mm downward suspension travel required after adjustment

STEERING DAMPER

Foam Cell		3533	1	\$156.82
-----------	--	-------------	---	----------

REAR SUSPENSION

SHOCK ABSORBER

Nitro Gas - Comfort		12650GRC	2	\$143.75
Nitro Gas - Performance		12650GR	2	\$143.75
Foam Cell - Comfort		24650FEC	2	\$209.09
Foam Cell - Performance		24650FE	2	\$209.09
Foam Cell - Professional		24650FEP	2	\$209.09

LEAF SPRINGS

	Est. Lift	Additional Load			
Medium	50mm	0 -300kg	TOY011B	2	\$352.84
Heavy	50mm	300kg - GVM	TOY011C	2	\$378.98

• 1200mm Leaf Length

U-BOLTS

U-Bolt Kit		437UBK	2	\$39.21
------------	--	---------------	---	---------

POLYURETHANE SPRING BUSHES

Bush Kit		733UK	1	\$65.34
----------	--	--------------	---	---------

GREASABLE SHACKLES AND PINS

Greasable Shackle	Straight Shackle	386	2	\$52.28
Greasable Shackle	Straight Shackle Extended 5mm	386-2	2	\$52.28
Greasable Pin		385	2	\$39.21

HELPER SPRINGS

Load Plus Helper Springs		LP2	1	\$156.82
Add-A-Leaf		ISL6010	1	\$156.82

SUSPENSION KIT

Medium - Nitro Gas		TOY011BKG		\$1816.46
Medium - Foam Cell		TOY011BKF		\$2077.82
Heavy - Nitro Gas		TOY011CKG		\$1868.73
Heavy - Foam Cell		TOY011CKF		\$2130.09

SUSPENSION KIT CONTENTS

Shock Absorbers	Torsion Bars	Polyurethane Spring Bushes
Leaf Springs	U-Bolts	



2019 to 2021

SUSPENSION TO SUIT

Toyota Rav4

PRODUCT DESCRIPTION

PART NO.

QTY
Required

RETAIL
ea Incl GST

SUSPENSION TO SUIT TOYOTA RAV4

FRONT SUSPENSION

COIL SPRINGS	Est. Lift	Additional Load	PART NO.	QTY	RETAIL
Comfort	35mm	0-50kg	TOY080A	1	\$235.23

REAR SUSPENSION

COIL SPRINGS	Est. Lift	Additional Load	PART NO.	QTY	RETAIL
Comfort	35mm	0-200kg	TOY082A	1	\$235.23



Toyota FJ Cruiser

2006+



PRODUCT DESCRIPTION

PART NO.

QTY
Required

RETAIL
ea Incl GST

ACCESSORIES TO SUIT TOYOTA FJ CRUISER

STEEL WINCH BULL BARS

Commercial Deluxe

BBCD037

\$1985.00

PREMIUM UNDERBODY PROTECTION

Engine Bay and Transmission

UBP047

\$712.00

UNDERBODY PROTECTION

Engine Bay and Transmission

IUP003K

\$562.00

DIFF BREATHER KIT

Diff Breather Kit

IDIFFBRE

\$114.00





2006+

Toyota FJ Cruiser

PRODUCT DESCRIPTION

PART NO.

QTY
Required

RETAIL
ea Incl GST

SUSPENSION TO SUIT TOYOTA FJ CRUISER

FRONT SUSPENSION

SHOCK ABSORBER

Nitro Gas Strut - Performance			12710GR	2	\$209.09
Foam Cell Strut - Performance			24710FE	2	\$235.23
Foam Cell Pro Strut - Performance			45710FE	2	\$365.91

- Height adjustable with Ironman 4x4 Strut Trim Packers

- Foam Cell Pro, must fit 1198K spacer for Sway Bar clearance

COIL SPRINGS

	Est. Lift	Additional Load			
Light	30mm	0 - 50kg	TOY055A	1	\$235.23
Medium	45mm	0 - 50kg	TOY055B	1	\$235.23
Heavy	45mm	50 - 110kg	TOY055C	1	\$235.23

STRUT MOUNTS

Steel Strut Top			ISST001	2	\$78.41
-----------------	--	--	----------------	---	---------

TRIM PACKERS

5mm Strut Trim Packer	Nitro Gas / Foam Cell	HILFR05 / HILFR05F	2	\$26.14
10mm Strut Trim Packer	Nitro Gas / Foam Cell	HILFR10 / HILFR10F	2	\$26.14
15mm Strut Trim Packer	Nitro Gas / Foam Cell	HILFR15 / HILFR15F	2	\$26.14

- ONLY Compatible with Ironman 4x4 Struts (except Pro), lift height subject to 2:1 motion ratio. Unnecessary fitment may lift vehicle too high

CONTROL ARMS

Pro-Forge Upper Control Arms			UCA001FA	1	\$831.60
------------------------------	--	--	-----------------	---	----------

SPACER KIT

Sway Bar Spacer			1198K	1	\$91.48
Offset Sway Bar Bracket			1209K	1	\$130.68

REAR SUSPENSION

SHOCK ABSORBER

Nitro Gas - Comfort			12682GRC	2	\$143.75
Nitro Gas - Performance			12682GR	2	\$143.75
Nitro Gas - Professional			12682GRP	2	\$143.75
Foam Cell - Comfort			24682FEC	2	\$209.09
Foam Cell - Performance			24682FE	2	\$209.09
Foam Cell - Professional			24682FEP	2	\$209.09
Foam Cell Pro - Comfort			45682FEC	2	\$287.50
Foam Cell Pro - Performance			45682FE	2	\$287.50
Foam Cell Pro - Professional			45682FEP	2	\$287.50

COIL SPRINGS

	Est. Lift	Additional Load			
Light	40mm	0 - 300kg	TOY056A	1	\$235.23
Medium	50mm	0 - 300kg	TOY056B	1	\$235.23
Heavy	50mm	300kg - GVM	TOY069B	1	\$235.23

PANHARD ROD

Adjustable Panhard Rod			PANHARD015	1	\$300.57
------------------------	--	--	-------------------	---	----------

SWAY BAR LINK

Extended Sway Bar Link			SBEXT006	2	\$78.41
------------------------	--	--	-----------------	---	---------

BUMP STOP

Internal Rubber Cone			1218R	2	\$121.00
----------------------	--	--	--------------	---	----------

SUSPENSION KIT

Light - Nitro Gas	TOY055AKG	\$1176.12
Light - Foam Cell	TOY055AKF	\$1359.08
Light - Foam Cell Pro	TOY055AKP	\$1907.93
Medium - Nitro Gas	TOY055BKG	\$1176.12
Medium - Foam Cell	TOY055BKF	\$1359.08
Medium - Foam Cell Pro	TOY055BKP	\$1907.93
Heavy - Nitro Gas	TOY055CKG	\$1176.12
Heavy - Foam Cell	TOY055CKF	\$1359.08
Heavy - Foam Cell Pro	TOY055CKP	\$1907.93

- Specify front Coil Springs when ordering

SUSPENSION KIT CONTENTS

Shock Absorbers	Strut Shock Absorbers
Coil Springs	Offset Sway Bar Bracket (Pro Kits Only)

Toyota Fortuner

2015 to 9/2020
(Facelift) 2020+



PRODUCT DESCRIPTION

PART NO.

QTY Required

RETAIL ea Incl GST

ACCESSORIES TO SUIT TOYOTA FORTUNER

STEEL WINCH BULL BARS

Commercial Deluxe - (2015 to 2/2020 Only)	BBCD053	\$1985.00
Commercial Deluxe - (2020+ facelift Only) - Q2 2021	BBCD081	\$1985.00
Protector - (2015 to 2/2020 Only)	BBT053	\$2009.00
Proguard No Loop - (2015 to 2/2020 Only) - <i>While Stocks Last</i>	BBT053-NL	\$1641.00
Proguard No Loop - (2020+ facelift Only) Q2 2021	BBT081-NL	\$1641.00
Proguard Single Loop Kit - (2015 to 2/2020 Only)	BB053-SL	\$297.00
Proguard Single Loop Kit - (2020+ facelift Only) Q2 2021	BB081-SL	\$297.00
Proguard Triple Loop Kit - (2015 to 2/2020 Only)	BB053-TL	\$357.00
Proguard Triple Loop Kit - (2020+ facelift Only) Q2 2021	BB081-TL	\$357.00

STEEL SIDE STEPS AND RAILS

Side Steps	SS053	\$851.00
Side Rails	SS053 RAIL	\$280.00
Side Steps and Rails	SSR053	\$1022.00

RECOVERY POINTS - IRONMAN 4X4 BULL BAR ONLY

Recovery Points - 5000kg Rating (Pair)	IRP051	\$200.00
--	--------	----------

PREMIUM UNDERBODY PROTECTION

Engine Bay and Transmission	UBP051	\$712.00
-----------------------------	--------	----------

SNORKEL

2.8L Diesel	ISNORKEL053	\$387.00
-------------	-------------	----------

SEAT COVER

Canvas Comfort - Front	ICSC053F	\$400.00
Canvas Comfort - Rear	ICSC053R	\$400.00

DIFF BREATHER KIT

Diff Breather Kit	IDIFFBRE	\$114.00
-------------------	----------	----------



Toyota Fortuner

2015+

PRODUCT DESCRIPTION

PART NO.

QTY
RequiredRETAIL
ea Incl GST

SUSPENSION TO SUIT TOYOTA FORTUNER

FRONT SUSPENSION

SHOCK ABSORBER

Nitro Gas Strut - Performance			12730GR	2	\$209.09
Foam Cell Strut - Performance			24730FE	2	\$235.23
Foam Cell Pro Strut - Performance			45730FE	2	\$365.91

- Height adjustable with Ironman 4x4 Strut Trim Packers

- Operating clearance to sway bar can be increased by installing 1210K offset sway bar bracket

COIL SPRINGS

	Est. Lift	Additional Load			
Medium	30mm	0 - 50kg	TOY055A	1	\$235.23
Heavy	40mm	50 - 110kg	TOY055B	1	\$235.23

STRUT MOUNTS

Steel Strut Top			ISST001	2	\$78.41
-----------------	--	--	----------------	---	---------

TRIM PACKERS

5mm Strut Trim Packer	Nitro Gas / Foam Cell	HILFR05 / HILFR05F	2	\$26.14
10mm Strut Trim Packer	Nitro Gas / Foam Cell	HILFR10 / HILFR10F	2	\$26.14
15mm Strut Trim Packer	Nitro Gas / Foam Cell	HILFR15 / HILFR15F	2	\$26.14

- ONLY Compatible with Ironman 4x4 Struts (except Pro), lift height subject to 2:1 motion ratio. Unnecessary fitment may lift vehicle too high

CONTROL ARMS

Pro-Forge Upper Control Arms			UCA001FA	1	\$831.60
------------------------------	--	--	-----------------	---	----------

SWAY BAR

Offset Sway Bar Bracket			1210K	1	\$130.68
-------------------------	--	--	--------------	---	----------

REAR SUSPENSION

SHOCK ABSORBER

Nitro Gas - Comfort			12743GRC	2	\$143.75
Nitro Gas - Performance			12743GR	2	\$143.75
Foam Cell - Comfort			24743FEC	2	\$209.09
Foam Cell - Performance			24743FE	2	\$209.09
Foam Cell Pro - Comfort			45743FEC	2	\$287.50
Foam Cell Pro - Performance			45743FE	2	\$287.50

COIL SPRINGS

	Est. Lift	Additional Load			
Standard	0mm	0 - 200kg	TOY017S	1	\$235.23
Medium	30mm	0 - 200kg	TOY017A	1	\$235.23
Heavy	40mm	100 - 300kg	TOY017B	1	\$235.23

- Possible driveline vibration may occur, use 1192K Centre Bearing Spacer Kit

SPACER KIT

Centre Bearing Spacer Kit			1192K	1	\$26.14
---------------------------	--	--	--------------	---	---------

SUSPENSION KIT

Medium - Nitro Gas	TOY017AKG1	\$1202.26
Medium - Foam Cell	TOY017AKF1	\$1385.21
Medium - Foam Cell Pro	TOY017AKP1	\$1934.07
Heavy - Nitro Gas	TOY017BKG1	\$1202.26
Heavy - Foam Cell	TOY017BKF1	\$1385.21
Heavy - Foam Cell Pro	TOY017BKP1	\$2025.54

- Specify front Coil Springs when ordering

- Possible driveline vibration may occur if raised above 40mm

SUSPENSION KIT CONTENTS

Shock Absorbers

Strut Shock Absorbers

Offset Sway Bar Bracket (Pro Kits Only)

Coil Springs

Centre Bearing Spacer Kit

Toyota Fortuner

2004 to 2015



PRODUCT DESCRIPTION

PART NO.

QTY
Required

RETAIL
ea Incl GST

ACCESSORIES TO SUIT TOYOTA FORTUNER

STEEL WINCH BULL BARS

Commercial	BBC030	\$1598.00
Commercial Deluxe	BBCD030	\$1985.00
Protector	BBT030	\$2009.00
Proguard No Loop	BBT030-NL	\$1641.00
Proguard Single Loop Kit	BB030-SL	\$297.00
Proguard Triple Loop Kit	BB030-TL	\$357.00
DIFF BREATHER KIT		
Diff Breather Kit	IDIFFBRE	\$114.00



Toyota Fortuner

2004 to 2015



PRODUCT DESCRIPTION

PART NO.

QTY
RequiredRETAIL
ea Incl GST

SUSPENSION TO SUIT TOYOTA FORTUNER

FRONT SUSPENSION

SHOCK ABSORBER

Nitro Gas Strut - Performance			12710GR	2	\$209.09
Foam Cell Strut - Performance			24710FE	2	\$235.23
Foam Cell Pro Strut - Performance			45710FE	2	\$365.91

- Height adjustable with Ironman 4x4 Strut Trim Packers

- Foam Cell Pro, must fit 1198K spacer for Sway Bar clearance

COIL SPRINGS

	Est. Lift	Additional Load			
Standard	0mm	0 - 50kg	TOY038B	1	\$235.23
Medium	45mm	0 - 50kg	TOY055A	1	\$235.23
Heavy	45mm	50 - 110kg	TOY055B	1	\$235.23

STRUT MOUNTS

Steel Strut Top			ISST001	2	\$78.41
-----------------	--	--	----------------	---	---------

TRIM PACKERS

5mm Strut Trim Packer	Nitro Gas / Foam Cell	HILFR05 / HILFR05F	2	\$26.14
10mm Strut Trim Packer	Nitro Gas / Foam Cell	HILFR10 / HILFR10F	2	\$26.14
15mm Strut Trim Packer	Nitro Gas / Foam Cell	HILFR15 / HILFR15F	2	\$26.14

- ONLY Compatible with Ironman 4x4 Struts (except Pro), lift height subject to 2:1 motion ratio. Unnecessary fitment may lift vehicle too high

CONTROL ARMS

Pro-Forge Upper Control Arms			UCA001FA	1	\$831.60
------------------------------	--	--	-----------------	---	----------

SPACER KIT

Sway Bar Spacer			1198K	1	\$91.48
-----------------	--	--	--------------	---	---------

REAR SUSPENSION

SHOCK ABSORBER

Nitro Gas - Comfort			12743GRC	2	\$143.75
Nitro Gas - Performance			12743GR	2	\$143.75
Foam Cell - Comfort			24743FEC	2	\$209.09
Foam Cell - Performance			24743FE	2	\$209.09
Foam Cell Pro - Comfort			45743FEC	2	\$287.50
Foam Cell Pro - Performance			45743FE	2	\$287.50

COIL SPRINGS

	Est. Lift	Additional Load			
Standard	0mm	0 - 200kg	TOY017S	1	\$235.23
Light	40mm	0 - 200kg	TOY017A	1	\$235.23
Medium	45mm	0 - 300kg	TOY017B	1	\$235.23

SPACER KIT

Centre Bearing Spacer Kit			1192K	1	\$26.14
---------------------------	--	--	--------------	---	---------

SUSPENSION KIT

Standard - Nitro Gas	TOY017SKG	\$1176.12
Standard - Foam Cell	TOY017SKF	\$1868.73
Standard - Foam Cell Pro	TOY017SKP	\$1894.86
Light - Nitro Gas	TOY017AKG	\$1176.12
Light - Foam Cell	TOY017AKF	\$1359.08
Light - Foam Cell Pro	TOY017AKP	\$1868.73
Medium - Nitro Gas	TOY017BKG	\$1176.12
Medium - Foam Cell	TOY017BKF	\$1359.08
Medium - Foam Cell Pro	TOY017BKP	\$1868.73

- Specify front Coil Springs when ordering

SUSPENSION KIT CONTENTS

Shock Absorbers	Strut Shock Absorbers
Coil Springs	Sway Bar Spacer (Pro Kits Only)



PRODUCT DESCRIPTION

PART NO.

QTY
Required

RETAIL
ea Incl GST

SUSPENSION TO SUIT TOYOTA HIACE

FRONT SUSPENSION

SHOCK ABSORBER

Foam Cell Strut - Performance	Left Hand Side		24840FE LH	1	\$261.36
Foam Cell - Performance	Right Hand Side		24840FE RH	1	\$261.36

COIL SPRINGS

Medium	Est. Lift 40mm	Additional Load 0 - 50kg	TOY072B	1	\$235.23
--------	-------------------	-----------------------------	----------------	---	----------

REAR SUSPENSION

SHOCK ABSORBER

Foam Cell - Comfort			24842FEC	2	\$209.09
Foam Cell - Performance			24842FE	2	\$209.09

LEAF SPRINGS

Medium - (Single Stage Parabolic)	Est. Lift 45mm	Additional Load 0 - 300kg	TOY073B	2	\$548.86
Heavy - (Dual Stage Parabolic)	45mm	300kg - GVM	TOY073C	2	\$548.86

U-BOLTS

U-Bolt Kit			1106UBK	2	\$39.21
------------	--	--	----------------	---	---------

POLYURETHANE SPRING BUSHES

Bush Kit			1154UK	1	\$217.80
----------	--	--	---------------	---	----------

SUSPENSION KIT

Medium - Foam Cell			TOY074BKF		\$2570.04
Heavy - Foam Cell			TOY074CKF		\$2570.04

SUSPENSION KIT CONTENTS

Shock Absorbers	Coil Springs	U-Bolts
Strut Shock Absorbers	Leaf Springs	Polyurethane Spring Bushes



Toyota Hiace

Series 200
2005 to 2019

PRODUCT DESCRIPTION

PART NO.

QTY
RequiredRETAIL
ea Incl GST

SUSPENSION TO SUIT TOYOTA HIACE

FRONT SUSPENSION

SHOCK ABSORBER

Nitro Gas - Performance	12667GR	2	\$143.75
Foam Cell - Performance	24667FE	2	\$209.09

TORSION BAR

Uprated Torsion Bars	TOY042	1	\$416.87
----------------------	--------	---	----------

- Minimum 60mm downward suspension travel required after adjustment

REAR SUSPENSION

SHOCK ABSORBER

Nitro Gas - Comfort	12805GRC	2	\$143.75
Nitro Gas - Performance	12805GR	2	\$143.75
Foam Cell - Performance	24805FE	2	\$209.09

LEAF SPRINGS

Heavy	Est. Lift 40mm	Additional Load 400kg - GVM	TOY044C	2	\$483.52
-------	-------------------	--------------------------------	---------	---	----------

U-BOLTS

U-Bolt Kit	415UBK	2	\$39.21
------------	--------	---	---------

POLYURETHANE SPRING BUSHES

Bush Kit	728UKL	1	\$78.41
----------	--------	---	---------

HELPER SPRINGS

Load Plus Helper Springs	LP3	1	\$156.82
Add-A-Leaf	ISL6010	1	\$156.82

SUSPENSION KIT

Heavy - Nitro Gas	TOY044CKG		\$1881.80
-------------------	-----------	--	-----------

SUSPENSION KIT CONTENTS

Shock Absorbers

Torsion Bars

Polyurethane Spring Bushes

Leaf Springs

U-Bolts



PRODUCT DESCRIPTION

DATE AVAILABLE

PART NO.

QTY
Required

RETAIL
ea Incl GST

ACCESSORIES TO SUIT TOYOTA HILUX

STEEL WINCH BULL BARS

Commercial Deluxe*		BBCD076 *	\$2021.00
Commercial Deluxe†		BBCD076-NB †	\$2021.00
Proguard No Loop*	Q2 2021	BBT076-NL *	\$1641.00
Proguard Single Loop Kit*	Q2 2021	BB076-SL *	\$297.00
Proguard Triple Loop Kit*	Q2 2021	BB076-TL *	\$357.00

* Suits wide body models only - Hi-Rider - 4x2 SR & SR5 / Dual Cab 4x4 - Workmate, SR & SR5 / Extra Cab 4x4 - Workmate, SR & SR5 - 1860mm Width

† Suits narrow body models only - Single Cab 4x4 Workmate, SR / Dual Cab 4x2 Workmate / Single Cab 4x2 Workmate - 1780mm Width

STEEL SIDE STEPS AND RAILS

Side Steps - Fits Dual Cab models only		SS051	\$851.00
Side Rails		SS051 RAIL	\$280.00
Side Steps and Rails - Fits Dual Cab models only		SSR051	\$1022.00

TOWING

Class 4 Towbar - Compatible with Factory Rear Bumper		TB051	\$523.00
Rear Protection Towbar - Full Rear Bumper Replacement*	With Side Tubes	RTB051-SP	\$1196.00
Rear Protection Towbar Plates (Pair)		RTBPLATE001	\$131.00
Towbar Wiring Loom - Plug and Play		ITBL051	\$248.00

RECOVERY POINTS - IRONMAN 4X4 BULL BAR ONLY

Recovery Points (Pair)		IRP051	\$200.00
------------------------	--	--------	----------

LOCKSAFE DRAWER SYSTEMS

Twin Drawers - 1300mm		ITD1300	\$1469.00
Single Drawer - 1300mm		ISD1300	\$891.00
Wing Kit - 1300mm*		ITDW051	\$351.00

* Designed to suit factory tubs, will not suit ute liner without modification.

SNORKEL

2.8L Turbo Diesel		ISNORKEL051	\$387.00
Narrow Body Model		ISNORKEL076N	\$387.00

LONG RANGE FUEL TANK

135L* - 2.8L Diesel 4WD Dual Cab		TANK051	\$1129.00
----------------------------------	--	---------	-----------

* Usable volume may differ to the stated tank capacity

PREMIUM UNDERBODY PROTECTION

Engine Bay and Transmission		UBP051	\$712.00
-----------------------------	--	--------	----------

EXHAUST SYSTEM

3" Exhaust Upgrade 2.8L 2016+ - DPF Back - While Stocks Last		IEX051	\$770.00
--	--	--------	----------

CANOPY - ABS PLASTIC (SIDE LIFT UP WINDOWS AND CENTRAL LOCKING REAR DOOR) - FITS 4X4 AND 4X2 DUAL CAB MODELS

A DECK			
Pre-Primed - A Deck		CANOPY015-P †	\$3143.00*
Super White (040)		CANOPY015-SW †	\$3743.00
Attitude Black (218) - While Stocks Last		CANOPY015-AB	\$2253.00
Dark Grey (1G3) - While Stocks Last		CANOPY015-DG	\$2253.00
Blue Metallic / Nebular Blue (8X2) - While Stocks Last		CANOPY015-BM	\$2253.00
ABS Canopy Rack Feet		IRRFEETABS14	\$250.00

* See Page 33 and 34 for 1.4m Roof Rack options and pricing.

* Pre-primed canopies, plus colour coding. († With central locking)



8/2020+

Toyota Hilux

PRODUCT DESCRIPTION	DATE AVAILABLE	PART NO.	QTY Required	RETAIL ea Incl GST
---------------------	----------------	----------	-----------------	-----------------------

CANOPY - SMOOTH FINISH FIBREGLASS PINNACLE (SIDE LIFT UP WINDOWS AND CENTRAL LOCKING REAR DOOR) - FITS 4X4 AND 4X2 DUAL CAB MODELS

A DECK

Pre-Primed		CANFIBRE051-P		\$2783.00*
Super White (040)		CANFIBRE051-SW		\$3297.00
Silver Metallic / Silver Sky (1D6)		CANFIBRE051-SM		\$3297.00
Attitude Black (218)		CANFIBRE051-AB		\$3297.00
Dark Grey (1G3)		CANFIBRE051-DG		\$3297.00

• Fits A Deck 4x4 and 4x2 Dual Cab models

* Pre-primed canopies, plus colour coding.

SEAT COVER

Canvas Comfort - Front		ICSC051F		\$400.00
Canvas Comfort - Rear		ICSC051R		\$400.00

DIFF BREATHER KIT

Diff Breather Kit		IDIFFBRE		\$114.00
-------------------	--	----------	--	----------





PRODUCT DESCRIPTION

PART NO.

QTY
RequiredRETAIL
ea Incl GST

SUSPENSION TO SUIT TOYOTA HILUX

FRONT SUSPENSION

SHOCK ABSORBER

Nitro Gas Strut - Performance			12730GR	2	\$209.09
Foam Cell Strut - Performance			24730FE	2	\$235.23
Foam Cell Pro Strut - Performance			45730FE	2	\$365.91

• Height adjustable with Ironman 4x4 Strut Trim Packers

• Operating clearance to sway bar can be increased by installing 1210K offset sway bar bracket

COIL SPRINGS

	Est. Lift	Additional Load			
Standard	0mm	0 - 50kg	TOY055A	1	\$235.23
Light	20mm	0 - 50kg	TOY055B	1	\$235.23
Light	45mm	0 - 50kg	TOY065A	1	\$235.23
Medium	30mm	0 - 50kg	TOY055C	1	\$235.23
Medium - with Accessories	45mm	0 - 50kg	TOY065B	1	\$235.23
Heavy	45mm	50 - 110kg	TOY065C	1	\$235.23

STRUT MOUNTS

Steel Strut Top			ISST001	2	\$78.41
-----------------	--	--	----------------	---	---------

TRIM PACKERS

5mm Strut Trim Packer	Nitro Gas / Foam Cell	HILFR05 / HILFR05F	2	\$26.14
10mm Strut Trim Packer	Nitro Gas / Foam Cell	HILFR10 / HILFR10F	2	\$26.14
15mm Strut Trim Packer	Nitro Gas / Foam Cell	HILFR15 / HILFR15F	2	\$26.14

• ONLY Compatible with Ironman 4x4 Struts (except Pro), lift height subject to 2:1 motion ratio. Unnecessary fitment may lift vehicle too high

CONTROL ARMS

Pro-Forge Upper Control Arms			UCA001FA	1	\$831.60
------------------------------	--	--	-----------------	---	----------

SWAY BAR

33mm Sway Bar			ISB80F	1	\$548.86
Offset Sway Bar Bracket			1210K	1	\$130.68

REAR SUSPENSION

SHOCK ABSORBER

Nitro Gas - Comfort			12081GRC	2	\$143.75
Nitro Gas - Performance			12081GR	2	\$143.75
Foam Cell - Comfort			24081FEC	2	\$209.09
Foam Cell - Performance			24081FE	2	\$209.09
Foam Cell - Professional			24081FEP	2	\$209.09
Foam Cell Pro - Comfort			45081FEC	2	\$287.50
Foam Cell Pro - Performance			45081FE	2	\$287.50
Foam Cell Pro - Professional			45081FEP	2	\$287.50

LEAF SPRINGS

	Est. Lift	Additional Load			
Light	40mm	0 - 100kg	TOY077A	2	\$352.84
Medium	45mm	0 - 200kg	TOY077B	2	\$352.84
Heavy	45mm	200 - 400kg	TOY077C	2	\$378.98
Extra Heavy	45mm	400kg - GVM	TOY077D	2	\$378.98

• New spring pins 387-1 may be required, as OEM orientation may require cutting for removal

U-BOLTS

U-Bolt Kit			437UBKL	2	\$39.21
------------	--	--	----------------	---	---------

POLYURETHANE SPRING BUSHES

Bush Kit			767UK	1	\$78.41
----------	--	--	--------------	---	---------

SPACER KIT

Centre Bearing Spacer Kit			1192K	1	\$26.14
Headlight Adjustment Leaf Spring Bracket (SR5 Only)			1213K	1	\$16.94

GREASABLE SHACKLES AND PINS

Greasable Shackle			1155	2	\$52.28
Non-Greasable Pin			387-1	2	\$26.14

HELPER SPRINGS

Load Plus Helper Springs			LP2	1	\$156.82
Add-A-Leaf			ISL6010	1	\$156.82



8/2020+

Toyota Hilux

PRODUCT DESCRIPTION

PART NO.

QTY
Required

RETAIL
ea Incl GST

SUSPENSION KIT

Light - Nitro Gas	TOY077AKG	\$1855.66
Light - Foam Cell	TOY077AKF	\$2038.61
Light - Foam Cell Pro	TOY077AKP	\$2587.47
Medium - Nitro Gas	TOY077BKG	\$1855.66
Medium - Foam Cell	TOY077BKF	\$2038.61
Medium - Foam Cell Pro	TOY077BKP	\$2587.47
Heavy - Nitro Gas	TOY077CKG	\$1907.93
Heavy - Foam Cell	TOY077CKF	\$2090.88
Heavy - Foam Cell Pro	TOY077CKP	\$2639.74
Extra Heavy - Nitro Gas	TOY077DKG	\$1907.93
Extra Heavy - Foam Cell	TOY077DKF	\$2090.88
Extra Heavy - Foam Cell Pro	TOY077DKP	\$2639.74

• Specify Front Coil Springs when ordering

SUSPENSION KIT CONTENTS

Shock Absorbers	Coil Springs	U-Bolts	Non-Greasable Pins
Strut Shock Absorbers	Leaf Springs	Polyurethane Spring Bushes	Offset Sway Bar Bracket (Pro Kits Only)



OPTIONS AVAILABLE FOR THIS VEHICLE - SEE PAGE 371



PRODUCT DESCRIPTION

PART NO.

QTY
RequiredRETAIL
ea Incl GST

ACCESSORIES TO SUIT TOYOTA HILUX

STEEL WINCH BULL BARS SUITS

Commercial - (2015 to 4/2018 Only) *	BBC051 *	\$1598.00
Commercial - (5/2018 to 7/2020 Only) *	BBC065 *	\$1598.00
Commercial - (Narrow Body Only) †	BBC065-NB †	\$1598.00
Commercial Deluxe - (2015 to 4/2018 Only) *	BBCD051 *	\$2021.00
Commercial Deluxe - (5/2018 to 7/2020 Only) *	BBCD065 *	\$2021.00
Polished Alloy - (2015 to 4/2018 Only) *	BBA051 *	\$2517.00
Polished Alloy - (5/2018 to 7/2020 Only) *	BBA065 *	\$2517.00
Proguard No Loop - (2015 to 4/2018 Only) *	BBT051-NL *	\$1670.00
Proguard No Loop - (5/2018 to 7/2020 Only) *	BBT065-NL *	\$1670.00
Proguard Single Loop Kit - (2015 to 4/2018 Only) *	BB051-SL *	\$297.00
Proguard Single Loop Kit - (5/2018 to 7/2020 Only) *	BB065-SL *	\$297.00
Proguard Triple Loop Kit - (2015 to 4/2018 Only) *	BB051-TL *	\$357.00
Proguard Triple Loop Kit - (5/2018 to 7/2020 Only) *	BB065-TL *	\$357.00

* Winch with Steel Cable and Roller Fairlead is not suitable - Use Winch with Synthetic Rope and Alloy Hawse only

* Suits wide body models only - Hi-Rider - 4x2 SR & SR5 / Dual Cab 4x4 - Workmate, SR & SR5 / Extra Cab 4x4 - Workmate, SR & SR5

† Suits narrow body models only - Single Cab 4x4 Workmate, SR / Dual Cab 4x2 Workmate / Single Cab 4x2 Workmate

STEEL SIDE STEPS AND RAILS

Side Steps - Fits Dual Cab models only	SS051	\$851.00
Side Rails	SS051 RAIL	\$280.00
Side Steps and Rails - Fits Dual Cab models only	SSR051	\$1022.00

TOWING

Class 4 Towbar - Compatible with Factory Rear Bumper	TB051	\$523.00
Rear Protection Towbar - Full Rear Bumper Replacement	RTB051	\$1196.00
Rear Protection Towbar - Full Rear Bumper Replacement* - With Side Tubes	RTB051-P	\$1196.00
Rear Protection Towbar Plates (Pair)	RTBPLATE001	\$131.00
Towbar Wiring Loom - Plug and Play	ITBL051	\$248.00

RECOVERY POINTS - IRONMAN 4X4 BULL BAR ONLY

Recovery Points - 5000kg Rating (Pair)	IRP051	\$200.00
--	--------	----------

LOCKSAFE DRAWER SYSTEMS

Twin Drawers - 1300mm	ITD1300	\$1469.00
Single Drawer - 1300mm	ISD1300	\$891.00
Wing Kit - 1300mm*	ITDW051	\$351.00

* Designed to suit factory tubs, will not suit ute liner without modification.

SNORKEL

2.8L Turbo Diesel	ISNORKEL051	\$387.00
-------------------	-------------	----------

LONG RANGE FUEL TANK

135L* - 2.8L Diesel 4WD	TANK051	\$1129.00
-------------------------	---------	-----------

* Usable volume may differ to the stated tank capacity

PREMIUM UNDERBODY PROTECTION

Engine Bay and Transmission	UBP051	\$712.00
-----------------------------	--------	----------

EXHAUST SYSTEM

3" Exhaust Upgrade 2.8L 2016+ - DPF Back - While Stocks Last	IEX051	\$770.00
--	--------	----------



Revo
2015 to 4/2018
(Facelift) 5/2018 to 7/2020

ACCESSORIES TO SUIT

Toyota Hilux

PRODUCT DESCRIPTION

PART NO.

QTY
Required

RETAIL
ea Incl GST

CANOPY - ABS PLASTIC (SIDE LIFT UP WINDOWS AND CENTRAL LOCKING REAR DOOR) - FITS 4X4 AND 4X2 DUAL CAB MODELS

A DECK

Pre-Primed - A Deck	CANOPY015-P †	\$3143.00*
Super White (040)	CANOPY015-SW †	\$3743.00
Attitude Black (218) - <i>While Stocks Last</i>	CANOPY015-AB	\$2253.00
Dark Grey (1G3) - <i>While Stocks Last</i>	CANOPY015-DG	\$2253.00
Blue Metallic / Nebular Blue (8X2) - <i>While Stocks Last</i>	CANOPY015-BM	\$2253.00
ABS Canopy Rack Feet	IRRFETABS14	\$250.00

• See Page 33 and 34 for 1.4m Roof Rack options and pricing.

* Pre-primed canopies, plus colour coding. († With central locking)

J DECK

Super White (040)	CANOPY017-SW	\$3743.00
-------------------	--------------	-----------

CANOPY - SMOOTH FINISH FIBREGLASS PINNACLE (SIDE LIFT UP WINDOWS AND CENTRAL LOCKING REAR DOOR) - FITS 4X4 AND 4X2 DUAL CAB MODELS

A DECK

Pre-Primed	CANFIBRE051-P	\$2783.00*
Super White (040)	CANFIBRE051-SW	\$3297.00
Silver Metallic / Silver Sky (1D6)	CANFIBRE051-SM	\$3297.00
Attitude Black (218)	CANFIBRE051-AB	\$3297.00
Dark Grey (1G3)	CANFIBRE051-DG	\$3297.00

• Fits A Deck 4x4 and 4x2 Dual Cab models

* Pre-primed canopies, plus colour coding.

SEAT COVER

Canvas Comfort - Front	ICSC051F	\$400.00
Canvas Comfort - Rear	ICSC051R	\$400.00

DIFF BREATHER KIT

Diff Breather Kit	IDIFFBRE	\$114.00
-------------------	----------	----------





PRODUCT DESCRIPTION

PART NO.

QTY
RequiredRETAIL
ea Incl GST

SUSPENSION TO SUIT TOYOTA HILUX

FRONT SUSPENSION

SHOCK ABSORBER

Nitro Gas Strut - Performance			12730GR	2	\$209.09
Foam Cell Strut - Performance			24730FE	2	\$235.23
Foam Cell Pro Strut - Performance			45730FE	2	\$365.91

• Height adjustable with Ironman 4x4 Strut Trim Packers

• Operating clearance to sway bar can be increased by installing 1210K offset sway bar bracket

COIL SPRINGS

	Est. Lift	Additional Load			
Standard	0mm	0 - 50kg	TOY055A	1	\$235.23
Light	20mm	0 - 50kg	TOY055B	1	\$235.23
Light	45mm	0 - 50kg	TOY065A	1	\$235.23
Medium	30mm	0 - 50kg	TOY055C	1	\$235.23
Medium - with Accessories	45mm	0 - 50kg	TOY065B	1	\$235.23
Heavy	45mm	50 - 110kg	TOY065C	1	\$235.23

STRUT MOUNTS

Steel Strut Top			ISST001	2	\$78.41
-----------------	--	--	---------	---	---------

TRIM PACKERS

5mm Strut Trim Packer	Nitro Gas / Foam Cell	HILFR05 / HILFR05F	2	\$26.14
10mm Strut Trim Packer	Nitro Gas / Foam Cell	HILFR10 / HILFR10F	2	\$26.14
15mm Strut Trim Packer	Nitro Gas / Foam Cell	HILFR15 / HILFR15F	2	\$26.14

• ONLY Compatible with Ironman 4x4 Struts (except Pro), lift height subject to 2:1 motion ratio. Unnecessary fitment may lift vehicle too high

CONTROL ARMS

Pro-Forge Upper Control Arms			UCA001FA	1	\$831.60
------------------------------	--	--	----------	---	----------

SWAY BAR

33mm Sway Bar			ISB80F	1	\$548.86
Offset Sway Bar Bracket			1210K	1	\$130.68

REAR SUSPENSION

SHOCK ABSORBER

Nitro Gas - Comfort			12081GRC	2	\$143.75
Nitro Gas - Performance			12081GR	2	\$143.75
Foam Cell - Comfort			24081FEC	2	\$209.09
Foam Cell - Performance			24081FE	2	\$209.09
Foam Cell - Professional			24081FEP	2	\$209.09
Foam Cell Pro - Comfort			45081FEC	2	\$287.50
Foam Cell Pro - Performance			45081FE	2	\$287.50
Foam Cell Pro - Professional			45081FEP	2	\$287.50

LEAF SPRINGS

	Est. Lift	Additional Load			
Light	40mm	0 - 100kg	TOY077A	2	\$352.84
Medium	45mm	0 - 200kg	TOY077B	2	\$352.84
Heavy	45mm	200 - 400kg	TOY077C	2	\$378.98
Extra Heavy	45mm	400kg - GVM	TOY077D	2	\$378.98

• New spring pins 387-1 may be required, as OEM orientation may require cutting for removal

U-BOLTS

U-Bolt Kit			437UBKL	2	\$39.21
------------	--	--	---------	---	---------

POLYURETHANE SPRING BUSHES

Bush Kit			767UK	1	\$78.41
----------	--	--	-------	---	---------

SPACER KIT

Centre Bearing Spacer Kit			1192K	1	\$26.14
Headlight Adjustment Leaf Spring Bracket (SR5 Only)			1213K	1	\$16.94

GREASABLE SHACKLES AND PINS

Greasable Shackle			1155	2	\$52.28
Non-Greasable Pin			387-1	2	\$26.14

HELPER SPRINGS

Load Plus Helper Springs			LP2	1	\$156.82
Add-A-Leaf			ISL6010	1	\$156.82



Revo
2015 to 4/2018
(Facelift) 5/2018 to 7/2020

SUSPENSION TO SUIT

Toyota Hilux

PRODUCT DESCRIPTION

PART NO.

QTY
Required

RETAIL
ea Incl GST

SUSPENSION KIT

Light - Nitro Gas	TOY077AKG	\$1855.66
Light - Foam Cell	TOY077AKF	\$2038.61
Light - Foam Cell Pro	TOY077AKP	\$2587.47
Medium - Nitro Gas	TOY077BKG	\$1855.66
Medium - Foam Cell	TOY077BKF	\$2038.61
Medium - Foam Cell Pro	TOY077BKP	\$2587.47
Heavy - Nitro Gas	TOY077CKG	\$1907.93
Heavy - Foam Cell	TOY077CKF	\$2090.88
Heavy - Foam Cell Pro	TOY077CKP	\$2639.74
Extra Heavy - Nitro Gas	TOY077DKG	\$1907.93
Extra Heavy - Foam Cell	TOY077DKF	\$2090.88
Extra Heavy - Foam Cell Pro	TOY077DKP	\$2639.74

• Specify Front Coil Springs when ordering

SUSPENSION KIT CONTENTS

Shock Absorbers	Coil Springs	U-Bolts	Non-Greasable Pins
Strut Shock Absorbers	Leaf Springs	Polyurethane Spring Bushes	Offset Sway Bar Bracket (Pro Kits Only)



OPTIONS AVAILABLE FOR THIS VEHICLE - SEE PAGE 371



PRODUCT DESCRIPTION

PART NO.

QTY
RequiredRETAIL
ea Incl GST

ACCESSORIES TO SUIT TOYOTA HILUX

STEEL WINCH BULL BARS

Commercial - (3/2005 to 9/2011 Only)	BBC002	\$1569.00
Commercial - (10/2011 to 2015 Only)	BBC033	\$1569.00
Commercial Deluxe - (3/2005 to 9/2011 Only)	BBCD002	\$1985.00
Commercial Deluxe - (10/2011 to 2015 Only)	BBCD033	\$1985.00
Protector - (3/2005 to 9/2011 Only) - <i>While Stocks Last</i>	BBT002	\$2009.00
Protector - (10/2011 to 2015 Only) - <i>While Stocks Last</i>	BBT033	\$2009.00

STEEL SIDE STEPS AND RAILS

Side Steps - Fits Dual Cab models only	SS033	\$851.00
Side Steps and Rails - Fits Dual Cab models only	SSR033	\$1022.00

RECOVERY POINTS - IRONMAN 4X4 BULL BAR ONLY

Recovery Points - 5000kg Rating (Pair)	IRP033	\$200.00
--	--------	----------

LOCKSAFE DRAWER SYSTEMS

Twin Drawers - 1300mm	ITD1300	\$1469.00
Single Drawer - 1300mm	ISD1300	\$891.00
Wing Kit - 1300mm*	ITDW024	\$351.00

*Designed to suit factory tubs, will not suit ute liner without modification.

SNORKEL

3L D4D TDi / 4L Petrol V6	ISNORKEL001	\$387.00
---------------------------	-------------	----------

LONG RANGE FUEL TANK

145L* - Diesel and Petrol 4WD only	TANK002	\$1129.00
------------------------------------	---------	-----------

* Usable volume may differ to the stated tank capacity

PREMIUM UNDERBODY PROTECTION

Engine Bay and Transmission	UBP033	\$712.00
-----------------------------	--------	----------

UNDERBODY PROTECTION

Engine Bay and Transmission	IUP001K	\$562.00
-----------------------------	---------	----------

CANOPY TRADE STYLE FIBREGLASS (SIDE LIFT UP WINDOWS) - FITS 4X4 AND 4X2 DUAL CAB MODELS

Canopy - Round Profile (Incl. roof rail system) Colour coded Toyota white	CANFIBRE001	\$3297.00
---	-------------	-----------

CANOPY - ABS PLASTIC (SIDE LIFT UP WINDOWS) - FITS 4X4 AND 4X2 DUAL CAB MODELS

J DECK		
Pre-Primed - J Deck	CANOPY002-P	\$3143.00*
Round Profile - J Deck	CANOPY002A	\$3743.00

* Pre-primed canopies, plus colour coding.

SEAT COVER

Canvas Comfort - Front	ICSC033F	\$400.00
Canvas Comfort - Rear	ICSC033R	\$400.00

DIFF BREATHER KIT

Diff Breather Kit	IDIFFBRE	\$114.00
-------------------	----------	----------





Vigo
3/2005 to 9/2011
(Facelift) 10/2011 to 2015

PRODUCT DESCRIPTION	PART NO.	QTY Required	RETAIL ea Incl GST
---------------------	----------	-----------------	-----------------------

SUSPENSION TO SUIT TOYOTA HILUX

FRONT SUSPENSION

SHOCK ABSORBER

Nitro Gas Strut - Performance	12710GR	2	\$209.09
Foam Cell Strut - Performance	24710FE	2	\$235.23
Foam Cell Pro Strut - Performance	45710FE	2	\$365.91

- Height adjustable with Ironman 4x4 Strut Trim Packers
- Foam Cell Pro, must fit 1198K spacer for Sway Bar clearance

COIL SPRINGS

	Est. Lift	Additional Load			
Light	40mm	0 - 50kg	TOY055A	1	\$235.23
Medium	45mm	0 - 50kg	TOY055B	1	\$235.23
Heavy	45mm	50 - 110kg	TOY055C	1	\$235.23

STRUT MOUNTS

Steel Strut Top	ISST001	2	\$78.41
-----------------	---------	---	---------

TRIM PACKERS

5mm Strut Trim Packer	Nitro Gas / Foam Cell	HILFR05 / HILFR05F	2	\$26.14
10mm Strut Trim Packer	Nitro Gas / Foam Cell	HILFR10 / HILFR10F	2	\$26.14
15mm Strut Trim Packer	Nitro Gas / Foam Cell	HILFR15 / HILFR15F	2	\$26.14

- ONLY Compatible with Ironman 4x4 Struts (except Pro), lift height subject to 2:1 motion ratio. Unnecessary fitment may lift vehicle too high

CONTROL ARMS

Pro-Forge Upper Control Arms	UCA001FA	1	\$831.60
------------------------------	----------	---	----------

SPACER KIT

Sway Bar Spacer	1198K	1	\$91.48
-----------------	-------	---	---------

REAR SUSPENSION

SHOCK ABSORBER

Nitro Gas - Comfort	12650GRC	2	\$143.75
Nitro Gas - Performance	12650GR	2	\$143.75
Nitro Gas Extra Long - Comfort	12081GRC	2	\$143.75
Nitro Gas Extra Long - Performance	12081GR	2	\$143.75
Foam Cell - Comfort	24650FEC	2	\$209.09
Foam Cell - Performance	24650FE	2	\$209.09
Foam Cell Extra Long - Comfort	24081FEC	2	\$209.09
Foam Cell Extra Long - Performance	24081FE	2	\$209.09
Foam Cell Extra Long - Professional	24081FEP	2	\$209.09
Foam Cell Pro - Comfort	45650FEC	2	\$287.50
Foam Cell Pro - Performance	45650FE	2	\$287.50
Foam Cell Pro Extra Long - Comfort	45081FEC	2	\$287.50
Foam Cell Pro Extra Long - Performance	45081FE	2	\$287.50
Foam Cell Pro Extra Long - Professional	45081FEP	2	\$287.50

LEAF SPRINGS

	Est. Lift	Additional Load			
Light	45mm	0 - 100kg	TOY057A	2	\$352.84
Medium	45mm	0 - 200kg	TOY057B	2	\$352.84
Heavy	45mm	200 - 400kg	TOY057C	2	\$378.98
Extra Heavy	45mm	400kg - GVM	TOY057D	2	\$378.98

U-BOLTS

U-Bolt Kit	437UBK	2	\$39.21
U-Bolt Kit Extra long	Suits TOY057A and TOY057D Spring 437UBKL	2	\$39.21

POLYURETHANE SPRING BUSHES

Bush Kit	767UK	1	\$78.41
----------	-------	---	---------

GREASABLE SHACKLES AND PINS

Greasable Shackle	386-3	2	\$52.28
Non-Greasable Pin	387-1	2	\$26.14

HELPER SPRINGS

Load Plus Helper Springs	LP2	1	\$156.82
Add-A-Leaf	ISL6010	1	\$156.82

LISTING
CONTINUED
OVER THE
PAGE



Toyota Hilux

Vigo
3/2005 to 9/2011
(Facelift) 10/2011 to 2015



PRODUCT DESCRIPTION

PART NO.

QTY
Required

RETAIL
ea Incl GST

SUSPENSION KIT

Light - Nitro Gas	TOY057AKG	\$1803.39
Light - Foam Cell	TOY057AKF	\$1986.34
Light - Foam Cell Pro	TOY057AKP	\$2495.99
Medium - Nitro Gas	TOY057BKG	\$1803.39
Medium - Foam Cell	TOY057BKF	\$1986.34
Medium - Foam Cell Pro	TOY057BKP	\$2495.99
Heavy - Nitro Gas	TOY057CKG	\$1855.66
Heavy - Foam Cell	TOY057CKF	\$2038.61
Heavy - Foam Cell Pro	TOY057CKP	\$2548.26
Extra Heavy - Nitro Gas	TOY057DKG	\$1855.66
Extra Heavy - Foam Cell	TOY057DKF	\$2038.61
Extra Heavy - Foam Cell Pro	TOY057DKP	\$2548.26

• Specify Front Coil Springs when ordering

SUSPENSION KIT CONTENTS

Shock Absorbers	Coil Springs	U-Bolts
Strut Shock Absorbers	Leaf Springs	Polyurethane Spring Bushes



OPTIONS AVAILABLE FOR THIS VEHICLE - SEE PAGE 372

Toyota Hilux

Low Ride 2WD
2005+

PRODUCT DESCRIPTION

PART NO.

QTY
RequiredRETAIL
ea Incl GST

SUSPENSION TO SUIT TOYOTA HILUX

FRONT SUSPENSION

SHOCK ABSORBER

Nitro Gas Strut - Performance	Left Hand Side	12764GR LH	1	\$209.09
Nitro Gas Strut - Performance	Right Hand Side	12764GR RH	1	\$209.09

- Height adjustable with Ironman 4x4 Strut Trim Packers.

COIL SPRINGS

	Est. Lift	Additional Load		
Medium	40mm	0 - 50kg	TOY067B	1

TRIM PACKERS

5mm Strut Trim Packer	Nitro Gas	HILFR05	2	\$26.14
10mm Strut Trim Packer	Nitro Gas	HILFR10	2	\$26.14
15mm Strut Trim Packer	Nitro Gas	HILFR15	2	\$26.14

- Only compatible with Ironman 4x4 Struts, lift height subject to 2:1 motion ratio. Unnecessary fitment may lift vehicle too high

REAR SUSPENSION

SHOCK ABSORBER

Nitro Gas - Comfort		12650GRC	2	\$143.75
Nitro Gas - Performance		12650GR	2	\$143.75
Foam Cell - Comfort		24650FEC	2	\$209.09
Foam Cell - Performance		24650FE	2	\$209.09
Foam Cell - Professional		24650FEP	2	\$209.09

LEAF SPRINGS

	Est. Lift	Additional Load		
Medium	45mm	0 - 200kg	TOY068B	2
Heavy	45mm	200 - 400kg	TOY068C	2

U-BOLTS

U-Bolt Kit		415UBK	2	\$39.21
------------	--	---------------	---	---------

POLYURETHANE SPRING BUSHES

Bush Kit	(14mm Front Bolt)	767UK	1	\$78.41
Bush Kit	(23mm Front Pin with Side Plate)	1151UK	1	\$78.41

GREASABLE SHACKLES AND PINS

Greasable Shackle		386-3	2	\$52.28
Non-Greasable Pin		387-1	2	\$26.14

- 14mm Pin

HELPER SPRINGS

Load Plus Helper Springs		LP2	1	\$156.82
Add-A-Leaf		ISL6010	1	\$156.82

SUSPENSION KIT

Medium - Nitro Gas		TOY068BKG		\$1803.39
Heavy - Nitro Gas		TOY068CKG		\$1855.66

- Specify Leaf Springs front bush I/D before ordering

SUSPENSION KIT CONTENTS

Shock Absorbers
Leaf SpringsTorsion Bars
U-Bolts

Polyurethane Spring Bushes

Toyota Hilux

Tiger
1997 to 2004



PRODUCT DESCRIPTION

PART NO.

QTY
Required

RETAIL
ea Incl GST

ACCESSORIES TO SUIT TOYOTA HILUX

STEEL WINCH BULL BARS

Commercial Deluxe - (2001 to 2004 Only)

BBCD001

\$1985.00

LOCKSAFE DRAWER SYSTEMS

Twin Drawers - 1300mm

ITD1300

\$1469.00

Single Drawer - 1300mm

ISD1300

\$891.00

Wing Kit - 1300mm (SR-SR5)*

ITDW023

\$351.00

**Designed to suit factory tubs, will not suit ute liner without modification.*

DIFF BREATHER KIT

Diff Breather Kit

IDIFFBRE

\$114.00



Toyota Hilux

Tiger 107, 108, 110, 111, 167
1997 to 2005

PRODUCT DESCRIPTION

PART NO.

QTY
RequiredRETAIL
ea Incl GST

SUSPENSION TO SUIT TOYOTA HILUX

FRONT SUSPENSION

SHOCK ABSORBER

Nitro Gas - Performance	12088GR	2	\$143.75
Foam Cell - Performance	24088FE	2	\$209.09

TORSION BAR

Uprated Torsion Bars	TOY026	1	\$392.04
----------------------	--------	---	----------

- Minimum 60mm downward suspension travel required after adjustment

STEERING DAMPER

Foam Cell	3533	1	\$156.82
-----------	------	---	----------

- Check clearance to engine sump when fitting steering damper

REAR SUSPENSION

SHOCK ABSORBER

Nitro Gas - Comfort	12081GRC	2	\$143.75
Nitro Gas - Performance	12081GR	2	\$143.75
Foam Cell - Comfort	24081FEC	2	\$209.09
Foam Cell - Performance	24081FE	2	\$209.09
Foam Cell - Professional	24081FEP	2	\$209.09

LEAF SPRINGS

	Est. Lift	Additional Load			
Light	40mm	0-100kg	TOY027A	2	\$352.84
Medium	40mm	0-200kg	TOY027B	2	\$352.84
Heavy	40mm	200kg - GVM	TOY027C	2	\$378.98

- 1300mm Leaf Length

U-BOLTS

U-Bolt Kit		437UBK	2	\$39.21
U-Bolt Kit Extra long	Suits TOY027A Spring	437UBKL	2	\$39.21

POLYURETHANE SPRING BUSHES

Bush Kit		758UK	1	\$78.41
----------	--	-------	---	---------

GREASABLE SHACKLES AND PINS

Greasable Shackle	Stepped Shackle	386-1	2	\$52.28
Non-Greasable Pin		387-1	2	\$26.14

HELPER SPRINGS

Load Plus Helper Springs		LP2	1	\$156.82
Add-A-Leaf		ISL6010	1	\$156.82

SUSPENSION KIT

Light - Nitro Gas	TOY027AKG	\$1829.52
Light - Foam Cell	TOY027AKF	\$2090.88
Medium - Nitro Gas	TOY027BKG	\$1829.52
Medium - Foam Cell	TOY027BKF	\$2090.88
Heavy - Nitro Gas	TOY027CKG	\$1881.80
Heavy - Foam Cell	TOY027CKF	\$2143.16

SUSPENSION KIT CONTENTS

Shock Absorbers	Torsion Bars	Polyurethane Spring Bushes
Leaf Springs	U-Bolts	

Toyota Hilux

Solid Front Axle
11/1983 to 11/1997



PRODUCT DESCRIPTION

PART NO.

QTY
Required

RETAIL
ea Incl GST

SUSPENSION TO SUIT TOYOTA HILUX

FRONT SUSPENSION

SHOCK ABSORBER

Nitro Gas - Comfort			12639GRC	2	\$143.75
Nitro Gas - Performance			12639GR	2	\$143.75
Foam Cell - Performance			24639FE	2	\$209.09

LEAF SPRINGS

	Est. Lift	Additional Load			
Medium - Drivers Side (Petrol)	50mm	0 - 50kg	TOY010BD/S	1	\$196.02
Medium - Near Side (Petrol)	50mm	0 - 50kg	TOY010BN/S	1	\$196.02
Heavy - Drivers Side (Diesel)	50mm	0 - 100kg	TOY010CD/S	1	\$196.02
Heavy - Near Side (Diesel)	50mm	0 - 100kg	TOY010CN/S	1	\$196.02

• Check clearance to drag link / u-bolt, ADL106 may be required

STEERING DAMPER

Foam Cell			3521	1	\$156.82
-----------	--	--	-------------	---	----------

U-BOLTS

Drivers Side U-Bolt Kit			678UBK	1	\$39.21
Near Side U-Bolt Kit			437UBK	1	\$39.21

POLYURETHANE SPRING BUSHES

Bush Kit			732UK	1	\$65.34
----------	--	--	--------------	---	---------

STEERING ARMS

Drop Drag Link			ADL106	1	\$261.36
----------------	--	--	---------------	---	----------

GREASABLE SHACKLES AND PINS

Greasable Shackle			384	2	\$65.34
Greasable Pin			385	2	\$39.21

REAR SUSPENSION

SHOCK ABSORBER

Nitro Gas - Comfort			12650GRC	2	\$143.75
Nitro Gas - Performance			12650GR	2	\$143.75
Foam Cell - Comfort			24650FEC	2	\$209.09
Foam Cell - Performance			24650FE	2	\$209.09
Foam Cell - Professional			24650FEP	2	\$209.09

LEAF SPRINGS

	Est. Lift	Additional Load			
Medium	50mm	0 - 300kg	TOY011B	2	\$352.84
Heavy	50mm	300kg - GVM	TOY011C	2	\$378.98

U-BOLTS

U-Bolt Kit			437UBK	2	\$39.21
------------	--	--	---------------	---	---------

POLYURETHANE SPRING BUSHES

Bush Kit			733UK	1	\$65.34
----------	--	--	--------------	---	---------

GREASABLE SHACKLES AND PINS

Greasable Shackle			386	2	\$52.28
Greasable Shackle		Extended 5mm	386-2	2	\$52.28
Greasable Pin			385	2	\$39.21

HELPER SPRINGS

Load Plus Helper Springs			LP2	1	\$156.82
Add-A-Leaf			ISL6010	1	\$156.82

SUSPENSION KIT

Medium - Nitro Gas			TOY010BKG2		\$1960.20
Medium - Foam Cell			TOY010BKF2		\$2221.56
Heavy - Nitro Gas			TOY010CKG2		\$2012.48
Heavy - Foam Cell			TOY010CKF2		\$2273.84

• Specify front Leaf Springs when ordering

SUSPENSION KIT CONTENTS

Shock Absorbers	U-Bolts
Leaf Springs	Polyurethane Spring Bushes

Toyota Hilux

Solid Front Axle
1979 to 10/1983

PRODUCT DESCRIPTION

PART NO.

QTY
RequiredRETAIL
ea Incl GST

SUSPENSION TO SUIT TOYOTA HILUX

FRONT SUSPENSION

SHOCK ABSORBER

Nitro Gas - Comfort			12639GRC	2	\$143.75
Nitro Gas - Performance			12639GR	2	\$143.75
Foam Cell - Performance			24639FE	2	\$209.09

LEAF SPRINGS

	Est. Lift	Additional Load			
Medium - Drivers Side (Petrol)	50mm	0 - 50kg	TOY010BD/S	1	\$196.02
Medium - Near Side (Petrol)	50mm	0 - 50kg	TOY010BN/S	1	\$196.02
Heavy - Drivers Side (Diesel)	50mm	0 - 100kg	TOY010CD/S	1	\$196.02
Heavy - Near Side (Diesel)	50mm	0 - 100kg	TOY010CN/S	1	\$196.02

• Check clearance to drag link / u-bolt, ADL106 may be required

STEERING DAMPER

Foam Cell			3521	1	\$156.82
-----------	--	--	-------------	---	----------

U-BOLTS

Drivers Side U-Bolt Kit			678UBK	1	\$39.21
Near Side U-Bolt Kit			437UBK	1	\$39.21

POLYURETHANE SPRING BUSHES

Bush Kit			732UK	1	\$65.34
----------	--	--	--------------	---	---------

STEERING ARMS

Drop Drag Link			ADL106	1	\$261.36
----------------	--	--	---------------	---	----------

GREASABLE SHACKLES AND PINS

Greasable Shackle			384	2	\$65.34
Greasable Pin			385	2	\$39.21

REAR SUSPENSION

SHOCK ABSORBER

Nitro Gas - Comfort			12636GRC	2	\$143.75
Nitro Gas - Performance			12636GR	2	\$143.75
Nitro Gas - Professional			12636GRP	2	\$143.75
Foam Cell - Comfort			24636FEC	2	\$209.09
Foam Cell - Performance			24636FE	2	\$209.09
Foam Cell - Professional			24636FEP	2	\$209.09

LEAF SPRINGS

	Est. Lift	Additional Load			
Medium	50mm	0 - 300kg	TOY011B	2	\$352.84
Heavy	50mm	300kg - GVM	TOY011C	2	\$378.98

U-BOLTS

U-Bolt Kit			437UBK	2	\$39.21
------------	--	--	---------------	---	---------

POLYURETHANE SPRING BUSHES

Bush Kit			733UK	1	\$65.34
----------	--	--	--------------	---	---------

GREASABLE SHACKLES AND PINS

Greasable Shackle			386	2	\$52.28
Greasable Shackle		Extended 5mm	386-2	2	\$52.28
Greasable Pin			385	2	\$39.21

HELPER SPRINGS

Load Plus Helper Springs			LP2	1	\$156.82
Add-A-Leaf			ISL6010	1	\$156.82

SUSPENSION KIT

Medium - Nitro Gas			TOY010BKG1		\$1960.20
Medium - Foam Cell			TOY010BKF1		\$2221.56
Heavy - Nitro Gas			TOY010CKG1		\$2012.48
Heavy - Foam Cell			TOY010CKF1		\$2273.84

• Specify front Leaf Springs when ordering

SUSPENSION KIT CONTENTS

Shock Absorbers	U-Bolts
Leaf Springs	Polyurethane Spring Bushes

Toyota Kluger

Kluger / Highlander
2020+



PRODUCT DESCRIPTION

PART NO.

QTY
Required

RETAIL
ea Incl GST

SUSPENSION TO SUIT TOYOTA KLUGER / HIGHLANDER

REAR SUSPENSION

COIL SPRINGS	Est. Lift	Additional Load	PART NO.	QTY	RETAIL
Heavy	40mm	200kg	TOY076C	1	\$235.23





200 Series (Facelift Mk II)
11/2015+

Toyota Landcruiser

PRODUCT DESCRIPTION	DATE AVAILABLE	PART NO.	QTY Required	RETAIL ea Incl GST
---------------------	----------------	----------	-----------------	-----------------------

ACCESSORIES TO SUIT TOYOTA LANDCRUISER

STEEL WINCH BULL BARS

Commercial - (GX models only - No Fog Lights)		BBC056		\$1569.00
Premium - 60.3mm Tube		BBP056-VX		\$2136.00
Polished Alloy		BBA056-VX		\$2516.00
Proguard No Loop		BBT056VX-NL		\$1670.00
Proguard Single Loop Kit		BB056-SL		\$297.00
Proguard Triple Loop Kit		BB056-TL		\$357.00
Driving Light Patch Loom		IPL056		\$30.00

• Winch with Steel Cable and Roller Fairlead is not suitable when front camera is used - Use Winch with Synthetic Rope and Alloy Hawse only

STEEL SIDE STEPS AND RAILS

Premium Side Steps - 60.3mm Tube (Suit non KDSS model)		SSP056		\$933.00
Premium Side Rails - 60.3mm Tube (Suit non KDSS model)		SSP056 RAIL		\$339.00
Premium Side Steps and Rails - 60.3mm Tube (Suit non KDSS model)		SSRP056		\$1129.00

RECOVERY POINTS - IRONMAN 4X4 BULL BAR ONLY

Recovery Points - 5000kg Rating (Pair) (Suit KDSS and non KDSS model)	Q2 2021	IRP056		\$200.00
---	---------	--------	--	----------

SNORKEL

Landcruiser 200 Series		ISNORKEL056		\$387.00
------------------------	--	-------------	--	----------

LOCKSAFE DRAWER SYSTEMS

Twin Drawers - 1000mm		ITD1000		\$1296.00
Single Drawer - 1000mm		ISD1000		\$783.00
Wing Kit - 1000mm (May impede access to rear 240V outlet)		ITDW020		\$270.00

BATTERY TRAY

Suits 12" Battery		IBTRAY056		\$149.00
-------------------	--	-----------	--	----------

STEEL ROOF RACKS

Cage Style - 1.8m x 1.25m		IRRCAGE18		\$744.00
Rooftop Tent Compatible - 1.8m x 1.25m		IRRTENT18		\$709.00
Trade Style - 1.8m x 1.25m (Open end)		IRRTRADE18		\$709.00

ALLOY ROOF RACKS

Cage Style - 1.8m x 1.25m		IRRCAGE18-ALLOY		\$1049.00
Trade Style - 1.8m x 1.25m (Open end)		IRRTRADE18-ALLOY		\$1033.00
Flat Rack - 1.8m x 1.25m		IRRTFLAT18-ALLOY		\$1019.00

ROOF RACK - MOUNTING KITS

Landcruiser 200 Mount Feet - 200mm (8 Feet)		IRRFEE TLC200		\$180.00
---	--	---------------	--	----------

PREMIUM UNDERBODY PROTECTION

Engine Bay and Transmission		UBP056		\$712.00
-----------------------------	--	--------	--	----------

EXHAUST SYSTEM

3" Exhaust Upgrade 4.5L V8 - DPF Back - <i>While Stocks Last</i>		IEX056		\$960.00
--	--	--------	--	----------

SEAT COVER

Canvas Comfort - Front		ICSC043F		\$400.00
Canvas Comfort - Rear		ICSC043R		\$400.00

DIFF BREATHER KIT

Diff Breather Kit		IDIFFBRE		\$114.00
-------------------	--	----------	--	----------

LISTING
CONTINUED
OVER THE
PAGE



PRODUCT DESCRIPTION

PART NO.

QTY
Required

RETAIL
ea Incl GST

SUSPENSION TO SUIT TOYOTA LANDCRUISER

FRONT SUSPENSION

SHOCK ABSORBER

Nitro Gas Strut - Performance			12720GR	2	\$235.23
Foam Cell Strut - Performance			24720FE	2	\$261.36
Foam Cell Pro Strut - Performance			45720FE	2	\$365.91

• Height adjustable with Ironman 4x4 Strut Trim Packers

COIL SPRINGS

	Est. Lift	Additional Load			
Standard	0mm	0-50kg	TOY063S	1	\$235.23
Light	25mm	0 - 50kg	TOY063A	1	\$235.23
Medium	50mm	0 - 50kg	TOY063B	1	\$235.23
Heavy	50mm	50 - 110kg	TOY063C	1	\$235.23

STRUT MOUNTS

Steel Strut Top			ISST004	2	\$78.41
-----------------	--	--	----------------	---	---------

TRIM PACKERS

5mm Strut Trim Packer	Nitro Gas / Foam Cell	HILFR05 / HILFR05F	2	\$26.14
10mm Strut Trim Packer	Nitro Gas / Foam Cell	HILFR10 / HILFR10F	2	\$26.14
15mm Strut Trim Packer	Nitro Gas / Foam Cell	HILFR15 / HILFR15F	2	\$26.14

• Only compatible with Ironman 4x4 Struts (except Pro), lift height subject to 2:1 motion ratio. Unnecessary fitment may lift vehicle too high

SWAY BAR

38mm Sway Bar	Non KDSS Models Only	ISB200F	1	\$548.86
---------------	----------------------	----------------	---	----------

CONTROL ARMS

Pro-Forge Upper Control Arms		UCA056FA	1	\$831.60
------------------------------	--	-----------------	---	----------

REAR SUSPENSION

SHOCK ABSORBER

Nitro Gas - Performance			12796GR	2	\$143.75
Foam Cell - Performance			24796FE	2	\$209.09
Foam Cell Pro - Performance			45796FE	2	\$287.50
Foam Cell Pro - Professional			45796FEP	2	\$287.50

COIL SPRINGS

	Est. Lift	Additional Load			
Standard	0mm	0 - 200kg	TOY064S	1	\$248.30
Light	25mm	0 - 200kg	TOY064A	1	\$248.30
Medium	50mm	0 - 300kg	TOY064B	1	\$248.30
Medium - with Accessories	50mm	100 - 400kg	TOY064EA	1	\$248.30
Heavy	50mm	400 - 800kg	TOY064C	1	\$261.36
Extra Heavy	50mm	800kg+	TOY064D	1	\$392.04

PANHARD ROD

Adjustable Panhard Rod			PANHARD016	1	\$300.57
------------------------	--	--	-------------------	---	----------

ADJUSTABLE TRAILING ARM

Upper Trailing Arm			UTA200	1	\$196.02
Lower Trailing Arm			LTA200	1	\$248.30

SWAY BAR

33mm Sway Bar	Non KDSS Models Only	ISB200R	1	\$548.86
---------------	----------------------	----------------	---	----------



200 Series (Facelift Mk II)
11/2015+

SUSPENSION TO SUIT

Toyota Landcruiser

PRODUCT DESCRIPTION

PART NO.

QTY
Required

RETAIL
ea Incl GST

SUSPENSION KIT

Light - Nitro Gas	TOY063AKG	\$1241.46
Light - Foam Cell	TOY063AKF	\$1424.42
Light - Foam Cell Pro	TOY063AKP	\$1790.32
Medium - Nitro Gas	TOY063BKG	\$1241.46
Medium - Foam Cell	TOY063BKF	\$1424.42
Medium - Foam Cell Pro	TOY063BKP	\$1790.32
Heavy - Nitro Gas	TOY063CKG	\$1254.53
Heavy - Foam Cell	TOY063CKF	\$1437.48
Heavy - Foam Cell Pro	TOY063CKP	\$1803.39

- All kits compatible with KDSS, refer KDSS instructions available at www.ironman4x4.com
- Specify front Coil Springs when ordering

SUSPENSION KIT CONTENTS

Shock Absorbers	Strut Shock Absorbers
Coil Springs	



OPTIONS AVAILABLE FOR THIS VEHICLE - SEE PAGE 373

Toyota Landcruiser

200 Series
11/2007 to 1/2012
(Facelift) 2/2012 to 10/2015



PRODUCT DESCRIPTION

PART NO.

QTY
Required

RETAIL
ea Incl GST

ACCESSORIES TO SUIT TOYOTA LANDCRUISER

STEEL WINCH BULL BARS

Commercial - (2/2012 to 9/2015) - <i>While Stocks Last</i>	BBC043	\$1569.00
Protector - (2/2012 to 9/2015) - <i>While Stocks Last</i>	BBT043	\$2009.00
Premium - 60.3mm Tube - (11/2007 to 1/2012)	BBP025	\$2098.00
Premium - 60.3mm Tube - (2/2012 to 9/2015)	BBP043	\$2098.00

RECOVERY POINTS - IRONMAN 4X4 BULL BAR ONLY

Recovery Points - 5000kg Rating (Pair) - KDSS and non KDSS models	IRP056	\$200.00
---	--------	----------

LOCKSAFE DRAWER SYSTEMS

Twin Drawers - 1000mm	ITD1000	\$1296.00
Single Drawer - 1000mm	ISD1000	\$783.00
Wing Kit - 1000mm (May impede access to rear 240V outlet)	ITDW020	\$270.00

SNORKEL

Landcruiser 200 Series	ISNORKEL010	\$387.00
------------------------	-------------	----------

STEEL ROOF RACKS

Cage Style - 1.8m x 1.25m	IRRCAGE18	\$744.00
Cage Style - 2.2m x 1.25m	IRRCAGE22	\$772.00
Rooftop Tent Compatible - 1.8m x 1.25m	IRRTENT18	\$709.00
Rooftop Tent Compatible - 2.2m x 1.25m	IRRTENT22	\$744.00
Trade Style - 1.8m x 1.25m (Open end)	IRRTRADE18	\$709.00
Trade Style - 2.2m x 1.25m (Open end)	IRRTRADE22	\$738.00

ALLOY ROOF RACKS

Cage Style - 1.8m x 1.25m	IRRCAGE18-ALLOY	\$1049.00
Cage Style - 2.2m x 1.25m	IRRCAGE22-ALLOY	\$1106.00
Trade Style - 1.8m x 1.25m (Open end)	IRRTRADE18-ALLOY	\$1033.00
Trade Style - 2.2m x 1.25m (Open end)	IRRTRADE22-ALLOY	\$1078.00
Flat Rack - 1.8m x 1.25m	IRRTFLAT18-ALLOY	\$1019.00

ROOF RACK - MOUNTING KITS

Landcruiser 200 Mount Feet - 200mm (8 Feet)	IRRFEETLC200	\$180.00
---	--------------	----------

UNDERBODY PROTECTION

Engine Bay and Transmission	IUP004K	\$636.00
Fuel Tank	IUP004F	\$307.00

• Fuel tank protection plates are not compatible with long range fuel tanks.

SEAT COVER

Canvas Comfort - Front	ICSC043F	\$400.00
Canvas Comfort - Rear	ICSC043R	\$400.00

DIFF BREATHER KIT

Diff Breather Kit	IDIFFBRE	\$114.00
-------------------	----------	----------





200 Series
11/2007 to 10/2015

Toyota Landcruiser

PRODUCT DESCRIPTION

PART NO.

QTY Required

RETAIL ea Incl GST

SUSPENSION TO SUIT TOYOTA LANDCRUISER

FRONT SUSPENSION

SHOCK ABSORBER

Nitro Gas Strut - Performance			12720GR	2	\$235.23
Foam Cell Strut - Performance			24720FE	2	\$261.36
Foam Cell Pro Strut - Performance			45720FE	2	\$365.91

• Height adjustable with Ironman 4x4 Strut Trim Packers

COIL SPRINGS

	Est. Lift	Additional Load			
Standard	0mm	0-50kg	TOY063S	1	\$235.23
Light	25mm	0 - 50kg	TOY063A	1	\$235.23
Medium	50mm	0 - 50kg	TOY063B	1	\$235.23
Heavy	50mm	50 - 110kg	TOY063C	1	\$235.23

STRUT MOUNTS

Steel Strut Top			ISST004	2	\$78.41
-----------------	--	--	----------------	---	---------

TRIM PACKERS

5mm Strut Trim Packer	Nitro Gas / Foam Cell	HILFR05 / HILFR05F	2	\$26.14
10mm Strut Trim Packer	Nitro Gas / Foam Cell	HILFR10 / HILFR10F	2	\$26.14
15mm Strut Trim Packer	Nitro Gas / Foam Cell	HILFR15 / HILFR15F	2	\$26.14

• ONLY Compatible with Ironman 4x4 Struts (except Pro), lift height subject to 2:1 motion ratio. Unnecessary fitment may lift vehicle too high

SWAY BAR

38mm Sway Bar	Non KDSS Models Only	ISB200F	1	\$548.86
---------------	----------------------	----------------	---	----------

REAR SUSPENSION

SHOCK ABSORBER

Nitro Gas - Performance			12796GR	2	\$143.75
Foam Cell - Performance			24796FE	2	\$209.09
Foam Cell Pro - Performance			45796FE	2	\$287.50
Foam Cell Pro - Professional			45796FEP	2	\$287.50

COIL SPRINGS

	Est. Lift	Additional Load			
Standard	0mm	0 - 200kg	TOY064S	1	\$248.30
Light	25mm	0 - 200kg	TOY064A	1	\$248.30
Medium	50mm	0 - 300kg	TOY064B	1	\$248.30
Medium - with Accessories	50mm	100 - 400kg	TOY064EA	1	\$248.30
Heavy	50mm	400kg - GVM	TOY064C	1	\$261.36
Extra Heavy	50mm	800kg+	TOY064D	1	\$392.04

PANHARD ROD

Adjustable Panhard Rod		PANHARD016	1	\$300.57
------------------------	--	-------------------	---	----------

ADJUSTABLE TRAILING ARM

Upper Trailing Arm		UTA200	1	\$196.02
Lower Trailing Arm		LTA200	1	\$248.30

SWAY BAR

33mm Sway Bar	Non KDSS Models Only	ISB200R	1	\$548.86
---------------	----------------------	----------------	---	----------

SUSPENSION KIT

Light - Nitro Gas	TOY063AKG	\$1241.46
Light - Foam Cell	TOY063AKF	\$1424.42
Light - Foam Cell Pro	TOY063AKP	\$1790.32
Medium - Nitro Gas	TOY063BKG	\$1241.46
Medium - Foam Cell	TOY063BKF	\$1424.42
Medium - Foam Cell Pro	TOY063BKP	\$1790.32
Heavy - Nitro Gas	TOY063CKG	\$1254.53
Heavy - Foam Cell	TOY063CKF	\$1437.48
Heavy - Foam Cell Pro	TOY063CKP	\$1803.39

• All kits compatible with KDSS, refer KDSS instructions available at www.ironman4x4.com

• Specify front Coil Springs when ordering

SUSPENSION KIT CONTENTS

Shock Absorbers	Strut Shock Absorbers
Coil Springs	



Toyota Landcruiser

PRODUCT DESCRIPTION

PART NO.

QTY
Required

RETAIL
ea Incl GST

ACCESSORIES TO SUIT TOYOTA LANDCRUISER

STEEL WINCH BULL BARS

Commercial Deluxe	BBCD005	\$1985.00
-------------------	---------	-----------

RECOVERY POINTS - IRONMAN 4X4 BULL BAR ONLY

Recovery Points - 5000kg Rating (Pair)	IRP005	\$200.00
--	--------	----------

LOCKSAFE DRAWER SYSTEMS

Twin Drawers - 1000mm	ITD1000	\$1296.00
-----------------------	---------	-----------

Single Drawer - 1000mm	ISD1000	\$783.00
------------------------	---------	----------

Wing Kit - 1000mm (GXL 1998 to 2005)	ITDW018	\$270.00
--------------------------------------	---------	----------

SNORKEL

Landcruiser 105 Series	ISNORKEL003	\$387.00
------------------------	-------------	----------

STEEL ROOF RACKS

Cage Style - 1.8m x 1.25m	IRRCAGE18	\$744.00
---------------------------	-----------	----------

Rooftop Tent Compatible - 1.8m x 1.25m	IRRTENT18	\$709.00
--	-----------	----------

Trade Style - 1.8m x 1.25m (Open end)	IRRTRADE18	\$709.00
---------------------------------------	------------	----------

ALLOY ROOF RACKS

Cage Style - 1.8m x 1.25m	IRRCAGE18-ALLOY	\$1049.00
---------------------------	-----------------	-----------

Trade Style - 1.8m x 1.25m (Open end)	IRRTRADE18-ALLOY	\$1033.00
---------------------------------------	------------------	-----------

Flat Rack - 1.8m x 1.25m	IRRTFLAT18-ALLOY	\$1019.00
--------------------------	------------------	-----------

ROOF RACK - MOUNTING KITS

Landcruiser 100 Mount Feet - 100mm (8 Feet)	IRRFEETLC100	\$180.00
---	--------------	----------

DIFF BREATHER KIT

Diff Breather Kit	IDIFFBRE	\$114.00
-------------------	----------	----------





105 Series
1998+

Toyota Landcruiser

PRODUCT DESCRIPTION

PART NO.

QTY
Required

RETAIL
ea Incl GST

SUSPENSION TO SUIT TOYOTA LANDCRUISER

FRONT SUSPENSION

SHOCK ABSORBER

Nitro Gas - Performance			12683GR	2	\$143.75
Foam Cell - Performance			24683FE	2	\$209.09
Foam Cell - Performance		Suits 4" Lift	24683LFE	2	\$235.23
Foam Cell - Performance		Suits 6" Lift	24683LFE1	2	\$261.36
Foam Cell Pro - Performance			45683FE	2	\$287.50
Foam Cell Pro - Performance		Suits 4" Lift	45683LFE	2	\$300.57
Foam Cell Pro - Performance		Suits 6" Lift	45683LFE1	2	\$313.64

COIL SPRINGS

	Est. Lift	Additional Load			
Medium	50mm	0 - 50kg	TOY024B	1	\$235.23
Medium - 4" Lift	100mm	0 - 100kg	TOY012C	1	\$365.91
Medium - 6" Lift	150mm	0 - 100kg	TOY060B	1	\$431.25
Heavy	50mm	50 - 110kg	TOY024C	1	\$235.23

STEERING DAMPER

Foam Cell			3524	1	\$156.82
-----------	--	--	------	---	----------

CASTER CORRECTION

2° Offset Bush Kit - Polyurethane			1144SK	1	\$143.75
Adjustable Offset STD, 2.5, 3.5° - Polyurethane			1144	1	\$143.75
2° Offset Bush Kit - Rubber			1144RK	1	\$143.75
5° Offset Plate Kit			CPLATE001	1	\$209.09
4° Drop Box			DBOX001	1	\$365.91

STEERING RODS

Adjustable Drag Link	Right Hand Drive		ADL001	1	\$392.04
Adjustable Drag Link	Left Hand Drive		ADL001L	1	\$392.04
Track Rod			ATRO01	1	\$392.04

ADJUSTABLE PANHARD ROD

Right Hand Drive Rod			PANHARD001	1	\$300.57
Left Hand Drive Rod			PANHARD007	1	\$300.57

SWAY BAR LINK

Extended Sway Bar Link			SBEXT001	2	\$26.14
------------------------	--	--	----------	---	---------

COIL SPACER

Polyurethane 20mm			LCF20	2	\$26.14
Polyurethane 30mm			LCF30	2	\$39.21

EXTENDED BRAKE HOSE

Single Hose Models			BHOSE001	1	\$65.34
Dual Hose Models			BHOSE002	2	\$65.34

REAR SUSPENSION

SHOCK ABSORBER

Nitro Gas - Performance			12682GR	2	\$143.75
Foam Cell - Performance			24682FE	2	\$209.09
Foam Cell - Performance		Suits 4" Lift	24682LFE	2	\$235.23
Foam Cell - Performance		Suits 6" Lift	24682LFE1	2	\$261.36
Foam Cell Pro - Performance			45682FE	2	\$287.50
Foam Cell Pro - Performance		Suits 4" Lift	45682LFE	2	\$300.57
Foam Cell Pro - Performance		Suits 6" Lift	45682LFE1	2	\$313.64

COIL SPRINGS

	Est. Lift	Additional Load			
Medium	50mm	0 - 200kg	TOY025B	1	\$235.23
Medium - with Accessories	50mm	100 - 300kg	TOY013B	1	\$235.23
Medium - 4" Lift	100mm	0 - 300kg	TOY013C	1	\$365.91
Medium - 6" Lift	150mm	0 - 300kg	TOY061B	1	\$431.25
Heavy	50mm	200 - 400kg	TOY025C	1	\$248.30
Heavy - 4" Lift	100mm	300 - 500kg	TOY013D	1	\$392.04
Heavy - 6" Lift	150mm	300 - 500kg	TOY061C	1	\$431.25
Extra Heavy	55mm	400 - 500kg	TOY025D	1	\$392.04

LISTING
CONTINUED
OVER THE
PAGE



Toyota Landcruiser

105 Series
1998+



PRODUCT DESCRIPTION

PART NO.

QTY
Required

RETAIL
ea Incl GST

PANHARD ROD

Adjustable Panhard Rod	PANHARD002	1	\$300.57
------------------------	-------------------	---	----------

ADJUSTABLE TRAILING ARM

Upper Trailing Arm	UTA001	2	\$196.02
Lower Trailing Arm	LTA001	2	\$248.30

SWAY BAR LINK

Extended Sway Bar Link	Side mount	SBEXT002	2	\$26.14
Extended Sway Bar Link	Under mount	SBEXT005	2	\$26.14

COIL SPACER

Polyurethane 15mm	LCR15	2	\$26.14
Polyurethane 30mm	LCR30	2	\$39.21

BRAKE HOSE

Extended Brake Hose	BHOSE002	1	\$65.34
---------------------	-----------------	---	---------

BUSH KIT

Rubber Suspension Arm Bush Kit	W/ Standard Radius Arm Bushes	847RK	1	\$378.98
Rubber Suspension Arm Bush Kit	W/ Offset Radius Arm Bushes	847CRK	1	\$378.98

SUSPENSION KIT

Medium - Nitro Gas		TOY024BKG	\$1045.44
Medium - Foam Cell		TOY024BKF	\$1306.80
Medium - Foam Cell	4" Lift RH Drive	TOY012CKF1	\$3541.43
Medium - Foam Cell	4" Lift LH Drive	TOY012CKF1L	\$3541.43
Medium - Foam Cell	6" Lift RH Drive	TOY063BKF1	\$3776.66
Medium - Foam Cell	6" Lift LH Drive	TOY063BKF1L	\$3776.66
Medium - Foam Cell Pro		TOY024BKP	\$1620.44
Medium - Foam Cell Pro	4" Lift RH Drive	TOY012CKP1	\$3802.79
Medium - Foam Cell Pro	4" Lift LH Drive	TOY012CKP1L	\$3802.79
Medium - Foam Cell Pro	6" Lift RH Drive	TOY063BKP1	\$3985.74
Medium - Foam Cell Pro	6" Lift LH Drive	TOY063BKP1L	\$3985.74
Heavy - Nitro Gas		TOY024CKG	\$1058.51
Heavy - Foam Cell		TOY024CKF	\$1319.87
Heavy - Foam Cell	4" Lift RH Drive	TOY012CKF2	\$3541.43
Heavy - Foam Cell	4" Lift LH Drive	TOY012CKF2L	\$3567.57
Heavy - Foam Cell	6" Lift RH Drive	TOY063BKF2	\$3776.66
Heavy - Foam Cell	6" Lift LH Drive	TOY063BKF2L	\$3776.66
Heavy - Foam Cell Pro		TOY024CKP	\$1633.50
Heavy - Foam Cell Pro	4" Lift RH Drive	TOY012CKP2	\$3802.79
Heavy - Foam Cell Pro	4" Lift LH Drive	TOY012CKP2L	\$3828.93
Heavy - Foam Cell Pro	6" Lift RH Drive	TOY063BKP2	\$3985.74
Heavy - Foam Cell Pro	6" Lift LH Drive	TOY063BKP2L	\$3985.74
Extra Heavy - Nitro Gas		TOY024DKG	\$1202.26
Extra Heavy - Foam Cell		TOY024DKF	\$1463.62
Extra Heavy - Foam Cell Pro		TOY024DKP	\$1777.25

- 4" and 6" lifts may not be legal for on-road use in your area, certification may be required for on-road use
- Due to the extreme nature of 4" and 6" lifts, further modifications may be required, and will vary between vehicles, such modifications are entirely the owners responsibility
- Ironman 4x4 accept no responsibility for any damage or injury caused by use of the these products
- Specify front Coil Springs when ordering

50MM SUSPENSION KIT CONTENTS

Shock Absorbers Coil Springs

4" AND 6" SUSPENSION KIT CONTENTS

Shock Absorbers Caster Plates
Coil Springs Brake Hoses
Panhard Rods Adjustable Trailing Arms
Sway Bar Links





100 Series HDJ100, UZJ100, IFS
3/1998 to 10/2007

Toyota Landcruiser

PRODUCT DESCRIPTION

PART NO.

QTY Required

RETAIL ea Incl GST

ACCESSORIES TO SUIT TOYOTA LANDCRUISER

STEEL WINCH BULL BARS

Commercial Deluxe **BBCD006** \$1985.00

RECOVERY POINTS - IRONMAN 4X4 BULL BAR ONLY

Recovery Points - 5000kg Rating (Pair) **IRP005** \$200.00

LOCKSAFE DRAWER SYSTEMS

Twin Drawers - 1000mm **ITD1000** \$1296.00

Single Drawer - 1000mm **ISD1000** \$783.00

Wing Kit - 1000mm (GXL 1998 to 2005) **ITDW018** \$270.00

Wing Kit - 1000mm (2005+) **ITDW019** \$270.00

Wing Kit - 1000mm (DX) **ITDW017** \$270.00

SNORKEL

Landcruiser 100 / Lexus LX 470 **ISNORKEL003** \$387.00

EXHAUST SYSTEM

BigBore Landcruiser 100 Series IFS 1998 to 2007, 4.2L Turbo Diesel - *While Stocks Last* **IEXHAUST010** \$1404.00

STEEL ROOF RACKS

Cage Style - 1.8m x 1.25m **IRRCAGE18** \$744.00

Rooftop Tent Compatible - 1.8m x 1.25m **IRRRTENT18** \$709.00

Trade Style - 1.8m x 1.25m (Open end) **IRRTRADE18** \$709.00

ALLOY ROOF RACKS

Cage Style - 1.8m x 1.25m **IRRCAGE18-ALLOY** \$1049.00

Trade Style - 1.8m x 1.25m (Open end) **IRRTRADE18-ALLOY** \$1033.00

Flat Rack - 1.8m x 1.25m **IRRFLAT18-ALLOY** \$1019.00

ROOF RACK - MOUNTING KITS

Landcruiser 100 Mount Feet - 100mm (8 Feet) **IRRFEETLC100** \$180.00

DIFF BREATHER KIT

Diff Breather Kit **IDIFFBRE** \$114.00

LISTING
CONTINUED
OVER THE
PAGE

Toyota Landcruiser

100 Series, IFS
1998+



PRODUCT DESCRIPTION

PART NO.

QTY
Required

RETAIL
ea Incl GST

SUSPENSION TO SUIT TOYOTA LANDCRUISER

FRONT SUSPENSION

SHOCK ABSORBER

Nitro Gas - Performance			12795GR	2	\$143.75
Foam Cell - Performance			24795FE	2	\$209.09
Foam Cell Pro - Performance			45795FE	2	\$287.50

TORSION BAR

Uprated Torsion Bars	Petrol Models	1160mm Length	TOY050	1	\$470.45
Uprated Torsion Bars	Diesel Models	1210mm Length	TOY051	1	\$470.45

- Must Install BRACKET100
- Some Middle Eastern Petrol models use TOY051 check length before ordering
- Minimum 60mm downward suspension travel required after adjustment

DIFF DROP KIT

Diff Drop Kit			IDD100	1	\$365.91
---------------	--	--	---------------	---	----------

CONTROL ARM

Control Arm Reinforcement			BRACKET100	1	\$39.21
---------------------------	--	--	-------------------	---	---------

REAR SUSPENSION

SHOCK ABSORBER

Nitro Gas - Performance			12796GR	2	\$143.75
Foam Cell - Performance			24796FE	2	\$209.09
Foam Cell Pro - Performance			45796FE	2	\$287.50
Foam Cell Pro - Professional			45796FEP	2	\$287.50

COIL SPRINGS

	Est. Lift	Additional Load			
Medium	25mm	0 - 200kg	TOY013B	1	\$235.23
Heavy	25mm	200 - 400kg	TOY025C	1	\$248.30
Extra Heavy	30mm	400kg - GVM	TOY025D	1	\$392.04

ADJUSTABLE TRAILING ARM

Upper Trailing Arm			UTA003	2	\$196.02
Lower Trailing Arm			LTA003	2	\$248.30

SUSPENSION KIT

Medium - Nitro Gas	Petrol	TOY050BKG	\$1319.87
Medium - Nitro Gas	Diesel	TOY051BKG	\$1319.87
Medium - Foam Cell	Petrol	TOY050BKF	\$1581.23
Medium - Foam Cell	Diesel	TOY051BKF	\$1581.23
Medium - Foam Cell Pro	Petrol	TOY050BKP	\$1894.86
Medium - Foam Cell Pro	Diesel	TOY051BKP	\$1894.86
Heavy - Nitro Gas	Petrol	TOY050CKG	\$1332.94
Heavy - Nitro Gas	Diesel	TOY051CKG	\$1332.94
Heavy - Foam Cell	Petrol	TOY050CKF	\$1594.30
Heavy - Foam Cell	Diesel	TOY051CKF	\$1594.30
Heavy - Foam Cell Pro	Petrol	TOY050CKP	\$1907.93
Heavy - Foam Cell Pro	Diesel	TOY051CKP	\$1907.93
Extra Heavy - Nitro Gas	Petrol	TOY050DKG	\$1476.69
Extra Heavy - Nitro Gas	Diesel	TOY051DKG	\$1476.69
Extra Heavy - Foam Cell	Petrol	TOY050DKF	\$1738.05
Extra Heavy - Foam Cell	Diesel	TOY051DKF	\$1738.05
Extra Heavy - Foam Cell Pro	Petrol	TOY050DKP	\$2051.68
Extra Heavy - Foam Cell Pro	Diesel	TOY051DKP	\$2051.68

- Some Middle Eastern Petrol models use TOY051 check Torsion Bar length before ordering

SUSPENSION KIT CONTENTS

Shock Absorbers	Torsion Bars
Coil Springs	Control Arm Reinforcement





80 Series HZJ80, FZJ80
1990 to 1998

Toyota Landcruiser

PRODUCT DESCRIPTION

PART NO.

QTY Required

RETAIL ea Incl GST

ACCESSORIES TO SUIT TOYOTA LANDCRUISER

STEEL WINCH BULL BARS

Commercial Deluxe BBCD004 \$1985.00

RECOVERY POINTS - IRONMAN 4X4 BULL BAR ONLY

Recovery Points - 5000kg Rating (Pair) IRP005 \$200.00

LOCKSAFE DRAWER SYSTEMS

Twin Drawers - 1000mm ITD1000 \$1296.00

Single Drawer - 1000mm ISD1000 \$783.00

Wing Kit - 1000mm (GXL) ITDW016 \$270.00

Wing Kit - 1000mm (DX) ITDW015 \$270.00

SNORKEL

Landcruiser / Lexus LX 450 ISNORKEL004 \$387.00

STEEL ROOF RACKS

Cage Style - 1.4m x 1.25m IRRCAGE14 \$709.00

Cage Style - 1.8m x 1.25m IRRCAGE18 \$744.00

Cage Style - 2.2m x 1.25m IRRCAGE22 \$772.00

Rooftop Tent Compatible - 1.8m x 1.25m IRRTENT18 \$709.00

Rooftop Tent Compatible - 2.2m x 1.25m IRRTENT22 \$744.00

Trade Style - 1.8m x 1.25m (Open end) IRRTRADE18 \$709.00

Trade Style - 2.2m x 1.25m (Open end) IRRTRADE22 \$738.00

ALLOY ROOF RACKS

Cage Style - 1.4m x 1.25m IRRCAGE14-ALLOY \$897.00

Cage Style - 1.8m x 1.25m IRRCAGE18-ALLOY \$1049.00

Cage Style - 2.2m x 1.25m IRRCAGE22-ALLOY \$1106.00

Trade Style - 1.8m x 1.25m (Open end) IRRTRADE18-ALLOY \$1033.00

Trade Style - 2.2m x 1.25m (Open end) IRRTRADE22-ALLOY \$1078.00

Flat Rack - 1.8m x 1.25m IRRTFLAT18-ALLOY \$1019.00

ROOF RACK - MOUNTING KITS

Gutter Mount Feet - 125mm (8 Feet) IRRFEET125 \$180.00

DIFF BREATHER KIT

Diff Breather Kit IDIFFBRE \$114.00

LISTING
CONTINUED
OVER THE
PAGE

Toyota Landcruiser

80 Series
1990+



PRODUCT DESCRIPTION

PART NO.

QTY
Required

RETAIL
ea Incl GST

SUSPENSION TO SUIT TOYOTA LANDCRUISER

FRONT SUSPENSION

SHOCK ABSORBER

Nitro Gas - Performance			12683GR	2	\$143.75
Foam Cell - Performance			24683FE	2	\$209.09
Foam Cell - Performance		Suits 4" Lift	24683LFE	2	\$235.23
Foam Cell - Performance		Suits 6" Lift	24683LFE1	2	\$261.36
Foam Cell Pro - Performance			45683FE	2	\$287.50
Foam Cell Pro - Performance		Suits 4" Lift	45683LFE	2	\$300.57
Foam Cell Pro - Performance		Suits 6" Lift	45683LFE1	2	\$313.64

COIL SPRINGS

	Est. Lift	Additional Load			
Medium	50mm	0 - 50kg	TOY024B	1	\$235.23
Medium - 4" Lift	100mm	0 - 100kg	TOY012C	1	\$365.91
Medium - 6" Lift	150mm	0 - 100kg	TOY060B	1	\$431.25
Heavy	50mm	50 - 110kg	TOY024C	1	\$235.23

STEERING DAMPER

Foam Cell			3524	1	\$156.82
-----------	--	--	-------------	---	----------

CASTER CORRECTION

2° Offset Bush Kit - Polyurethane			1144SK	1	\$143.75
Adjustable Offset STD, 2.5, 3.5° - Polyurethane			1144	1	\$143.75
2° Offset Bush Kit - Rubber			1144RK	1	\$143.75
5° Offset Plate Kit			CPLATE001	1	\$209.09
4° Drop Box			DBOX001	1	\$365.91

STEERING ROD

Adjustable Drag Link	Right Hand Drive		ADL001	1	\$392.04
Adjustable Drag Link	Left Hand Drive		ADL001L	1	\$392.04
Track Rod			ATR001	1	\$392.04

ADJUSTABLE PANHARD ROD

Right Hand Drive Rod			PANHARD001	1	\$300.57
Left Hand Drive Rod			PANHARD007	1	\$300.57

SWAY BAR LINK

Extended Sway Bar Link			SBEXT001	2	\$26.14
------------------------	--	--	-----------------	---	---------

COIL SPACER

Polyurethane 20mm			LCF20	2	\$26.14
Polyurethane 30mm			LCF30	2	\$39.21

EXTENDED BRAKE HOSE

Single Hose Models			BHOSE001	1	\$65.34
Dual Hose Models			BHOSE002	2	\$65.34

REAR SUSPENSION

SHOCK ABSORBER

Nitro Gas - Performance			12682GR	2	\$143.75
Foam Cell - Performance			24682FE	2	\$209.09
Foam Cell - Performance		Suits 4" Lift	24682LFE	2	\$235.23
Foam Cell - Performance		Suits 6" Lift	24682LFE1	2	\$261.36
Foam Cell Pro - Performance			45682FE	2	\$287.50
Foam Cell Pro - Performance		Suits 4" Lift	45682LFE	2	\$300.57
Foam Cell Pro - Performance		Suits 6" Lift	45682LFE1	2	\$313.64

COIL SPRINGS

	Est. Lift	Additional Load			
Medium	50mm	0 - 200kg	TOY025B	1	\$235.23
Medium - with Accessories	50mm	100 - 300kg	TOY013B	1	\$235.23
Medium - 4" Lift	100mm	0 - 300kg	TOY013C	1	\$365.91
Medium - 6" Lift	150mm	0 - 300kg	TOY061B	1	\$431.25
Heavy	50mm	200 - 400kg	TOY025C	1	\$248.30
Heavy - 4" Lift	100mm	300 - 500kg	TOY013D	1	\$392.04
Heavy - 6" Lift	150mm	300 - 500kg	TOY061C	1	\$431.25
Extra Heavy	55mm	400 - 500kg	TOY025D	1	\$392.04

PANHARD ROD

Adjustable Panhard Rod			PANHARD002	1	\$300.57
------------------------	--	--	-------------------	---	----------

ADJUSTABLE TRAILING ARM

Upper Trailing Arm			UTA001	2	\$196.02
Lower Trailing Arm			LTA001	2	\$248.30





80 Series
1990+

Toyota Landcruiser

PRODUCT DESCRIPTION	PART NO.	QTY Required	RETAIL ea Incl GST
---------------------	----------	-----------------	-----------------------

SWAY BAR LINK

Extended Sway Bar Link	Side Mount	SBEXT002	2	\$26.14
Extended Sway Bar Link	Under Mount	SBEXT005	2	\$26.14

COIL SPACER

Polyurethane 15mm		LCR15	2	\$26.14
Polyurethane 30mm		LCR30	2	\$39.21

BUSH KIT

Rubber Suspension Arm Bush Kit	W/ Standard Radius Arm Bushes	847RK	1	\$378.98
Rubber Suspension Arm Bush Kit	W/ Offset Radius Arm Bushes	847CRK	1	\$378.98

SUSPENSION KIT

Medium - Nitro Gas		TOY024BKG		\$1045.44
Medium - Foam Cell		TOY024BKF		\$1306.80
Medium - Foam Cell	4"Lift	RH Drive	TOY012CKF1	\$3541.43
Medium - Foam Cell	4"Lift	LH Drive	TOY012CKF1L	\$3541.43
Medium - Foam Cell	6"Lift	RH Drive	TOY063BKF1	\$3776.66
Medium - Foam Cell	6"Lift	LH Drive	TOY063BKF1L	\$3776.66
Medium - Foam Cell Pro		TOY024BKP		\$1620.44
Medium - Foam Cell Pro	4"Lift	RH Drive	TOY012CKP1	\$3802.79
Medium - Foam Cell Pro	4"Lift	LH Drive	TOY012CKP1L	\$3802.79
Medium - Foam Cell Pro	6"Lift	RH Drive	TOY063BKP1	\$3985.74
Medium - Foam Cell Pro	6"Lift	LH Drive	TOY063BKP1L	\$3985.74
Heavy - Nitro Gas		TOY024CKG		\$1058.51
Heavy - Foam Cell		TOY024CKF		\$1319.87
Heavy - Foam Cell	4"Lift	RH Drive	TOY012CKF2	\$3541.43
Heavy - Foam Cell	4"Lift	LH Drive	TOY012CKF2L	\$3567.57
Heavy - Foam Cell	6"Lift	RH Drive	TOY063BKF2	\$3776.66
Heavy - Foam Cell	6"Lift	LH Drive	TOY063BKF2L	\$3776.66
Heavy - Foam Cell Pro		TOY024CKP		\$1633.50
Heavy - Foam Cell Pro	4"Lift	RH Drive	TOY012CKP2	\$3802.79
Heavy - Foam Cell Pro	4"Lift	LH Drive	TOY012CKP2L	\$3828.93
Heavy - Foam Cell Pro	6"Lift	RH Drive	TOY063BKP2	\$3985.74
Heavy - Foam Cell Pro	6"Lift	LH Drive	TOY063BKP2L	\$3985.74
Extra Heavy - Nitro Gas		TOY024DKG		\$1202.26
Extra Heavy - Foam Cell		TOY024DKF		\$1463.62
Extra Heavy - Foam Cell Pro		TOY024DKP		\$1777.25

- 4" and 6" lifts may not be legal for on-road use in your area, certification may be required for on-road use
- Due to the extreme nature of 4" and 6" lifts, further modifications may be required, and will vary between vehicles, such modifications are entirely the owners responsibility
- Ironman 4x4 accept no responsibility for any damage or injury caused by use of the these products
- Specify front Coil Springs when ordering

50MM SUSPENSION KIT CONTENTS

Shock Absorbers Coil Springs

4" AND 6" SUSPENSION KIT CONTENTS

Shock Absorbers Caster Plates
 Coil Springs Brake Hoses
 Panhard Rods Adjustable Trailing Arms
 Sway Bar Links





Toyota Landcruiser

PRODUCT DESCRIPTION

PART NO.

QTY Required

RETAIL ea Incl GST

ACCESSORIES TO SUIT TOYOTA LANDCRUISER 79 SERIES SINGLE CAB

STEEL WINCH BULL BARS (NO SIDE PLATES ON BAR)

Commercial - (9/2016+ Only)	BBC019SC	\$1569.00
Commercial - (2007 to 8/2016 Only)	BBC019E	\$1569.00
Commercial - (1999 to 2007 Only)	BBC018	\$1569.00
Commercial Deluxe - (1999 to 2007 Only)	BBCD018	\$1985.00
Protector - (9/2016+ Only)	BBT019SC	\$2009.00
Protector - (2007 to 8/2016 Only) - <i>While Stocks Last</i>	BBT019E	\$2009.00
Premium - 60.3mm Tube - (9/2016+ Only)	BBP019SC	\$2098.00
Premium - 60.3mm Tube - (2007 to 8/2016 Only)	BBP019E	\$2098.00

STEEL SIDE STEPS AND RAILS

Side Steps - (9/2016+ Only)	SS019SC	\$851.00
Side Steps - (2007 to 8/2016 Only)	SS016	\$851.00
Side Rails - (9/2016+ Only)	SS019SC RAIL	\$280.00
Side Steps and Rails - (9/2016+ Only)	SSR019SC	\$1022.00
Side Steps and Rails - (2007 to 8/2016 Only)	SSR016	\$1022.00
Premium Side Steps - 60.3mm Tube - (9/2016+ Only)	SSP019SC	\$933.00
Premium Side Rails - 60.3mm Tube - (9/2016+ Only)	SSP019SC RAIL	\$339.00
Premium Side Steps and Rails - 60.3mm Tube - (9/2016+ Only)	SSRP019SC	\$1129.00
Premium Side Steps and Rails - 60.3mm Tube - (2007 to 8/2016 Only)	SSRP016	\$1129.00

RECOVERY POINTS - IRONMAN 4X4 BULL BAR ONLY

Recovery Points - 5000kg Rating (Pair) - (9/2016+ Only)	IRP019SC	\$216.00
Recovery Points - 5000kg Rating (Pair) - (2007 to 8/2016 Only)	IRP019	\$216.00

SNORKEL

Landcruiser 79 Series V8 - (2007+ Only)	ISNORKELO23	\$387.00
Landcruiser 4.2L 1HZ Diesel - (1999 to 2007 Only)	ISNORKELO09	\$387.00

PREMIUM UNDERBODY PROTECTION

Radiator and Steering Rods - (9/2016+ Only)	UBP019SC	\$276.00
Radiator and Steering Rods - (2007 to 8/2016 Only)	UBP019	\$276.00

SEAT COVER

Canvas Comfort - Front - (9/2016+ Only)	ICSC019SCF	\$400.00
Canvas Comfort - Front Bucket Pair - (2007 to 8/2016 Only)	ICSC019F	\$400.00
Canvas Comfort - Front Bucket and 3/4 Bench - (2007 to 8/2016 Only)	ICSC019F3/4	\$400.00

DIFF BREATHER KIT

Diff Breather Kit	IDIFFBRE	\$114.00
-------------------	----------	----------



79 Series (V8 TD) Single Cab
9/2016+
2007 to 8/2016
1999 to 2007

SUSPENSION TO SUIT

Toyota Landcruiser

PRODUCT DESCRIPTION

PART NO.

QTY
Required

RETAIL
ea Incl GST

SUSPENSION TO SUIT TOYOTA LANDCRUISER 79 SERIES SINGLE CAB

FRONT SUSPENSION

SHOCK ABSORBER

Nitro Gas - Performance			12091GR	2	\$143.75
Foam Cell - Performance			24091FE	2	\$209.09
Foam Cell Pro - Performance			45091FE	2	\$287.50
Foam Cell Pro - Professional			45091FEP	2	\$287.50

COIL SPRINGS

	Est. Lift	Additional Load			
Light	40mm	0 - 50kg	TOY046A	1	\$235.23
Medium	50mm	0 - 50kg	TOY046B	1	\$235.23
Heavy	50mm	50 - 110kg	TOY046C	1	\$235.23
Medium - 4" Lift	100mm	0 - 50kg	TOY079B	1	\$235.23

STEERING DAMPER

Foam Cell	1999-2006	3524	1	\$156.82
Foam Cell	2007+	3525	1	\$156.82

CASTER CORRECTION

2° Offset Bush Kit - Polyurethane		1144SK	1	\$143.75
Adjustable Offset STD, 2.5, 3.5 Degree - Polyurethane		1144	1	\$143.75
2° Offset Bush Kit - Rubber		1144RK	1	\$143.75

STEERING RODS

Adjustable Drag Link	2007+ Wide Body Model Only	ADL070	1	\$392.04
Adjustable Track Rod	2007+ Wide Body Model Only	ATRO70	1	\$392.04

PANHARD ROD

Adjustable Panhard Rod	2007+ RHD Only	PANHARD013	1	\$300.57
Adjustable Panhard Rod	2007+ LHD Only	PANHARD013L	1	\$300.57

SWAY BAR

33mm Sway Bar	Narrow Body 1999-2007	ISB789F	1	\$548.86
33mm Sway Bar	Petrol Engines 2007+	ISB789FWP	1	\$548.86
33mm Sway Bar	Diesel Engines 2007+	ISB789FW	1	\$548.86

SWAY BAR LINK

Extended Sway Bar Link		SBEXT001	2	\$26.14
------------------------	--	-----------------	---	---------

COIL SPACER

Polyurethane 30mm		LC70F30	2	\$39.21
-------------------	--	----------------	---	---------

REAR SUSPENSION

SHOCK ABSORBER

Nitro Gas - Comfort			12094GRC	2	\$143.75
Nitro Gas - Performance			12094GR	2	\$143.75
Foam Cell - Comfort			24094FEC	2	\$209.09
Foam Cell - Performance			24094FE	2	\$209.09
Foam Cell - Professional			24094FEP	2	\$209.09
Foam Cell - Extra Long - Comfort			24094LFEC	2	\$235.23
Foam Cell - Extra Long - Performance			24094LFE	2	\$235.23
Foam Cell - Extra Long - Professional			24094LFEP	2	\$235.23
Foam Cell Pro - Comfort			45094FEC	2	\$287.50
Foam Cell Pro - Performance			45094FE	2	\$287.50
Foam Cell Pro - Professional			45094FEP	2	\$287.50
Foam Cell Pro - Extra Long - Comfort			45094LFEC	2	\$300.57
Foam Cell Pro - Extra Long - Performance			45094LFE	2	\$300.57
Foam Cell Pro - Extra Long - Professional			45094LFEP	2	\$300.57

LEAF SPRINGS

	Est. Lift	Additional Load			
Light	50mm	0 - 150kg	TOY047A	2	\$548.86
Medium	50mm	0 - 250kg	TOY047B	2	\$588.06
Heavy	50mm	250 - 400kg	TOY047C	2	\$614.20
Extra Heavy	50mm	400kg - 600kg	TOY047D	2	\$653.40
Super Heavy	50mm	600kg - GVM	TOY047E	2	\$666.47

**LISTING
CONTINUED
OVER THE
PAGE**





Toyota Landcruiser

PRODUCT DESCRIPTION

PART NO.

QTY
Required

RETAIL
ea Incl GST

U-BOLTS

U-Bolt Kit		416UBK	2	\$39.21
U-Bolt Kit Extra Long	Suit TOY047D and TOY047E Spring	416UBKL	2	\$39.21

POLYURETHANE SPRING BUSHES

Bush Kit		1085UK	1	\$78.41
----------	--	---------------	---	---------

SWAY BAR

30mm Sway Bar (Includes Mounting Brackets)	2007+ Only	ISB789RW	1	\$548.86
--	------------	-----------------	---	----------

GREASABLE SHACKLES AND PINS

Greasable Shackle		1141	2	\$65.34
Greasable Pin		1142	2	\$39.21

HELPER SPRINGS

Load Plus Helper Springs	Drum Brake Models Only	LP9	1	\$222.16
--------------------------	------------------------	------------	---	----------

SUSPENSION KIT

Light - Nitro Gas		TOY046AKG1		\$2064.75
Light - Foam Cell		TOY046AKF1		\$2326.11
Light - Foam Cell Pro		TOY046AKP1		\$2639.74
Medium - Nitro Gas		TOY046BKG1		\$2143.16
Medium - Foam Cell		TOY046BKF1		\$2404.52
Medium - Foam Cell Pro		TOY046BKP1		\$2718.15
Heavy - Nitro Gas		TOY046CKG1		\$2195.43
Heavy - Foam Cell		TOY046CKF1		\$2456.79
Heavy - Foam Cell Pro		TOY046CKP1		\$2770.42
Extra Heavy - Nitro Gas		TOY046DKG1		\$2273.84
Extra Heavy - Foam Cell		TOY046DKF1		\$2587.47
Extra Heavy - Foam Cell Pro		TOY046DKP1		\$2874.96
Super Heavy - Foam Cell		TOY046EKF1		\$2613.60
Super Heavy - Foam Cell Pro		TOY046EKP1		\$2901.10

• Specify front Coil Springs when ordering

SUSPENSION KIT CONTENTS

Shock Absorbers	Leaf Springs	Polyurethane Spring Bushes
Coil Springs	U-Bolts	



OPTIONS AVAILABLE FOR THIS VEHICLE 2007+ ONLY - SEE PAGE 374



79 Series Dual Cab
11/2012+

Toyota Landcruiser

PRODUCT DESCRIPTION

PART NO.

QTY Required

RETAIL ea Incl GST

ACCESSORIES TO SUIT TOYOTA LANDCRUISER

STEEL WINCH BULL BARS (NO SIDE PLATES ON BAR)

Commercial	BBC019E	\$1569.00
Protector - <i>While Stocks Last</i>	BBT019E	\$2009.00
Premium - 60.3mm Tube	BBP019E	\$2098.00

STEEL SIDE STEPS AND RAILS

Side Steps	SS019	\$851.00
Side Steps and Rails	SSR019	\$1022.00
Premium Side Steps and Rails - 60.3mm Tube	SSRP019	\$1129.00

RECOVERY POINTS - IRONMAN 4X4 BULL BAR ONLY

Recovery Points - 5000kg Rating (Pair)	IRP019	\$216.00
--	--------	----------

SNORKEL

Landcruiser 79 Series V8	ISNORKEL023	\$387.00
--------------------------	-------------	----------

EXHAUST SYSTEM

BigBore Landcruiser 70 Series 11/2012 to 8/2016 4.5L V8 Turbo Diesel* - <i>While Stocks Last</i>	IEXHAUST013	\$1360.00
--	-------------	-----------

*Does not suit vehicle with DPf.

STEEL ROOF RACKS

Cage Style - 1.4m x 1.25m	IRRCAGE14	\$709.00
Cage Style - 1.8m x 1.25m	IRRCAGE18	\$744.00
Rooftop Tent Compatible - 1.8m x 1.25m	IRRTENT18	\$709.00
Trade Style - 1.8m x 1.25m (Open end)	IRRTADE18	\$709.00

ALLOY ROOF RACKS

Cage Style - 1.4m x 1.25m	IRRCAGE14-ALLOY	\$897.00
Cage Style - 1.8m x 1.25m	IRRCAGE18-ALLOY	\$1049.00
Trade Style - 1.4m x 1.25m (Open end)	IRROPEN14-ALLOY	\$886.00
Trade Style - 1.8m x 1.25m (Open end)	IRRTADE18-ALLOY	\$1033.00
Flat Rack - 1.8m x 1.25m	IRRTFLAT18-ALLOY	\$1019.00

ROOF RACK - MOUNTING KITS

Gutter Mount Feet - 125mm (8 Feet)	IRRFEE125	\$180.00
------------------------------------	-----------	----------

PREMIUM UNDERBODY PROTECTION

Radiator and Steering Rods	UBP019	\$276.00
----------------------------	--------	----------

EXHAUST SYSTEM

3" Exhaust Upgrade 4.5L V8 - DPF Back (12/2016+) - <i>While Stocks Last</i>	IEX019DPF	\$810.00
---	-----------	----------

SEAT COVER

Canvas Comfort - Front Bucket Pair	ICSC019F	\$400.00
Canvas Comfort - Front Bucket and 3/4 Bench	ICSC019F3/4	\$400.00
Canvas Comfort - Rear	ICSC019R	\$400.00

DIFF BREATHER KIT

Diff Breather Kit	IDIFFBRE	\$114.00
-------------------	----------	----------

LISTING
CONTINUED
OVER THE
PAGE



PRODUCT DESCRIPTION

PART NO.

QTY
RequiredRETAIL
ea Incl GST

SUSPENSION TO SUIT TOYOTA LANDCRUISER

FRONT SUSPENSION

SHOCK ABSORBER

Nitro Gas - Performance			12091GR	2	\$143.75
Foam Cell - Performance			24091FE	2	\$209.09
Foam Cell Pro - Performance			45091FE	2	\$287.50
Foam Cell Pro - Professional			45091FEP	2	\$287.50

COIL SPRINGS

	Est. Lift	Additional Load			
Light	40mm	0 - 50kg	TOY046A	1	\$235.23
Medium	50mm	0 - 50kg	TOY046B	1	\$235.23
Medium - 4" Lift	100mm	0 - 50kg	TOY079B	1	\$235.23
Heavy	50mm	50 - 110kg	TOY046C	1	\$235.23

STEERING DAMPER

Foam Cell			3525	1	\$156.82
-----------	--	--	-------------	---	----------

CASTER CORRECTION

2° Offset Bush Kit - Polyurethane			1144SK	1	\$143.75
Adjustable Offset STD, 2.5, 3.5 Degree - Polyurethane			1144	1	\$143.75
2° Offset Bush Kit - Rubber			1144RK	1	\$143.75

STEERING RODS

Adjustable Drag Link	2007+ Wide Body Model Only		ADL070	1	\$392.04
Adjustable Track Rod	2007+ Wide Body Model Only		ATR070	1	\$392.04

PANHARD ROD

Adjustable Panhard Rod	RHD Only		PANHARD013	1	\$300.57
Adjustable Panhard Rod	2007+ LHD Only		PANHARD013L	1	\$300.57

SWAY BAR

33mm Sway Bar	Petrol Engines		ISB789FWP	1	\$548.86
33mm Sway Bar	Diesel Engines		ISB789FW	1	\$548.86

SWAY BAR LINK

Extended Sway Bar Link			SBEXT001	2	\$26.14
------------------------	--	--	-----------------	---	---------

COIL SPACER

Polyurethane 30mm			LC70F30	2	\$39.21
-------------------	--	--	----------------	---	---------

REAR SUSPENSION

SHOCK ABSORBER

Nitro Gas - Comfort			12094GRC	2	\$143.75
Nitro Gas - Performance			12094GR	2	\$143.75
Foam Cell - Comfort			24094FEC	2	\$209.09
Foam Cell - Performance			24094FE	2	\$209.09
Foam Cell - Professional			24094FEP	2	\$209.09
Foam Cell - Extra Long - Comfort			24094LFEC	2	\$235.23
Foam Cell - Extra Long - Performance			24094LFE	2	\$235.23
Foam Cell - Extra Long - Professional			24094LFEP	2	\$235.23
Foam Cell Pro - Comfort			45094FEC	2	\$287.50
Foam Cell Pro - Performance			45094FE	2	\$287.50
Foam Cell Pro - Professional			45094FEP	2	\$287.50
Foam Cell Pro - Extra Long - Comfort			45094LFEC	2	\$300.57
Foam Cell Pro - Extra Long - Performance			45094LFE	2	\$300.57
Foam Cell Pro - Extra Long - Professional			45094LFEP	2	\$300.57

LEAF SPRINGS

	Est. Lift	Additional Load			
Light	50mm	0 - 250kg	TOY047B	2	\$588.06
Medium	50mm	0 - 300kg	TOY047C	2	\$614.20
Heavy	50mm	300kg - 500kg	TOY047D	2	\$653.40
Extra Heavy	50mm	500kg - GVM	TOY047E	2	\$666.47

U-BOLTS

U-Bolt Kit			416UBK	2	\$39.21
U-Bolt Kit Extra Long	Suit TOY047D and TOY047E Spring		416UBKL	2	\$39.21

POLYURETHANE SPRING BUSHES

Bush Kit			1085UK	1	\$78.41
----------	--	--	---------------	---	---------

SWAY BAR

30mm Sway Bar	Includes Mounting Brackets		ISB789RW	1	\$548.86
---------------	----------------------------	--	-----------------	---	----------

GREASABLE SHACKLES AND PINS

Greasable Shackle			1141	2	\$65.34
Greasable Pin			1142	2	\$39.21

HELPER SPRINGS

Load Plus Helper Springs	Drum Brake Models Only		LP9	1	\$222.16
--------------------------	------------------------	--	------------	---	----------



79 Series Dual Cab
2013+

Toyota Landcruiser

PRODUCT DESCRIPTION

PART NO.

QTY
Required

RETAIL
ea Incl GST

SUSPENSION KIT

Light - Nitro Gas	TOY046BK61	\$2143.16
Light - Foam Cell	TOY046BK61	\$2404.52
Light - Foam Cell Pro	TOY046BK61	\$2718.15
Medium - Nitro Gas	TOY046CK61	\$2195.43
Medium - Foam Cell	TOY046CK61	\$2456.79
Medium - Foam Cell Pro	TOY046CK61	\$2770.42
Heavy - Nitro Gas	TOY046DK61	\$2273.84
Heavy - Foam Cell	TOY046DK61	\$2587.47
Heavy - Foam Cell Pro	TOY046DK61	\$2874.96
Extra Heavy - Foam Cell	TOY046EK61	\$2613.60
Extra Heavy - Foam Cell Pro	TOY046EK61	\$2901.10

• Specify front Coil Springs when ordering

SUSPENSION KIT CONTENTS

Shock Absorbers	Leaf Springs	Polyurethane Spring Bushes
Coil Springs	U-Bolts	



OPTIONS AVAILABLE FOR THIS VEHICLE 2012+ ONLY - SEE PAGE 375



You have entered Cruiser country!



for a full range of accessories visit our website

www.ironman4x4.com



78 Series Troop Carrier
2007+

Toyota Landcruiser

PRODUCT DESCRIPTION

PART NO.

QTY
RequiredRETAIL
ea Incl GST

ACCESSORIES TO SUIT TOYOTA LANDCRUISER

STEEL WINCH BULL BARS (NO SIDE PLATES ON BAR)

Commercial	BBC019E	\$1569.00
Protector - <i>While Stocks Last</i>	BBT019E	\$2009.00
Premium - 60.3mm Tube	BBP019E	\$2098.00

LOCKSAFE DRAWER SYSTEMS

Twin Drawers - 1300mm	ITD1300	\$1469.00
Single Drawer - 1300mm	ISD1300	\$891.00
Wing Kit - 1300mm (GXL 2008+)	ITDW022	\$351.00

RECOVERY POINTS - IRONMAN 4X4 BULL BAR ONLY

Recovery Points - 5000kg Rating (Pair)	IRP019	\$216.00
--	--------	----------

SNORKEL

Landcruiser 78 Series V8 2007+	ISNORKEL023	\$387.00
--------------------------------	-------------	----------

EXHAUST SYSTEM

BigBore Landcruiser 78 Series 2007 to 8/2016 4.5L V8 Turbo Diesel* - <i>While Stocks Last</i>	IEXHAUST009	\$1360.00
---	-------------	-----------

*Does not suit vehicle with DPF

STEEL ROOF RACKS

Cage Style - 1.4m x 1.25m	IRRCAGE14	\$709.00
Cage Style - 1.8m x 1.25m	IRRCAGE18	\$744.00
Cage Style - 2.2m x 1.25m	IRRCAGE22	\$772.00
Rooftop Tent Compatible - 1.8m x 1.25m	IRRTENT18	\$709.00
Rooftop Tent Compatible - 2.2m x 1.25m	IRRTENT22	\$744.00
Trade Style - 1.8m x 1.25m (Open end)	IRRTRADE18	\$709.00
Trade Style - 2.2m x 1.25m (Open end)	IRRTRADE22	\$738.00

ALLOY ROOF RACKS

Cage Style - 1.4m x 1.25m	IRRCAGE14-ALLOY	\$897.00
Cage Style - 1.8m x 1.25m	IRRCAGE18-ALLOY	\$1049.00
Cage Style - 2.2m x 1.25m	IRRCAGE22-ALLOY	\$1106.00
Trade Style - 1.4m x 1.25m (Open end)	IRROPEN14-ALLOY	\$886.00
Trade Style - 1.8m x 1.25m (Open end)	IRRTRADE18-ALLOY	\$1033.00
Trade Style - 2.2m x 1.25m (Open end)	IRRTRADE22-ALLOY	\$1078.00
Flat Rack - 1.8m x 1.25m	IRRTFLAT18-ALLOY	\$1019.00

ROOF RACK - MOUNTING KITS

Gutter Mount Feet - 210mm (8 Feet)	IRRFEE210	\$199.00
------------------------------------	-----------	----------

PREMIUM UNDERBODY PROTECTION

Radiator and Steering Rods	UBP019	\$276.00
----------------------------	--------	----------

SEAT COVER

Canvas Comfort - Front Bucket Pair	ICSC019F	\$400.00
Canvas Comfort - Front Bucket and 3/4 Bench	ICSC019F3/4	\$400.00

DIFF BREATHER KIT

Diff Breather Kit	IDIFFBRE	\$114.00
-------------------	----------	----------

LISTING
CONTINUED
OVER THE
PAGE



PRODUCT DESCRIPTION

PART NO.

QTY
RequiredRETAIL
ea Incl GST

SUSPENSION TO SUIT TOYOTA LANDCRUISER

FRONT SUSPENSION

SHOCK ABSORBER

Nitro Gas - Performance			12091GR	2	\$143.75
Foam Cell - Performance			24091FE	2	\$209.09
Foam Cell Pro - Performance			45091FE	2	\$287.50
Foam Cell Pro - Professional			45091FEP	2	\$287.50

COIL SPRINGS

	Est. Lift	Additional Load			
Light	40mm	0 - 50kg	TOY046A	1	\$235.23
Medium	50mm	0 - 50kg	TOY046B	1	\$235.23
Medium - 4" Lift	100mm	0 - 50kg	TOY079B	1	\$235.23
Heavy	50mm	50 - 110kg	TOY046C	1	\$235.23

CASTER CORRECTION

2° Offset Bush Kit - Polyurethane			1144SK	1	\$143.75
Adjustable Offset STD, 2.5, 3.5 Degree - Polyurethane			1144	1	\$143.75
2° Offset Bush Kit - Rubber			1144RK	1	\$143.75

STEERING RODS

Adjustable Drag Link	2007+ Wide Body Model Only		ADL070	1	\$392.04
Adjustable Track Rod	2007+ Wide Body Model Only		ATR070	1	\$392.04

PANHARD ROD

Adjustable Panhard Rod	2007+ RHD Only		PANHARD013	1	\$300.57
Adjustable Panhard Rod	2007+ LHD Only		PANHARD013L	1	\$300.57

SWAY BAR

33mm Sway Bar	Narrow Body 1999-2007		ISB789F	1	\$548.86
33mm Sway Bar	Petrol Engines 2007+		ISB789FWP	1	\$548.86
33mm Sway Bar	Diesel Engines 2007+		ISB789FW	1	\$548.86

SWAY BAR LINK

Extended Sway Bar Link			SBEXT001	2	\$26.14
------------------------	--	--	-----------------	---	---------

COIL SPACER

Polyurethane 30mm			LC70F30	2	\$39.21
-------------------	--	--	----------------	---	---------

REAR SUSPENSION

SHOCK ABSORBER

Nitro Gas - Comfort			12094GRC	2	\$143.75
Nitro Gas - Performance			12094GR	2	\$143.75
Foam Cell - Comfort			24094FEC	2	\$209.09
Foam Cell - Performance			24094FE	2	\$209.09
Foam Cell - Professional			24094FEP	2	\$209.09
Foam Cell - Extra Long - Comfort			24094LFEC	2	\$235.23
Foam Cell - Extra Long - Performance			24094LFE	2	\$235.23
Foam Cell - Extra Long - Professional			24094LFEP	2	\$235.23
Foam Cell Pro - Comfort			45094FEC	2	\$287.50
Foam Cell Pro - Performance			45094FE	2	\$287.50
Foam Cell Pro - Professional			45094FEP	2	\$287.50
Foam Cell Pro - Extra Long - Comfort			45094LFEC	2	\$300.57
Foam Cell Pro - Extra Long - Performance			45094LFE	2	\$300.57
Foam Cell Pro - Extra Long - Professional			45094LFEP	2	\$300.57

LEAF SPRINGS

	Est. Lift	Additional Load			
Light	50mm	0 - 150kg	TOY047A	2	\$548.86
Medium	50mm	0 - 250kg	TOY047B	2	\$588.06
Heavy	50mm	250 - 400kg	TOY047C	2	\$614.20
Extra Heavy	50mm	400kg - 600kg	TOY047D	2	\$653.40
Super Heavy	50mm	600kg - GVM	TOY047E	2	\$666.47

U-BOLTS

U-Bolt Kit			416UBK	2	\$39.21
U-Bolt Kit Extra Long	Suit TOY047D and TOY047E Spring		416UBKL	2	\$39.21

POLYURETHANE SPRING BUSHES

Bush Kit			1084UK	1	\$78.41
----------	--	--	---------------	---	---------

SWAY BAR

30mm Sway Bar (Includes Mounting Brackets)	2007+ Only		ISB789RW	1	\$548.86
--	------------	--	-----------------	---	----------

GREASABLE SHACKLES AND PINS

Greasable Shackle			1141	2	\$65.34
Greasable Pin			1142	2	\$39.21

HELPER SPRINGS

Load Plus Helper Springs	Drum Brake Models Only		LP9	1	\$222.16
--------------------------	------------------------	--	------------	---	----------



78 Series
2007+

Toyota Landcruiser

PRODUCT DESCRIPTION

PART NO.

QTY
Required

RETAIL
ea Incl GST

SUSPENSION KIT

Light - Nitro Gas	TOY046AKG	\$2064.75
Light - Foam Cell	TOY046AKF	\$2326.11
Light - Foam Cell Pro	TOY046AKP	\$2639.74
Medium - Nitro Gas	TOY046BKG	\$2143.16
Medium - Foam Cell	TOY046BKF	\$2404.52
Medium - Foam Cell Pro	TOY046BKP	\$2718.15
Heavy - Nitro Gas	TOY046CKG	\$2195.43
Heavy - Foam Cell	TOY046CKF	\$2456.79
Heavy - Foam Cell Pro	TOY046CKP	\$2770.42
Extra Heavy - Nitro Gas	TOY046DKG	\$2273.84
Extra Heavy - Foam Cell	TOY046DKF	\$2587.47
Extra Heavy - Foam Cell Pro	TOY046DKP	\$2874.96
Super Heavy - Foam Cell	TOY046EKF	\$2613.60
Super Heavy - Foam Cell Pro	TOY046EKP	\$2901.10

• Specify front Coil Springs when ordering

SUSPENSION KIT CONTENTS

Shock Absorbers	Leaf Springs	Polyurethane Spring Bushes
Coil Springs	U-Bolts	



OPTIONS AVAILABLE FOR THIS VEHICLE 2007+ ONLY - SEE PAGE 376

Alu-Cab™

ULTIMATE OVERLAND PRODUCTS

HERCULES 

Roof conversion
to Suit Landcruiser Troopy



for a full range of alu-cab visit our website

www.alu-cab.com.au

distributed by





78 Series
1999 to 2007

ACCESSORIES TO SUIT

Toyota Landcruiser

PRODUCT DESCRIPTION

PART NO.

QTY
Required

RETAIL
ea Incl GST

ACCESSORIES TO SUIT TOYOTA LANDCRUISER

STEEL WINCH BULL BARS (NO SIDE PLATES ON BAR)

Commercial	BBC018	\$1569.00
Commercial Deluxe	BBCD018	\$1985.00

LOCKSAFE DRAWER SYSTEMS

Twin Drawers - 1300mm Troop Carrier LC78	ITD1300	\$1469.00
Single Drawer - 1300mm	ISD1300	\$891.00

SNORKEL

Landcruiser 4.2L 1HZ Diesel	ISNORKEL009	\$387.00
-----------------------------	-------------	----------

STEEL ROOF RACKS

Cage Style - 1.4m x 1.25m	IRRCAGE14	\$709.00
Cage Style - 1.8m x 1.25m	IRRCAGE18	\$744.00
Cage Style - 2.2m x 1.25m	IRRCAGE22	\$772.00
Rooftop Tent Compatible - 1.8m x 1.25m	IRRTENT18	\$709.00
Rooftop Tent Compatible - 2.2m x 1.25m	IRRTENT22	\$744.00
Trade Style - 1.8m x 1.25m (Open end)	IRRTADE18	\$709.00
Trade Style - 2.2m x 1.25m (Open end)	IRRTADE22	\$738.00

ALLOY ROOF RACKS

Cage Style - 1.4m x 1.25m	IRRCAGE14-ALLOY	\$897.00
Cage Style - 1.8m x 1.25m	IRRCAGE18-ALLOY	\$1049.00
Cage Style - 2.2m x 1.25m	IRRCAGE22-ALLOY	\$1106.00
Trade Style - 1.4m x 1.25m (Open end)	IRROPEN14-ALLOY	\$886.00
Trade Style - 1.8m x 1.25m (Open end)	IRRTADE18-ALLOY	\$1033.00
Trade Style - 2.2m x 1.25m (Open end)	IRRTADE22-ALLOY	\$1078.00
Flat Rack - 1.8m x 1.25m	IRRTFLAT18-ALLOY	\$1019.00

ROOF RACK - MOUNTING KITS

Gutter Mount Feet - 210mm (8 Feet)	IRRFEET210	\$199.00
------------------------------------	------------	----------

DIFF BREATHER KIT

Diff Breather Kit	IDIFFBRE	\$114.00
-------------------	----------	----------

LISTING
CONTINUED
OVER THE
PAGE



PRODUCT DESCRIPTION

PART NO.

QTY
RequiredRETAIL
ea Incl GST

SUSPENSION TO SUIT TOYOTA LANDCRUISER

FRONT SUSPENSION

SHOCK ABSORBER

Nitro Gas - Performance			12091GR	2	\$143.75
Foam Cell - Performance			24091FE	2	\$209.09
Foam Cell Pro - Performance			45091FE	2	\$287.50
Foam Cell Pro - Professional			45091FEP	2	\$287.50

COIL SPRINGS

	Est. Lift	Additional Load			
Light	40mm	0 - 50kg	TOY046A	1	\$235.23
Medium	50mm	0 - 50kg	TOY046B	1	\$235.23
Medium - 4" Lift	100mm	0 - 50kg	TOY079B	1	\$235.23
Heavy	50mm	50 - 110kg	TOY046C	1	\$235.23

STEERING DAMPER

Foam Cell	1999-2006	3524	1	\$156.82
Foam Cell	2007+	3525	1	\$156.82

CASTER CORRECTION

2° Offset Bush Kit - Polyurethane	1144SK	1	\$143.75
Adjustable Offset STD, 2.5, 3.5 Degree - Polyurethane	1144	1	\$143.75
2° Offset Bush Kit - Rubber	1144RK	1	\$143.75

PANHARD ROD

Adjustable Panhard Rod	2007+ RHD Only	PANHARD013	1	\$300.57
Adjustable Panhard Rod	2007+ LHD Only	PANHARD013L	1	\$300.57

SWAY BAR

33mm Sway Bar	Narrow Body 1999-2007	ISB789F	1	\$548.86
33mm Sway Bar	Petrol Engines 2007+	ISB789FWP	1	\$548.86
33mm Sway Bar	Diesel Engines 2007+	ISB789FW	1	\$548.86

SWAY BAR LINK

Extended Sway Bar Link	SBEXT001	2	\$26.14
------------------------	-----------------	---	---------

COIL SPACER

Polyurethane 30mm	LC70F30	2	\$39.21
-------------------	----------------	---	---------

REAR SUSPENSION

SHOCK ABSORBER

Nitro Gas - Comfort	12094GRC	2	\$143.75
Nitro Gas - Performance	12094GR	2	\$143.75
Foam Cell - Comfort	24094FEC	2	\$209.09
Foam Cell - Performance	24094FE	2	\$209.09
Foam Cell - Professional	24094FEP	2	\$209.09
Foam Cell - Extra Long - Comfort	24094LFEC	2	\$235.23
Foam Cell - Extra Long - Performance	24094LFE	2	\$235.23
Foam Cell - Extra Long - Professional	24094LFEP	2	\$235.23
Foam Cell Pro - Comfort	45094FEC	2	\$287.50
Foam Cell Pro - Performance	45094FE	2	\$287.50
Foam Cell Pro - Professional	45094FEP	2	\$287.50
Foam Cell Pro - Extra Long - Comfort	45094LFEC	2	\$300.57
Foam Cell Pro - Extra Long - Performance	45094LFE	2	\$300.57
Foam Cell Pro - Extra Long - Professional	45094LFEP	2	\$300.57

LEAF SPRINGS

	Est. Lift	Additional Load			
Light	50mm	0 - 150kg	TOY047A	2	\$548.86
Medium	50mm	0 - 250kg	TOY047B	2	\$588.06
Heavy	50mm	250 - 400kg	TOY047C	2	\$614.20
Extra Heavy	50mm	400kg - 600kg	TOY047D	2	\$653.40
Super Heavy	50mm	600kg - GVM	TOY047E	2	\$666.47

U-BOLTS

U-Bolt Kit	416UBK	2	\$39.21
U-Bolt Kit Extra Long	Suit TOY047D and TOY047E Spring 416UBKL	2	\$39.21

POLYURETHANE SPRING BUSHES

Bush Kit	1084UK	1	\$78.41
----------	---------------	---	---------

SWAY BAR

30mm Sway Bar (Includes Mounting Brackets)	2007+ Only	ISB789RW	1	\$548.86
--	------------	-----------------	---	----------

GREASABLE SHACKLES AND PINS

Greasable Shackle	1141	2	\$65.34
Greasable Pin	1142	2	\$39.21

HELPER SPRINGS

Load Plus Helper Springs	Drum Brake Models Only	LP9	1	\$222.16
--------------------------	------------------------	------------	---	----------



78 Series
1999 to 2007

SUSPENSION TO SUIT

Toyota Landcruiser

PRODUCT DESCRIPTION

PART NO.

QTY Required

RETAIL ea Incl GST

SUSPENSION KIT

Light - Nitro Gas	TOY046AKG	\$2064.75
Light - Foam Cell	TOY046AKF	\$2326.11
Light - Foam Cell Pro	TOY046AKP	\$2639.74
Medium - Nitro Gas	TOY046BKG	\$2143.16
Medium - Foam Cell	TOY046BKF	\$2404.52
Medium - Foam Cell Pro	TOY046BKP	\$2718.15
Heavy - Nitro Gas	TOY046CKG	\$2195.43
Heavy - Foam Cell	TOY046CKF	\$2456.79
Heavy - Foam Cell Pro	TOY046CKP	\$2770.42
Extra Heavy - Nitro Gas	TOY046DKG	\$2273.84
Extra Heavy - Foam Cell	TOY046DKF	\$2587.47
Extra Heavy - Foam Cell Pro	TOY046DKP	\$2874.96
Super Heavy - Foam Cell	TOY046EKF	\$2613.60
Super Heavy - Foam Cell Pro	TOY046EKP	\$2901.10

• Specify front Coil Springs when ordering

SUSPENSION KIT CONTENTS

Shock Absorbers	Leaf Springs	Polyurethane Spring Bushes
Coil Springs	U-Bolts	



sometimes the best things in life come in fun size



for a full range of accessories visit our website

www.ironman4x4.com



76 Series
2007+

Toyota Landcruiser

PRODUCT DESCRIPTION

PART NO.

QTY
RequiredRETAIL
ea Incl GST

ACCESSORIES TO SUIT TOYOTA LANDCRUISER

STEEL WINCH BULL BARS (NO SIDE PLATES ON BAR)

Commercial	BBC019E	\$1569.00
Protector - <i>While Stocks Last</i>	BBT019E	\$2009.00
Premium - 60.3mm Tube	BBP019E	\$2098.00

STEEL SIDE STEPS AND RAILS

Side Steps	SS015	\$851.00
Side Steps and Rails	SSR015	\$1022.00
Premium Side Steps and Rails - 60.3mm Tube	SSRP015	\$1129.00

LOCKSAFE DRAWER SYSTEMS

Twin Drawers - 900mm	ITD900	\$1242.00
Single Drawer - 900mm	ISD900	\$767.00
Wing Kit - 900mm (76 Series GXL)	ITDW009	\$270.00

RECOVERY POINTS - IRONMAN 4X4 BULL BAR ONLY

Recovery Points - 5000kg Rating (Pair)	IRP019	\$216.00
--	--------	----------

SNORKEL

Landcruiser V8 2007+	ISNORKEL023	\$387.00
----------------------	-------------	----------

EXHAUST SYSTEM

BigBore Landcruiser 76 Series 2007 to 8/2016, 4.5L V8 Turbo Diesel* - <i>While Stocks Last</i>	IEXHAUST002	\$1360.00
--	-------------	-----------

*Does not suit vehicle with DPF

STEEL ROOF RACKS

Cage Style - 1.4m x 1.25m	IRRCAGE14	\$709.00
Cage Style - 1.8m x 1.25m	IRRCAGE18	\$744.00
Cage Style - 2.2m x 1.25m	IRRCAGE22	\$772.00
Rooftop Tent Compatible - 1.8m x 1.25m	IRRTENT18	\$709.00
Rooftop Tent Compatible - 2.2m x 1.25m	IRRTENT22	\$744.00
Trade Style - 1.8m x 1.25m (Open end)	IRRTADE18	\$709.00
Trade Style - 2.2m x 1.25m (Open end)	IRRTADE22	\$738.00

ALLOY ROOF RACKS

Cage Style - 1.4m x 1.25m	IRRCAGE14-ALLOY	\$897.00
Cage Style - 1.8m x 1.25m	IRRCAGE18-ALLOY	\$1049.00
Cage Style - 2.2m x 1.25m	IRRCAGE22-ALLOY	\$1106.00
Trade Style - 1.8m x 1.25m (Open end)	IRRTADE18-ALLOY	\$1033.00
Trade Style - 2.2m x 1.25m (Open end)	IRRTADE22-ALLOY	\$1078.00
Flat Rack - 1.8m x 1.25m	IRRTFLAT18-ALLOY	\$1019.00

ROOF RACK - MOUNTING KITS

Gutter Mount Feet - 125mm (8 Feet)	IRRFEE125	\$180.00
------------------------------------	-----------	----------

PREMIUM UNDERBODY PROTECTION

Radiator and Steering Rods	UBP019	\$276.00
----------------------------	--------	----------

LONG RANGE FUEL TANK

160L* Diesel - 76 Series up to 11/2012 only	TANK001	\$1129.00
---	---------	-----------

* Usable volume may differ to the stated tank capacity

SEAT COVER

Canvas Comfort - Front Bucket Pair	ICSC019F	\$400.00
Canvas Comfort - Rear	ICSC019R	\$400.00

DIFF BREATHER KIT

Diff Breather Kit	IDIFFBRE	\$114.00
-------------------	----------	----------

LISTING
CONTINUED
OVER THE
PAGE



PRODUCT DESCRIPTION

PART NO.

QTY
RequiredRETAIL
ea Incl GST

SUSPENSION TO SUIT TOYOTA LANDCRUISER

FRONT SUSPENSION

SHOCK ABSORBER

Nitro Gas - Performance			12091GR	2	\$143.75
Foam Cell - Performance			24091FE	2	\$209.09
Foam Cell Pro - Performance			45091FE	2	\$287.50
Foam Cell Pro - Professional			45091FEP	2	\$287.50

COIL SPRINGS

	Est. Lift	Additional Load			
Light	40mm	0 - 50kg	TOY046A	1	\$235.23
Medium	50mm	0 - 50kg	TOY046B	1	\$235.23
Medium - 4" Lift	100mm	0 - 50kg	TOY079B	1	\$235.23
Heavy	50mm	50 - 110kg	TOY046C	1	\$235.23

STEERING DAMPER

Foam Cell			3525	1	\$156.82
-----------	--	--	-------------	---	----------

CASTER CORRECTION

2° Offset Bush Kit - Polyurethane			1144SK	1	\$143.75
Adjustable Offset STD, 2.5, 3.5 Degree - Polyurethane			1144	1	\$143.75
2° Offset Bush Kit - Rubber			1144RK	1	\$143.75

PANHARD ROD

Adjustable Panhard Rod	RHD Only		PANHARD013	1	\$300.57
Adjustable Panhard Rod	2007+ LHD Only		PANHARD013L	1	\$300.57

SWAY BAR

33mm Sway Bar	Petrol Engines		ISB789FWP	1	\$548.86
33mm Sway Bar	Diesel Engines		ISB789FW	1	\$548.86

SWAY BAR LINK

Extended Sway Bar Link			SBEXT001	2	\$26.14
------------------------	--	--	-----------------	---	---------

COIL SPACER

Polyurethane 30mm			LC70F30	2	\$39.21
-------------------	--	--	----------------	---	---------

REAR SUSPENSION

SHOCK ABSORBER

Nitro Gas - Comfort			12094GRC	2	\$143.75
Nitro Gas - Performance			12094GR	2	\$143.75
Foam Cell - Comfort			24094FEC	2	\$209.09
Foam Cell - Performance			24094FE	2	\$209.09
Foam Cell - Professional			24094FEP	2	\$209.09
Foam Cell - Extra Long - Comfort			24094LFEC	2	\$235.23
Foam Cell - Extra Long - Performance			24094LFE	2	\$235.23
Foam Cell - Extra Long - Professional			24094LFEP	2	\$235.23
Foam Cell Pro - Comfort			45094FEC	2	\$287.50
Foam Cell Pro - Performance			45094FE	2	\$287.50
Foam Cell Pro - Professional			45094FEP	2	\$287.50
Foam Cell Pro - Extra Long - Comfort			45094LFEC	2	\$300.57
Foam Cell Pro - Extra Long - Performance			45094LFE	2	\$300.57
Foam Cell Pro - Extra Long - Professional			45094LFEP	2	\$300.57

LEAF SPRINGS

	Est. Lift	Additional Load			
Medium	50mm	0 - 300kg	TOY062B	2	\$548.86
Heavy	50mm	300 - 600kg	TOY062C	2	\$575.00
Extra Heavy	50mm	600kg - GVM	TOY062D	2	\$588.06

U-BOLTS

U-Bolt Kit			416UBK	2	\$39.21
------------	--	--	---------------	---	---------

POLYURETHANE SPRING BUSHES

Bush Kit			1085UK	1	\$78.41
----------	--	--	---------------	---	---------

GREASABLE SHACKLES AND PINS

Greasable Shackle			1141-1	2	\$65.34
Greasable Shackle Extended 20mm			1141	2	\$65.34
Greasable Pin			1142	2	\$39.21

SWAY BAR

30mm Sway Bar	Includes Mounting Brackets		ISB789RW	1	\$548.86
---------------	----------------------------	--	-----------------	---	----------

HELPER SPRINGS

Load Plus Helper Springs			LP4	1	\$156.82
--------------------------	--	--	------------	---	----------



76 Series
2007+

Toyota Landcruiser

PRODUCT DESCRIPTION

PART NO.

QTY
Required

RETAIL
ea Incl GST

SUSPENSION KIT

Medium - Nitro Gas	TOY062BKG	\$2064.75
Medium - Foam Cell	TOY062BKF	\$2326.11
Medium - Foam Cell Pro	TOY062BKP	\$2639.74
Heavy - Nitro Gas	TOY062CKG	\$2117.02
Heavy - Foam Cell	TOY062CKF	\$2378.38
Heavy - Foam Cell Pro	TOY062CKP	\$2953.37
Extra Heavy - Nitro Gas	TOY062DKG	\$2143.16
Extra Heavy - Foam Cell	TOY062DKF	\$2404.52
Extra Heavy - Foam Cell Pro	TOY062DKP	\$2979.51

• Specify front Coil Springs when ordering

SUSPENSION KIT CONTENTS

Shock Absorbers	Coil Springs	Polyurethane Spring Bushes
Leaf Springs	U-Bolts	



Toyota Landcruiser

75 Series
1984 to 1999



PRODUCT DESCRIPTION

PART NO.

QTY
Required

RETAIL
ea Incl GST

ACCESSORIES TO SUIT TOYOTA LANDCRUISER

STEEL WINCH BULL BARS (NO SIDE PLATES ON BAR)

Commercial	BBC018	\$1569.00
Commercial Deluxe	BBCD018	\$1985.00

LOCKSAFE DRAWER SYSTEMS

Twin Drawers - 1300mm	ITD1300	\$1469.00
Single Drawer - 1300mm	ISD1300	\$891.00

SNORKEL

Landcruiser 4.2L 1HZ Diesel	ISNORKEL009	\$387.00
-----------------------------	-------------	----------

DIFF BREATHER KIT

Diff Breather Kit	IDIFFBRE	\$114.00
-------------------	----------	----------





75 Series
1984 to 1999

Toyota Landcruiser

PRODUCT DESCRIPTION

PART NO.

QTY Required

RETAIL ea Incl GST

SUSPENSION TO SUIT TOYOTA LANDCRUISER

FRONT SUSPENSION

SHOCK ABSORBER

Nitro Gas - Comfort			12637GRC	2	\$143.75
Nitro Gas - Performance			12637GR	2	\$143.75
Foam Cell - Comfort			24637FEC	2	\$209.09
Foam Cell - Performance			24637FE	2	\$209.09
Foam Cell Pro - Comfort			45637FEC	2	\$287.50
Foam Cell Pro - Performance			45637FE	2	\$287.50

LEAF SPRINGS

	Est. Lift	Additional Load			
Medium	50mm	0 - 50kg	TOY008B	2	\$352.84
Heavy	50mm	50 - 100kg	TOY008C	2	\$378.98

STEERING DAMPER

Foam Cell			3524	1	\$156.82
-----------	--	--	------	---	----------

U-BOLTS

U-Bolt Kit			436UBK	2	\$39.21
------------	--	--	--------	---	---------

POLYURETHANE SPRING BUSHES

Bush Kit			719UK	1	\$65.34
----------	--	--	-------	---	---------

GREASABLE SHACKLES AND PINS

Greasable Shackle	Left Hand Side		348LH	1	\$65.34
Greasable Shackle	Right Hand Side		348RH	1	\$65.34
Greasable Pin			351	2	\$39.21

REAR SUSPENSION

SHOCK ABSORBER

Nitro Gas - Comfort			12081GRC	2	\$143.75
Nitro Gas - Performance			12081GR	2	\$143.75
Foam Cell - Comfort			24081FEC	2	\$209.09
Foam Cell - Performance			24081FE	2	\$209.09
Foam Cell - Professional			24081FEP	2	\$209.09
Foam Cell Pro - Comfort			45081FEC	2	\$287.50
Foam Cell Pro - Performance			45081FE	2	\$287.50
Foam Cell Pro - Professional			45081FEP	2	\$287.50

LEAF SPRINGS

	Est. Lift	Additional Load			
Medium	50mm	0 - 200kg	TOY009B	2	\$496.59
Heavy	50mm	200 - 400kg	TOY009C	2	\$509.66
Extra Heavy	50mm	400 - 600kg	TOY009D	2	\$522.72
Super Heavy	50mm	600kg - GVM	TOY009E	2	\$548.86

U-BOLTS

U-Bolt Kit			416UBK	2	\$39.21
------------	--	--	--------	---	---------

POLYURETHANE SPRING BUSHES

Bush Kit			720UK	1	\$65.34
----------	--	--	-------	---	---------

GREASABLE SHACKLES AND PINS

Greasable Shackle	Left Hand Side		353LH	1	\$65.34
Greasable Shackle	Right Hand Side		353RH	1	\$65.34
Greasable Pin			354	2	\$39.21

HELPER SPRINGS

Load Plus Helper Springs	Drum Brake Models Only		LP4	1	\$156.82
--------------------------	------------------------	--	-----	---	----------

SUSPENSION KIT

Medium - Nitro Gas			TOY008BKG		\$2561.33
Medium - Foam Cell			TOY008BKF		\$2822.69
Medium - Foam Cell Pro			TOY008BKP		\$3136.32
Heavy - Nitro Gas			TOY008CKG		\$2587.47
Heavy - Foam Cell			TOY008CKF		\$2848.83
Heavy - Foam Cell Pro			TOY008CKP		\$3162.46
Extra Heavy - Nitro Gas			TOY009DKG		\$2613.60
Extra Heavy - Foam Cell			TOY009DKF		\$2874.96
Extra Heavy - Foam Cell Pro			TOY009DKP		\$3188.60
Super Heavy - Nitro Gas			TOY009EKG		\$2665.88
Super Heavy - Foam Cell			TOY009EKF		\$2927.24
Super Heavy - Foam Cell Pro			TOY009EKP		\$3240.87

• Specify front Coil Springs when ordering

SUSPENSION KIT CONTENTS

Shock Absorbers

Leaf Springs

U-Bolts

Polyurethane Spring Bushes



Toyota Landcruiser II

Prado 70, 73, 78 Series
1990 to 1996



PRODUCT DESCRIPTION

PART NO.

QTY
Required

RETAIL
ea Incl GST

SUSPENSION TO SUIT TOYOTA LANDCRUISER II

FRONT SUSPENSION

SHOCK ABSORBER

Nitro Gas - Performance			12696GR	2	\$143.75
Foam Cell - Performance			24696FE	2	\$209.09

COIL SPRINGS

	Est. Lift	Additional Load			
Medium	50mm	0 - 50kg	TOY048B	1	\$235.23
Heavy	50mm	50 - 100kg	TOY048C	1	\$217.80

STEERING DAMPER

Foam Cell			3524	1	\$156.82
-----------	--	--	-------------	---	----------

REAR SUSPENSION

SHOCK ABSORBER

Nitro Gas - Performance			12697GR	2	\$143.75
Foam Cell - Performance			24697FE	2	\$209.09

COIL SPRINGS

	Est. Lift	Additional Load			
Medium - MWB	50mm	0 - 150kg	TOY049B	1	\$235.23
Heavy - LWB	50mm	150 - 300kg	TOY049C	1	\$217.80

SUSPENSION KIT

Medium - Nitro Gas	TOY048BKG	\$1045.44
Medium - Foam Cell	TOY048BKF	\$1306.80
Heavy - Nitro Gas	TOY048CKG	\$1045.44
Heavy - Foam Cell	TOY048CKF	\$1306.80

• Specify front Coil Springs when ordering

SUSPENSION KIT CONTENTS

Shock Absorbers

Coil Springs



1984 to 1989

SUSPENSION TO SUIT

Toyota Bundera

PRODUCT DESCRIPTION

PART NO.

QTY
Required

RETAIL
ea Incl GST

SUSPENSION TO SUIT TOYOTA BUNDERA

FRONT SUSPENSION

SHOCK ABSORBER

Nitro Gas - Performance			12091GR	2	\$143.75
Foam Cell - Performance			24091FE	2	\$209.09

COIL SPRINGS

	Est. Lift	Additional Load			
Medium	50mm	0 - 50kg	TOY018B	1	\$235.23

STEERING DAMPER

Foam Cell			3524	1	\$156.82
-----------	--	--	-------------	---	----------

REAR SUSPENSION

SHOCK ABSORBER

Nitro Gas - Performance	Left Hand Side		12639GRS	1	\$143.75
Nitro Gas - Performance	Right Hand Side		12650GR	1	\$143.75
Foam Cell - Performance	Left Hand Side		24639FES	1	\$209.09
Foam Cell - Performance	Right Hand Side		24650FE	1	\$209.09

COIL SPRINGS

	Est. Lift	Additional Load			
Medium	50mm	0 - 200kg	TOY019B	1	\$235.23

SUSPENSION KIT

Medium - Nitro Gas	TOY018BKG	\$1045.44
Medium - Foam Cell	TOY018BKF	\$1306.80

SUSPENSION KIT CONTENTS

Shock Absorbers Coil Springs



Toyota Landcruiser

71 Series (Coil/Leaf)
1999+



PRODUCT DESCRIPTION

PART NO.

QTY
Required

RETAIL
ea Incl GST

SUSPENSION TO SUIT TOYOTA LANDCRUISER

FRONT SUSPENSION

SHOCK ABSORBER

Nitro Gas - Performance			12091GR	2	\$143.75
Foam Cell - Performance			24091FE	2	\$209.09
Foam Cell Pro - Performance			45091FE	2	\$287.50
Foam Cell Pro - Professional			45091FEP	2	\$287.50

COIL SPRINGS

	Est. Lift	Additional Load			
Light	40mm	0 - 50kg	TOY046A	1	\$235.23
Medium	50mm	0 - 50kg	TOY046B	1	\$235.23
Heavy	50mm	50 - 110kg	TOY046C	1	\$235.23

STEERING DAMPER

Foam Cell			3525	1	\$156.82
-----------	--	--	-------------	---	----------

CASTER CORRECTION

2° Offset Bush Kit - Polyurethane			1144SK	1	\$143.75
Adjustable Offset STD, 2.5, 3.5 Degree - Polyurethane			1144	1	\$143.75
2° Offset Bush Kit - Rubber			1144RK	1	\$143.75

SWAY BAR LINK

Extended Sway Bar Link			SBEXT001	2	\$26.14
------------------------	--	--	-----------------	---	---------

COIL SPACER

Polyurethane 30mm			LC70F30	2	\$39.21
-------------------	--	--	----------------	---	---------

REAR SUSPENSION

SHOCK ABSORBER

Nitro Gas - Comfort			12081GRC	2	\$143.75
Nitro Gas - Performance			12081GR	2	\$143.75
Foam Cell - Comfort			24081FEC	2	\$209.09
Foam Cell - Performance			24081FE	2	\$209.09
Foam Cell - Professional			24081FEP	2	\$209.09
Foam Cell Pro - Comfort			45081FEC	2	\$287.50
Foam Cell Pro - Performance			45081FE	2	\$287.50
Foam Cell Pro - Professional			45081FEP	2	\$287.50

LEAF SPRINGS

	Est. Lift	Additional Load			
Light	50mm	0 - 150kg	TOY007AD/S	2	\$352.84
Medium	50mm	0 - 250kg	TOY007BD/S	2	\$352.84
Heavy	50mm	250kg - GVM	TOY007CD/S	2	\$378.98

U-BOLTS

U-Bolt Kit			415UBK	2	\$39.21
------------	--	--	---------------	---	---------

POLYURETHANE SPRING BUSHES

Bush Kit			1185UK	1	\$78.41
----------	--	--	---------------	---	---------

GREASABLE SHACKLES AND PINS

Greasable Shackle			1141-1	2	\$65.34
Greasable Shackle		Extra long	1141	2	\$65.34
Greasable Pin			1142	2	\$39.21

SUSPENSION KIT

Light - Nitro Gas			TOY058AKG		\$1672.71
Light - Foam Cell			TOY058AKF		\$1934.07
Light - Foam Cell Pro			TOY058AKP		\$2247.70
Medium - Nitro Gas			TOY058BKG		\$1672.71
Medium - Foam Cell			TOY058BKF		\$1934.07
Medium - Foam Cell Pro			TOY058BKP		\$2247.70
Heavy - Nitro Gas			TOY058CKG		\$1724.98
Heavy - Foam Cell			TOY058CKF		\$1986.34
Heavy - Foam Cell Pro			TOY058CKP		\$2299.97

• Specify front Coil Springs when ordering

SUSPENSION KIT CONTENTS

Shock Absorbers	Coil Springs	U-Bolts	Polyurethane Spring Bushes
Leaf Springs			



70, 73, 74 Series (Leaf/Leaf)
1984 to 1988

Toyota Landcruiser

PRODUCT DESCRIPTION

PART NO.

QTY
Required

RETAIL
ea Incl GST

SUSPENSION TO SUIT TOYOTA LANDCRUISER

FRONT SUSPENSION

SHOCK ABSORBER

Nitro Gas - Comfort			12637GRC	2	\$143.75
Nitro Gas - Performance			12637GR	2	\$143.75
Foam Cell - Comfort			24637FEC	2	\$209.09
Foam Cell - Performance			24637FE	2	\$209.09
Foam Cell Pro - Comfort			45637FEC	2	\$287.50
Foam Cell Pro - Performance			45637FE	2	\$287.50

LEAF SPRINGS

	Est. Lift	Additional Load			
Medium	50mm	0 - 100kg	TOY008B	2	\$352.84

STEERING DAMPER

Foam Cell			3524	1	\$156.82
-----------	--	--	-------------	---	----------

U-BOLTS

U-Bolt Kit			436UBK	2	\$39.21
------------	--	--	---------------	---	---------

POLYURETHANE SPRING BUSHES

Bush Kit			719UK	1	\$65.34
----------	--	--	--------------	---	---------

GREASABLE SHACKLES AND PINS

Greasable Shackle	Left Hand Side		348LH	1	\$65.34
Greasable Shackle	Right Hand Side		348RH	1	\$65.34
Greasable Pin			351	2	\$39.21

REAR SUSPENSION

SHOCK ABSORBER

Nitro Gas - Comfort			12650GRC	2	\$143.75
Nitro Gas - Performance			12650GR	2	\$143.75
Foam Cell - Comfort			24650FEC	2	\$209.09
Foam Cell - Performance			24650FE	2	\$209.09
Foam Cell - Professional			24650FEP	2	\$209.09
Foam Cell Pro - Comfort			45650FEC	2	\$287.50
Foam Cell Pro - Performance			45650FE	2	\$287.50
Foam Cell Pro - Professional			45650FEP	2	\$287.50

LEAF SPRINGS

	Est. Lift	Additional Load			
Light	50mm	0 - 200kg	TOY007AN/S	2	\$352.84
Medium	50mm	0 - 200kg	TOY007BN/S	2	\$352.84

U-BOLTS

U-Bolt Kit			415UBK	2	\$39.21
------------	--	--	---------------	---	---------

POLYURETHANE SPRING BUSHES

Bush Kit			719UK	1	\$65.34
----------	--	--	--------------	---	---------

GREASABLE SHACKLES AND PINS

Greasable Shackle	Left Hand Side		353LH	1	\$65.34
Greasable Shackle	Right Hand Side		353RH	1	\$65.34
Greasable Pin			354	2	\$39.21

HELPER SPRINGS

Load Plus Helper Springs			LP4	1	\$156.82
--------------------------	--	--	------------	---	----------

SUSPENSION KIT

Light - Nitro Gas			TOY016AKG		\$2273.84
Light - Foam Cell			TOY016AKF		\$2535.20
Light - Foam Cell Pro			TOY016AKP		\$2848.83
Medium - Nitro Gas			TOY016BKG		\$2273.84
Medium - Foam Cell			TOY016BKF		\$2535.20
Medium - Foam Cell Pro			TOY016BKP		\$2848.83

SUSPENSION KIT CONTENTS

Shock Absorbers

Leaf Springs

U-Bolts

Polyurethane Spring Bushes

Toyota Landcruiser

60 Series
11/1980 to 11/1989



PRODUCT DESCRIPTION

PART NO.

QTY
Required

RETAIL
ea Incl GST

ACCESSORIES TO SUIT TOYOTA LANDCRUISER

LOCKSAFE DRAWER SYSTEMS

Twin Drawers - 1000mm	ITD1000		\$1296.00
Single Drawer - 1000mm	ISD1000		\$783.00
Wing Kit - 1000mm	ITDW013		\$270.00

STEEL ROOF RACKS

Cage Style - 1.4m x 1.25m	IRRCAGE14		\$709.00
Cage Style - 1.8m x 1.25m	IRRCAGE18		\$744.00
Cage Style - 2.2m x 1.25m	IRRCAGE22		\$772.00
Rooftop Tent Compatible - 1.8m x 1.25m	IRRTENT18		\$709.00
Rooftop Tent Compatible - 2.2m x 1.25m	IRRTENT22		\$744.00
Trade Style - 1.8m x 1.25m (Open end)	IRRTRADE18		\$709.00
Trade Style - 2.2m x 1.25m (Open end)	IRRTRADE22		\$738.00

ALLOY ROOF RACKS

Cage Style - 1.4m x 1.25m	IRRCAGE14-ALLOY		\$897.00
Cage Style - 1.8m x 1.25m	IRRCAGE18-ALLOY		\$1049.00
Cage Style - 2.2m x 1.25m	IRRCAGE22-ALLOY		\$1106.00
Trade Style - 1.4m x 1.25m (Open end)	IRROPEN14-ALLOY		\$886.00
Trade Style - 1.8m x 1.25m (Open end)	IRRTRADE18-ALLOY		\$1033.00
Trade Style - 2.2m x 1.25m (Open end)	IRRTRADE22-ALLOY		\$1078.00
Flat Rack - 1.8m x 1.25m	IRRTFLAT18-ALLOY		\$1019.00

ROOF RACK - MOUNTING KITS

Gutter Mount Feet - 125mm (8 Feet)	IRRFEET125		\$180.00
------------------------------------	------------	--	----------

DIFF BREATHER KIT

Diff Breather Kit	IDIFFBRE		\$114.00
-------------------	----------	--	----------

SUSPENSION TO SUIT TOYOTA LANDCRUISER

FRONT SUSPENSION

SHOCK ABSORBER

Nitro Gas - Comfort	12637GRC	2	\$143.75
Nitro Gas - Performance	12637GR	2	\$143.75
Foam Cell - Comfort	24637FEC	2	\$209.09
Foam Cell - Performance	24637FE	2	\$209.09
Foam Cell Pro - Comfort	45637FEC	2	\$287.50
Foam Cell Pro - Performance	45637FE	2	\$287.50

LEAF SPRINGS

	Est. Lift	Additional Load			
Petrol	50mm	0 - 80kg	TOY006B	2	\$352.84
Diesel or Bullbar	50mm	50 - 100kg	TOY006C	2	\$378.98
Turbo Diesel	50mm	50 - 100kg	TOY006D	2	\$378.98

STEERING DAMPER

Foam Cell	3524	1	\$156.82
-----------	------	---	----------

U-BOLTS

U-Bolt Kit	436UBK	2	\$39.21
------------	--------	---	---------

POLYURETHANE SPRING BUSHES

Bush Kit	719UK	1	\$65.34
----------	-------	---	---------

GREASABLE SHACKLES AND PINS

Greasable Shackle	Left Hand Side	348LH	1	\$65.34
Greasable Shackle	Right Hand Side	348RH	1	\$65.34
Greasable Pin		351	2	\$39.21



60 Series
1986+

Toyota Landcruiser

PRODUCT DESCRIPTION

PART NO.

QTY
Required

RETAIL
ea Incl GST

REAR SUSPENSION

SHOCK ABSORBER

Nitro Gas - Comfort			12650GRC	2	\$143.75
Nitro Gas - Performance			12650GR	2	\$143.75
Foam Cell - Comfort			24650FEC	2	\$209.09
Foam Cell - Performance			24650FE	2	\$209.09
Foam Cell - Professional			24650FEP	2	\$209.09
Foam Cell Pro - Comfort			45650FEC	2	\$287.50
Foam Cell Pro - Performance			45650FE	2	\$287.50
Foam Cell Pro - Professional			45650FEP	2	\$287.50

LEAF SPRINGS

	Est. Lift	Additional Load			
Light - Drivers Side	50mm	0 - 200kg	TOY007AD/S	1	\$352.84
Light - Near Side	50mm	0 - 200kg	TOY007AN/S	1	\$352.84
Medium - Drivers Side	50mm	0 - 200kg	TOY007BD/S	1	\$352.84
Medium - Near Side	50mm	0 - 200kg	TOY007BN/S	1	\$352.84
Heavy - Drivers Side	50mm	200kg - GVM	TOY007CD/S	1	\$378.98
Heavy - Near Side	50mm	200kg - GVM	TOY007CN/S	1	\$378.98

• Side hinge barn door models may require (D/S-D/S) or (N/S-N/S) rear spring configuration to maintain level

U-BOLTS

U-Bolt Kit			415UBK	2	\$39.21
------------	--	--	--------	---	---------

POLYURETHANE SPRING BUSHES

Bush Kit			719UK	1	\$65.34
----------	--	--	-------	---	---------

GREASABLE SHACKLES AND PINS

Greasable Shackle	Left Hand Side		353LH	1	\$65.34
Greasable Shackle	Right Hand Side		353RH	1	\$65.34
Greasable Pin			351	2	\$39.21

HELPER SPRINGS

Load Plus Helper Springs			LP4	1	\$156.82
--------------------------	--	--	-----	---	----------

SUSPENSION KIT

Light - Nitro Gas	Petrol		TOY006AKG3		\$2273.84
Light - Foam Cell	Petrol		TOY006AKF3		\$2535.20
Light - Foam Cell Pro	Petrol		TOY006AKP3		\$2848.83
Light - Nitro Gas	Diesel		TOY006AKG2		\$2326.11
Light - Foam Cell	Diesel		TOY006AKF2		\$2587.47
Light - Foam Cell Pro	Diesel		TOY006AKP2		\$2901.10
Medium - Nitro Gas	Petrol		TOY006BKG2		\$2273.84
Medium - Foam Cell	Petrol		TOY006BKF2		\$2535.20
Medium - Foam Cell Pro	Petrol		TOY006BKP2		\$2848.83
Medium - Nitro Gas	Diesel		TOY006CKG2		\$2326.11
Medium - Foam Cell	Diesel		TOY006CKF2		\$2587.47
Medium - Foam Cell Pro	Diesel		TOY006CKP2		\$2901.10
Heavy - Nitro Gas	Petrol		TOY007BKG2		\$2326.11
Heavy - Foam Cell	Petrol		TOY007BKF2		\$2587.47
Heavy - Foam Cell Pro	Petrol		TOY007BKP2		\$2901.10
Heavy - Nitro Gas	Diesel		TOY007CKG2		\$2378.38
Heavy - Foam Cell	Diesel		TOY007CKF2		\$2639.74
Heavy - Foam Cell Pro	Diesel		TOY007CKP2		\$2953.37

SUSPENSION KIT CONTENTS

Shock Absorbers

Leaf Springs

U-Bolts

Polyurethane Spring Bushes

Toyota Landcruiser

60 Series
Pre 1986



PRODUCT DESCRIPTION

PART NO.

QTY
Required

RETAIL
ea Incl GST

SUSPENSION TO SUIT TOYOTA LANDCRUISER

FRONT SUSPENSION

SHOCK ABSORBER

Nitro Gas - Comfort			12637GRC	2	\$143.75
Nitro Gas - Performance			12637GR	2	\$143.75
Foam Cell - Comfort			24637FEC	2	\$209.09
Foam Cell - Performance			24637FE	2	\$209.09
Foam Cell Pro - Comfort			45637FEC	2	\$287.50
Foam Cell Pro - Performance			45637FE	2	\$287.50

LEAF SPRINGS

	Est. Lift	Additional Load			
Petrol	50mm	0 - 80kg	TOY006B	2	\$352.84
Diesel or Bullbar	50mm	50 - 100kg	TOY006C	2	\$378.98
Turbo Diesel	50mm	50 - 100kg	TOY006D	2	\$378.98

STEERING DAMPER

Foam Cell			3524	1	\$156.82
-----------	--	--	-------------	---	----------

U-BOLTS

U-Bolt Kit			436UBK	2	\$39.21
------------	--	--	---------------	---	---------

POLYURETHANE SPRING BUSHES

Bush Kit			719UK	1	\$65.34
----------	--	--	--------------	---	---------

GREASABLE SHACKLES AND PINS

Greasable Shackle	Left Hand Side		348LH	1	\$65.34
Greasable Shackle	Right Hand Side		348RH	1	\$65.34
Greasable Pin			351	2	\$39.21

REAR SUSPENSION

SHOCK ABSORBER

Nitro Gas - Comfort			12636GRC	2	\$143.75
Nitro Gas - Performance			12636GR	2	\$143.75
Nitro Gas - Professional			12636GRP	2	\$143.75
Foam Cell - Comfort			24636FEC	2	\$209.09
Foam Cell - Performance			24636FE	2	\$209.09
Foam Cell - Professional			24636FEP	2	\$209.09
Foam Cell Pro - Comfort			45636FEC	2	\$287.50
Foam Cell Pro - Performance			45636FE	2	\$287.50
Foam Cell Pro - Professional			45636FEP	2	\$287.50

LEAF SPRINGS

	Est. Lift	Additional Load			
Light - Drivers Side	50mm	0 - 200kg	TOY007AD/S	1	\$352.84
Light - Near Side	50mm	0 - 200kg	TOY007AN/S	1	\$352.84
Medium - Drivers Side	50mm	0 - 200kg	TOY007BD/S	1	\$352.84
Medium - Near Side	50mm	0 - 200kg	TOY007BN/S	1	\$352.84
Heavy - Drivers Side	50mm	200kg - GVM	TOY007CD/S	1	\$378.98
Heavy - Near Side	50mm	200kg - GVM	TOY007CN/S	1	\$378.98

• Side hinge barn door models may require (D/S-D/S) or (N/S-N/S) rear spring configuration to maintain level

U-BOLTS

U-Bolt Kit			415UBK	2	\$39.21
------------	--	--	---------------	---	---------

POLYURETHANE SPRING BUSHES

Bush Kit			719UK	1	\$65.34
----------	--	--	--------------	---	---------

GREASABLE SHACKLES AND PINS

Greasable Shackle	Left Hand Side		353LH	1	\$65.34
Greasable Shackle	Right Hand Side		353RH	1	\$65.34
Greasable Pin			351	2	\$39.21

HELPER SPRINGS

Load Plus Helper Springs			LP4	1	\$156.82
--------------------------	--	--	------------	---	----------



60 Series
Pre 1986

Toyota Landcruiser

PRODUCT DESCRIPTION

PART NO.

QTY
Required

RETAIL
ea Incl GST

SUSPENSION KIT

Light - Nitro Gas	Petrol	TOY006AKG	\$2273.84
Light - Nitro Gas	Diesel	TOY006AKG1	\$2326.11
Light - Foam Cell	Petrol	TOY006AKF	\$2535.20
Light - Foam Cell	Diesel	TOY006AKF1	\$2587.47
Light - Foam Cell Pro	Petrol	TOY006AKP	\$2848.83
Light - Foam Cell Pro	Diesel	TOY006AKP1	\$2901.10
Medium - Nitro Gas	Petrol	TOY006BKG1	\$2273.84
Medium - Nitro Gas	Diesel	TOY006CKG1	\$2326.11
Medium - Foam Cell	Petrol	TOY006BKF1	\$2535.20
Medium - Foam Cell	Diesel	TOY006CKF1	\$2587.47
Medium - Foam Cell Pro	Petrol	TOY006BKP1	\$2848.83
Medium - Foam Cell Pro	Diesel	TOY006CKP1	\$2901.10
Heavy - Nitro Gas	Petrol	TOY007BKG1	\$2326.11
Heavy - Nitro Gas	Diesel	TOY007CKG1	\$2378.38
Heavy - Foam Cell	Petrol	TOY007BKF1	\$2587.47
Heavy - Foam Cell	Diesel	TOY007CKF1	\$2639.74
Heavy - Foam Cell Pro	Petrol	TOY007BKP1	\$2901.10
Heavy - Foam Cell Pro	Diesel	TOY007CKP1	\$2953.37

SUSPENSION KIT CONTENTS

Shock Absorbers

Leaf Springs

U-Bolts

Polyurethane Spring Bushes



Toyota Landcruiser

45, 47 Series
8/1980 to 1985



PRODUCT DESCRIPTION

PART NO.

QTY
Required

RETAIL
ea Incl GST

SUSPENSION TO SUIT TOYOTA LANDCRUISER

FRONT SUSPENSION

SHOCK ABSORBER

Nitro Gas - Comfort			12635GRC	2	\$143.75
Nitro Gas - Performance			12635GR	2	\$143.75
Foam Cell - Comfort			24635FEC	2	\$193.60
Foam Cell - Performance			24635FE	2	\$209.09
Foam Cell Pro - Performance			45635FE	2	\$287.50

LEAF SPRINGS

	Est. Lift	Additional Load			
Medium	50mm	0 - 80kg	TOY004B	2	\$352.84
Heavy	50mm	80 - 120kg	TOY004C	2	\$352.84

STEERING DAMPER

Foam Cell			3523	1	\$156.82
-----------	--	--	-------------	---	----------

U-BOLTS

U-Bolt Kit		Drivers Side	449UBK	1	\$39.21
U-Bolt Kit		Near Side	415UBK	1	\$39.21

POLYURETHANE SPRING BUSHES

Bush Kit			719UK	1	\$65.34
----------	--	--	--------------	---	---------

GREASABLE SHACKLES AND PINS

Greasable Shackle			348LH	1	\$65.34
Greasable Shackle			348RH	1	\$65.34
Greasable Pin			351	2	\$39.21

REAR SUSPENSION

SHOCK ABSORBER

Nitro Gas - Comfort			12636GRC	2	\$143.75
Nitro Gas - Performance			12636GR	2	\$143.75
Nitro Gas - Professional			12636GRP	2	\$143.75
Foam Cell - Comfort			24636FEC	2	\$209.09
Foam Cell - Performance			24636FE	2	\$209.09
Foam Cell - Professional			24636FEP	2	\$209.09
Foam Cell Pro - Comfort			45636FEC	2	\$287.50
Foam Cell Pro - Performance			45636FE	2	\$287.50
Foam Cell Pro - Professional			45636FEP	2	\$287.50

LEAF SPRINGS

	Est. Lift	Additional Load			
Medium	50mm	0 - 400kg	TOY005C	2	\$575.00

U-BOLTS

U-Bolt Kit			415UBK	2	\$39.21
------------	--	--	---------------	---	---------

POLYURETHANE SPRING BUSHES

Bush Kit			719UK	1	\$65.34
----------	--	--	--------------	---	---------

GREASABLE SHACKLES AND PINS

Greasable Shackle		Left Hand Side	353LH	1	\$65.34
Greasable Shackle		Right Hand Side	353RH	1	\$65.34
Greasable Pin			351	2	\$39.21

HELPER SPRINGS

Load Plus Helper Springs			LP4	1	\$156.82
--------------------------	--	--	------------	---	----------

SUSPENSION KIT

Heavy - Nitro Gas			TOY005BKG		\$2718.15
Heavy - Foam Cell			TOY005BKF		\$2979.51
Heavy - Foam Cell Pro			TOY005BKP		\$3293.14

SUSPENSION KIT CONTENTS

Shock Absorbers

Leaf Springs

U-Bolts

Polyurethane Spring Bushes



45 Series
1960 to 1980

Toyota Landcruiser

PRODUCT DESCRIPTION

PART NO.

QTY
Required

RETAIL
ea Incl GST

SUSPENSION TO SUIT TOYOTA LANDCRUISER

FRONT SUSPENSION

SHOCK ABSORBER

Nitro Gas - Comfort			12635GRC	2	\$143.75
Nitro Gas - Performance			12635GR	2	\$143.75
Foam Cell - Comfort			24635FEC	2	\$193.60
Foam Cell - Performance			24635FE	2	\$209.09
Foam Cell Pro - Performance			45635FE	2	\$287.50

LEAF SPRINGS

	Est. Lift	Additional Load			
Medium	50mm	0 - 100kg	TOY001B	2	\$352.84

STEERING DAMPER

Foam Cell			3523	1	\$156.82
-----------	--	--	-------------	---	----------

U-BOLTS

U-Bolt Kit			415UBK	2	\$39.21
------------	--	--	---------------	---	---------

POLYURETHANE SPRING BUSHES

Bush Kit			713UK	1	\$65.34
----------	--	--	--------------	---	---------

GREASABLE SHACKLES AND PINS

Greasable Shackle	Left Hand Side		343LH	1	\$65.34
Greasable Shackle	Right Hand Side		343RH	1	\$65.34
Greasable Pin			346	2	\$39.21

REAR SUSPENSION

SHOCK ABSORBER

Nitro Gas - Comfort			12636GRC	2	\$143.75
Nitro Gas - Performance			12636GR	2	\$143.75
Nitro Gas - Professional			12636GRP	2	\$143.75
Foam Cell - Comfort			24636FEC	2	\$209.09
Foam Cell - Performance			24636FE	2	\$209.09
Foam Cell - Professional			24636FEP	2	\$209.09
Foam Cell Pro - Comfort			45636FEC	2	\$287.50
Foam Cell Pro - Performance			45636FE	2	\$287.50
Foam Cell Pro - Professional			45636FEP	2	\$287.50

LEAF SPRINGS

	Est. Lift	Additional Load			
Heavy	50mm	0 - 400kg	TOY003C	2	\$575.00

U-BOLTS

U-Bolt Kit			415UBK	2	\$39.21
------------	--	--	---------------	---	---------

POLYURETHANE SPRING BUSHES

Bush Kit			714UK	1	\$65.34
----------	--	--	--------------	---	---------

GREASABLE SHACKLES AND PINS

Greasable Shackle	Left Hand Side		344	1	\$65.34
Greasable Shackle	Right Hand Side		345	1	\$65.34
Greasable Pin			347	2	\$26.14

HELPER SPRINGS

Load Plus Helper Springs			LP4	1	\$156.82
--------------------------	--	--	------------	---	----------

SUSPENSION KIT

Heavy - Nitro Gas		TOY003BKG	\$2718.15
Heavy - Foam Cell		TOY003BKF	\$2979.51
Heavy - Foam Cell Pro		TOY003BKP	\$3293.14

SUSPENSION KIT CONTENTS

Shock Absorbers

Leaf Springs

U-Bolts

Polyurethane Spring Bushes

Toyota Landcruiser

40, 42, 46 Series
1980 to 1984



PRODUCT DESCRIPTION

PART NO.

QTY
Required

RETAIL
ea Incl GST

SUSPENSION TO SUIT TOYOTA LANDCRUISER

FRONT SUSPENSION

SHOCK ABSORBER

Nitro Gas - Comfort			12635GRC	2	\$143.75
Nitro Gas - Performance			12635GR	2	\$143.75
Foam Cell - Comfort			24635FEC	2	\$193.60
Foam Cell - Performance			24635FE	2	\$209.09
Foam Cell Pro - Performance			45635FE	2	\$287.50

LEAF SPRINGS

	Est. Lift	Additional Load			
Medium	50mm	0 - 80kg	TOY004B	2	\$352.84
Heavy	50mm	80 - 120kg	TOY004C	2	\$352.84

STEERING DAMPER

Foam Cell			3523	1	\$156.82
-----------	--	--	-------------	---	----------

U-BOLTS

U-Bolt Kit			415UBK	2	\$39.21
------------	--	--	---------------	---	---------

POLYURETHANE SPRING BUSHES

Bush Kit			719UK	1	\$65.34
----------	--	--	--------------	---	---------

GREASABLE SHACKLES AND PINS

Greasable Shackle	Left Hand Side		348LH	1	\$65.34
Greasable Shackle	Right Hand Side		348RH	1	\$65.34
Greasable Pin			351	2	\$39.21

REAR SUSPENSION

SHOCK ABSORBER

Nitro Gas - Comfort			12636GRC	2	\$143.75
Nitro Gas - Performance			12636GR	2	\$143.75
Nitro Gas - Professional			12636GRP	2	\$143.75
Foam Cell - Comfort			24636FEC	2	\$209.09
Foam Cell - Performance			24636FE	2	\$209.09
Foam Cell - Professional			24636FEP	2	\$209.09
Foam Cell Pro - Comfort			45636FEC	2	\$287.50
Foam Cell Pro - Performance			45636FE	2	\$287.50
Foam Cell Pro - Professional			45636FEP	2	\$287.50

LEAF SPRINGS

	Est. Lift	Additional Load			
Heavy	50mm	0 - 200kg	TOY034B	2	\$352.84

U-BOLTS

U-Bolt Kit			415UBK	2	\$39.21
------------	--	--	---------------	---	---------

POLYURETHANE SPRING BUSHES

Bush Kit			719UK	1	\$65.34
----------	--	--	--------------	---	---------

GREASABLE SHACKLES AND PINS

Greasable Shackle	Left Hand Side		348RH	1	\$65.34
Greasable Shackle	Right Hand Side		348LH	1	\$65.34
Greasable Pin			351	2	\$39.21

HELPER SPRINGS

Load Plus Helper Springs			LP4	1	\$156.82
--------------------------	--	--	------------	---	----------

SUSPENSION KIT

Medium - Nitro Gas			TOY004BKG		\$2273.84
Medium - Foam Cell			TOY004BKF		\$2535.20
Medium - Foam Cell Pro			TOY004BKP		\$2848.83

• Specify front Leaf Springs when ordering

SUSPENSION KIT CONTENTS

Shock Absorbers

Leaf Springs

U-Bolts

Polyurethane Spring Bushes



40 Series
1960 to 1980

Toyota Landcruiser

PRODUCT DESCRIPTION

PART NO.

QTY
Required

RETAIL
ea Incl GST

SUSPENSION TO SUIT TOYOTA LANDCRUISER

FRONT SUSPENSION

SHOCK ABSORBER

Nitro Gas - Comfort			12635GRC	2	\$143.75
Nitro Gas - Performance			12635GR	2	\$143.75
Foam Cell - Comfort			24635FEC	2	\$193.60
Foam Cell - Performance			24635FE	2	\$209.09
Foam Cell Pro - Performance			45635FE	2	\$287.50

LEAF SPRINGS

	Est. Lift	Additional Load			
Medium	50mm	0 - 100kg	TOY001B	2	\$352.84

STEERING DAMPER

Foam Cell			3523	1	\$156.82
-----------	--	--	-------------	---	----------

U-BOLTS

U-Bolt Kit			415UBK	2	\$39.21
------------	--	--	---------------	---	---------

POLYURETHANE SPRING BUSHES

Bush Kit			713UK	1	\$65.34
----------	--	--	--------------	---	---------

GREASABLE SHACKLES AND PINS

Greasable Shackle	Left Hand Side		343LH	1	\$65.34
Greasable Shackle	Right Hand Side		343RH	1	\$65.34
Greasable Pin			346	2	\$39.21

REAR SUSPENSION

SHOCK ABSORBER

Nitro Gas - Comfort			12636GRC	2	\$143.75
Nitro Gas - Performance			12636GR	2	\$143.75
Nitro Gas - Professional			12636GRP	2	\$143.75
Foam Cell - Comfort			24636FEC	2	\$209.09
Foam Cell - Performance			24636FE	2	\$209.09
Foam Cell - Professional			24636FEP	2	\$209.09
Foam Cell Pro - Comfort			45636FEC	2	\$287.50
Foam Cell Pro - Performance			45636FE	2	\$287.50
Foam Cell Pro - Professional			45636FEP	2	\$287.50

LEAF SPRINGS

	Est. Lift	Additional Load			
Medium	50mm	0 - 200kg	TOY002B	2	\$352.84

U-BOLTS

U-Bolt Kit			415UBK	2	\$39.21
------------	--	--	---------------	---	---------

POLYURETHANE SPRING BUSHES

Bush Kit			713UK	1	\$65.34
----------	--	--	--------------	---	---------

GREASABLE SHACKLES AND PINS

Greasable Shackle	Left Hand Side		343RH	1	\$65.34
Greasable Shackle	Right Hand Side		343LH	1	\$65.34
Greasable Pin			346	2	\$39.21

HELPER SPRINGS

Load Plus Helper Springs			LP4	1	\$156.82
--------------------------	--	--	------------	---	----------

SUSPENSION KIT

Medium - Nitro Gas		TOY001BKG	\$2273.84
Medium - Foam Cell		TOY001BKF	\$2535.20
Medium - Foam Cell Pro		TOY001BKP	\$2848.83

SUSPENSION KIT CONTENTS

Shock Absorbers

Leaf Springs

U-Bolts

Polyurethane Spring Bushes



PRODUCT DESCRIPTION

PART NO.

QTY
RequiredRETAIL
ea Incl GST

ACCESSORIES TO SUIT TOYOTA PRADO

STEEL WINCH BULL BARS

Premium - 60.3mm Tube	BBP064	\$2136.00
Proguard No Loop	BBT064-NL	\$1670.00
Proguard Single Loop Kit	BB064-SL	\$297.00
Proguard Triple Loop Kit	BB064-TL	\$357.00

• Winch with Steel Cable and Roller Fairlead is not suitable - Use Winch with Synthetic Rope and Alloy Hawse only

STEEL SIDE STEPS AND RAILS

Premium Side Steps - 60.3mm Tube	SSP064	\$933.00
Premium Side Rails - 60.3mm Tube	SSP064 RAIL	\$339.00
Premium Side Steps and Rails - 60.3mm Tube	SSRP064	\$1129.00

RECOVERY POINTS - IRONMAN 4X4 BULL BAR ONLY

Recovery Points - 5000kg Rating (Pair)	IRP064	\$300.00
--	--------	----------

LOCKSAFE DRAWER SYSTEMS

Twin Drawers - 900mm	ITD900	\$1242.00
Single Drawer - 900mm	ISD900	\$767.00
Wing Kit - 900mm	ITDW064	\$270.00
Mounting Kit	ITDFK064	\$152.00

BATTERY TRAY

Suits 12" Battery	IBTRAY064	\$138.00
-------------------	-----------	----------

SNORKEL

Engine 2.8 1GD-FTV Diesel	ISNORKELO64	\$387.00
---------------------------	-------------	----------

PREMIUM UNDERBODY PROTECTION

Engine Bay and Transmission for models without KDSS	UBP047	\$712.00
---	--------	----------

UNDERBODY PROTECTION

Engine Bay and Transmission for models without KDSS	IUP003K	\$562.00
Fuel Tank	IUP003F	\$273.00

• Fuel tank protection plates are not compatible with long range fuel tanks.

EXHAUST SYSTEM

3" Exhaust Upgrade 2.8L - DPF Back 2015+ - <i>While Stocks Last</i>	IEX064	\$770.00
---	--------	----------

STEEL ROOF RACKS

Cage Style - 1.8m x 1.25m	IRRCAGE18	\$744.00
Rooftop Tent Compatible - 1.8m x 1.25m	IRRTENT18	\$709.00
Trade Style - 1.8m x 1.25m (Open end)	IRRTRADE18	\$709.00

ALLOY ROOF RACKS

Cage Style - 1.8m x 1.25m	IRRCAGE18-ALLOY	\$1049.00
Trade Style - 1.8m x 1.25m (Open end)	IRRTRADE18-ALLOY	\$1033.00
Flat Rack - 1.8m x 1.25m	IRRTFLAT18-ALLOY	\$1019.00

ROOF RACK - MOUNTING KITS

Toyota Prado 150 Mount Feet (2 Feet)	IRRFEETPRADO150	\$199.00
--------------------------------------	-----------------	----------

SEAT COVER

Canvas Comfort - Front	ICSC047F	\$400.00
Canvas Comfort - Rear	ICSC047R	\$400.00

DIFF BREATHER KIT

Diff Breather Kit	IDIFFBRE	\$114.00
-------------------	----------	----------



150 Series (Coil)
12/2017+

SUSPENSION TO SUIT

Toyota Prado

PRODUCT DESCRIPTION

PART NO.

QTY
Required

RETAIL
ea Incl GST

SUSPENSION TO SUIT TOYOTA PRADO

FRONT SUSPENSION

SHOCK ABSORBER

Nitro Gas Strut - Performance			12710GR	2	\$209.09
Foam Cell Strut - Performance			24710FE	2	\$235.23
Foam Cell Pro Strut - Performance			45710FE	2	\$365.91

- Height adjustable with Ironman 4x4 Strut Trim Packers
- Foam Cell Pro, must fit 1198K or 1209K spacer for Sway Bar clearance

COIL SPRINGS

	Est. Lift	Additional Load			
Light	45mm	0 - 50kg	TOY065A	1	\$235.23
Medium	45mm	0 - 50kg	TOY065B	1	\$235.23
Heavy	45mm	50 - 110kg	TOY065C	1	\$235.23

STRUT MOUNTS

Steel Strut Top			ISST001	2	\$78.41
-----------------	--	--	----------------	---	---------

TRIM PACKERS

5mm Strut Trim Packer	Nitro Gas / Foam Cell	HILFR05 / HILFR05F	2	\$26.14
10mm Strut Trim Packer	Nitro Gas / Foam Cell	HILFR10 / HILFR10F	2	\$26.14
15mm Strut Trim Packer	Nitro Gas / Foam Cell	HILFR15 / HILFR15F	2	\$26.14

- ONLY Compatible with Ironman 4x4 Struts (except Pro), lift height subject to 2:1 motion ratio. Unnecessary fitment may lift vehicle too high

CONTROL ARMS

Pro-Forge Upper Control Arms			UCA001FA	1	\$831.60
------------------------------	--	--	-----------------	---	----------

SPACER KIT

Sway Bar Spacer			1198K	1	\$91.48
Offset Sway Bar Bracket			1209K	1	\$130.68

REAR SUSPENSION

SHOCK ABSORBER

Nitro Gas - Performance			12682GRC	2	\$143.75
Nitro Gas - Professional			12682GRP	2	\$143.75
Foam Cell - Performance			24682FEC	2	\$209.09
Foam Cell - Professional			24682FEP	2	\$209.09
Foam Cell Pro - Performance			45682FEC	2	\$287.50
Foam Cell Pro - Professional			45682FEP	2	\$287.50

COIL SPRINGS

	Est. Lift	Additional Load			
Medium	45mm	0 - 300kg	TOY056B	1	\$235.23
Medium - with Accessories	50mm	200 - 400kg	TOY069B	1	\$235.23
Heavy	45mm	300kg - GVM	TOY056C	1	\$235.23

PANHARD ROD

Adjustable Panhard Rod for models without KDSS			PANHARD015	1	\$300.57
Adjustable Panhard Rod for models with KDSS			PANHARD015-KDSS	1	\$300.57

COIL SPACER

Polyurethane 20mm			LCPR20	2	\$26.14
Polyurethane 25mm			LCPR25	2	\$39.21

SWAY BAR LINK

Extended Sway Bar Link for models without KDSS			SBEXT006	2	\$78.41
Rear Sway Bar Spacer for models with KDSS			1220K	1	\$133.10

BUMP STOP

Internal Rubber Cone			1218R	2	\$121.00
Airbag Delete Kit for models with Airbags			1218ADK	1	\$435.60

SUSPENSION KIT

Medium - Nitro Gas	TOY065BKG2	\$1176.12
Medium - Foam Cell	TOY065BKF2	\$1359.08
Medium - Foam Cell Pro	TOY065BKP2	\$1907.93
Heavy - Nitro Gas	TOY065CKG2	\$1176.12
Heavy - Foam Cell	TOY065CKF2	\$1359.08
Heavy - Foam Cell Pro	TOY065CKP2	\$1907.93

- All kits compatible with KDSS, refer KDSS instructions available at www.ironman4x4.com
- Specify front Coil Springs when ordering

SUSPENSION KIT CONTENTS

Shock Absorbers Coil Springs Strut Shock Absorbers Offset Sway Bar Bracket (Pro Kits Only)





built for adventure!

for a full range of accessories visit our website

www.ironman4x4.com



Toyota Prado

150 Series
11/2009 to 10/2013
11/2013 to 10/2017

PRODUCT DESCRIPTION

PART NO.

QTY
RequiredRETAIL
ea Incl GST

ACCESSORIES TO SUIT TOYOTA PRADO

STEEL WINCH BULL BARS

Commercial - (11/2009 to 10/2013) - <i>While Stocks Last</i>	BBC029	\$1598.00
Commercial* - (11/2013 to 10/2017) - <i>While Stocks Last</i>	BBC047	\$1598.00
Commercial Deluxe - (11/2009 to 10/2013)	BBCD029	\$2021.00
Commercial Deluxe* - (11/2013 to 10/2017)	BBCD047	\$2021.00
Protector - (11/2009 to 10/2013) - <i>While Stocks Last</i>	BBT029	\$2046.00
Polished Alloy* - (11/2013 to 10/2017) - <i>While Stocks Last</i>	BBA047	\$2517.00

* Not compatible with sensors or headlight washers.

STEEL SIDE STEPS AND RAILS

Side Steps	SS047	\$851.00
Side Steps and Rails	SSR047	\$1022.00

RECOVERY POINTS - IRONMAN 4X4 BULL BAR ONLY

Recovery Points - 5000kg Rating (Pair)	IRP064	\$300.00
--	--------	----------

LOCKSAFE DRAWER SYSTEMS

Twin Drawers - 900mm	ITD900	\$1242.00
Single Drawer - 900mm	ISD900	\$767.00
Wing Kit - 900mm	ITDW064	\$270.00
Mounting Kit	ITDFK064	\$152.00

BATTERY TRAY

Suits 12" Battery	IBTRAY064	\$138.00
-------------------	-----------	----------

SNORKEL

3L D4D TDi / 2.8L D4D TDi / 4L Petrol V6	ISNORKEL035	\$387.00
--	-------------	----------

PREMIUM UNDERBODY PROTECTION

Engine Bay and Transmission for models without KDSS	UBP047	\$712.00
---	--------	----------

UNDERBODY PROTECTION

Engine Bay and Transmission for models without KDSS	IUP003K	\$562.00
Fuel Tank	IUP003F	\$273.00

• Fuel tank protection plates are not compatible with long range fuel tanks.

EXHAUST SYSTEM

3" Exhaust Upgrade 2.8L - DPF Back 2015+ - <i>While Stocks Last</i>	IEX064	\$770.00
---	--------	----------

STEEL ROOF RACKS

Cage Style - 1.8m x 1.25m	IRRCAGE18	\$744.00
Rooftop Tent Compatible - 1.8m x 1.25m	IRRTENT18	\$709.00
Trade Style - 1.8m x 1.25m (Open end)	IRRTRADE18	\$709.00

ALLOY ROOF RACKS

Cage Style - 1.8m x 1.25m	IRRCAGE18-ALLOY	\$1049.00
Trade Style - 1.8m x 1.25m (Open end)	IRRTRADE18-ALLOY	\$1033.00
Flat Rack - 1.8m x 1.25m	IRRTFLAT18-ALLOY	\$1019.00

ROOF RACK - MOUNTING KITS

Toyota Prado 150 Mount Feet (2 Feet)	IRRFEETPRADO150	\$199.00
--------------------------------------	-----------------	----------

SEAT COVER

Canvas Comfort - Front	ICSC047F	\$400.00
Canvas Comfort - Rear	ICSC047R	\$400.00

DIFF BREATHER KIT

Diff Breather Kit	IDIFFBRE	\$114.00
-------------------	----------	----------

LISTING
CONTINUED
OVER THE
PAGE



PRODUCT DESCRIPTION

PART NO.

QTY
Required

RETAIL
ea Incl GST

SUSPENSION TO SUIT TOYOTA PRADO

FRONT SUSPENSION

SHOCK ABSORBER

Nitro Gas Strut - Performance			12750GR	2	\$209.09
Foam Cell Strut - Performance			24750FE	2	\$235.23
Foam Cell Pro Strut - Performance			45750FE	2	\$365.91

- Height adjustable with Ironman 4x4 Strut Trim Packers
- Foam Cell Pro, must fit 1198K or 1209K spacer for Sway Bar clearance

COIL SPRINGS

	Est. Lift	Additional Load			
Light	45mm	0 - 50kg	TOY065A	1	\$235.23
Medium - Petrol	45mm	0 - 50kg	TOY065B	1	\$235.23
Heavy - Diesel	45mm	50 - 110kg	TOY065C	1	\$235.23

STRUT MOUNTS

Steel Strut Top			ISST001	2	\$78.41
-----------------	--	--	----------------	---	---------

TRIM PACKERS

5mm Strut Trim Packer	Nitro Gas / Foam Cell	HILFR05 / HILFR05F	2	\$26.14
10mm Strut Trim Packer	Nitro Gas / Foam Cell	HILFR10 / HILFR10F	2	\$26.14
15mm Strut Trim Packer	Nitro Gas / Foam Cell	HILFR15 / HILFR15F	2	\$26.14

- ONLY Compatible with Ironman 4x4 Struts (except Pro), lift height subject to 2:1 motion ratio. Unnecessary fitment may lift vehicle too high

CONTROL ARMS

Pro-Forge Upper Control Arms		UCA001FA	1	\$831.60
------------------------------	--	-----------------	---	----------

SPACER KIT

Sway Bar Spacer		1198K	1	\$91.48
Offset Sway Bar Bracket		1209K	1	\$130.68

REAR SUSPENSION

SHOCK ABSORBER

Nitro Gas - Performance			12682GRC	2	\$143.75
Nitro Gas - Professional			12682GRP	2	\$143.75
Foam Cell - Performance			24682FEC	2	\$209.09
Foam Cell - Professional			24682FEP	2	\$209.09
Foam Cell Pro - Performance			45682FEC	2	\$287.50
Foam Cell Pro - Professional			45682FEP	2	\$287.50

COIL SPRINGS

	Est. Lift	Additional Load			
Medium - SWB	45mm	0 - 300kg	TOY056A	1	\$235.23
Medium - LWB	45mm	0 - 300kg	TOY056B	1	\$235.23
Medium - LWB with Accessories	50mm	200 - 400kg	TOY069B	1	\$235.23
Heavy	45mm	300kg - GVM	TOY056C	1	\$235.23

PANHARD ROD

Adjustable Panhard Rod for models without KDSS		PANHARD015	1	\$300.57
Adjustable Panhard Rod for models with KDSS		PANHARD015-KDSS	1	\$300.57

COIL SPACER

Polyurethane 20mm		LCPR20	2	\$26.14
Polyurethane 25mm		LCPR25	2	\$39.21

SWAY BAR LINK

Extended Sway Bar Link for models without KDSS		SBEXT006	2	\$78.41
Rear Sway Bar Spacer for models with KDSS		1220K	1	\$133.10

BUMP STOP

Internal Rubber Cone		1218R	2	\$121.00
Airbag Delete Kit for models with Airbags		1218ADK	1	\$435.60

Toyota Prado

120 Series
4/2003 to 10/2009



PRODUCT DESCRIPTION

PART NO.

QTY
Required

RETAIL
ea Incl GST

ACCESSORIES TO SUIT TOYOTA PRADO

STEEL WINCH BULL BARS

Commercial Deluxe	BBCD008		\$1985.00
Protector - <i>While Stocks Last</i>	BBT008		\$2009.00

STEEL SIDE STEPS AND RAILS

Side Steps	SS017		\$851.00
Side Steps and Rails	SSR004		\$1022.00

LOCKSAFE DRAWER SYSTEMS

Twin Drawers - 900mm	ITD900		\$1242.00
Single Drawer - 900mm	ISD900		\$767.00

SNORKEL

3L D4D TDi / 4L Petrol V6	ISNORKEL006		\$387.00
---------------------------	-------------	--	----------

STEEL ROOF RACKS

Cage Style - 1.8m x 1.25m	IRRCAGE18		\$744.00
Rooftop Tent Compatible - 1.8m x 1.25m	IRRTENT18		\$709.00
Trade Style - 1.8m x 1.25m (Open end)	IRRTRADE18		\$709.00

ALLOY ROOF RACKS

Cage Style - 1.8m x 1.25m	IRRCAGE18-ALLOY		\$1049.00
Trade Style - 1.8m x 1.25m (Open end)	IRRTRADE18-ALLOY		\$1033.00
Flat Rack - 1.8m x 1.25m	IRRTFLAT18-ALLOY		\$1019.00

ROOF RACK - MOUNTING KITS

Gutter Mount Feet - 200mm (8 Feet)	IRRFEETLC200		\$180.00
------------------------------------	--------------	--	----------

UNDERBODY PROTECTION

Engine Bay and Transmission	IUP002K		\$562.00
-----------------------------	---------	--	----------

DIFF BREATHER KIT

Diff Breather Kit	IDIFFBRE		\$114.00
-------------------	----------	--	----------

SUSPENSION TO SUIT TOYOTA PRADO

FRONT SUSPENSION

SHOCK ABSORBER

Nitro Gas Strut - Performance	12710GR	2	\$209.09
Foam Cell Strut - Performance	24710FE	2	\$235.23
Foam Cell Pro Strut - Performance	45710FE	2	\$365.91

• Height adjustable with Ironman 4x4 Strut Trim Packers

• Foam Cell Pro, must fit 1198K spacer for Sway Bar clearance

COIL SPRINGS

	Est. Lift	Additional Load	Part No.	QTY	Price
Light	30mm	0 - 50kg	TOY055A	1	\$235.23
Medium - Petrol	45mm	0 - 50kg	TOY055B	1	\$235.23
Heavy - Diesel	45mm	50 - 110kg	TOY055C	1	\$235.23

STRUT MOUNTS

Steel Strut Top	ISST001	2	\$78.41
-----------------	---------	---	---------

TRIM PACKERS

5mm Strut Trim Packer	Nitro Gas / Foam Cell	HILFR05 / HILFR05F	2	\$26.14
10mm Strut Trim Packer	Nitro Gas / Foam Cell	HILFR10 / HILFR10F	2	\$26.14
15mm Strut Trim Packer	Nitro Gas / Foam Cell	HILFR15 / HILFR15F	2	\$26.14

• ONLY Compatible with Ironman 4x4 Struts (except Pro), lift height subject to 2:1 motion ratio. Unnecessary fitment may lift vehicle too high

CONTROL ARMS

Pro-Forge Upper Control Arms	UCA001FA	1	\$831.60
------------------------------	----------	---	----------

SPACER KIT

Sway Bar Spacer	1198K	1	\$91.48
-----------------	-------	---	---------

Toyota Prado

120 Series
4/2003 to 10/2009

PRODUCT DESCRIPTION

PART NO.

QTY
RequiredRETAIL
ea Incl GST

REAR SUSPENSION

SHOCK ABSORBER

Nitro Gas - Performance			12682GRC	2	\$143.75
Nitro Gas - Professional			12682GRP	2	\$143.75
Foam Cell - Performance			24682FEC	2	\$209.09
Foam Cell - Professional			24682FEP	2	\$209.09
Foam Cell Pro - Performance			45682FEC	2	\$287.50
Foam Cell Pro - Professional			45682FEP	2	\$287.50

COIL SPRINGS

	Est. Lift	Additional Load			
Medium - SWB	45mm	0 - 300kg	TOY056A	1	\$235.23
Medium - LWB	45mm	0 - 300kg	TOY056B	1	\$235.23
Medium - with accessories LWB	50mm	200 - 400kg	TOY069B	1	\$235.23
Heavy	45mm	300kg - GVM	TOY056C	1	\$235.23

PANHARD ROD

Adjustable Panhard Rod for models without KDSS			PANHARD015	1	\$300.57
Adjustable Panhard Rod for models with KDSS			PANHARD015-KDSS	1	\$300.57

SWAY BAR LINK

Extended Sway Bar Link for models without KDSS			SBEXT006	2	\$78.41
Rear Sway Bar Spacer for models with KDSS			1220K	1	\$133.10

BUMP STOP

Internal Rubber Cone			1218R	2	\$121.00
Airbag Delete Kit for models with Airbags			1218ADK	1	\$435.60

SUSPENSION KIT

Medium - Nitro Gas	SWB	Petrol	TOY055AKG		\$1176.12
Medium - Nitro Gas	SWB	Diesel	TOY055AKG1		\$1176.12
Medium - Nitro Gas	LWB	Petrol	TOY055BKG		\$1176.12
Medium - Nitro Gas	LWB	Diesel	TOY055BKG1		\$1176.12
Medium - Foam Cell	SWB	Petrol	TOY055AKF		\$1359.08
Medium - Foam Cell	SWB	Diesel	TOY055AKF1		\$1359.08
Medium - Foam Cell	LWB	Petrol	TOY055BKF		\$1359.08
Medium - Foam Cell	LWB	Diesel	TOY055BKF1		\$1359.08
Medium - Foam Cell Pro	SWB	Petrol	TOY055AKP		\$1907.93
Medium - Foam Cell Pro	SWB	Diesel	TOY055AKP1		\$1868.73
Medium - Foam Cell Pro	LWB	Petrol	TOY055BKP		\$1907.93
Medium - Foam Cell Pro	LWB	Diesel	TOY055BKP1		\$1868.73
Heavy - Nitro Gas	LWB	Petrol	TOY055CKG		\$1176.12
Heavy - Nitro Gas	LWB	Diesel	TOY055CKG1		\$1176.12
Heavy - Foam Cell	LWB	Petrol	TOY055CKF		\$1359.08
Heavy - Foam Cell	LWB	Diesel	TOY055CKF1		\$1359.08
Heavy - Foam Cell Pro	LWB	Petrol	TOY055CKP		\$1907.93
Heavy - Foam Cell Pro	LWB	Diesel	TOY055CKP1		\$1868.73

- Specify front Coil Springs when ordering

SUSPENSION KIT CONTENTS

Shock Absorbers

Strut Shock Absorbers

Coil Springs

Sway Bar Spacer (Pro Kits Only)

Toyota Prado

90, 95 Series
1996 to 10/2002



PRODUCT DESCRIPTION

PART NO.

QTY
Required

RETAIL
ea Incl GST

ACCESSORIES TO SUIT TOYOTA PRADO

STEEL WINCH BULL BARS

Commercial Deluxe	BBCD007	\$1985.00
-------------------	---------	-----------

SNORKEL

3.4L Petrol V6	ISNORKEL005	\$387.00
----------------	-------------	----------

LOCKSAFE DRAWER SYSTEMS

Twin Drawers - 900mm	ITD900	\$1242.00
----------------------	--------	-----------

Single Drawer - 900mm	ISD900	\$767.00
-----------------------	--------	----------

Wing Kit - 900mm (GXL)	ITDW004	\$270.00
------------------------	---------	----------

STEEL ROOF RACKS

Cage Style - 1.8m x 1.25m	IRRCAGE18	\$744.00
---------------------------	-----------	----------

Rooftop Tent Compatible - 1.8m x 1.25m	IRRTENT18	\$709.00
--	-----------	----------

Trade Style - 1.8m x 1.25m (Open end)	IRRTRADE18	\$709.00
---------------------------------------	------------	----------

ALLOY ROOF RACKS

Cage Style - 1.8m x 1.25m	IRRCAGE18-ALLOY	\$1049.00
---------------------------	-----------------	-----------

Trade Style - 1.8m x 1.25m (Open end)	IRRTRADE18-ALLOY	\$1033.00
---------------------------------------	------------------	-----------

Flat Rack - 1.8m x 1.25m	IRRTFLAT18-ALLOY	\$1019.00
--------------------------	------------------	-----------

ROOF RACK - MOUNTING KITS

Gutter Mount Feet - 125mm (8 Feet)	IRRFEET125	\$180.00
------------------------------------	------------	----------

DIFF BREATHER KIT

Diff Breather Kit	IDIFFBRE	\$114.00
-------------------	----------	----------



Toyota Prado

90, 95 Series
1996 to 10/2002

PRODUCT DESCRIPTION

PART NO.

QTY
RequiredRETAIL
ea Incl GST

SUSPENSION TO SUIT TOYOTA PRADO

FRONT SUSPENSION

SHOCK ABSORBER

Nitro Gas Strut - Performance			12691GR	2	\$209.09
Foam Cell Strut - Performance			24691FE	2	\$235.23
Foam Cell Pro Strut - Performance			45691FE	2	\$365.91

- Height adjustable with Ironman 4x4 Strut Trim Packers

COIL SPRINGS

	Est. Lift	Additional Load			
Medium - Petrol	45mm	0 - 50kg	TOY038B	1	\$235.23
Heavy - Diesel	45mm	50 - 110kg	TOY038C	1	\$235.23

TRIM PACKERS

5mm Strut Trim Packer	Nitro Gas / Foam Cell	HILFR05 / HILFR05F	2	\$26.14
10mm Strut Trim Packer	Nitro Gas / Foam Cell	HILFR10 / HILFR10F	2	\$26.14
15mm Strut Trim Packer	Nitro Gas / Foam Cell	HILFR15 / HILFR15F	2	\$26.14

- ONLY Compatible with Ironman 4x4 Struts (except Pro), lift height subject to 2:1 motion ratio. Unnecessary fitment may lift vehicle too high

REAR SUSPENSION

SHOCK ABSORBER

Nitro Gas - Performance			12661GR	2	\$143.75
Foam Cell - Performance			24661FE	2	\$209.09
Foam Cell Pro - Performance			45661FE	2	\$287.50

COIL SPRINGS

	Est. Lift	Additional Load			
Medium - SWB	45mm	0 - 300kg	TOY039A	1	\$235.23
Medium - LWB	45mm	0 - 300kg	TOY039B	1	\$235.23
Heavy	45mm	300kg - GVM	TOY039C	1	\$235.23

COIL SPACER

Polyurethane 20mm			LCF20	2	\$26.14
Polyurethane 30mm			LCF30	2	\$39.21

SUSPENSION KIT

Medium - Nitro Gas	SWB	Petrol	TOY038AKG		\$1176.12
Medium - Nitro Gas	SWB	Diesel	TOY038AKG1		\$1176.12
Medium - Nitro Gas	LWB	Petrol	TOY038BKG		\$1176.12
Medium - Nitro Gas	LWB	Diesel	TOY038CKG		\$1176.12
Medium - Foam Cell	SWB	Petrol	TOY038AKF		\$1359.08
Medium - Foam Cell	SWB	Diesel	TOY038AKF1		\$1359.08
Medium - Foam Cell	LWB	Petrol	TOY038BKF		\$1359.08
Medium - Foam Cell	LWB	Diesel	TOY038CKF		\$1359.08
Medium - Foam Cell Pro	SWB	Petrol	TOY038AKP		\$1777.25
Medium - Foam Cell Pro	SWB	Diesel	TOY038AKP1		\$1777.25
Medium - Foam Cell Pro	LWB	Petrol	TOY038BKP		\$1777.25
Medium - Foam Cell Pro	LWB	Diesel	TOY038CKP		\$1777.25
Heavy - Nitro Gas	LWB	Petrol	TOY038BKG1		\$1176.12
Heavy - Nitro Gas	LWB	Diesel	TOY038CKG1		\$1176.12
Heavy - Foam Cell	LWB	Petrol	TOY038BKF1		\$1359.08
Heavy - Foam Cell	LWB	Diesel	TOY038CKF1		\$1359.08
Heavy - Foam Cell Pro	LWB	Petrol	TOY038BKP1		\$1777.25
Heavy - Foam Cell Pro	LWB	Diesel	TOY038CKP1		\$1777.25

- Specify front Coil Springs when ordering

SUSPENSION KIT CONTENTS

Shock Absorbers

Strut Shock Absorbers

Coil Springs

Toyota Tacoma

2005+



PRODUCT DESCRIPTION

DATE AVAILABLE

PART NO.

QTY
Required

RETAIL
ea Incl GST

ACCESSORIES TO SUIT TOYOTA TACOMA

STEEL WINCH BULL BARS

Raid Bull Bar*	Q2 2021	BBR072	\$1040.00
----------------	---------	--------	-----------

* Compatible with Ironman 4x4 Cube Lights and Lightbars, refer below for available options

LIGHTING OPTIONS - TO SUIT RAID BULL BARS (4-6 CUBE LIGHTS PER VEHICLE)

300W Bright Sabre Dual Row Lightbar 815mm	Q2 2021	ILBDR002B	\$399.00
300W Bright Sabre Multi-Function Dual Row Lightbar 815mm	Q2 2021	ILBDR002BM	\$449.00
40W Bright Cube Spot Beam LED Cube Light - 81 x 75mm - Clear	Q2 2021	ILED80B	\$79.00
40W Bright Cube Spot Beam LED Cube Light - 81 x 75mm - Amber	Q2 2021	ILED80BA	\$79.00
40W Bright Cube Flood Beam LED Cube Light - 81 x 75mm - Clear	Q2 2021	ILED80BF	\$79.00
40W Bright Cube Flood Beam LED Cube Light - 81 x 75mm - Amber	Q2 2021	ILED80BFA	\$79.00
10W Spot Beam Universal LED Light - 93mm L - Clear (3rd Light)		ILEDWL10	\$47.00
10W Flood Beam Universal LED Light - 93mm L - Amber (3rd Light)	Q2 2021	ILEDWL10FA	\$47.00

STEEL SIDE STEPS

Raid Rock Slider*	Q2 2021	SS072	\$848.00
-------------------	---------	-------	----------

TOWING

Raid Rear Bumper*	Q2 2021	RTB072	\$950.00
-------------------	---------	--------	----------

* Compatible with Ironman 4x4 Cube Lights, refer below for available options

LIGHTING OPTIONS - TO SUIT RAID REAR BARS (4 CUBE LIGHTS PER VEHICLE)

20W Bright Cube Spot Beam LED Cube Light - 70 x 64mm (Each) - Clear	Q2 2021	ILED20B	\$59.00
20W Bright Cube Spot Beam LED Cube Light - 70 x 64mm (Each) - Amber	Q2 2021	ILED20BA	\$59.00
20W Bright Cube Flood Beam LED Cube Light - 70 x 64mm (Each) - Clear	Q2 2021	ILED20BF	\$59.00
20W Bright Cube Flood Beam LED Cube Light - 70 x 64mm (Each) - Amber	Q2 2021	ILED20BFA	\$59.00
20W Bright Cube Flood Beam LED Cube Light - 70 x 64mm (Each) - Red	Q2 2021	ILED20BFR	\$59.00

PREMIUM UNDERBODY PROTECTION

Engine Bay and Transmission		UBP072	\$712.00
-----------------------------	--	--------	----------

DIFF BREATHER KIT

Diff Breather Kit		IDIFFBRE	\$114.00
-------------------	--	----------	----------



Toyota Tacoma



2005+

PRODUCT DESCRIPTION

PART NO.

QTY
RequiredRETAIL
ea Incl GST

SUSPENSION TO SUIT TOYOTA TACOMA

FRONT SUSPENSION

SHOCK ABSORBER

Nitro Gas Strut - Performance			12710GR	2	\$209.09
Foam Cell Strut - Performance			24710FE	2	\$235.23
Foam Cell Pro Strut - Performance			45710FE	2	\$365.91

- Height adjustable with Ironman 4x4 Strut Trim Packers

COIL SPRINGS

	Est. L ift	Additional Load			
Light	45mm	0 - 50kg	TOY065A	1	\$235.23
Medium	45mm	0 - 50kg	TOY065B	1	\$235.23
Heavy	45mm	50 - 110kg	TOY065C	1	\$235.23

STRUT MOUNTS

Steel Strut Top			ISST001	2	\$78.41
-----------------	--	--	----------------	---	---------

TRIM PACKERS

5mm Strut Trim Packer	Nitro Gas / Foam Cell	HILFR05 / HILFR05F	2	\$26.14
10mm Strut Trim Packer	Nitro Gas / Foam Cell	HILFR10 / HILFR10F	2	\$26.14
15mm Strut Trim Packer	Nitro Gas / Foam Cell	HILFR15 / HILFR15F	2	\$26.14

- ONLY Compatible with Ironman 4x4 Struts (except Pro), lift height subject to 2:1 motion ratio. Unnecessary fitment may lift vehicle too high

CONTROL ARMS

Pro-Forge Upper Control Arms			UCA001FA	1	\$831.60
------------------------------	--	--	-----------------	---	----------

SPACER KIT

Offset Sway Bar Bracket			1209K	1	\$130.68
-------------------------	--	--	--------------	---	----------

REAR SUSPENSION

SHOCK ABSORBER

Nitro Gas - Performance			12744GR	2	\$143.75
Foam Cell - Performance			24744FE	2	\$209.09
Foam Cell Pro - Performance			45744FE	2	\$287.50

LEAF SPRINGS

	Est. Lift	Additional Load			
Medium - Drivers Side	50mm	0 - 200kg	TOY066BD/S	1	\$483.52
Medium - Near Side	50mm	0 - 200kg	TOY066BN/S	1	\$483.52
Heavy - Drivers Side	50mm	200kg-GVM	TOY066CD/S	1	\$483.52
Heavy - Near Side	50mm	200kg-GVM+	TOY066CN/S	1	\$483.52

U-BOLTS

U-Bolt Kit			437UBK	2	\$39.21
------------	--	--	---------------	---	---------

POLYURETHANE SPRING BUSHES

Bush Kit			1191UK	1	\$78.41
----------	--	--	---------------	---	---------

SPACER KIT

Centre Bearing Spacer Kit			1192K	1	\$26.14
---------------------------	--	--	--------------	---	---------

HELPER SPRINGS

Load Plus Helper Springs			LP3	1	\$156.82
Add-A-Leaf			ISL6010	1	\$156.82

SUSPENSION KIT

Medium - Nitro Gas	TOY066BKG	\$2090.88
Medium - Foam Cell	TOY066BKF	\$2273.84
Medium - Foam Cell Pro	TOY066BKP	\$2692.01
Heavy - Nitro Gas	TOY066CKG	\$2090.88
Heavy - Foam Cell	TOY066CKF	\$2273.84
Heavy - Foam Cell Pro	TOY066CKP	\$2692.01

- Specify front Coil Springs when ordering

SUSPENSION KIT CONTENTS

Shock Absorbers	Coil Springs	Polyurethane Spring Bushes	Strut Shock Absorbers
Leaf Springs	U-Bolts	Centre Bearing Spacer Kit	



PRODUCT DESCRIPTION

DATE AVAILABLE

PART NO.

QTY
Required

RETAIL
ea Incl GST

ACCESSORIES TO SUIT TOYOTA TUNDRA

STEEL WINCH BULL BARS

Raid Bull Bar*	Q2 2021	BBR073	\$1260.00
----------------	---------	--------	-----------

* Compatible with Ironman 4x4 Cube Lights and Lightbars, refer below for available options

LIGHTING OPTIONS - TO SUIT RAID BULL BARS (4-6 CUBE LIGHTS PER VEHICLE)

300W Bright Sabre Dual Row Lightbar 815mm	Q2 2021	ILBDR002B	\$399.00
300W Bright Sabre Multi-Function Dual Row Lightbar 815mm	Q2 2021	ILBDR002BM	\$449.00
40W Bright Cube Spot Beam LED Cube Light - 81 x 75mm - Clear	Q2 2021	ILED80B	\$79.00
40W Bright Cube Spot Beam LED Cube Light - 81 x 75mm - Amber	Q2 2021	ILED80BA	\$79.00
40W Bright Cube Flood Beam LED Cube Light - 81 x 75mm - Clear	Q2 2021	ILED80BF	\$79.00
40W Bright Cube Flood Beam LED Cube Light - 81 x 75mm - Amber	Q2 2021	ILED80BFA	\$79.00
10W Spot Beam Universal LED Light - 93mm L - Clear (3rd Light)		ILEDWL10	\$47.00
10W Flood Beam Universal LED Light - 93mm L - Amber (3rd Light)	Q2 2021	ILEDWL10FA	\$47.00

STEEL SIDE STEPS

Raid Rock Slider	Q2 2021	SS073	\$848.00
------------------	---------	-------	----------

TOWING

Raid Rear Bumper*	Q2 2021	RTB073	\$950.00
-------------------	---------	--------	----------

* Compatible with Ironman 4x4 Cube Lights, refer below for available options

LIGHTING OPTIONS - TO SUIT RAID REAR BARS (4 CUBE LIGHTS PER VEHICLE)

20W Bright Cube Spot Beam LED Cube Light - 70 x 64mm (Each) - Clear	Q2 2021	ILED20B	\$59.00
20W Bright Cube Spot Beam LED Cube Light - 70 x 64mm (Each) - Amber	Q2 2021	ILED20BA	\$59.00
20W Bright Cube Flood Beam LED Cube Light - 70 x 64mm (Each) - Clear	Q2 2021	ILED20BF	\$59.00
20W Bright Cube Flood Beam LED Cube Light - 70 x 64mm (Each) - Amber	Q2 2021	ILED20BFA	\$59.00
20W Bright Cube Flood Beam LED Cube Light - 70 x 64mm (Each) - Red	Q2 2021	ILED20BFR	\$59.00

PREMIUM UNDERBODY PROTECTION

Engine Bay and Transmission		UBP073	\$712.00
-----------------------------	--	--------	----------

DIFF BREATHER KIT

Diff Breather Kit		IDIFFBRE	\$114.00
-------------------	--	----------	----------



Toyota Tundra

2006 to 2021

PRODUCT DESCRIPTION

PART NO.

QTY
RequiredRETAIL
ea Incl GST

SUSPENSION TO SUIT TOYOTA TUNDRA

FRONT SUSPENSION

SHOCK ABSORBER

Foam Cell Strut - Performance			24780FE	2	\$261.36
Foam Cell Pro Strut - Performance			45780FE	2	\$365.91

- Height adjustable with Ironman 4x4 Strut Trim Packers
- Foam Cell Pro - Must use TOY063B or TOY063C Front Coil Springs

COIL SPRINGS

	Est. Lift	Additional Load			
Medium	60mm	0 - 50kg	TOY070B	1	\$235.23
Heavy	60mm	50 - 110kg	TOY070C	1	\$235.23

- Not compatible with Foam Cell Pro, refer note above

STRUT MOUNTS

Steel Strut Top			ISST005	2	\$78.41
-----------------	--	--	----------------	---	---------

TRIM PACKERS

5mm Strut Trim Packer	Foam Cell		HILFR05F	2	\$26.14
10mm Strut Trim Packer	Foam Cell		HILFR10F	2	\$26.14
15mm Strut Trim Packer	Foam Cell		HILFR15F	2	\$26.14

- ONLY Compatible with Ironman 4x4 Struts (except Pro), lift height subject to 2:1 motion ratio. Unnecessary fitment may lift vehicle too high

CONTROL ARMS

Pro-Forge Upper Control Arms			UCA073FA	1	\$831.60
------------------------------	--	--	-----------------	---	----------

REAR SUSPENSION

SHOCK ABSORBER

Foam Cell - Performance			24781FE	2	\$209.09
Foam Cell Pro - Performance			45781FE	2	\$287.50

LEAF SPRINGS

	Est. Lift	Additional Load			
Medium	60mm	0 - 200kg	TOY071B	2	\$470.45
Heavy	60mm	200 - 400kg	TOY071C	2	\$483.52

U-BOLTS

U-Bolt Kit			678UBK	2	\$39.21
------------	--	--	---------------	---	---------

POLYURETHANE SPRING BUSHES

Bush Kit			1196UK	1	\$78.41
----------	--	--	---------------	---	---------

DRIVELINE SPACERS

Centre Bearing Spacer Kit			1217K	1	\$26.14
---------------------------	--	--	--------------	---	---------

SPACER KIT

Brake Hose Relocation Kit			1197K	1	\$39.21
---------------------------	--	--	--------------	---	---------

GREASABLE SHACKLES AND PINS

Greasable Shackle			1150	2	\$39.21
-------------------	--	--	-------------	---	---------

HELPER SPRINGS

Load Plus Helper Springs			LP3	1	\$156.82
--------------------------	--	--	------------	---	----------

SUSPENSION KIT

Medium - Foam Cell			TOY070BKF		\$2313.04
Medium - Foam Cell Pro			TOY070BKP		\$2678.94
Heavy - Foam Cell			TOY070CKF		\$2339.18
Heavy - Foam Cell Pro			TOY070CKP		\$2705.08

- Specify front Coil Springs when ordering

SUSPENSION KIT CONTENTS

Shock Absorbers	Coil Springs	Polyurethane Spring Bushes	Strut Shock Absorbers
Leaf Springs	U-Bolts	Brake Hose Relocation Kit	

Troller T4

7/2014+



PRODUCT DESCRIPTION

PART NO.

QTY
Required

RETAIL
ea Incl GST

SUSPENSION TO SUIT TROLLER T4

FRONT SUSPENSION

SHOCK ABSORBER

Nitro Gas - Performance			12755GR	2	\$133.10
-------------------------	--	--	----------------	---	----------

COIL SPRINGS

Medium	Est. Lift 50mm	Additional Load 0 - 50kg	TROL001B	1	\$205.70
--------	-------------------	-----------------------------	-----------------	---	----------

REAR SUSPENSION

SHOCK ABSORBER

Nitro Gas - Performance			12755GR	2	\$133.10
-------------------------	--	--	----------------	---	----------

COIL SPRINGS

Medium	Est. Lift 50mm	Additional Load 0 -200kg	TROL002B	1	\$205.70
--------	-------------------	-----------------------------	-----------------	---	----------

SUSPENSION KIT

Medium - Nitro Gas			TROL001BKG		\$1045.44
--------------------	--	--	-------------------	--	-----------

SUSPENSION KIT CONTENTS

Shock Absorbers	Coil Springs
-----------------	--------------



1997 to 6/2014

SUSPENSION TO SUIT

Troller T4

PRODUCT DESCRIPTION

PART NO.

QTY
Required

RETAIL
ea Incl GST

SUSPENSION TO SUIT TROLLER T4

FRONT SUSPENSION

SHOCK ABSORBER

Nitro Gas - Performance

12765GR

2

\$133.10

COIL SPRINGS

Est. Lift

Additional Load

Medium

45mm

0 - 50kg

TROL003B

1

\$205.70

REAR SUSPENSION

SHOCK ABSORBER

Nitro Gas - Performance

12765GR

2

\$133.10

COIL SPRINGS

Est. Lift

Additional Load

Medium

45mm

0 - 200kg

TROL004B

1

\$205.70

SUSPENSION KIT

Medium - Nitro Gas

TROL003BKG

\$1045.44

SUSPENSION KIT CONTENTS

Shock Absorbers

Coil Springs





PRODUCT DESCRIPTION

PART NO.

QTY
Required

RETAIL
ea Incl GST

SUSPENSION TO SUIT UAZ HUNTER

FRONT SUSPENSION

SHOCK ABSORBER

Nitro Gas - Performance			12652GR	2	\$143.75
Foam Cell - Performance			24652FE	2	\$209.09

COIL SPRINGS

	Est. Lift	Additional Load			
Medium	45mm	0 - 80kg	IMAZ001B	1	\$217.80

REAR SUSPENSION

SHOCK ABSORBER

Nitro Gas - Performance			12698GR	2	\$143.75
Foam Cell - Performance			24698FE	2	\$209.09

LEAF SPRINGS

	Est. Lift	Additional Load			
Medium	45mm	0 - 300kg	IMAZ002B	2	\$278.30

U-BOLTS

U-Bolt Kit			678UBK	2	\$39.21
------------	--	--	---------------	---	---------

POLYURETHANE SPRING BUSHES

Bush Kit			1188UK	1	\$78.41
----------	--	--	---------------	---	---------

GREASABLE SHACKLES AND PINS

Greasable Shackle			1189	2	\$65.34
-------------------	--	--	-------------	---	---------

SUSPENSION KIT

Medium - Nitro Gas			IMAZ001BKG		\$2064.75
Medium - Foam Cell			IMAZ001BKF		\$2326.11

SUSPENSION KIT CONTENTS

Shock Absorbers	Coil Springs	Polyurethane Spring Bushes
Leaf Springs	U-Bolts	Shackles





1997+

PRODUCT DESCRIPTION

PART NO.

QTY
Required

RETAIL
ea Incl GST

SUSPENSION TO SUIT UAZ HUNTER

FRONT SUSPENSION

SHOCK ABSORBER

Nitro Gas - Performance			12637GRS	2	\$143.75
Foam Cell - Performance			24637FES	2	\$209.09

COIL SPRINGS

	Est. Lift	Additional Load			
Medium	45mm	0 - 80kg	IMAZ001B	1	\$217.80

REAR SUSPENSION

SHOCK ABSORBER

Nitro Gas - Performance			12698GR	2	\$143.75
Foam Cell - Performance			24698FE	2	\$209.09

LEAF SPRINGS

	Est. Lift	Additional Load			
Medium	45mm	0 - 300kg	IMAZ002B	2	\$278.30

U-BOLTS

U-Bolt Kit			678UBK	2	\$39.21
------------	--	--	---------------	---	---------

POLYURETHANE SPRING BUSHES

Bush Kit			1188UK	1	\$78.41
----------	--	--	---------------	---	---------

GREASABLE SHACKLES AND PINS

Greasable Shackle			1189	2	\$65.34
-------------------	--	--	-------------	---	---------

SUSPENSION KIT

Medium - Nitro Gas			IMAZ001BKG1		\$2064.75
Medium - Foam Cell			IMAZ001BKF1		\$2326.11

SUSPENSION KIT CONTENTS

Shock Absorbers	Coil Springs	Polyurethane Spring Bushes
Leaf Springs	U-Bolts	Greasable Shackles





PRODUCT DESCRIPTION

PART NO.

QTY
RequiredRETAIL
ea Incl GST

ACCESSORIES TO SUIT VOLKSWAGEN AMAROK

STEEL WINCH BULL BARS

Commercial - <i>While Stocks Last</i>	BBC060	\$1598.00
Commercial Deluxe	BBCD060	\$2021.00
Proguard No Loop	BBT060-NL	\$1670.00
Proguard Single Loop Kit	BB060-SL	\$297.00
Proguard Triple Loop Kit	BB060-TL	\$357.00
Driving Light Patch Loom	IPLO60	\$30.00

• Can also be fitted to both 2WD and 4WD models.

STEEL SIDE STEPS AND RAILS

Side Steps	SS034	\$851.00
Side Rails	SS034 RAIL	\$280.00
Side Steps and Rails	SSR034	\$1022.00

TOWING

Rear Protection Towbar - Full Rear Bumper Replacement	RTB060	\$1196.00
Towbar Wiring Loom - Plug and Play	ITBL060	\$400.00

LOCKSAFE DRAWER SYSTEMS

Twin Drawers - 1300mm	ITD1300	\$1469.00
Single Drawer - 1300mm	ISD1300	\$891.00
Wing Kit - 1300mm	ITDW060	\$351.00

SNORKEL

Amarok	ISNORKELO37	\$387.00
--------	--------------------	----------

EXHAUST SYSTEM

3" Exhaust Upgrade 3.0L V6 - DPF Back - <i>While Stocks Last</i>	IEX060	\$770.00
--	---------------	----------

CANOPY - ABS PLASTIC (SIDE LIFT UP WINDOWS) - FITS 4X4 AND 4X2 DUAL CAB MODELS

Pre-Primed	CANOPY021-P	\$3143.00*
Candy White (B4B4)	CANOPY021-W	\$3743.00

* Pre-primed canopies, plus colour coding.

SEAT COVER

Canvas Comfort - Front	ICSC060F	\$400.00
Canvas Comfort - Rear	ICSC060R	\$400.00

DIFF BREATHER KIT

Diff Breather Kit	IDIFFBRE	\$114.00
-------------------	-----------------	----------





V6 / 4 Cylinder
11/2016+

Volkswagen Amarok

PRODUCT DESCRIPTION

PART NO.

QTY
Required

RETAIL
ea Incl GST

SUSPENSION TO SUIT VOLKSWAGEN AMAROK

FRONT SUSPENSION

SHOCK ABSORBER

Nitro Gas Strut - Performance **12725GR** 2 \$209.09

• Height adjustable with Ironman 4x4 Strut Trim Packers

COIL SPRINGS

	Est. Lift	Additional Load			
Medium - 4cyl	30mm	0 - 50kg	VOLKS001B	1	\$235.23
Heavy - V6	30mm	50 - 110kg	VOLKS001C	1	\$235.23
Heavy - V6	30mm	50 - 110kg	VOLKS001D	1	\$235.23

TRIM PACKERS

5mm Strut Trim Packer		Nitro Gas	HILFR05	2	\$26.14
10mm Strut Trim Packer		Nitro Gas	HILFR10	2	\$26.14
15mm Strut Trim Packer		Nitro Gas	HILFR15	2	\$26.14

• ONLY Compatible with Ironman 4x4 Struts, lift height subject to 2:1 motion ratio. Unnecessary fitment may lift vehicle too high

REAR SUSPENSION

SHOCK ABSORBER

Nitro Gas - Performance **12726GR** 2 \$143.75

LEAF SPRINGS

	Est. Lift	Additional Load			
Medium	35mm	0 - 300kg	VOLKS002B	2	\$352.84
Heavy	35mm	200 - 400kg	VOLKS002C	2	\$378.98

U-BOLTS

U-Bolt Kit **415UBK** 2 \$39.21

POLYURETHANE SPRING BUSHES

Bush Kit 32mm Shackles Bushes **1190UK** 1 \$78.41

HELPER SPRINGS

Load Plus Helper Springs **LP4** 1 \$156.82

SUSPENSION KIT

Medium - Nitro Gas **VOLKS001BKG** \$1803.39
 Heavy - Nitro Gas **VOLKS001CKG** \$1855.66

• Specify front Coil Springs when ordering

SUSPENSION KIT CONTENTS

Shock Absorbers
Leaf Springs

Coil Springs
U-Bolts

Polyurethane Spring Bushes
Strut Shock Absorbers



PRODUCT DESCRIPTION

PART NO.

QTY
RequiredRETAIL
ea Incl GST

ACCESSORIES TO SUIT VOLKSWAGEN AMAROK

STEEL WINCH BULL BARS

Commercial - <i>While Stocks Last</i>	BBC034	\$1598.00
Commercial Deluxe	BBCD034	\$2021.00
Protector - <i>While Stocks Last</i>	BBT034	\$2046.00
Driving Light Patch Loom	IPL060	\$30.00

• Can also be fitted to both 2WD and 4WD models.

STEEL SIDE STEPS AND RAILS

Side Steps	SS034	\$851.00
Side Rails	SS034 RAIL	\$280.00
Side Steps and Rails	SSR034	\$1022.00

TOWING

Rear Protection Towbar - Full Rear Bumper Replacement	RTB060	\$1196.00
Towbar Wiring Loom - Plug and Play	ITBL060	\$400.00

LOCKSAFE DRAWER SYSTEMS

Twin Drawers - 1300mm	ITD1300	\$1469.00
Single Drawer - 1300mm	ISD1300	\$891.00
Wing Kit - 1300mm*	ITDW040	\$351.00

*Designed to suit factory tubs, will not suit ute liner without modification.

SNORKEL

Amarok	ISNORKELO37	\$387.00
--------	-------------	----------

UNDERBODY PROTECTION

Engine Bay and Transmission	IUP012K	\$636.00
-----------------------------	---------	----------

CANOPY - ABS PLASTIC (SIDE LIFT UP WINDOWS) - FITS 4X4 AND 4X2 DUAL CAB MODELS

Pre-Primed	CANOPY021-P	\$3143.00*
Candy White (B4B4)	CANOPY021-W	\$3743.00

*Pre-primed canopies, plus colour coding.

SEAT COVER

Canvas Comfort - Front	ICSC060F	\$400.00
Canvas Comfort - Rear	ICSC060R	\$400.00

DIFF BREATHER KIT

Diff Breather Kit	IDIFFBRE	\$114.00
-------------------	----------	----------





1997 to 10/2016

Volkswagen Amarok

PRODUCT DESCRIPTION

PART NO.

QTY
Required

RETAIL
ea Incl GST

SUSPENSION TO SUIT VOLKSWAGEN AMAROK

FRONT SUSPENSION

SHOCK ABSORBER

Nitro Gas Strut - Performance **12725GR** 2 \$209.09

• Height adjustable with Ironman 4x4 Strut Trim Packers

COIL SPRINGS

	Est. Lift	Additional Load			
Medium - 4cyl	30mm	0 - 50kg	VOLKS001B	1	\$235.23
Heavy - V6	30mm	50 - 110kg	VOLKS001C	1	\$235.23
Heavy - V6	30mm	50 - 110kg	VOLKS001D	1	\$235.23

TRIM PACKERS

5mm Strut Trim Packer	Nitro Gas	HILFR05	2	\$26.14
10mm Strut Trim Packer	Nitro Gas	HILFR10	2	\$26.14
15mm Strut Trim Packer	Nitro Gas	HILFR15	2	\$26.14

• ONLY Compatible with Ironman 4x4 Struts, lift height subject to 2:1 motion ratio. Unnecessary fitment may lift vehicle too high

REAR SUSPENSION

SHOCK ABSORBER

Nitro Gas - Performance **12726GR** 2 \$143.75

LEAF SPRINGS

	Est. Lift	Additional Load			
Medium	35mm	0 - 300kg	VOLKS002B	2	\$352.84
Heavy	35mm	200 - 400kg	VOLKS002C	2	\$378.98

U-BOLTS

U-Bolt Kit **415UBK** 2 \$39.21

POLYURETHANE SPRING BUSHES

Bush Kit 32mm Shackles Bushes **1190UK** 1 \$78.41

HELPER SPRINGS

Load Plus Helper Springs **LP4** 1 \$156.82

SUSPENSION KIT

Medium - Nitro Gas **VOLKS001BKG** \$1803.39
 Heavy - Nitro Gas **VOLKS001CKG** \$1855.66

• Specify front Coil Springs when ordering

SUSPENSION KIT CONTENTS

Shock Absorbers
Leaf Springs

Coil Springs
U-Bolts

Polyurethane Spring Bushes
Strut Shock Absorbers



redefining 4x4 suspension!

for a full range of suspension visit our website

www.ironman4x4.com



Accessory Spare Parts

CATALOGUE AND PRICE LIST

Effective 1 May 2021

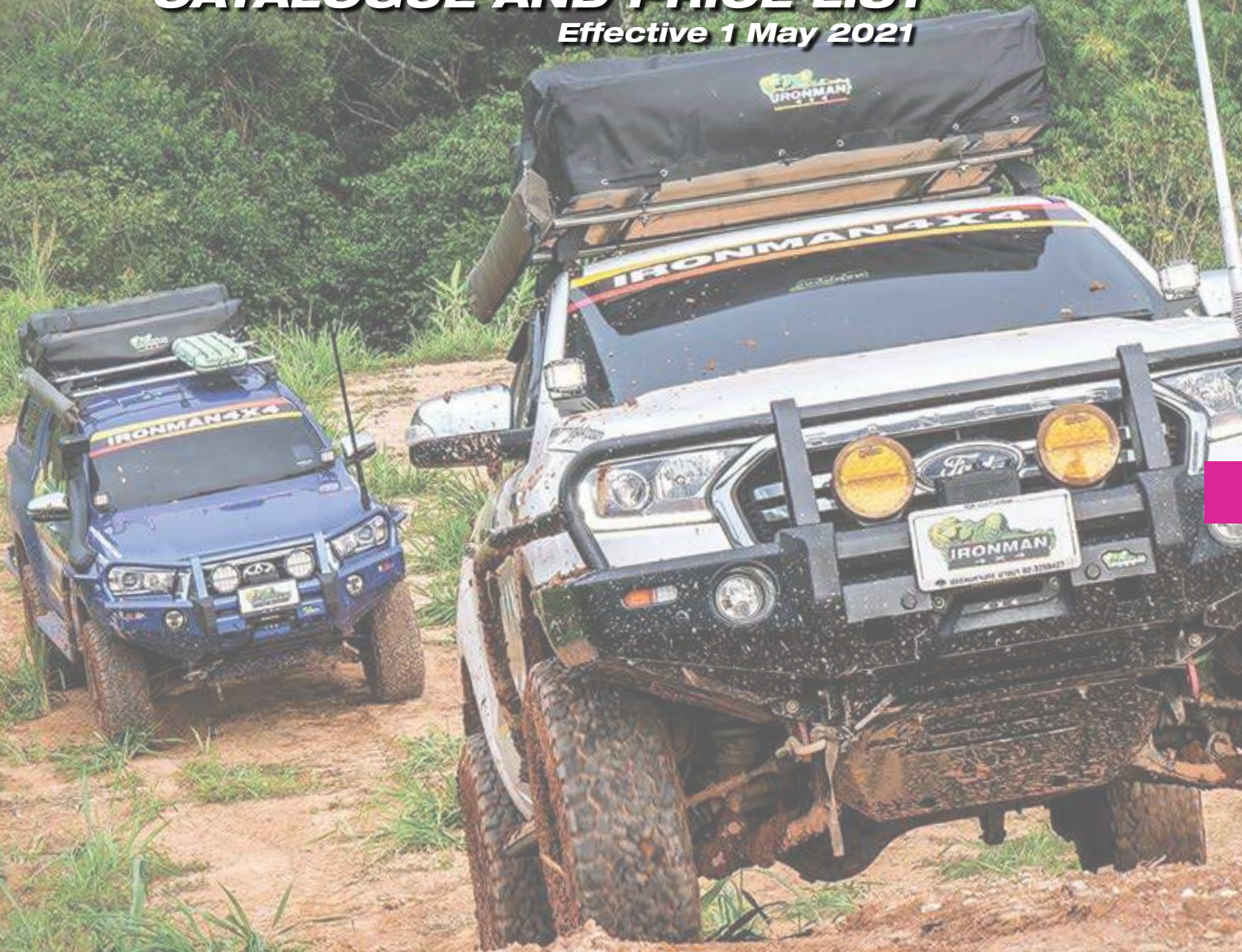

Spare Parts

PRODUCT DESCRIPTION	PART NO.	QTY Required	RETAIL ea Incl GST
BULL BARS			
Bullbar Indicator - LED Park/Indicator/DRL (Pair)	BBPART002		\$165.00
1m Pinch Weld for Bumper Cut	BBPART006		\$5.00
Bull Bar Fog Light - Halogen (Pair)	BBPART008		\$122.00
Plastic Light Pod & Bracket - Old Style Triangle Unit (Each)	BBPART009		\$85.00
Plastic Light Pod Surround L/H	BBPART009 L/H		\$43.00
Plastic Light Pod Surround R/H	BBPART009 R/H		\$43.00
Bumper Override for BBT - New Style (Pair)	BBPART010		\$75.00
Bumper Override for BBC (Pair)	BBPART011		\$75.00
Wiring Loom - New Style	BBPART012		\$53.00
Plastic Inserts to sui Hilux Vigo BB002 (Pair)	BBPART013		\$15.00
Ironman 4x4 Bull Bar Logo Badge	BBPART014		\$4.00
Bumper Override for BBC/ BBCD033 to BBC/ BBCD049	BBPART015		\$75.00
Indicator Light Brackets	BBPART017		\$2.00
Ironman 4x4 Logo Resin Style SS/ SSR Rails	BBPART019		\$3.00
Bumper Override for BBCD035	BBPART020		\$75.00
Washer Bottle to Suit BBC050/ BBCD050/ BBT050	BBPART021		\$38.00
Single Light Pod Insert & Bracket	BBPART022		\$85.00
Plastic Light Pod Insert L/H (Single)	BBPART022-LH		\$43.00
Plastic Light Pod Insert R/H (Single)	BBPART022-RH		\$43.00
Bull Bar Loop O-Ring Kit	BBPART023		\$9.00
Bumper Override For BBC051/ BBCD051 onwards	BBPART024		\$75.00
Bumper Override for BBT051 onwards	BBPART025		\$75.00
Licence Plate Bracket	BBPART026		\$22.00
Bull Bar LED Fog Light (Pair)	BBPART031		\$109.00
Load Resistor Kit with Mount Brackets for 12V/21W Indicator/Parker Replacement	LR12V21W		\$49.00
Triple Stainless Steel Loop for BBT001	BBPARTLOOP001		\$281.00
Triple Stainless Steel Loop for BBT002	BBPARTLOOP002		\$281.00
Triple Stainless Steel Loop for BBT003	BBPARTLOOP003		\$281.00
Triple Stainless Steel Loop for BBT004	BBPARTLOOP004		\$281.00
Triple Stainless Steel Loop for BBT005/ 006	BBPARTLOOP005		\$281.00
Triple Stainless Steel Loop for BBT007	BBPARTLOOP007		\$281.00
Triple Stainless Steel Loop for BBT008	BBPARTLOOP008		\$281.00
Triple Stainless Steel Loop for BBT009	BBPARTLOOP009		\$281.00
Triple Stainless Steel Loop for BBT010	BBPARTLOOP010		\$281.00
Triple Stainless Steel Loop for BBT011	BBPARTLOOP011		\$281.00
Triple Stainless Steel Loop for BBT012	BBPARTLOOP012		\$281.00
Triple Stainless Steel Loop for BBT013	BBPARTLOOP013		\$281.00
Triple Stainless Steel Loop for BBT014	BBPARTLOOP014		\$281.00
Triple Stainless Steel Loop for BBT016	BBPARTLOOP016		\$281.00
Triple Stainless Steel Loop for BBT019	BBPARTLOOP019		\$281.00
Triple Stainless Steel Loop for BBT020	BBPARTLOOP020		\$281.00
Triple Stainless Steel Loop for BBT024	BBPARTLOOP024		\$281.00
Triple Stainless Steel Loop for BBT025	BBPARTLOOP025		\$281.00
Triple Stainless Steel Loop for BBT027	BBPARTLOOP027		\$281.00
Triple Stainless Steel Loop for BBT029	BBPARTLOOP029		\$281.00
Triple Stainless Steel Loop for BBT031	BBPARTLOOP031		\$281.00
Triple Stainless Steel Loop for BBT033	BBPARTLOOP033		\$281.00
Triple Stainless Steel Loop for BBT034	BBPARTLOOP034		\$281.00
Triple Stainless Steel Loop for BBT037	BBPARTLOOP037		\$281.00
Triple Stainless Steel Loop for BBT038	BBPARTLOOP038		\$281.00
Triple Stainless Steel Loop for BBT039	BBPARTLOOP039		\$281.00
Triple Stainless Steel Loop for BBT040	BBPARTLOOP040		\$281.00
Triple Stainless Steel Loop for BBT041	BBPARTLOOP041		\$281.00
Triple Stainless Steel Loop for BBT042	BBPARTLOOP042		\$281.00
Triple Stainless Steel Loop for BBT043	BBPARTLOOP043		\$281.00
Triple Stainless Steel Loop for BBT044	BBPARTLOOP044		\$281.00
Triple Stainless Steel Loop for BBT045	BBPARTLOOP045		\$281.00



Spare Parts

PRODUCT DESCRIPTION	PART NO.	QTY Required	RETAIL ea Incl GST
Triple Stainless Steel Loop for BBT047	BBPARTLOOP047		\$281.00
Triple Stainless Steel Loop for BBT048	BBPARTLOOP048		\$281.00
Triple Stainless Steel Loop for BBT049	BBPARTLOOP049		\$281.00
Triple Stainless Steel Loop for BBT050	BBPARTLOOP050		\$281.00
Triple Stainless Steel Loop for BBT051	BBPARTLOOP051		\$281.00
Triple Stainless Steel Loop for BBT054	BBPARTLOOP054		\$281.00
Triple Stainless Steel Loop for BBT056/ 056xv	BBPARTLOOP056		\$281.00
Triple Stainless Steel Loop for BBT057	BBPARTLOOP057		\$281.00
Triple Stainless Steel Loop for BBT058	BBPARTLOOP058		\$281.00

WINCHES

Remote With Wireless Receiver Unit for WWB9500/ 12000	WWB001		\$94.00
Solenoid (All models)	WWB002		\$75.00
Motor for WWB9500	WWB003		\$225.00
Motor with Brake Attachment for WWB9500	WWB003B		\$225.00
Motor for WWB12000 - New	WWB004		\$244.00
Motor with Brake Attachment for WWB12000	WWB004B		\$244.00
Diff Breather Kit for WWB9500/ 12000	WWB005		\$12.00
Tie Bars New Shape (2 Pc) (All models)	WWB006		\$12.00
Clutch Handle (All models)	WWB007		\$12.00
Gearbox Complete for WWW9500/ WWB9500	WWB008		\$262.00
Gearbox Complete for WWW12000/ WWB12000	WWB009		\$262.00
Brush Kit For Motor (All models)	WWB010		\$26.00
Replacement Hook (All models)	WWB011		\$29.00
Drum Support Housing Motor End (All models)	WWB012		\$38.00
Drum Support Housing Gearbox End (All models)	WWB013		\$38.00
Complete Control Box With Remote (All models)	WWB014		\$300.00
Wireless Plug (All models)	WWB015		\$5.00
Winch Cam Lock Brake System for WWW9500/ 12000	WWB016		\$12.00
Winch Drum (All models)	WWB017		\$57.00
Electric Motor Gasket (All models)	WWB018		\$2.00
Control Box Lead Socket for WWB9500/ 12000	WWB023		\$12.00
Plug In Lead for WWB9500/ 12000	WWB024		\$19.00
Internal Brake Replacement for WWW9500/ 12000	WWB025		\$57.00
Ferrule and Pin for Winch Hook	WWB026		\$13.00
Winch Damper Blanket (All models)	WINCH BLANKET		\$38.00
Winch Cam-Lock Brake System for WWB9500/ 12000	WWWBRAKE		\$85.00
Steel Cable (28m x 11mm) for WWW12000/ WWB12000	WWWCABLE 12		\$204.00
Steel Cable (28m x 8mm) for WWW9500/ WWB9500	WWWCABLE 95		\$221.00
Winch Clutch Handle	WWWCLUTCH		\$12.00
Drum For Winches	WWWDRUM		\$57.00
Drum Support Bush	WWWDRUMBUSH		\$8.00
End Plate For Gear Box	WWWENDPLATE GBOX		\$38.00
End Plate For Motor	WWWENDPLATE MOTOR		\$38.00
Fairlead Rollers For Ironman Winch	WWWFAIRLEAD		\$75.00
12000lb Winch Motor	WWWMOTOR12		\$225.00
9500lb Winch Motor	WWWMOTOR95		\$225.00
O-Ring For Inside The Drum For The Brake	WWWORING		\$6.00
Wireless Remote For Winch	WWWREMOTE WIRELESS		\$57.00
Steel Cable Lug for WWW12000/ WWB12000	WWWTAG12		\$4.00
Steel Cable Lug for WWW9500/ WWB9500	WWWTAG95		\$4.00
12000lb Winch Carton	WWW CARTON12		\$17.00
9500lb Winch Carton	WWW CARTON95		\$17.00
Box for WWB9500	WWB019		\$2.00
Box for WWW9500SR	WWB020		\$2.00
Box for WWB12000	WWB021		\$2.00
Box for WWB12000SR	WWB022		\$2.00

• Replacement Battery A23 - Not a Spare Part

Spare Parts

PRODUCT DESCRIPTION	PART NO.	QTY Required	RETAIL ea Incl GST
TOW BARS			
Tow Bar Tongue and Ball	RTBSPARE002		\$89.00
LED Numberplate Light	RTBSPARE003		\$14.00
Plastic Sensor Cover to suit RTB067GLS	RTBSPARE004		\$22.00
DRIVING LIGHTS			
H11 35W 6000k Bulb for IHID001	IHIDBULB		\$113.00
Bull Bar Light Mount Bracket for Blast Series Driving Light	ILEDBLASTMOUNT		\$9.50
Bull Bar Light Mount Bracket for Comet Series Driving Light	ILEDCOMETMOUNT		\$9.50
CANOPIES			
Mount Kit for CANOPY014	CANOPY MOUNT KIT 014		\$163.00
Mount Kit for CANOPY015	CANOPY MOUNT KIT 015		\$163.00
Rear Door Handle & Key Set (For Non Central Locking Models)	CANOPYSPARE001		\$161.00
Rear Window Gas Strut CANOPY001/ 002/ 005/ 006/ 007 (Pair)	CANOPYSPARE002		\$100.00
Rear Window Gas Strut for CANOPY003/ 004 (Pair)	CANOPYSPARE003		\$129.00
Plate Side Lock Set All Models to CANOPY008 (Striker)	CANOPYSPARE004		\$40.00
Canopy Internal Light (All Models)	CANOPYSPARE005		\$36.00
Rubber Seal Kit Suits All to CANOPY007	CANOPYSPARE006		\$29.00
Rubber Seal Kit CANOPY008 to CANOPY011	CANOPYSPARE007		\$42.00
Rear Window Bolt Set for CANOPY003/ 004	CANOPYSPARE008		\$49.00
Edge Seal Kit for CANOPY006	CANOPYSPARE009		\$56.00
Edge Seal Kit for CANOPY005	CANOPYSPARE010		\$56.00
Edge Seal Kit for CANOPY001/ 002	CANOPYSPARE012		\$27.00
Replacement LED Brakelight (All Models)	CANOPYSPARE013		\$38.00
Sliding Window L/H for CANOPY001/ 002/ 005/ 006/ 007/ 009	CANOPYSPARE014		\$465.00
Sliding Window L/H for CANOPY003/ 004	CANOPYSPARE015		\$482.00
Sliding Window R/H for CANOPY003/ 004	CANOPYSPARE016		\$450.00
Sliding Window R/H for CANOPY001/ 002/ 005/ 006/ 007/ 009	CANOPYSPARE017		\$466.00
Rear Glass Rod Set for CANOPY001 to CANOPY007 & CANOPY009	CANOPYSPARE018		\$38.00
Rear Side Plate Lock Set for CANOPY010	CANOPYSPARE019		\$31.00
Rear Side Plate Lock Set for CANOPY009/ 011	CANOPYSPARE020		\$33.00
Sliding Window R/H for CANOPY008/ 010/ 011/ 012	CANOPYSPARE021		\$465.00
Sliding Window L/H for CANOPY008/ 010/ 011/ 012	CANOPYSPARE022		\$465.00
Rear Window Gas Strut for CANOPY011 (Pair)	CANOPYSPARE023		\$122.00
Rear Window Bolt Set for CANOPY001/ 002/ 005/ 006/ 007	CANOPYSPARE024		\$6.00
Rotary Lock for CANOPY008	CANOPYSPARE025		\$58.00
Rear Window Hinge Set for CANOPY001/ 002/ 005/ 006/ 007/ 009	CANOPYSPARE026		\$179.00
Rear Window Hinge Set for CANOPY008	CANOPYSPARE027		\$158.00
Rear Window Hinge Set for CANOPY010	CANOPYSPARE028		\$191.00
Rear Window Hinge Set for CANOPY011	CANOPYSPARE029		\$159.00
Rear Window Bolt Set Upper for CANOPY010	CANOPYSPARE031		\$11.00
Front Sliding Window for CANOPY001/ 005/ 006/ 007/ 008/ 010/ 014	CANOPYSPARE032		\$340.00
Rear Window Gas Strut for CANOPY010 (Pair)	CANOPYSPARE033		\$125.00
Rear Window Gas Strut for CANOPY008 (Pair)	CANOPYSPARE034		\$127.00
Rotary Lock Set for CANOPY010/ 011/ 012	CANOPYSPARE035		\$67.00
Mount Kit for CANOPY001	CANOPYSPARE036		\$158.00
Mount Kit for CANOPY002	CANOPYSPARE037		\$133.00
Mount Kit for CANOPY003	CANOPYSPARE038		\$154.00
Mount Kit for CANOPY004	CANOPYSPARE039		\$165.00
Mount Kit for CANOPY005	CANOPYSPARE040		\$165.00
Mount Kit for CANOPY006	CANOPYSPARE041		\$165.00
Mount Kit for CANOPY007	CANOPYSPARE042		\$165.00
Mount Kit for CANOPY008	CANOPYSPARE043		\$165.00
Mount Kit for CANOPY009	CANOPYSPARE044		\$254.00
Mount Kit for CANOPY010	CANOPYSPARE045		\$261.00
Mount Kit for CANOPY011	CANOPYSPARE046		\$218.00
Mount Kit for CANOPY012	CANOPYSPARE047		\$274.00



Spare Parts

PRODUCT DESCRIPTION	PART NO.	QTY Required	RETAIL ea Incl GST
Side Lift Up Window L/H for CANOPY001/ 002/ 005/ 006/ 007/ 009	CANOPYSPARE048		\$711.00
Side Lift Up Window R/H for CANOPY001/ 002/ 005/ 006/ 007/ 009	CANOPYSPARE049		\$711.00
Side Lift Up Window L/H for CANOPY003/ 004	CANOPYSPARE050		\$714.00
Side Lift Up Window R/H for CANOPY003/ 004	CANOPYSPARE051		\$714.00
Side Lift Up Window L/H for CANOPY008/ 010/ 011/ 012	CANOPYSPARE052		\$714.00
Side Lift Up Window R/H for CANOPY008/ 010/ 011/ 012	CANOPYSPARE053		\$714.00
Rubber Window Seal Kit for CANOPY001/ 002/ 003/ 004	CANOPYSPARE054		\$56.00
Window Rubber Seal Kit for CANOPY008	CANOPYSPARE055		\$52.00
Mounting Kit Seal for CANOPY010	CANOPYSPARE056		\$56.00
Window Rubber Seal Kit for CANOPY011	CANOPYSPARE057		\$52.00
Rear Window Bolt Set Lower Series 1	CANOPYSPARE058		\$8.00
Rear Window Bolt Set Lower for CANOPY010	CANOPYSPARE059		\$11.00
Ironman 4x4 Resin Logo Small	CANOPYSPARE060		\$20.00
Side Lift Up Window Handle for Series 1/ 2 (Set of 4)	CANOPYSPARE061		\$90.00
Side lift Up Window Handle for Series 3 (Set of 4)	CANOPYSPARE062		\$90.00
Rear Window Gas Strut for CANOPY009 (Pair)	CANOPYSPARE063		\$127.00
Front Sliding Window for CANOPY011/ 012	CANOPYSPARE064		\$393.00
Rear Window Lock & Key Set for CANOPY014/ 015	CANOPYSPARE066		\$129.00
Side Lift Up Window L/H for CANOPY014	CANOPYSPARE068		\$625.00
Side Lift Up Window R/H for CANOPY014	CANOPYSPARE069		\$714.00
Internal Light - Battery Operated	CANOPYSPARE070		\$54.00
Sliding Window L/H for CANOPY019/ 020	CANOPYSPARE071		\$465.00
Sliding Window R/H for CANOPY019/ 020	CANOPYSPARE072		\$465.00
Lift Up Window L/H for CANOPY019/ 020	CANOPYSPARE073		\$764.00
Lift Up Window R/H for CANOPY019/ 020	CANOPYSPARE074		\$764.00
Rear Door Key Set - Central Locking	CANOPYSPARE075		\$161.00
Rear Window Gas Strut for CANOPY014/ 015 (Pair)	CANOPYSPARE076		\$86.00
Side Lock Set for CANOPY014/ 015	CANOPYSPARE077		\$38.00
Rear Window Seal for CANOPY014/ 015/ 019/ 020	CANOPYSPARE078		\$42.00
Rear Window for CANOPY003	CANOPY003-WINDOW		\$657.00
Rear Window for CANOPY004	CANOPY004-WINDOW		\$607.00
Rear Window for CANOPY005	CANOPY005-WINDOW		\$600.00
Rear Window for CANOPY006	CANOPY006-WINDOW		\$600.00
Rear Window for CANOPY007	CANOPY007-WINDOW		\$484.00
Rear Window for CANOPY008	CANOPY008-WINDOW		\$450.00
Rear Window for CANOPY009	CANOPY009-WINDOW		\$757.00
Rear Window for CANOPY010	CANOPY010-WINDOW		\$750.00
Rear Window Assy for CANOPY010 - Central Locking	CANOPY010-CL WINDOW		\$754.00
Rear Window for CANOPY011	CANOPY011-WINDOW		\$693.00
Rear Window for CANOPY012	CANOPY012-WINDOW		\$714.00
Rear Window Assy for CANOPY014	CANOPY014-WINDOW		\$657.00
Rear Window Assy for CANOPY014 - Central Locking	CANOPY014-CL WINDOW		\$704.00
Rear Window Assy Suits CANOPY015	CANOPY015-WINDOW		\$640.00
Rear Window Assy for CANOPY015 - Central Locking	CANOPY015-CL WINDOW		\$729.00
Rear Window Assy Suits CANOPY017	CANOPY017-WINDOW		\$640.00
Rear Window Assy CANOPY019 - Central Locking	CANOPY019-CL WINDOW		\$782.00
Rear Window Assy CANOPY020 - Central Locking	CANOPY020-CL WINDOW		\$789.00
Use CANFIBRE054-Window	CANFIBRESPARE001		\$615.00
Use CANFIBRE050-Window	CANFIBRESPARE002		\$615.00
Lift Up Window L/H	CANFIBRESPARE006		\$714.00
Lift Up Window R/H	CANFIBRESPARE007		\$714.00
Front Sliding Window Complete	CANFIBRESPARE010		\$284.00
Rubber Seal Kit Bottom (All Models)	CANFIBRESPARE011		\$53.00
Rear Window Seal Kit (All)	CANFIBRESPARE012		\$526.00
Side Window Seal Kit (All)	CANFIBRESPARE013		\$24.00
Side Lift Up Window Gas Strut (All)	CANFIBRESPARE014		\$51.00
Interior LED Battery Light	CANFIBRESPARE015		\$51.00
Rear LED Brake Light	CANFIBRESPARE016		\$69.00

Spare Parts

PRODUCT DESCRIPTION	PART NO.	QTY Required	RETAIL ea Incl GST
Canopy Mount Kit (All)	CANFIBRESPARE019		\$51.00
Door Side Bracket & Striker Plate (All)	CANFIBRESPARE020		\$72.00
Rear Door Side Lock Set (All)	CANFIBRESPARE021		\$47.00
Rear Door Hinge Set (All)	CANFIBRESPARE022		\$40.00
Rear Window Gas Strut Brackets (LH / RH)	CANFIBRESPARE023		\$27.00
Side Window Rubber Grommet (Kit of 4)	CANFIBRESPARE024		\$27.00
Roof Rail (All Models)	CANFIBRESPARE025		\$147.00
Fibreglass Canopy Packing Box	CANFIBRESPARE026		\$216.00
Rear Window Gas Strut LH (All Models)	CANFIBRESPARE027		\$76.00
Rear Window Gas Strut RH (All Models)	CANFIBRESPARE028		\$76.00
Rear Door Sidelock RH	CANFIBRESPARE029		\$40.00
Rear Door Sidelock LH	CANFIBRESPARE030		\$40.00
Ironman 4x4 Logo for Fibreglass Canopies (All Models)	CANFIBRESPARE031		\$10.00
Rear Door Bottom Seal (All Models)	CANFIBRESPARE032		\$11.00
Rear Door Sidelock Set RH (NP300 Only)	CANFIBRESPARE033		\$40.00
Rear Door Sidelock Set LH (NP300 Only)	CANFIBRESPARE034		\$40.00
Rear Window Lock and Key Set (NP300 Only)	CANFIBRESPARE035		\$321.00
Side and Rear Window Handle and Key Set	CANFIBRESPARE036		\$418.00
Canopy Mount Kit (MQ-MR Triton)	CANFIBRESPARE037		\$49.00
Canopy Mount Kit (NP300)	CANFIBRESPARE038		\$49.00
Canopy Mount Kit (Hilux Revo)	CANFIBRESPARE039		\$49.00
Rear Window Strut for CANFIBRE054 (Includes Fibreglass Frame Black Painted)	CANFIBRE054-WINDOW		\$615.00
Rear Window Strut for CANFIBRE050 (Includes Fibreglass Frame Black Painted)	CANFIBRE050-WINDOW		\$615.00
Rear Window Strut for CANFIBRE051 (Includes Fibreglass Frame Black Painted)	CANFIBRE051-WINDOW		\$615.00
Rear Window Strut for CANFIBRE048 (Includes Fibreglass Frame Black Painted)	CANFIBRE048-WINDOW		\$615.00
Rear Window Strut for CANFIBRE057 (Includes Fibreglass Frame Black Painted)	CANFIBRE057-WINDOW		\$615.00
CANOPY / ROOF RACKS			
Cross Bar for Trade Style Fibreglass Canopies	IRRCROSSBAR001		\$250.00
Ironman 4x4 Logo for Cage Roof Racks	BBPART018		\$3.00
Wheel Clamp to suit 18/22 Cage Roof Racks	IRRWHEELCLAMP		\$91.00
INSTANT AWNINGS			
Awning L Mounting Brackets	IAWNINGSPARE001		\$22.00
Awning Hinge Joint for Poles	IAWNINGSPARE002		\$5.00
Awning Strap & Buckle	IAWNINGSPARE003		\$4.00
Awning Foot Piece with Rope	IAWNINGSPARE004		\$1.00
Awning End Pin	IAWNINGSPARE005		\$1.00
Awning Swivel Spacer	IAWNINGSPARE006		\$3.00
Awning Twist Lock	IAWNINGSPARE007		\$3.00
Awning Outer Pole 25mm - Tube Only	IAWNINGSPARE008		\$18.00
Awning Inner Pole 22mm - Tube Only	IAWNINGSPARE009		\$18.00
Replacement Awning Cover	IAWNINGSPARE010		\$53.00
Awning Square Rubber Catch	IAWNINGSPARE011		\$4.00
Awning 2.0 Horizontal External Pole	IAWNINGSPARE012		\$36.00
Awning 2.5 Horizontal External Pole	IAWNINGSPARE013		\$36.00
Plastic Clip for Awning Room/ Net	IAWNINGSPARE014		\$1.00
Horizontal Pole 2m	IAWNINGPART001		\$23.00
Horizontal Pole 2.5m	IAWNINGPART002		\$30.00
Vertical Pole	IAWNINGPART003		\$23.00
Rubber Stopper	IAWNINGPART004		\$3.00
Flex Joint	IAWNINGPART005		\$7.00
Light Strip and Dimmer Kit	IAWNINGPART006		\$56.00
'L' Mounting Bracket (1)	IAWNINGPART007		\$8.00
Guy Ropes and Peg Kit in Bag	IAWNINGPART008		\$19.00
Poles, Ropes, Pegs to suit Awning Room	IAWNINGPART009		\$34.00
Single Guy Ropes (Pair)	IAWNINGPART010		\$8.00



Spare Parts

PRODUCT DESCRIPTION	PART NO.	QTY Required	RETAIL ea Incl GST
ROOFTOP TENTS			
Travel Cover for Tent	IROOFTENTSPARE001		\$165.00
Mattress Cover	IROOFTENTSPARE002		\$53.00
Mounting Extrusions (x 2)	IROOFTENTSPARE003		\$65.00
Mounting Sliding Plate & Bolt	IROOFTENTSPARE004		\$4.00
Mounting Clamp	IROOFTENTSPARE005		\$6.00
Ladder Bracket (x 2)	IROOFTENTSPARE006		\$14.00
Bungee Cords (x 4)	IROOFTENTSPARE007		\$4.00
Window Rods (x 6)	IROOFTENTSPARE008		\$53.00
Straps for Tent Cover (x 2)	IROOFTENTSPARE010		\$7.00
Front Extrusion Bow	IROOFTENTSPARE011		\$20.00
Base Extrusion 1295mm	IROOFTENTSPARE012		\$29.00
Base Extrusion 1130mm	IROOFTENTSPARE013		\$27.00
Base Mid Extrusion Tongue/Groove (Pair)	IROOFTENTSPARE014		\$43.00
Tent Base Corner Piece	IROOFTENTSPARE015		\$4.00
Main Ladder	IROOFTENTSPARE016		\$211.00
Tent Fly Sheet	IROOFTENTSPARE017		\$172.00
Zip on Base For Cover	IROOFTENTSPARE018		\$15.00
Mattress	IROOFTENTSPARE019		\$197.00
Roof Top Tent Bow	IROOFTENTSPARE020		\$46.00
SWAGS			
Poles to Suit Single Dome Swag (Set of 3)	ISWAGPART001		\$77.00
Poles to Suit Double Dome Swag (Set of 3)	ISWAGPART002		\$92.00
Swag Single Mattress	ISWAGSPARE001		\$102.00
Swag Double Mattress	ISWAGSPARE002		\$128.00
FRIDGES			
Lid for 30, 40 & 50L Fridge	IFRIDGESPARE001		\$85.00
12V Lead for Fridges (All models)	IFRIDGESPARE002		\$28.00
Australian 240V Power Lead for Fridges (All models)	IFRIDGESPARE003		\$12.00
European Power Lead for Fridges (All models) - <i>While Stocks Last</i>	IFRIDGESPARE004		\$12.00
Internal Basket for 30L Fridge	IFRIDGESPARE005		\$36.00
Internal Basket for 40L Fridge	IFRIDGESPARE006		\$41.00
Internal Basket for 50L Fridge	IFRIDGESPARE007		\$48.00
Internal LED Light Suits all Fridges	IFRIDGESPARE008		\$7.00
Digital Control Panel for 30, 40 & 50L Fridge	IFRIDGESPARE009		\$34.00
Control PCB for 30, 40 & 50L Fridge	IFRIDGESPARE010		\$31.00
Compressor Control Suits all Fridges	IFRIDGESPARE011		\$438.00
Battery Protection for 30, 40 & 50L Fridge	IFRIDGESPARE012		\$6.00
DC Fan for 30, 40 & 50L Fridge	IFRIDGESPARE013		\$16.00
Digital Control Panel for 65L Fridge Dual Control	IFRIDGESPARE014		\$89.00
Digital Control Panel for 74L Fridge Single	IFRIDGESPARE015		\$89.00
DC Fan for 65 & 74L Fridge	IFRIDGESPARE016		\$19.00
Hinge for 65 & 74L Fridge (x 1)	IFRIDGESPARE017		\$6.00
American Power Lead for Fridges (All models)	IFRIDGESPARE018		\$12.00
Internal Basket Small for 65L Fridge	IFRIDGESPARE019		\$26.00
Internal Basket Large for 65L Fridge	IFRIDGESPARE020		\$33.00
Internal Basket Small for 74L Fridge	IFRIDGESPARE021		\$24.00
Internal Basket Large for 74L Fridge	IFRIDGESPARE022		\$34.00
Thermometer Probe for 30, 40 & 50L Fridge	IFRIDGESPARE023		\$6.00
Hinge & Spring for 30, 40 & 50L Fridge Lids	IFRIDGESPARE024		\$2.00
Thermometer Probe for 65 & 74L Fridge	IFRIDGESPARE025		\$4.00
Thermometer Probe for 65L Freezer Side	IFRIDGESPARE026		\$4.00
Digital Control Panel for 30, 40 & 50L Fridge (NEW)	IFRIDGESPARE027		\$51.00
Solenoid Valve for 65L Fridge	IFRIDGESPARE028		\$114.00

Spare Parts

PRODUCT DESCRIPTION	PART NO.	QTY Required	RETAIL ea Incl GST
SNORKELS			
Snorkel Mesh Inset Suits 3" and 3.5" Hat	ISNORKELSPARE001		\$29.00
Overflow Bottle Suits ISNORKELO20	ISNORKELSPARE002		\$54.00
3" Snorkel Hat	ISNORKEL 3" HAT		\$40.00
3.5" Snorkel Hat	ISNORKEL 3.5" HAT		\$40.00
4" Snorkel Hat	ISNORKEL 4" HAT		\$40.00
UBP UNDERBODY MOUNTING KITS			
Mounting Kit for UBPO19	UBPO19MK		\$38.00
Mounting Kit for UBPO19SC	UBPO19SCMK		\$38.00
Mounting Kit for UBPO33	UBPO33MK		\$38.00
Mounting Kit for UBPO41	UBPO41MK		\$38.00
Mounting Kit for UBPO47	UBPO47MK		\$38.00
Mounting Kit for UBPO47	UBPO48MK		\$38.00
Mounting Kit for UBPO50	UBPO50MK		\$38.00
Mounting Kit for UBPO51	UBPO51MK		\$38.00
Mounting Kit for UBPO54	UBPO54MK		\$38.00
Mounting Kit for UBPO55	UBPO55MK		\$38.00
Mounting Kit for UBPO56	UBPO56MK		\$38.00
Mounting Kit for UBPO57	UBPO57MK		\$38.00
Mounting Kit for UBPO201SY	UBP201SYMK		\$38.00
MISCELLANEOUS			
Air Compressor Replacement Hose	ICOMPRESSOR AIR LINE		\$25.00
Exhaust Generic Rubber Hanger (set 3) - 40-75mm	IEXH4075		\$13.75



Product Install Time Guide

ACCESSORIES AND SUSPENSION

Effective 1 May 2021



Average Installation Times (in hours)

INSTALLATION OF IRONMAN 4x4 PRODUCTS TO SUIT	TOYOTA HILUX MY21	FORD RANGER	ISUZU D-MAX	SUZUKI GJ JIMNY	TOYOTA LANDCRUISER 200
BULL BARS					
Commercial Bars	3.5	4	4.5	2.5	4
Commercial Deluxe Bars	3.5	4	4.5	N/A	4
Sensors/Cameras/Headlight Washers	0.5	1	0.25	N/A	1
Wire in Fog Lights using OEM Loom and Switches	0.5	N/A	0.5	N/A	0.5
Additional Wire in Fog Lights	1	1	1	N/A	1
WINCHES					
Note: Winch control box relocation may be required if the vehicle is fitted with additional accessories, radar and/or camera					
At Time of Installing Bull Bar	1.5	1.5	1.5	2	1.5 - 2
Fit to Existing Bull Bar	3	3	3	4	3
RECOVERY POINTS					
At Time of Installing Bar	0.5	0.5	0.5	0.5	0.5
Fit to Existing Bar	1	1	1	1	1
SIDE STEPS AND RAILS					
Side Steps	1.5	2	1.5	N/A	2
Side Steps and Rails	2.5	3	2.5	N/A	3
TOWBARS					
Towbar	2	2	2	N/A	N/A
Rear Protection Towbar	2	2	2	N/A	N/A
Rear Protection Towbar with Sensors	2.5	2.5	2.5	N/A	N/A
SUSPENSION					
Suspension Fitment	4	4	4	3	4.5
Upper Control Arm	2	2	2	N/A	2
Wheel Alignment	1	1	1	0.5	1
LIGHTS					
Light Bar or Driving Lights on Bull Bar	1.5	1	1	1.5	1
SNORKELS					
All Snorkels	3	3	3	2	3
LONG RANGE FUEL TANKS					
Tanks	4	3.5	3.5	N/A	N/A
UNDERBODY PROTECTION KITS					
UBP	0.75	0.75	1	N/A	0.75
CANOPIES					
ABS Plastic	2	2	3	N/A	N/A
Pinnacle Fibreglass	2	2	3	N/A	N/A
ROOF RACKS AND FEET					
Racks	1.5	1.5	1.5	1	2
DRAWER SYSTEMS					
Twin Drawers	1	1	1	N/A	2
Single Drawers	0.75	0.75	0.75	N/A	1
Wing Kit	1	1	1	N/A	1

Average Installation Times (in hours)

INSTALLATION OF IRONMAN 4X4 PRODUCTS TO SUIT	TOYOTA LANDCRUISER 79	MITSUBISHI TRITON MR	TOYOTA PRADO 150	NISSAN NP300 NAVARA	NISSAN GU PATROL
BULL BARS					
Commercial Bars	3	4.5	4.5	3	3
Commercial Deluxe Bars	3	4.5	4.5	3	3
Sensors/Cameras/Headlight Washers	N/A	0.5	0.15	N/A	N/A
Wire in Fog Lights using OEM Loom and Switches	N/A	0.5	0.15	0.5	N/A
Additional Wire in Fog Lights	1	1	1	1	1
WINCHES					
Note: Winch control box relocation may be required if the vehicle is fitted with additional accessories, radar and or camera					
At Time of Installing Bull Bar	1.5	1.5	1.5	1.5	1.5
Fit to Existing Bull Bar	3	3	3	3	3
RECOVERY POINTS					
At Time of Installing Bar	0.5	0.5	0.5	0.5	0.5
Fit to Existing Bar	1	1	1	3	1
SIDE STEPS AND RAILS					
Side Steps	1.5	2.5	1.5	2	1.5
Side Steps and Rails	2.5	2.5	2.5	3	2.5
TOWBARS					
Towbar	N/A	2	N/A	2	N/A
Rear Protection Towbar	N/A	2	N/A	2	N/A
Rear Protection Towbar with Sensors	N/A	3	N/A	2.5	N/A
SUSPENSION					
Suspension Fitment	3	4	4	3	2
Upper Control Arm	N/A	2	2	2	N/A
Wheel Alignment	0.5	1	1	1	0.5
LIGHTS					
Light Bar or Driving Lights on Bull Bar	1	1	2.5	1.5	1
SNORKELS					
All Snorkels	3	3	3	4	4
LONG RANGE FUEL TANKS					
Tanks	N/A	3.5	N/A	3.5	N/A
UNDERBODY PROTECTION KITS					
UBP	0.75	0.75	1	1.5	N/A
CANOPIES					
ABS Plastic	N/A	3	N/A	2	N/A
Pinnacle Fibreglass	N/A	3	N/A	2	N/A
ROOF RACKS AND FEET					
Racks	N/A	1.5	2	1.5	N/A
DRAWER SYSTEMS					
Twin Drawers	1	1	2	1	N/A
Single Drawers	0.75	0.75	1	0.7	N/A
Wing Kit	1	1	1	1	N/A





GVM Upgrades

CATALOGUE AND PRICE LIST

Effective 1 May 2021

GVM
IRONMAN UPGRAD



GVM Upgrades

PRODUCT DESCRIPTION

PART NO.

RETAIL
ea Incl GST

GVM UPGRADE TO SUIT FORD RANGER

PX MK III (NOT USA MODEL) 7/2018+ - (PAGE 48)

	Front Axle Rating	Rear Axle Rating	Gross Vehicle Mass (GVM)	Gross Combined Mass (GCM)	Towing Capacity (Braked)
Original Equipment (OE)	1480kg	1850kg	3200kg	6000kg	3500kg
Ironman 4x4	1500kg	2000kg	3500kg	6000kg	3500kg

These figures are presented as a guide only. Always refer to the owner's manual for load ratings specific to the vehicle

PRE REGISTRATION - 3500KG

Additional Payload

Foam Cell Shocks - Temporary Load	+300kg	FOR005BKFGVM	\$3259.87
Foam Cell Shocks - Permanent Load	+300kg	FOR005CKFGVM	\$3312.14
Foam Cell Pro Shocks - Temporary Load	+300kg	FOR005BKPGVM	\$3678.04
Foam Cell Pro Shocks - Permanent Load	+300kg	FOR005CKPGVM	\$3730.31

POST REGISTRATION - 3500KG

Additional Payload

Foam Cell Shocks - Temporary Load	+300kg	FOR005BKFGVM1	\$3259.87
Foam Cell Shocks - Permanent Load	+300kg	FOR005CKFGVM1	\$3312.15
Foam Cell Pro Shocks - Temporary Load	+300kg	FOR005BKPGVM1	\$3678.04
Foam Cell Pro Shocks - Permanent Load	+300kg	FOR005CKPGVM1	\$3730.31

Federal Approval CPA47511 - OE Approval No. 43280

- Only available through authorised Ironman 4x4 GVM upgrade installers
- Plus engineering sign off (Post Registration Only)
- Post Registration, State Approval - Vehicle must be inspected and approved by state authorised automotive engineer for issue of modification plate
- GVM orders must be submitted via the GVM Portal

GVM UPGRADE KIT CONTENTS

Shock Absorbers	Leaf Springs	Centre Bearing Spacer Kit	SSM Compliance Plate (pre reg. only)
Strut Shock Absorbers	U-Bolts	Greasable Shackles and Pins	GVM Stickers
Coil Springs	Polyurethane Spring Bushes	Tyre Placard	

PRODUCT DESCRIPTION

PART NO.

RETAIL
ea Incl GST

GVM UPGRADE TO SUIT FORD RANGER

PX MK II (NOT USA MODEL) 2015 TO 6/2018 - (PAGE 52)

	Front Axle Rating	Rear Axle Rating	Gross Vehicle Mass (GVM)	Gross Combined Mass (GCM)	Towing Capacity (Braked)
Original Equipment (OE)	1480kg	1850kg	3200kg	6000kg	3500kg
Ironman 4x4	1500kg	2000kg	3500kg	6000kg	3500kg

These figures are presented as a guide only. Always refer to the owner's manual for load ratings specific to the vehicle

POST REGISTRATION - 3500KG

Additional Payload

Foam Cell Shocks - Temporary Load	+300kg	FOR001BKFGVM1	\$3259.16
Foam Cell Shocks - Permanent Load	+300kg	FOR001CKFGVM1	\$3311.44
Foam Cell Pro Shocks - Temporary Load	+300kg	FOR001BKPGVM1	\$3677.34
Foam Cell Pro Shocks - Permanent Load	+300kg	FOR001CKPGVM1	\$3729.61

Federal Approval CPA47511 - OE Approval No. 43280

- Only available through authorised Ironman 4x4 GVM upgrade installers
- Plus engineering sign off (Post Registration Only)
- Post Registration, State Approval - Vehicle must be inspected and approved by state authorised automotive engineer for issue of modification plate
- GVM orders must be submitted via the GVM Portal

GVM UPGRADE KIT CONTENTS

Shock Absorbers	Leaf Springs	Centre Bearing Spacer Kit	GVM Stickers
Strut Shock Absorbers	U-Bolts	Greasable Shackles and Pins	
Coil Springs	Polyurethane Spring Bushes	Tyre Placard	

GVM UPGRADE TO SUIT FORD RANGER

T6 PX (NOT USA MODEL) 2011 TO 2015 - (PAGE 56)

	Front Axle Rating	Rear Axle Rating	Gross Vehicle Mass (GVM)	Gross Combined Mass (GCM)	Towing Capacity (Braked)
Original Equipment (OE)	1480kg	1850kg	3200kg	6000kg	3500kg
Ironman 4x4	1500kg	2000kg	3500kg	6000kg	3500kg

These figures are presented as a guide only. Always refer to the owner's manual for load ratings specific to the vehicle

POST REGISTRATION - 3500KG

Additional Payload

Foam Cell Shocks - Temporary Load	+300kg	FOR001BKFGVM1	\$3259.16
Foam Cell Shocks - Permanent Load	+300kg	FOR001CKFGVM1	\$3311.44
Foam Cell Pro Shocks - Temporary Load	+300kg	FOR001BKPGVM1	\$3677.34
Foam Cell Pro Shocks - Permanent Load	+300kg	FOR001CKPGVM1	\$3729.61

Federal Approval CPA47511 - OE Approval No. 43280

- Only available through authorised Ironman 4x4 GVM upgrade installers
- Plus engineering sign off (Post Registration Only)
- Post Registration, State Approval - Vehicle must be inspected and approved by state authorised automotive engineer for issue of modification plate
- GVM orders must be submitted via the GVM Portal

GVM UPGRADE KIT CONTENTS

Shock Absorbers	Leaf Springs	Centre Bearing Spacer Kit	GVM Stickers
Strut Shock Absorbers	U-Bolts	Greasable Shackles and Pins	
Coil Springs	Polyurethane Spring Bushes	Tyre Placard	

GVM Upgrades

PRODUCT DESCRIPTION

PART NO.

RETAIL
ea Incl GST

GVM UPGRADE TO SUIT HOLDEN COLORADO

RG 2016+ - (PAGE 75)

	Front Axle Rating	Rear Axle Rating	Gross Vehicle Mass (GVM)	Gross Combined Mass (GCM)	Towing Capacity (Braked)
Original Equipment (OE)	1450kg	1850kg	3150kg	6000kg	3500kg
Ironman 4x4	1500kg	2000kg	3500kg	6000kg	3500kg

These figures are presented as a guide only. Always refer to the owner's manual for load ratings specific to the vehicle

POST REGISTRATION - 3500KG

Additional Payload

Foam Cell - Temporary Load	up to 400kg	HOLD021CKF2GVM1	\$3312.15
Foam Cell - Permanent Load	up to 400kg	HOLD021DKF2GVM1	\$3312.15
Foam Cell Pro - Temporary Load	up to 400kg	HOLD021CKP2GVM1	\$3730.33
Foam Cell Pro - Permanent Load	up to 400kg	HOLD021DKP2GVM1	\$3730.33

Federal Approval - CPA50676 - OE Approval No. 49275

- Only available through authorised Ironman 4x4 GVM upgrade installers
- Plus engineering sign off (Post Registration Only)
- Post Registration, State Approval - Vehicle must be inspected and approved by state authorised automotive engineer for issue of modification plate
- GVM orders must be submitted via the GVM Portal

GVM UPGRADE KIT CONTENTS

Shock Absorbers	Leaf Springs	Greasable Shackles and Pins
Strut Shock Absorbers	U-Bolts	Tyre Placard
Coil Springs	Polyurethane Spring Bushes	GVM Stickers

GVM UPGRADE TO SUIT HOLDEN COLORADO

RG 2012 TO 2015 - (PAGE 78)

	Front Axle Rating	Rear Axle Rating	Gross Vehicle Mass (GVM)	Gross Combined Mass (GCM)	Towing Capacity (Braked)
Original Equipment (OE)	1300kg	1680kg	2900kg	5400kg - Petrol 5900kg - Diesel	2500kg - Petrol 3000kg - Diesel
Ironman 4x4	1550kg	1950kg	3500kg	5400kg - Petrol 5900kg - Diesel	2500kg - Petrol 3000kg - Diesel

These figures are presented as a guide only. Always refer to the owner's manual for load ratings specific to the vehicle

POST REGISTRATION - 3500KG

Additional Payload

Foam Cell - Temporary Load	up to 600kg	HOLD021CKFGVM1	\$3312.15
Foam Cell - Permanent Load	up to 600kg	HOLD021DKFGVM1	\$3312.15
Foam Cell Pro - Temporary Load	up to 600kg	HOLD021CKPGVM1	\$3730.33
Foam Cell Pro - Permanent Load	up to 600kg	HOLD021DKPGVM1	\$3730.33

Federal Approval - CPA50676 - OE Approval No. 43669

- Only available through authorised Ironman 4x4 GVM upgrade installers
- Plus engineering sign off (Post Registration Only)
- Post Registration, State Approval - Vehicle must be inspected and approved by state authorised automotive engineer for issue of modification plate
- GVM orders must be submitted via the GVM Portal

GVM UPGRADE KIT CONTENTS

Shock Absorbers	Leaf Springs	Greasable Shackles and Pins
Strut Shock Absorbers	U-Bolts	Tyre Placard
Coil Springs	Polyurethane Spring Bushes	GVM Stickers



GVM UPGRADE TO SUIT ISUZU D-MAX

MY20+ - (PAGE 91)

	Front Axle Rating	Rear Axle Rating	Gross Vehicle Mass (GVM)	Gross Combined Mass (GCM)	Towing Capacity (Braked)
Original Equipment (OE)	1450kg	1910kg	3100kg	3500kg	5950kg
Ironman 4x4	1500kg	2000kg	3500kg	3500kg	5950kg

These figures are presented as a guide only. Always refer to the owner's manual for load ratings specific to the vehicle

PRE REGISTRATION - 3500KG

Additional Payload

Foam Cell - Temporary Load	up to 500kg	HOLD021CKF3GVM	\$3312.15
Foam Cell - Permanent Load	up to 500kg	HOLD021DKF3GVM	\$3312.15
Foam Cell Pro - Temporary Load	up to 500kg	HOLD021CKP3GVM	\$3730.33
Foam Cell Pro - Permanent Load	up to 500kg	HOLD021DKP3GVM	\$3730.33

POST REGISTRATION - 3500KG

Additional Payload

Foam Cell - Temporary Load	up to 500kg	HOLD021CKF3GVM1	\$3312.15
Foam Cell - Permanent Load	up to 500kg	HOLD021DKF3GVM1	\$3312.15
Foam Cell Pro - Temporary Load	up to 500kg	HOLD021CKP3GVM1	\$3730.33
Foam Cell Pro - Permanent Load	up to 500kg	HOLD021DKP3GVM1	\$3730.33

Federal Approval CPA51296 - OE Approval No. 50736

- Only available through authorised Ironman 4x4 GVM upgrade installers
- Plus engineering sign off (Post Registration Only)
- Post Registration, State Approval - Vehicle must be inspected and approved by state authorised automotive engineer for issue of modification plate
- GVM orders must be submitted via the GVM Portal

GVM UPGRADE KIT CONTENTS

Shock Absorbers	Leaf Springs	Greasable Shackles and Pins	SSM Compliance Plate (pre reg. only)
Strut Shock Absorbers	U-Bolts	Brake Hose Extension Bracket	GVM Stickers
Coil Springs	Polyurethane Spring Bushes	Tyre Placard	

GVM Upgrades

PRODUCT DESCRIPTION

PART NO.

RETAIL
ea Incl GST

GVM UPGRADE TO SUIT ISUZU D-MAX

2012 TO 7/2019 - (PAGE 94 & 97)

	Front Axle Rating	Rear Axle Rating	Gross Vehicle Mass (GVM)	Gross Combined Mass (GCM)	Towing Capacity (Braked)
Original Equipment (OE)	1350kg	1870kg	2950kg - 3050kg	5950kg	3500kg
Ironman 4x4	1500kg	2000kg	3500kg	5950kg	3500kg

These figures are presented as a guide only. Always refer to the owner's manual for load ratings specific to the vehicle

POST REGISTRATION - 3500KG

Additional Payload

Foam Cell - Temporary Load	up to 550kg	HOLD021CKF1GVM1	\$3312.15
Foam Cell - Permanent Load	up to 550kg	HOLD021DKF1GVM1	\$3312.15
Foam Cell Pro - Temporary Load	up to 550kg	HOLD021CKP1GVM1	\$3730.33
Foam Cell Pro - Permanent Load	up to 550kg	HOLD021DKP1GVM1	\$3730.33

Federal Approval CPA49748 - OE Approval No. 43971

- Only available through authorised Ironman 4x4 GVM upgrade installers
- Plus engineering sign off (Post Registration Only)
- Post Registration, State Approval - Vehicle must be inspected and approved by state authorised automotive engineer for issue of modification plate
- GVM orders must be submitted via the GVM Portal

GVM UPGRADE KIT CONTENTS

Shock Absorbers	Leaf Springs	Greasable Shackles and Pins	GVM Stickers
Strut Shock Absorbers	U-Bolts	Brake Hose Extension Bracket	
Coil Springs	Polyurethane Spring Bushes	Tyre Placard	

GVM UPGRADE TO SUIT MAZDA BT50

6/2020 - (PAGE 140)

	Front Axle Rating	Rear Axle Rating	Gross Vehicle Mass (GVM)	Gross Combined Mass (GCM)	Towing Capacity (Braked)
Original Equipment (OE)	1450kg	1910kg	3100kg	3500kg	5950kg
Ironman 4x4	1500kg	2000kg	3500kg	3500kg	5950kg

These figures are presented as a guide only. Always refer to the owner's manual for load ratings specific to the vehicle

PRE REGISTRATION - 3500KG

Additional Payload

Foam Cell - Temporary Load	up to 500kg	HOLD021CKF3GVM	\$3312.15
Foam Cell - Permanent Load	up to 500kg	HOLD021DKF3GVM	\$3312.15
Foam Cell Pro - Temporary Load	up to 500kg	HOLD021CKP3GVM	\$3730.33
Foam Cell Pro - Permanent Load	up to 500kg	HOLD021DKP3GVM	\$3730.33

POST REGISTRATION - 3500KG

Additional Payload

Foam Cell - Temporary Load	up to 500kg	HOLD021CKF3GVM1	\$3312.15
Foam Cell - Permanent Load	up to 500kg	HOLD021DKF3GVM1	\$3312.15
Foam Cell Pro - Temporary Load	up to 500kg	HOLD021CKP3GVM1	\$3730.33
Foam Cell Pro - Permanent Load	up to 500kg	HOLD021DKP3GVM1	\$3730.33

Federal Approval 51465 - OE Approval No. 50871

- Only available through authorised Ironman 4x4 GVM upgrade installers
- Plus engineering sign off (Post Registration Only)
- Post Registration, State Approval - Vehicle must be inspected and approved by state authorised automotive engineer for issue of modification plate
- GVM orders must be submitted via the GVM Portal

GVM UPGRADE KIT CONTENTS

Shock Absorbers	Leaf Springs	Greasable Shackles and Pins	SSM Compliance Plate (pre reg. only)
Strut Shock Absorbers	U-Bolts	Brake Hose Relocation Kit	GVM Stickers
Coil Springs	Polyurethane Spring Bushes	Tyre Placard	

GVM Upgrades

PRODUCT DESCRIPTION

PART NO.

RETAIL
ea Incl GST

GVM UPGRADE TO SUIT SUZUKI JIMNY

GJ 2018+ - (PAGE 243)

	Front Axle Rating	Rear Axle Rating	Gross Vehicle Mass (GVM)	Gross Combined Mass (GCM)	Towing Capacity (Braked)
Original Equipment (OE)	680kg	880kg	1435kg	2735kg	1300kg
Ironman 4x4	800kg	1100kg	1785kg	2735kg	1300kg

These figures are presented as a guide only. Always refer to the owner's manual for load ratings specific to the vehicle

PRE REGISTRATION - 1785KG

Additional Payload

Nitro Gas - Temporary Load	up to 350kg	SUZ010BKGGVM	\$2475.80
Nitro Gas - Permanent Load	up to 350kg	SUZ010CKGGVM	\$2475.80

POST REGISTRATION - 1785KG

Additional Payload

Nitro Gas - Temporary Load	up to 350kg	SUZ010BKGGVM1	\$2475.80
Nitro Gas - Permanent Load	up to 350kg	SUZ010CKGGVM1	\$2475.80

Federal Approval CPA50688 - OE Approval No. 49434

- Only available through authorised Ironman 4x4 GVM upgrade installers
- Plus engineering sign off (Post Registration Only)
- Post Registration, State Approval - Vehicle must be inspected and approved by state authorised automotive engineer for issue of modification plate
- GVM orders must be submitted via the GVM Portal

GVM UPGRADE KIT CONTENTS

Shock Absorbers	Offset Bush Kit Rubber	Tyre Placard
Coil Springs	Extended Brake Hose	SSM Compliance Plate (pre reg. only)
Front Crossmember Drop Brackets	Extended Headlight Sensor Bracket	GVM Stickers

GVM UPGRADE TO SUIT TOYOTA HILUX

2015+ - (PAGE 268 & 272)

	Front Axle Rating	Rear Axle Rating	Gross Vehicle Mass (GVM)	Gross Combined Mass (GCM)	Towing Capacity (Braked)
Original Equipment (OE)	1450kg	1700kg	3050kg	5850kg	3500kg
Ironman 4x4 (3500kg)	1510kg	2000kg	3500kg	5850kg	3500kg
Ironman 4x4 (3510kg)	1510kg	2000kg	3510kg	5850kg	3500kg

These figures are presented as a guide only. Always refer to the owner's manual for load ratings specific to the vehicle

PRE REGISTRATION - 3500KG

Additional Payload

Foam Cell - Temporary Load	up to 500kg	TOY077CKF1GVM	\$3220.81
Foam Cell - Permanent Load	up to 500kg	TOY077DKF1GVM	\$3220.81
Foam Cell Pro - Temporary Load	up to 500kg	TOY077CKP1GVM	\$3769.66
Foam Cell Pro - Permanent Load	up to 500kg	TOY077DKP1GVM	\$3769.66

POST REGISTRATION - 3500KG

Additional Payload

Foam Cell - Temporary Load	up to 500kg	TOY077CKF1GVM1	\$3220.81
Foam Cell - Permanent Load	up to 500kg	TOY077DKF1GVM1	\$3220.81
Foam Cell Pro - Temporary Load	up to 500kg	TOY077CKP1GVM1	\$3769.66
Foam Cell Pro - Permanent Load	up to 500kg	TOY077DKP1GVM1	\$3769.66

Federal Approval CPA50749 - OE Approval No. 47341

PRE REGISTRATION - 3510KG

Additional Payload

Foam Cell - Temporary Load	up to 510kg	TOY077CKFGVM	\$3312.14
Foam Cell - Permanent Load	up to 510kg	TOY077DKFGVM	\$3312.14
Foam Cell Pro - Temporary Load	up to 510kg	TOY077CKPGVM	\$3860.99
Foam Cell Pro - Permanent Load	up to 510kg	TOY077DKPGVM	\$3860.99

POST REGISTRATION - 3510KG

Additional Payload

Foam Cell - Temporary Load	up to 510kg	TOY077CKFGVM1	\$3312.14
Foam Cell - Permanent Load	up to 510kg	TOY077DKFGVM1	\$3312.14
Foam Cell Pro - Temporary Load	up to 510kg	TOY077CKPGVM1	\$3860.99
Foam Cell Pro - Permanent Load	up to 510kg	TOY077DKPGVM1	\$3860.99

Federal Approval CPA48310 (3510kg GVM) - OE Approval No. 47341

Federal Approval CPA50749 (3500kg GVM) - OE Approval No. 47341

- Only available through authorised Ironman 4x4 GVM upgrade installers
- Plus engineering sign off (Post Registration Only)
- Post Registration, State Approval - Vehicle must be inspected and approved by state authorised automotive engineer for issue of modification plate
- GVM orders must be submitted via the GVM Portal

GVM UPGRADE KIT CONTENTS

Shock Absorbers	Leaf Springs	Greasable Shackles	Tyre Placard
Strut Shock Absorbers	U-Bolts	Non-Greasable Pin Kit	SSM Compliance Plate (pre reg. only)
Coil Springs	Polyurethane Spring Bushes	Cat. 6 Side Indicators (3510kg only)	GVM Stickers

GVM Upgrades

PRODUCT DESCRIPTION

PART NO.

RETAIL
ea Incl GST

GVM UPGRADE TO SUIT TOYOTA HILUX

2005 TO 2015 - (PAGE 275)

	Front Axle Rating	Rear Axle Rating	Gross Vehicle Mass (GVM)	Gross Combined Mass (GCM)	Towing Capacity (Braked)
Original Equipment (OE)	1240kg - 1340kg ¹	1520kg - 1600kg ²	2850kg	4600kg - 4750kg ³	3200kg
Ironman 4x4	1540kg	1810kg	3350kg	4600kg - 4750kg ³	3200kg

¹ Front axle updated 4 times

² Single Cab and Double Cab 1600kg, Extra Cab 1520kg

³ 1GR-FE 4750kg, 2TR-FE 4600kg

These figures are presented as a guide only. Always refer to the owner's manual for load ratings specific to the vehicle

POST REGISTRATION - 3350KG

Additional Payload

Foam Cell - Temporary Load	up to 500kg	TOY057CKFGVM1	\$3138.94
Foam Cell - Permanent Load	up to 500kg	TOY057DKFGVM1	\$3138.94
Foam Cell Pro - Temporary Load	up to 500kg	TOY057CKPGVM1	\$3648.59
Foam Cell Pro - Permanent Load	up to 500kg	TOY057DKPGVM1	\$3648.59

Federal Approval - CPA44780 - OE Approval No. 33886

- Only available through authorised Ironman 4x4 GVM upgrade installers
- Plus engineering sign off (Post Registration Only)
- Post Registration, State Approval - Vehicle must be inspected and approved by state authorised automotive engineer for issue of modification plate
- GVM orders must be submitted via the GVM Portal

GVM UPGRADE KIT CONTENTS

Shock Absorbers	Leaf Springs	Greasable Shackles and Pins
Strut Shock Absorbers	U-Bolts	Tyre Placard
Coil Springs	Polyurethane Spring Bushes	GVM Stickers

GVM UPGRADE TO SUIT TOYOTA LANDCRUISER

200 SERIES MC / NA 2007+ - (PAGE 284)

	Front Axle Rating	Rear Axle Rating	Gross Vehicle Mass (GVM)	Gross Combined Mass (GCM)	Towing Capacity (Braked)
Original Equipment (OE)	1630kg ¹ 1700kg ¹	1950kg	3300kg ² 3350kg ²	6850kg	3500kg 3550kg
Ironman 4x4	1800kg	2250kg	3580kg 4000kg	6850kg	3500kg 3550kg

¹ Front axle upgraded January 2012

² GVM upgraded January 2012

These figures are presented as a guide only. Always refer to the owner's manual for load ratings specific to the vehicle

PRE REGISTRATION - 4000KG

Additional Payload

Foam Cell Pro - MC Compliance	up to 700kg	TOY063CKPGVM-MC	\$2859.28
Foam Cell Pro - NA Compliance	up to 700kg	TOY063CKPGVM-NB1	\$3040.78

Federal Approval - (MC) CPA50517 and (NB1) CPA50503 - OE Approval No. MC-38469 and NA-43656

POST REGISTRATION - 4000KG

Additional Payload

Foam Cell Pro - MC Compliance	up to 700kg	TOY063CKPGVM1-MC	\$2859.28
Foam Cell Pro - NA Compliance	up to 700kg	TOY063CKPGVM1-NB1	\$3040.78

Federal Approval - (MC) CPA50517 and (NB1) CPA50503 - OE Approval No. MC-38469 and NA-43656

POST REGISTRATION - 3580KG

Additional Payload

Foam Cell Pro - Temporary Load	up to 280kg	TOY063BKPGVM1	\$2599.35
--------------------------------	-------------	----------------------	-----------

• Only available through authorised Ironman 4x4 GVM upgrade installers

• Plus engineering sign off (Post Registration Only)

• Post Registration, State Approval - Vehicle must be inspected and approved by state authorised automotive engineer for issue of modification plate

• Upgrades NA vehicles to NB1 category (fitment of Cat. 6 side indicator lamps required)

• GVM orders must be submitted via the GVM Portal

GVM UPGRADE KIT CONTENTS

Shock Absorbers	Coil Springs	Tyre Placard	GVM Stickers
Strut Shock Absorbers	Cat. 6 Side Indicators (NA-NB1 vehicles only)	SSM Compliance Plate (pre reg. only)	

GVM Upgrades

PRODUCT DESCRIPTION

PART NO.

RETAIL
ea Incl GST

GVM UPGRADE TO SUIT TOYOTA LANDCRUISER

79 SERIES SINGLE CAB 2007+ - (PAGE 297)

	Front Axle Rating	Rear Axle Rating	Gross Vehicle Mass (GVM)	Gross Combined Mass (GCM)	Towing Capacity (Braked)
Original Equipment (OE)	1480kg	2300kg	3400kg	6900kg	3500kg
Ironman 4x4	1550kg	2800kg	3900kg	6900kg	3500kg

These figures are presented as a guide only. Always refer to the owner's manual for load ratings specific to the vehicle

PRE REGISTRATION - 3900KG

Additional Payload

Foam Cell - Temporary Load	up to 600kg	TOY047CKFGVM	\$3648.59
Foam Cell - Frequent Load	up to 600kg	TOY047DKFGVM	\$3727.00
Foam Cell - Permanent Load	up to 600kg	TOY047EKFGVM	\$3753.13
Foam Cell Pro - Temporary Load	up to 600kg	TOY047CKPGVM	\$3791.03
Foam Cell Pro - Frequent Load	up to 600kg	TOY047DKPGVM	\$3869.44
Foam Cell Pro - Permanent Load	up to 600kg	TOY047EKPGVM	\$3895.58

POST REGISTRATION - 3900KG

Additional Payload

Foam Cell - Temporary Load	up to 600kg	TOY047CKFGVM1	\$3648.59
Foam Cell - Frequent Load	up to 600kg	TOY047DKFGVM1	\$3727.00
Foam Cell - Permanent Load	up to 600kg	TOY047EKFGVM1	\$3753.13
Foam Cell Pro - Temporary Load	up to 600kg	TOY047CKPGVM1	\$3791.03
Foam Cell Pro - Frequent Load	up to 600kg	TOY047DKPGVM1	\$3869.44
Foam Cell Pro - Permanent Load	up to 600kg	TOY047EKPGVM1	\$3895.58

Federal Approval - CPA45466 - OE Approval No. 03477

- Only available through authorised Ironman 4x4 GVM upgrade installers
- Plus engineering sign off (Post Registration Only)
- Post Registration, State Approval - Vehicle must be inspected and approved by state authorised automotive engineer for issue of modification plate
- GVM orders must be submitted via the GVM Portal

GVM UPGRADE KIT CONTENTS

Shock Absorbers	U-Bolts	Extended Brake Hose	Tyre Placard
Coil Springs	Polyurethane Spring Bushes	C Washer to Suit Brake Hose	SSM Compliance Plate (pre reg. only)
Leaf Springs	Greasable Shackles and Pins	Cat. 6 Side Indicators	GVM Stickers

GVM UPGRADE TO SUIT TOYOTA LANDCRUISER

79 SERIES DUAL CAB 2012+ - (PAGE 300)

	Front Axle Rating	Rear Axle Rating	Gross Vehicle Mass (GVM)	Gross Combined Mass (GCM)	Towing Capacity (Braked)
Original Equipment (OE)	1480kg	2300kg	3300kg	6800kg	3500kg
Ironman 4x4	1550kg	2800kg	3900kg	6800kg	3500kg

These figures are presented as a guide only. Always refer to the owner's manual for load ratings specific to the vehicle

PRE REGISTRATION - 3900KG

Additional Payload

Foam Cell - Temporary Load	up to 600kg	TOY047CKFGVM	\$3648.59
Foam Cell - Frequent Load	up to 600kg	TOY047DKFGVM	\$3727.00
Foam Cell - Permanent Load	up to 600kg	TOY047EKFGVM	\$3753.13
Foam Cell Pro - Temporary Load	up to 600kg	TOY047CKPGVM	\$3791.03
Foam Cell Pro - Frequent Load	up to 600kg	TOY047DKPGVM	\$3869.44
Foam Cell Pro - Permanent Load	up to 600kg	TOY047EKPGVM	\$3895.58

POST REGISTRATION - 3900KG

Additional Payload

Foam Cell - Temporary Load	up to 600kg	TOY047CKFGVM1	\$3648.59
Foam Cell - Frequent Load	up to 600kg	TOY047DKFGVM1	\$3727.00
Foam Cell - Permanent Load	up to 600kg	TOY047EKFGVM1	\$3753.13
Foam Cell Pro - Temporary Load	up to 600kg	TOY047CKPGVM1	\$3791.03
Foam Cell Pro - Frequent Load	up to 600kg	TOY047DKPGVM1	\$3869.44
Foam Cell Pro - Permanent Load	up to 600kg	TOY047EKPGVM1	\$3895.58

Federal Approval - CPA45466 - OE Approval No. 03477

- Only available through authorised Ironman 4x4 GVM upgrade installers
- Plus engineering sign off (Post Registration Only)
- Post Registration, State Approval - Vehicle must be inspected and approved by state authorised automotive engineer for issue of modification plate
- GVM orders must be submitted via the GVM Portal

GVM UPGRADE KIT CONTENTS

Shock Absorbers	U-Bolts	Extended Brake Hose	Tyre Placard
Coil Springs	Polyurethane Spring Bushes	C Washer to Suit Brake Hose	SSM Compliance Plate (pre reg. only)
Leaf Springs	Greasable Shackles and Pins	Cat. 6 Side Indicators	GVM Stickers

GVM Upgrades

PRODUCT DESCRIPTION

PART NO.

RETAIL
ea Incl GST

GVM UPGRADE TO SUIT TOYOTA LANDCRUISER

78 SERIES TROOP CARRIER 2007+ - (PAGE 304)

	Front Axle Rating	Rear Axle Rating	Gross Vehicle Mass (GVM)	Gross Combined Mass (GCM)	Towing Capacity (Braked)
Original Equipment (OE)	1480kg	2300kg	3300kg	6800kg	3500kg
Ironman 4x4	1550kg	2800kg	3900kg	6800kg	3500kg

These figures are presented as a guide only. Always refer to the owner's manual for load ratings specific to the vehicle

PRE REGISTRATION - 3900KG

Additional Payload

Foam Cell - Temporary Load	up to 600kg	TOY047CKFGVM	\$3648.59
Foam Cell - Frequent Load	up to 600kg	TOY047DKFGVM	\$3727.00
Foam Cell - Permanent Load	up to 600kg	TOY047EKFGVM	\$3753.13
Foam Cell Pro - Temporary Load	up to 600kg	TOY047CKPGVM	\$3791.03
Foam Cell Pro - Frequent Load	up to 600kg	TOY047DKPGVM	\$3869.44
Foam Cell Pro - Permanent Load	up to 600kg	TOY047EKPGVM	\$3895.58

POST REGISTRATION - 3900KG

Additional Payload

Foam Cell - Temporary Load	up to 600kg	TOY047CKFGVM1	\$3648.59
Foam Cell - Frequent Load	up to 600kg	TOY047DKFGVM1	\$3727.00
Foam Cell - Permanent Load	up to 600kg	TOY047EKFGVM1	\$3753.13
Foam Cell Pro - Temporary Load	up to 600kg	TOY047CKPGVM1	\$3791.03
Foam Cell Pro - Frequent Load	up to 600kg	TOY047DKPGVM1	\$3869.44
Foam Cell Pro - Permanent Load	up to 600kg	TOY047EKPGVM1	\$3895.58

Federal Approval - CPA45466 - OE Approval No. 03477

- Only available through authorised Ironman 4x4 GVM upgrade installers
- Plus engineering sign off (Post Registration Only)
- Post Registration, State Approval - Vehicle must be inspected and approved by state authorised automotive engineer for issue of modification plate
- GVM orders must be submitted via the GVM Portal

GVM UPGRADE KIT CONTENTS

Shock Absorbers	U-Bolts	Extended Brake Hose	Tyre Placard
Coil Springs	Polyurethane Spring Bushes	C Washer to Suit Brake Hose	SSM Compliance Plate (pre reg. only)
Leaf Springs	Greasable Shackles and Pins	Cat. 6 Side Indicators	GVM Stickers

Suspension Selection and Information

Effective 1 May 2021



Understanding Load

Suspension is not something you often see when you first look at a vehicle. But when you need it, suspension can be the single most important upgrade you make. Original equipment suspension is set up to support your vehicle for on-road conditions with a reasonable amount of weight.

When you start to add vehicle accessories, attach a trailer or caravan and increase your load, the way the suspension handles the load changes. Couple that with uneven surfaces and off-road conditions, the OEM suspension can no longer take the additional strain.

LOAD DISTRIBUTION



1
Load placed over the front half of the vehicle determines front spring selection
Ensure total weight does not exceed manufacturers axle load limit



2
Load placed over the rear half of the vehicle determines rear spring selection
Ensure total weight does not exceed manufacturers axle load limit



3
 $1 + 2 =$ Total weight of vehicle
Ensure total weight does not exceed manufacturers GVM (gross vehicle mass)

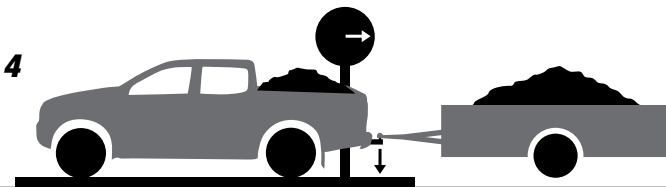

4
Vehicle with trailer connected minus total weight of vehicle = Ball weight
Ensure total weight of vehicle including ball weight does not exceed manufacturers GVM

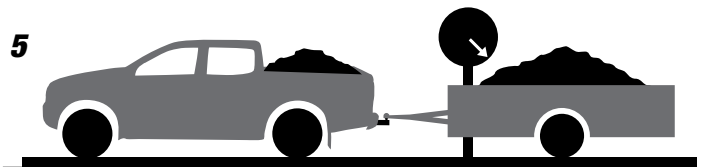

5
Total weight of vehicle plus trailer weight = GCM (gross combined mass)
Ensure total weight of vehicle and trailer does not exceed manufacturers GCM

Please note: Not all springs are available in green and some may be supplied in yellow. Please check before ordering.



Determining Load

STEP ONE LOAD?

When your load changes, so should your springs.

Any heavy accessories or towing load added to your vehicle, changes the handling and overall safety when driving. The vehicle's springs must be matched to the load for optimum ride height and body control. Ironman 4x4 offer a range of springs to match the additional loads whether they are constant or temporary.

When you start kitting out your vehicle, take into consideration the kerb weight and how much load you are adding, this will change what level of strength you need. Remember, you cannot exceed your GVM, but you might be able to upgrade it. (See page 363 for GVM upgrade information)

Ironman 4x4 offer a range of springs matched to cater for every load scenario. To identify your spring type, start by finding your kerb weight and add your load, permanent and temporary. How much load have you added to your vehicle?

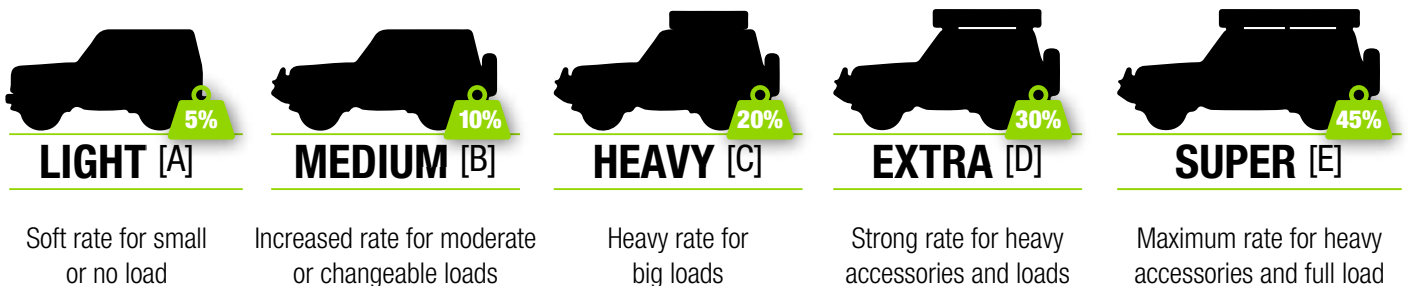

PART NUMBER SUFFIX S - Standard Height (eg. TOY063S)

Available for selected applications to provide enhanced performance at original vehicle manufacturers ride height.

PART NUMBER SUFFIX A - Light (eg. TOY047A)

Suitable for zero to light load applications, higher priority toward - Comfort with minimal increased ride height.

PART NUMBER SUFFIX B - Medium (eg. TOY047B)

Suitable for use in zero to medium load applications, ideal for moderately accessorised vehicles or occasional load.

PART NUMBER SUFFIX C - Heavy (eg. TOY047C)

Suitable for vehicles with permanent heavy accessories, higher priority towards load support, provides more control and firmer suspension.

PART NUMBER SUFFIX D - Extra Heavy (eg. TOY047D)

Suited only to vehicles with permanent heavy accessories combined with heavy additional load.

PART NUMBER SUFFIX E - Super Heavy (eg. TOY047E)

Maximum support for extra heavy loads typically commercial or mining use vehicles.

All lift heights quoted within this catalogue are general estimates only, relative to new vehicle ride height. Suggested lifts are based upon the lighter of the recommended additional load. The position of added weight can affect the result.

Understanding Terrain

STEP TWO TERRAIN?

The terrain you travel most, determines what type of shock absorber is right for you! Forces generated by a loaded vehicle in rough terrain versus a lightly loaded vehicle in smooth terrain differ greatly and can be considerably higher.

Creating safe and appropriate dynamic handling at higher than original weights requires careful consideration. The range of Ironman 4x4 shock absorbers are designed to cover all terrains and possess the correct amount of damping resistance to provide a safe and comfortable ride.

Easy Terrain



NITROGAS

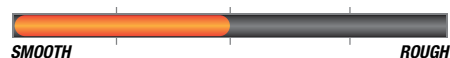

Adventurous Terrain



FOAMCELL



Demanding Terrain



FOAMCELLPRE

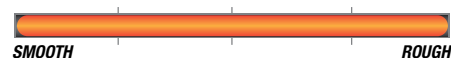

Nitro Gas

The Nitro Gas shock is the best value for affordable performance in all common conditions.

Highly versatile, the shock is a big step up above OEM suspension in performance and control.

- 35mm piston
- 54mm body
- 16mm piston rod
- Twin tube construction
- Nitrogen gas pressurised

Foam Cell

The Foam Cell shock will enhance your off-road durability and performance while still maintaining excellent on-road characteristics.

Excels in off-road conditions where heat build-up is a concern, the Foam Cell shock is larger in size and holds more oil, providing a better dissipation of heat and longer lasting performance in all terrains.

- 40mm piston
- 60mm body
- 18mm piston rod
- Twin tube construction
- Foam cell technology

Foam Cell Pro

Foam Cell Pro shock, the premium shock, built to handle anything.

Originally designed to meet the demands of the armoured vehicle industry where reliability and durability are critical.

Foam Cell Pro is the ultimate shock when the going gets tough. Thicker and stronger than any other shock on the market, it's well suited to trades, fleet and serious off-roaders.

- 45mm piston
- 65-72mm body
- 20mm piston rod
- 3mm wall thickness
- Twin tube construction
- Foam cell technology

Understanding Valving

STEP THREE

RIDE STYLE?

Your preferred ride style is important to know when selecting the level of valving resistance in your shock absorbers. Ironman 4x4 shock absorbers adapt to the velocity of the compression and rebound stroke which provides the right amount of control to suit your driving style.

Comfort Valving

GRC FEC FEC^{PRO}

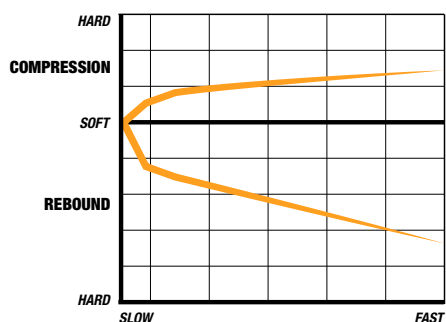

Soft Ride - Lightly Accessorised

The comfort range delivers smooth handling and less harshness for everyday use. Best suited to lighter vehicles without load, the shocks prioritise a soft comfortable ride, above all else.

Performance Valving

GR FE FE^{PRO}

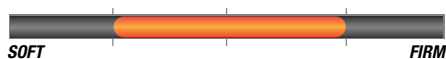
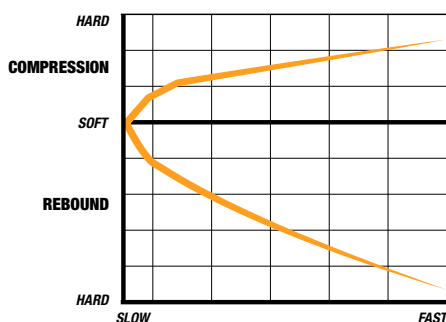

Versatile Ride - Moderately Accessorised

The performance range adapts to a wide range of driving styles. Best suited to moderately loaded vehicles with some accessories, the shocks provide a balanced comfortable ride with more control.

Professional Valving

GRP FEP FEP^{PRO}

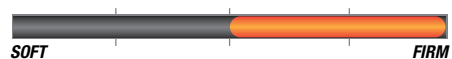
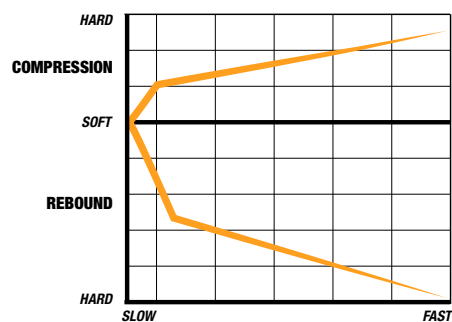

Strong Controlled Ride - Heavily Accessorised

The professional range controls body roll and reduces pitching while driving over all terrains. Best suited to heavily loaded vehicles with a higher centre of gravity, the shocks focus on maximising control and stability.



Understanding GVM Upgrades

GVM UPGRADE REQUIRED?

If loads exceed the axle limits or gross vehicle mass (GVM) stated by the original vehicle manufacturer, a certified increase in GVM will be required.





















Ironman 4x4 design and manufacture a range of approved GVM upgrades for a selection of vehicles, which comply with federal and state regulations (Australia and NZ Only). See pages 363 -376 of this catalogue.

Comprehensive testing is conducted by Ironman 4x4 and independent engineers to ensure maximum safety, performance and ADR compliance at the increased load carrying capacity.

Ironman 4x4 has obtained Second Stage Manufacturer (SSM) status through the Department of Infrastructure Regional Development and Cities in Canberra. GVM Upgrades are available through selected Ironman 4x4 Australian and NZ distributors only.

ADDITIONAL LOAD

Use the below guide to estimate the additional load in the vehicle. Calculate the load separated over each axle to determine the nearest spring selection based on the recommendations given within the vehicle application pages. Please Note: Weights quoted below are supplied as an approximate guide only.

Bull Bar Aluminium  +40kg	Fuel Tank Extended Capacity  +90kg
Bull Bar Steel  +60kg	Roof Rack Steel 2200mm Tent Rack  +45kg
Winch With Synthetic Rope  +25kg	Rooftop Tent Including bedding  +65kg
Winch With Steel Cable  +45kg	Water Tank 100 Litres  +100kg
Spare Wheel Additional  +50kg	Tray -100kg Aluminium  -100kg
Rear Bar Steel  +65kg	Tray Steel  +400kg
Canopy ABS Plastic  +80kg	Tool Box Average  +100kg
Drawer System 1300mm Twin Drawers  +90kg	Passenger Average  +80kg
Battery Additional  +25kg	Luggage  +100-300kg
Fridge 50 Litre  +30kg	Towing  +100-300kg
	Large Overhang +30%

Vehicles with large rear overhang such as tray or service bodies may amplify loads by approximately 30%.

Suspension Kits and Correct Selection

Ironman 4x4 suspension kits are a simplified way to select the appropriate components for a vehicle. Many vehicles have different suspension requirements according to added load, terrain and driver preferences.

To establish the correct suspension kit, we ask the following questions:

- 1) What is the primary usage of the vehicle?
- 2) What accessories are on the vehicle?
- 3) What additional loads are within the vehicle and how often are the loads present?
- 4) What is the primary driving terrain?

The Ironman 4x4 suspension kit part numbering system is designed to be read as follows:

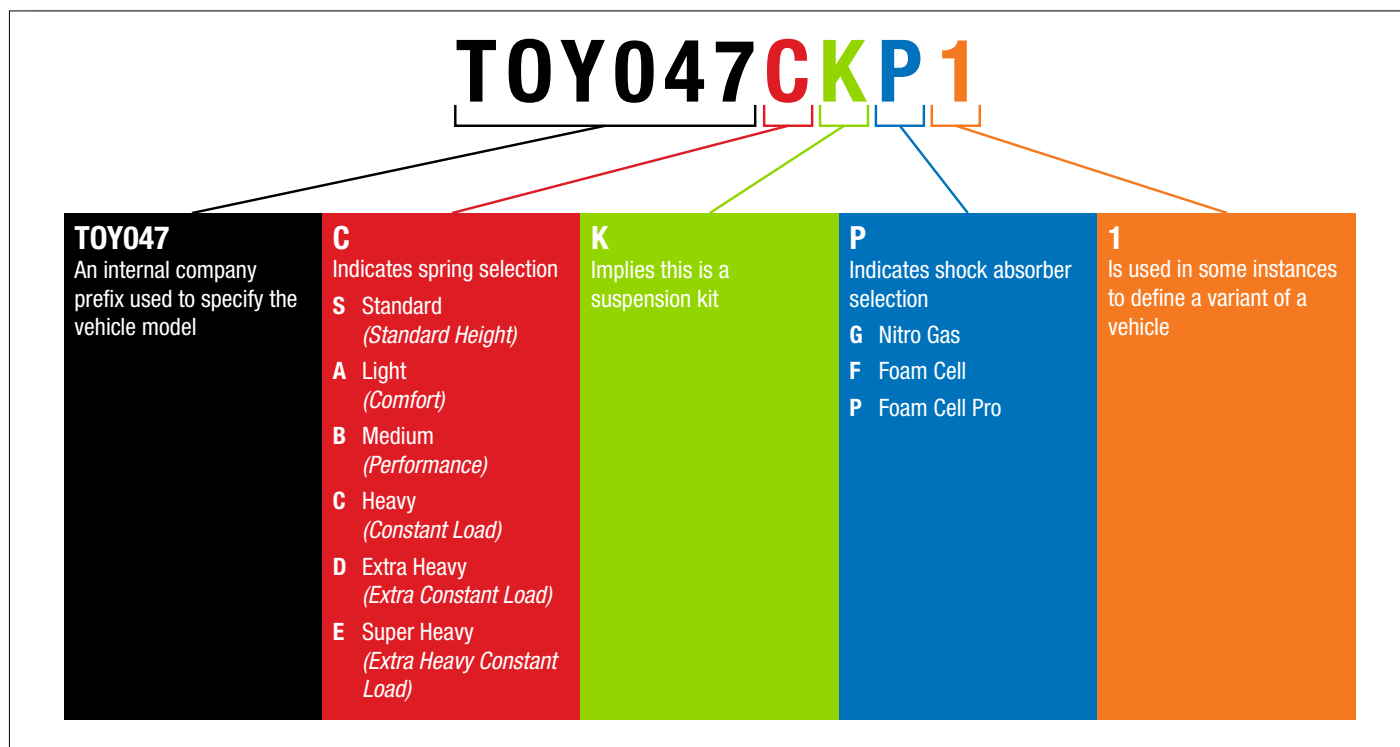

Generally, as no two vehicles are alike, customising a suspension kit is recommended and can be discussed with the Ironman 4x4 team.

For example, a vehicle with heavy load over the rear axle only, does not require constant load front springs, in this case a lighter front spring and heavier rear spring is the best choice.



Application Guide - Shock Absorbers To Suit

To Suit Make	To Suit Model	Year	Nitro Gas		Foam Cell		Foam Cell Pro	
			Front	Rear	Front	Rear	Front	Rear
TO SUIT FIAT	Fullback	2016+	12715GR	12729GR /C /P	24715FE	24729FE /C /P		
TO SUIT FORD	Courier / Ranger	1985 - 2011	12667GR	12095GR /C	24667FE	24095FE /C /P	45667FE	45095FE /C /P
	Ranger T6 PX / PXII	2011 - 6/2018	12727GR	12095GR /C	24727FE	24095FE /C /P	45727FE	45095FE /C /P
	Ranger PXIII (Not US Model)	7/2018+	12827GR	12095GR /C	24827FE	24095FE /C /P	45827FE	45095FE /C /P
	Ranger PXIII (US Model)	7/2018+						
	Everest UA	2015 - 6/2018	12727GR	12732GR	24727FE	24732FE	45727FE	45732FE
	Everest UA II	7/2018+	12827GR	12732GR	24827FE	24732FE	45827FE	45732FE
TO SUIT GMC	Suburban, Tahoe, Sierra, Yukon, Avalanche, Silverado	2007 - 2013	12807GR	12808GR				
	Suburban, Escalade, Tahoe, Sierra, Yukon, Silverado	2014 - 2016	12809GR	12810GR				
TO SUIT HAVAL	H9 Wagon	8/2017+	12710GR	12804GR	24710FE	24804FE		
TO SUIT HOLDEN / GM	Frontera	1995 - 1/1999	12667GR	12644GR	24667FE	24644FE		
	Rodeo KB - TF	1983 - 1988	12087GR	12636GR /C /P	24087FE	24636FE /C /P		
	Rodeo KB - TFS	1988 - 3/2003	12643GR	12636GR /C /P		24636FE /C /P		
	Rodeo / Colorado / RA / RA7 / RC	2003 - 2012	12667GR	12636GR /C /P	24667FE	24636FE /C /P		
	Colorado	2012 - 2020	12745GR	12636GR /C /P	24745FE	24636FE /C /P	45745FE	45636FE /C /P
	Colorado 7 / Trailblazer	2012+	12745GR	12746GR /C	24745FE	24746GR /C	45745FE	45746FE /C
	Jackaroo	Pre 1986	12087GR	12636GR /C	24087FE	24636FE /C		
	Jackaroo	11/1986 - 1991	12087GR	12671GR	24087FE			
	Jackaroo / Bighorn / Monterey	1992+	12643GR	12644GR	24643FE	24644FE		
TO SUIT HYUNDAI	Terracan	2001+	12087GR	12637GR /C	24087FE			
TO SUIT ISUZU	D-Max	2003 - 2012	12667GR	12636GR /C /P	24667FE	24636FE /C /P		
	D-Max Low Ride 2WD	2012+	12797GR	12636GR /C /P		24636FE /C /P		
	D-Max	6/2012 - 7/2019	12745GR	12636GR /C /P	24745FE	24636FE /C /P	45745FE	45636FE /C /P
	D-Max	8/2019+	12845GR	12698GR /C /P	24845FE	24698FE /C /P	45845FE	45698FE /C /P
	MU-X	2013+	12745GR	12746GR /C	24745FE	24746GR /C	45745FE	45746FE /C
	Trooper	Pre 1986	12087GR	12636GR /C	24087FE	24636FE /C		
	Trooper	11/1986 - 1991	12087GR	12671GR	24087FE			
	Monterey	1992+	12643GR	12644GR	24643FE	24644FE		
TO SUIT JEEP	Cherokee XJ	1984+	12665GR	12666GR	24665FE	24666FE		
	Cherokee Liberty KJ / KK	2001 - 2012	12711GR	12712GR				
	Gladiator	5/2020+	12851GR /C				45851FE /C	45854FE /C
	Grand Cherokee ZJ / ZG	1993 - 1998	12665GR	12670GR	24665FE			
	Grand Cherokee WJ / WG	1999 - 6/2005	12774GR	12775GR				
	Grand Cherokee WK2	2011-2016	12735GR					
	Grand Cherokee WK2	2016+	12738GR LH 12738GR RH					
	Wrangler TJ	1996 - 2/2007	12665GR	12669GR	24665FE			
	Wrangler JK	2006+	12751GR	12752GR			45751FE	45752FE
	Wrangler JK 4" Lift	2006+	12751LGR	12752LGR			45751LFE	45752LFE
	Wrangler JL	2018+	12851GR /C	12852GR /C			45851FE /C	45852FE /C
TO SUIT JMC	Vigus	2014+	12710GR	12650GR /C	24710FE	24650FE /C /P	45710FE	45650FE /C /P

/C = Comfort option available. /P = Professional option available. ¹ Bundera / Wrangler LHS ² Bundera / Wrangler RHS ³ 45780FE, Must use Ironman coil springs TOY063



Application Guide - Shock Absorbers To Suit

To Suit Make	To Suit Model	Year	Nitro Gas		Foam Cell		Foam Cell Pro	
			Front	Rear	Front	Rear	Front	Rear
TO SUIT LAND ROVER	Defender 90 / 110 / 130 Series		12080GR	12640GR	24080FE	24640FE	45080FE	45640FE
	Range Rover (Coil Springs)	1971 - 1995	12080GR	12640GR	24080FE	24640FE	45080FE	45640FE
	Discovery Series 1	1989 - 1998	12080GR	12640GR	24080FE	24640FE	45080FE	45640FE
	Discovery Series 2 (Coil Springs)	1999 - 2005	12776GR	12777GR	24776FE	24777FE		
TO SUIT LDV	T60	2017+	12745GR	12636GR /C /P	24745FE	24636FE /C /P	45745FE	45636FE /C /P
TO SUIT MAHINDRA	Scorpio Getaway Pik-Up / Wagon	2002 - 2012	12087GR	12749GR				
	Scorpio Getaway Pik-Up	2012 +	12087GR	12731GR				
TO SUIT MAZDA	B Series Bravo / BT50	1987 - 2011	12667GR	12095GR /C	24667FE	24095FE /C /P	45667FE	45095FE /C /P
	BT50	2011 - 5/2020	12727GR	12095GR /C	24727FE	24095FE /C /P	45727FE	45095FE /C /P
	BT50	6/2020+	12845GR	12698GR /C /P	24845FE	24698FE /C /P	45845FE	45698FE /C /P
TO SUIT MERCEDES-BENZ	G-Wagen W460, W461, W463	1979+	12811GR	12812GR	24811FE	24812FE		
	G-Wagen G55 AMG				24788FE	24789FE		
	Unimog (6 Bolt Axle)						45803FE	45803FE
	Unimog (10 Bolt Axle)						45802FE	45802FE
	X-Class	2017 - 5/2020	12716GR	12728GR	24716FE	24728FE /P	45716FE	45728FE /C /P
TO SUIT MITSUBISHI	Triton / L200	Pre 1993	12082GR	12636GR /C /P	24082FE	24636FE /C /P		
	Triton ME-MJ / L200	1993 - 1996	12082GR	12636GR /C /P	24082FE	24636FE /C /P		
	Triton MK / L200	1996 - 2006	12087GR	12698GR /C /P	24087FE	24698FE /C /P		
	Triton ML-MN / L200	2006 - 2015	12715GR	12636GR /C /P	24715FE	24636FE /C /P		
	Triton MQ-MR / L200	2015 - 10/2018	12715GR	12729GR /C /P	24715FE	24729FE /C /P		
	Pajero / Montero NA-NG (Leaf)	Pre 1991	12082GR	12636GR /C /P	24082FE	24636FE /C /P		
	Pajero / Montero NA-NG (Coil)	1988 - 1991	12082GR	12645GR /C	24082FE	24645FE /C		
	Pajero / Montero NH-NL (Leaf)	1991 - 1999	12087GR	12636GR /C /P	24087FE	24636FE /C /P		
	Pajero / Montero NH-NL (Coil)	6/1991 - 2000	12087GR	12646GR	24087FE	24646FE		
	Pajero / Montero NM-NX	2000+	12713GR	12714GR	24713FE			
	Challenger / Montero Sport PA (Leaf)	1998 - 2006	12087GR	12636GR /C /P	24087FE	24636FE /C /P		
	Challenger / Montero Sport PA (Coil)	1998 - 2008	12087GR	12645GR /C	24087FE	24645FE /C		
	Challenger / Pajero Sport / Montero Sport / Dakar PB	2009 - 2015	12715GR	12645GRS	24715FE	24645FES		
	Pajero Sport / Montero Sport	2015+	12715GR	12645GRS	24715FE	24645FES		
	TO SUIT NISSAN	Delica L400 Without ECS	1994+	12667GR	12698GR	24667FE		
Delica L400 With ECS		1994+	12667GR	12671GR	24667FE			
Patrol MQ / MK G160		Pre 1988	12075GR	12076GR				
Patrol GQ / GU SWB & LWB Wagon		1988 - 1998	12091GR	12094GR	24091FE	24094FE /P	45091FE /P	45094FE /P
Patrol GQ / GU SWB & LWB Wagon 4" Lift					24091LFE	24094LFE /P	45091LFE /P	45094LFE /P
Patrol GQ / GU SWB & LWB Wagon 6" Lift					24091LFE1	24094LFE1	45091LFE1	45094LFE1
Patrol GQ Y60 Cab Chassis (Leaf)			12661GR	12648GR	24661FE	24648FE	45661FE	45648FE
Patrol GU Y61 Cab Chassis (Leaf)			12091GR	12648GR	24091FE	24648FE	45091FE /P	45648FE
Patrol GU Y61 Cab Chassis (Coil)			12091GR	12094GR	24091FE	24094FE /P	45091FE /P	45094FE /P
Patrol GU Y61 Cab Chassis (Coil) 4" Lift					24091LFE	24094LFE /P	45091LFE /P	45094LFE /P
Patrol GU Y61 Cab Chassis (Coil) 6" Lift				24091LFE1	24094LFE1	45091LFE1	45094LFE1	

/C = Comfort option available. /P = Professional option available. ¹ Bundera / Wrangler LHS ² Bundera / Wrangler RHS ³ 45780FE, Must use Ironman coil springs TOY063



Application Guide - Shock Absorbers To Suit

To Suit Make	To Suit Model	Year	Nitro Gas		Foam Cell		Foam Cell Pro	
			Front	Rear	Front	Rear	Front	Rear
TO SUIT NISSAN	Patrol Y62	2009+	12740GR	12742GR	24740FE	24742FE	45740FE	45742FE
	Pathfinder / Terrano / II / R20 / WD21	Pre 1995	12667GR	12636GR /C /P	24667FE	24636FE /C /P		
	Pathfinder R51	7/2005+	12716GR	12718GR	24716FE	24718FE		
	Navara D21	1985 - 1996	12087GR	12636GR /C /P	24087FE	24636FE /C /P		
	Navara D22 / NP300 (Torsion Bar)	1997+	12791GR	12636GR /C /P				
	Navara D40 / Xterra	2005+	12716GR	12717GR	24716FE	24717FE /P	45716FE	45717FE /P
	Navara NP300 (Leaf)	2014+	12716GR	12698GR /C	24716FE	24698FE /C /P	45716FE	45698FE /C /P
	Navara NP300 (Coil)	2015+	12716GR	12728GR	24716FE	24728FE /P	45716FE	45728FE /C /P
	Paladin	Pre 2005	12791GR	12698GR /C		24698FE /C /P		
TO SUIT RAM	1500 DS	2014+					45855FE	45856FE /C
TO SUIT RENAULT / DACIA	Duster	2010+	12747GR	12748GR				
	Alaskan	2017+	12716GR	12728GR	24716FE	24728FE /P	45716FE	45728FE /C /P
TO SUIT SSANGYONG	Musso Q200 SWB	10/2018+	12823GR	12824GR				
	Musso Q201 LWB (Coil)	10/2018+	12823GR	12825GR				
	Musso Q201 / Q205 LWB (Leaf)	10/2018+	12823GR	12826GR				
	Musso / Korando	1996 - 2006	12667GR	12661GRS	24667FE	24661FES		
	Rexton Y400	2018+	12823GR	12828GR				
TO SUIT SUBARU	Forester							
	Outback							
	XV							
TO SUIT SUZUKI	Jimny SN413 / GJ	1998+	12759GR	12760GR				
	Sierra / Samurai LJ / SJ (Leaf)	1981+	12085GR	12086GR				
	Vitara SWB	1988+	12083GR	12089GR				
	Vitara LWB	1988+	12083GR	12658GR				
	Grand Vitara SWB	1988 - 7/2005	12083GR	12089GR				
	Grand Vitara LWB	1988 - 7/2005	12083GR	12658GR				
	Grand Vitara	8/2005 - 2015	12721GR	12722GR				
TO SUIT TOYOTA	4Runner Gen 1, N60 (Leaf)	1988 - 1997	12088GR	12650GR /C	24088FE	24650FE /C /P		
	4Runner / Surf Gen 2, N130 V6 (Coil)	1990 - 1997	12088GR	12637GR /C	24088FE	24637FE /C		
	4Runner Gen 3, N180-N185	1996 - 2002	12691GR	12661GR	24691FE	24661FE	45691FE	45661FE
	4Runner Gen 4 & 5, N210-N280	2003+	12710GR	12682GR /C /P	24710FE	24682FEC /P	45710FE	45682FEC /P
	FJ Cruiser	2006+	12710GR	12682GR /C /P	24710FE	24682FE /C /P	45710FE	45682FE /C /P
	Fortuner	2004 - 2015	12710GR	12743GR /C	24710FE	24743FE /C	45710FE	45743FE /C
	Fortuner	2015+	12730GR	12743GR /C	24730FE	24743FE /C	45730FE	45743FE /C
	Hiace Series 200	2005 - 2019	12667GR	12805GR	24667FE	24805FE		
	Hiace Series 300	2019+			24840FE	24842FE /C		
	Hilux Solid Front Axle	1979 - 10/1983	12639GR /C	12636GR /C /P	24639FE	24636FE /C /P		
	Hilux Solid Front Axle	11/1983 - 11/1997	12639GR /C	12650GR /C	24639FE	24650FE /C /P		
	Hilux / Tiger / 107 / 108 / 110 / 111 / 167	1997 - 2005	12088GR	12081GR /C	24088FE	24081FE /C /P		
	Hilux Low Ride 2WD	2005+	12764GR	12650GR /C		24650FE /C /P		

/C = Comfort option available. /P = Professional option available. ¹ Bundera / Wrangler LHS ² Bundera / Wrangler RHS ³ 45780FE, Must use Ironman coil springs TOY063



Application Guide - Shock Absorbers To Suit

To Suit Make	To Suit Model	Year	Nitro Gas		Foam Cell		Foam Cell Pro	
			Front	Rear	Front	Rear	Front	Rear
TO SUIT TOYOTA	Hilux / Vigo	2005 - 2015	12710GR	12650GR /C	24710FE	24650FE /C	45710FE	45650FE /C
	Hilux / Vigo Long Travel	2005 - 2015	12710GR	12081GR /C	24710FE	24081FE /C /P	45710FE	45081FE /C /P
	Hilux / Revo	2015+	12730GR	12081GR /C	24730FE	24081FE /C /P	45730FE	45081FE /C /P
	Landcruiser 40 / 42 / 45 / 46 / 47 Series	1960 - 1980	12635GR /C	12636GR /C /P	24635FE /C	24636FE /C /P	45635FE	45636FE /C /P
	Landcruiser 60 Series	Pre 1986	12637GR /C	12636GR /C /P	24637FE /C	24636FE /C /P	45637FE /C	45636FE /C /P
	Landcruiser 60 Series	1986+	12637GR /C	12650GR /C	24637FE /C	24650FE /C /P	45637FE /C	45650FE /C /P
	Landcruiser 70 / 73 / 74 Series (Leaf/Leaf)	1984 - 1988	12637GR /C	12650GR /C	24637FE /C	24650FE /C /P	45637FE /C	45650FE /C /P
	Bundera	1984 - 1989	12091GR	12639GRS ¹ 12650GR ²	24091FE	24639FES ¹ 24650FE ²		
	Landcruiser II / Prado 70 / 73 / 78 Series	1990 - 1996	12696GR	12697GR	24696FE	24697FE		
	Landcruiser 71 Series (Coil/Leaf)	1991+	12091GR	12081GR /C	24091FE	24081FE /C /P	45091FE /P	45081FE /C /P
	Landcruiser 75 Series	1984 - 1999	12637GR /C	12081GR /C	24637FE /C	24081FE /C /P	45637FE /C	45081FE /C /P
	Landcruiser 76 / 78 / 79 / 70 & D/Cab	2007+	12091GR	12094GR /C	24091FE	24094FE /C /P	45091FE /P	45094FE /C /P
	Landcruiser 76 / 78 / 79 / 70 & D/Cab Long Travel	2007+			24091FE	24094LFE /P	45091FE /P	45094LFE /P
	Landcruiser 80 / 105 Series	1990+	12683GR	12682GR	24683FE	24682FE	45683FE	45682FE
	Landcruiser 80 / 105 Series 4" Lift	1990+			24683LFE	24682LFE	45683LFE	45682LFE
	Landcruiser 80 / 105 Series 6" Lift	1990+			24683LFE1	24682LFE1	45683LFE1	45682LFE1
	Landcruiser 100 Series IFS	1998+	12795GR	12796GR	24795FE	24796FE	45795FE	45796FE /P
	Landcruiser 200 Series	2007+	12720GR	12796GR	24720FE	24796FE	45720FE	45796FE /P
	Prado 90 / 95 Series	1996 - 10/2002	12691GR	12661GR	24691FE	24661FE	45691FE	45661FE
	Prado 120 Series (except Grande)	4/2003 - 10/2009	12710GR	12682GRC /P	24710FE	24682FEC /P	45710FE	45682FEC /P
Prado 150 Series (except Kakadu)	2009-11/2017	12750GR	12682GRC /P	24750FE	24682FEC /P	45750FE	45682FEC /P	
Prado 150 Series (except Kakadu)	12/2017+	12710GR	12682GRC /P	24710FE	24682FEC /P	45710FE	45682FEC /P	
Tacoma	2005+	12710GR	12744GR	24710FE	24744FE	45710FE	45744FE	
Tundra	2006 - 2021			24780FE	24781FE	45780FE ³	45781FE	
TO SUIT TROLLER	T4	1997 - 6/2014	12765GR	12765GR				
	T4	7/2014+	12755GR	12755GR				
TO SUIT UAZ	Hunter		12652GR	12698GR	24652FE	24698FE		
	Patriot		12637GRS	12698GR	24637FES	24698FE		
TO SUIT VOLKSWAGEN	Amarok	2010+	12725GR	12726GR				

/C = Comfort option available. /P = Professional option available. ¹ Bundera / Wrangler LHS ² Bundera / Wrangler RHS ³ 45780FE, Must use Ironman coil springs TOY063



Features and Benefits

NITRO GAS SHOCK ABSORBERS

Gas Pressurised shock absorber boosts performance and adapts to a wide range of driving styles

NITROGEN GAS PRESSURISED - Low pressure nitrogen gas dramatically reduces the likelihood of oil aeration and shock fade.

35mm TEFLON BANDED PISTON - Precision shim-stack piston specifically valved by Ironman suspension engineers, banded with teflon for smooth long life operation.

54mm TWIN TUBE BODY - Increased oil volume for improved cooling and endurance, Twin tube construction protects internal components from rock damage.

16mm – 18mm HARD CHROME PISTON ROD - Hardened and polished, volumetrically balanced to piston size.

FLEXIBLE RUBBER BUSHES - Offers quieter operation and reduces damaging side loads from shock absorber.

TRIPLE-LIP HIGH PRESSURE NOK SEAL - Maximum gas and oil retention ability to withstand high displacement offroad use.

SUPPLEMENTARY WELDED MOUNTS - Fusion welded and supplementary welded for maximum strength and reliability.

SINGLE PIECE BILLET EYE RINGS AND STEMS - Ultra robust design prevents breakage or bending of mounts.

VEHICLE SPECIFIC VALVING - Every part number is specially valved for each vehicle application, this ensures the best possible ride and handling as intended by Ironman suspension engineers.

LONG TRAVEL - Suitable for standard and raised height vehicles, additional length increases wheel articulation.

IMPACT RESISTANT STONE SHIELD - Steel or Polyethylene dust shield protects piston rod from impacts and road debris.



SUPPLEMENTARY WELDED MOUNTS - Fusion welded then supplementary welded for higher strength and reliability.

360° WELDED MOUNTS - Fusion welded then fully welded around mounting for maximum strength and reliability.

SINGLE PIECE BILLET EYE RINGS AND STEMS - Ultra robust design prevents breakage or bending of mounts.

VEHICLE SPECIFIC VALVING - Every part number is specially valved for each vehicle application, this ensures the best possible ride and handling as intended by Ironman suspension engineers.

LONG TRAVEL - Suitable for standard and raised height vehicles, additional length increases wheel articulation.

IMPACT RESISTANT STONE SHIELD - Steel or Polyethylene dust shield protects piston rod from impacts and road debris.

COIL SPRINGS

Available in a wide range of load ratings to maintain optimum ride height

COLD COILED - CNC cold coiling ensures perfect consistency and accuracy, less heat during manufacture maintains material properties resulting in longer life.

BAR PEELED - Bar peeling is the process of forming the material to an exact size before coiling, this ensures the diameter remains constant and free of flaws along its entire length.

SHOT PEENED - Manipulates material surface tension to reduce stress, greatly enhances spring life.

TRIPLE SCRAGGED - Each coil is fully compressed to a solid state 3 times to minimise coil settling.

PROGRESSIVE AND LINEAR RATE - Used in accordance to original vehicle manufacturers preference, progressive springs increase rate as the spring compresses, linear springs maintain a consistent rate throughout its range.

POWDERCOATED - All springs are electro-static powdercoated for a durable finish.



FOAM CELL SHOCK ABSORBERS

Premium shock absorber for superior endurance in all conditions

FOAM CELL TECHNOLOGY - Micro-Cellular closed cell foam insert maximises cooling efficiency by occupying less internal space than gas within a pressurised shock absorber. Greater oil capacity and more surface area maintains lower operating temperatures.

40-45mm TEFLON BANDED PISTON - Precision shim-stack piston specifically valved by Ironman suspension engineers, banded with teflon for smooth long life operation.

60-72mm TWIN TUBE BODY - 50%-100% more oil volume than a gas shock absorber for superior cooling and endurance. Twin tube construction protects internal components from rock damage.

18-20mm HARD CHROME PISTON ROD - Hardened and polished, volumetrically balanced to piston size.

FLEXIBLE RUBBER BUSHES - Offers quieter operation and reduces damaging side loads from shock absorber.

TRIPLE-LIP HIGH PRESSURE NOK SEAL - Maximum oil retention ability to withstand high displacement offroad use.



LEAF SPRINGS

Available in a wide range of load ratings to maintain optimum ride height

INTER LEAF LINERS - Used in some applications to lower friction between leaves reducing noise and improving - Comfort.

LINED BOLT CLAMPS - All Ironman springs feature bolted guide clamps for greater flex, the addition of anti-friction liners ensures noise free smooth operation.

SHOT PEENED - Manipulates tension side of material to reduce stress, greatly enhances spring life.

DIAMOND CUT LEAVES - Distributes load at the leaf tip and reduces interleaf friction.

MILITARY WRAP - Where applicable, an additional wrap around the leaf eye protects from failure in case of damage.



Features and Benefits

TORSION BARS

Higher spring rate to support extra weight from additional vehicle accessories

UP-SET FORGED ENDS - Stronger than machining alone, forging manipulates steel grain for superior strength and durability.

PREMIUM MICRO-ALLOY STEEL - Exceeds OEM steel grade for ultra long life and less sag.

INCREASED BAR DIAMETER - Higher spring rate better supports added accessories and balances front and rear suspension performance.

X-RAY EXAMINED - Each and every Ironman Torsion Bar is X-Ray tested to eliminate risk of breakage due to material flaw.

DIRECTIONAL PRE-SETTING - Torsion Bars are rotationally pre-set in their direction of installation to reduce spring settling. Each bar is marked for left or right fitment.

POLYURETHANE BUSHES

Provide precise spring location and enables lubrication to increase suspension flex and - Comfort

INJECTION MOULDED POLYURETHANE - High density injection moulded polyurethane material ensures precise location and a durable bearing surface for your leaf springs, making them very durable in hot temperatures whilst providing a soft - Comfortable vehicle ride.

GREASABLE - Polyurethane bushes are greasable to aid in longer life and ensure smooth ride and quiet operation.

SPIRAL BORE AND FLANGES - To distribute lubricating grease evenly throughout the bushing surface when combined with greasable shackles and pins.

SPLINES - Allows the bush to conform to irregularities and grip to the eye surface.



GREASABLE SHACKLES AND PINS

Enables easy re-greasing of polyurethane spring bushes

QUAD-OUTLET GREASABLE - Greasable shackles provide an easy method of re-lubricating polyurethane bushes. Chamfered Quad-Outlet ports distribute grease liberally along the bush surface.

SERVICEABLE - All Ironman shackles and pins feature a serviceable bolt together construction.

ANTI-INVERSION SHACKLE - On selected models, a third pin is positioned on the shackle to protect the spring in the case of inversion.



CASTER CORRECTION PLATES

Used to correct caster angle after raising suspension beyond 100mm (4")

PRE-CONFIGURED CASTER CORRECTION - Fixed 5 degree offset models suit 100mm (4") to 150mm (6") lifted suspension.



STEERING DAMPER

Reduce unwanted vibration and feedback through steering system in rough conditions

FOAM CELL TECHNOLOGY - Micro-Cellular closed cell foam insert allows for the horizontal mounting orientation required by a steering damper.

35mm TEFLON BANDED PISTON - Precision shim-stack piston specifically valved by Ironman suspension engineers, banded with Teflon for smooth long life operation.

54mm TWIN TUBE BODY - Increased oil volume improves cooling and endurance, twin tube construction protects internal components from impact damage.

SUPPLEMENTARY WELDED MOUNTS - Fusion welded and supplementary welded for maximum strength and reliability.

SINGLE PIECE BILLET EYE RINGS AND STEMS - Ultra robust design prevents breakage or bending of mounts.

VEHICLE SPECIFIC VALVING - Every part number is specially valved for each vehicle application, this ensures the steering operation is smooth and unhindered by the effects of rough road driving.



CASTER CORRECTION BUSHES

Available in adjustable or fixed offset designs, used to correct caster angle after raising suspension under 100mm (4")

PRE-CONFIGURED CASTER CORRECTION - Fixed 2 degree offset models suit 50mm (2") lifted suspension.

ADJUSTABLE CASTER CORRECTION - Adjustable offset suit a wide range of lift heights up to 100mm (4")

HIGH DENSITY MATERIALS - Vehicle specific rubber or polyurethane material.



ADJUSTABLE PANHARD RODS

Used to correct axle shift after raising suspension. Adjustable as required to re-centralise axle to vehicle

COMPETITION SPEC - 32mm solid rod used throughout.

FINE THREAD ADJUSTMENT - M32 x 2mm thread ensures precision adjustment for greater accuracy.

OEM STYLE RUBBER BUSHES - Maximum flex and durability. Replaceable OEM style bushes.



EXTENDED SWAY BAR LINKS

Recalibrates sway bar index after raising suspension.

VEHICLE SPECIFIC BOLT ON DESIGN - Easy fitment, utilises OEM mounting locations.

ADJUSTABLE LENGTH - Adjustable extension where possible depending on vehicle model.

PRACTICAL DESIGN - Strongest construction up-spec materials to avoid bending and breaking. Rubber bushes and aircraft grade spherical bearings used where possible depending on vehicle model.



Features and Benefits

POLYURETHANE COIL SPRINGS SPACERS / TRIM PACKERS

Available individually to adjust "side to side" or "front to back" vehicle lean due to uneven load placement



INJECTION MOULDED POLYURETHANE - High density injection moulded polyurethane material ensures precise location and a durable seat with the spring.

PRE-CONFIGURED THICKNESSES - Varied thicknesses allow correct selection according to the amount of lean. Provides 1:1 ratio suspension lift on solid axle vehicles.

SELF LOCATING DESIGN - Raised profile locating flanges prevent packer from becoming dislodged or falling out.

STRUT TRIM PACKERS

For use only with Ironman 4x4 struts, available individually to adjust "side to side" or "front to back" vehicle lean due to uneven load placement.



PRECISE RIDE HEIGHT TUNING - Basic steel collar design fits over Ironman 4x4 struts to adjust spring seat height.

PRE-CONFIGURED THICKNESSES - Varied thicknesses allow correct selection according to the amount of adjustment required. Usually provides 1:2 ratio suspension lift on independent suspension vehicles.

EXTENDED BRAKE HOSES

Longer brake hose used with suspension lifts over 100mm (4").



DOT SAE J1401 STANDARDS APPROVED CONSTRUCTION - OEM style reinforced rubber hose for safety.

EXTENDED LENGTH - Extended length allows for greater suspension travel.

ADJUSTABLE TRAILING ARMS

Used to correct rear axle tilt and location after raising suspension.



COMPETITION SPEC - 32mm solid rod used throughout.

FINE THREAD ON-VEHICLE ADJUSTMENT - M32 x 2mm thread ensures precision adjustment for greater accuracy.

OEM STYLE RUBBER BUSHES - Maximum flex and durability. Replaceable OEM compatible bushes.

CASTER WEDGES

Adjusts the caster angle within solid axle vehicles, or changes pinion angle to remove unwanted driveline vibration.



SUITS - 60-70mm wide leaf springs. Breakaway side section can be removed for narrower springs.

AVAILABLE IN - 1, 2, 3 and 4 degree increments.

SWAY BARS

Enhanced performance direct replacement sway bars featuring maximum bar diameter with factory compatible fitment.



SHORE A 70 DURO NR - Bushes maximum flex and durability.

ADJUSTABLE STEERING RODS

Adjustable length rod to centralise steering wheel after suspension lift.



ADJUSTABLE LENGTH - Compatible with all suspension ride heights.

STRONGER CONSTRUCTION - Reduces likelihood of failure due to impact.

BOLT ON STEERING DAMPER MOUNTS - Steering damper mounts can be positioned freely as required to suit suspension lift.

STRUT MOUNTS

Direct replacement for the OEM mounts. Facilitates the pre-assembly of complete new struts without disassembly of old unit.



FULLY OEM COMPATIBLE - Easy Installation.

SHORE A 80 DURO NR BUSHES & INSULATORS - Extended durability and precise location accuracy.

HEAVY DUTY WASHERS - Resists deformation in extreme use.

ADD-A-LEAF

Additional universal tapered leaf to upgrade existing leaf springs.



Eliminates suspension sag and supports additional load.

Improves - Comfort and handling.

Increases load carrying capability and ride height.

RUBBER BUSHES

Direct replacement for the OEM bushes, compatible with OEM and Ironman 4x4 suspension arms.



OEM STYLE RUBBER BUSHES - Easy press in replacement bushes, retains factory ride quality.

SHORE A 70 DURO NR - Maximum flex and durability.

PRO-FORGE CONTROL ARMS

Provides corrected wheel alignment and greater operating clearance, allows for the installation of larger tyres and further increases ride height.



HIGH STRENGTH FORGED ALLOY - Stronger and more durable than a cast, machined or fabricated arm.

BUSHES AND BALL JOINT - Replaceable with OEM compatible or genuine components.

Features and Benefits



SUSPENSION KITS

Fully integrated suspension kits containing all required components to achieve a safe and balanced suspension performance.

ALL LEAF SPRINGS KITS CONTAIN: Springs, Shock Absorbers, U-bolts and Bushes.

ALL COIL SPRINGS KITS CONTAIN: Springs and Shock Absorbers.

Ironman 4x4 also offer various optional components further enhancing suspension performance or geometry correction purposes, see vehicle listings for model specific details.

Such components include Greasable Shackles & Pins, Steering Damper, Caster Correction, Trim Packers, Suspension Arms.



LEAF / LEAF (LL) SUSPENSION KIT



STRUT / LEAF (SL) SUSPENSION KIT



COIL / COIL (CC) SUSPENSION KIT



STRUT / COIL (SC) SUSPENSION KIT



TORSION BAR / LEAF (TL) SUSPENSION KIT



TORSION BAR / COIL (TC) SUSPENSION KIT

Please note: Not all coil springs are available in green and some may be supplied in yellow. Please check before ordering.

Load Plus Helper Springs



Load Plus

Helper Spring Kit



**Without
Load Plus**



**With
Load Plus**

- ✓ Maximise vehicle payload
- ✓ Reduce sway by up to 40%
- ✓ Improve safety and stability
- ✓ Reduce brake pitch by up to 20%
- ✓ Reduce tyre, brake and suspension wear
- ✓ Improve ride by up to 35%
- ✓ Reduce rear end sag by up to 20%



Load Plus Helper Springs - Application Guide

TO SUIT CHRYSLER / DODGE / PLYMOUTH		Part No
B1500, B2500, B3500 - Vans	All	LP7
Caravan, T & C Van & Voyager	All	LP7
	All	LP4
D50 & Ram 50	All	LP4
D100, D150, D200 & D250	All	LP4
Dakota	All	LP4
Durango	All	LP4
R1500 & R2500	w/ 2.5" Leaf	LP4
R1500 & R2500	w/ 3.0" Leaf	LP7
Raider	All	LP4
Ramcharger & Trailduster	All	LP4
W100, W150, W200 & W250	All	LP4
TO SUIT DAIHATSU		
Feroza F300, F310	88-99	LP1
Feroza II	All	LP4
Rocky	All	LP1
TO SUIT FIAT		
Fullback	All	LP3
TO SUIT FORD / LINCOLN / MERCURY		
Bronco	w/ 2.5" Leaf	LP4
	w/ 3.0" Leaf	LP7
Bronco II	w/ 2.5" Leaf	LP4
	w/ 3.0" Leaf	LP7
Courier / Ranger (Not USA model)	All	LP3
Econovan & Spectron	All	LP1
E Series Vans	w/ 2.5" Leaf	LP4
	w/ 3.0" Leaf	LP7
Excursion	All	LP7
Explorer	w/ Leaf	LP4
Falcon Sedan XR-XD	All	LP4
Falcon Panel Van XR-XH	All	LP4
Falcon Utility 1 Tonne XR - On	All	LP4
F Series	w/ 2.5" Leaf	LP4
	w/ 3.0" Leaf	LP7
Mountainer & Aviator	All	LP4
Ranger (USA model only)	All	LP4
* Not suitable for Falcon wagon, except dedicated LPG		
TO SUIT GENERAL MOTORS / CHEVROLET / HOLDEN		
Commodore 1 Tonne	All	LP1
Jackaroo	All	LP3
Rodeo / Colorado / D-Max*	81-03	LP3
Shuttle	All	LP3
Utility and Van HQ-WB	All	LP4
Astro & Safari Van	w/ Leaf	LP4
C, K, R & V Series 1/2 & 3/4 Ton	w/ 2.5" Leaf	LP4
	w/ 3.0" Leaf	LP7
Denali & Escalade	All	LP7
G Series, Express 1/2 3/4 & 1 Ton	w/ 2.5" Leaf	LP4
	w/ 3.0" Leaf	LP7
Savannah Vans 1/2 3/4 & 1 Ton	w/ 2.5" Leaf	LP4
	w/ 3.0" Leaf	LP7
LUV	All	LP3
S10 Blazer & T10	All	LP4
S15 Jimmy, T15 & Sonoma	All	LP4
Suburban 1/2 3/4 Ton	w/ 2.5" Leaf	LP4
	w/ 3.0" Leaf	LP7
Tahoe & Yukon	w/ 2.5" Leaf	LP4
	w/ 3.0" Leaf	LP7
Silverado	All	LP7
*Not suitable for Rodeo / Colorado / D-Max 2003+ Models with interleaf liners		
TO SUIT HONDA		
Passport	w/ Leaf	LP3
TO SUIT INTERNATIONAL		
Scout	All	LP3

TO SUIT ISUZU		
Amigo	All	LP3
Hombre	All	LP3
Pickup, P'up	All	LP3
Rodeo	w/ Leaf	LP3
Trooper II	w/ Leaf	LP3
TO SUIT JEEP		
Cherokee & Wagoneer	All	LP4
CJ5, CJ6 & CJ7	All	LP4
Comanche Pickup	All	LP4
Gladiator Pickup	All	LP4
J10 & J20 Series	All	LP4
Wrangler YJ	All	LP4
TO SUIT KIA		
Pregio	All	LP4
TO SUIT LDV		
T60	All	LP2
TO SUIT MAZDA		
Navaho	All	LP4
Pickups	All	LP3
Bravo / BT50	All	LP3
B1800 / B2000 4x2	All	LP3
B2200 / B2600 4x2 4x4	All	LP1
E1400	All	LP1
E1800	All	LP1
E2000	All	LP1
E2200	All	LP1
TO SUIT MERCEDES BENZ		
MB100	99-02	LP4
MB140	99-02	LP4
Sprinter	98 On	LP4
TO SUIT MITSUBISHI		
Pickup	All	LP4
Pajero / Montero	w/ Leaf	LP4
Triton ME-MN L200	All	LP4
Triton MQ L200	All	LP3
L200 / L300 Van	All	LP4
Starwagon / Express Van	All	LP4
TO SUIT NISSAN		
Frontier	All	LP2
X-Terra	All	LP2
Titan	All	LP2
Navara D21 D22	All	LP3
Navara D40	All	LP2
Navara NP300 (leaf)	All	LP2
Urvan	All	LP3
Patrol GQ / GU Cab / Chassis	All	LP4
Patrol MQ / MK, G160, Y260	All	LP3
TO SUIT SUZUKI		
Sierra / Samurai	All	LP5
TO SUIT TOYOTA		
To Suit Pickups	All	LP2
To Suit T100	All	LP4
To Suit Tundra	All	LP3
To Suit Hiace	All	LP3
To Suit Hilux / 4Runner	All	LP2
To Suit Landcruiser FJ40 / BJ40-42	60-84	LP4
To Suit Landcruiser FJ / HJ60 / 61 / 62	80-90	LP4
To Suit Landcruiser HJ / HZJ 75*	84-99	LP4
To Suit Landcruiser HZJ 78 / 79*	All	LP9
To Suit Landcruiser 76*	All	LP4
To Suit Tacoma	All	LP2
To Suit Townace	All	LP1
* Suits Landcruiser drum brake rear models only		
TO SUIT VOLKSWAGEN		
Amarok	All	LP4



DRIVE LIKE A PRO

Suspension kits built for
Comfort - Performance - Constant Load



FOAMCELL^{PRO}
Suspension Kit

The ultimate upgrade with the most
robust design suitable for all conditions

Colours and styles may vary between models. Prices do not include freight or fitting and are subject to change without notice.

www.ironman4x4.com



Suspension Specifications

Effective 1 May 2021

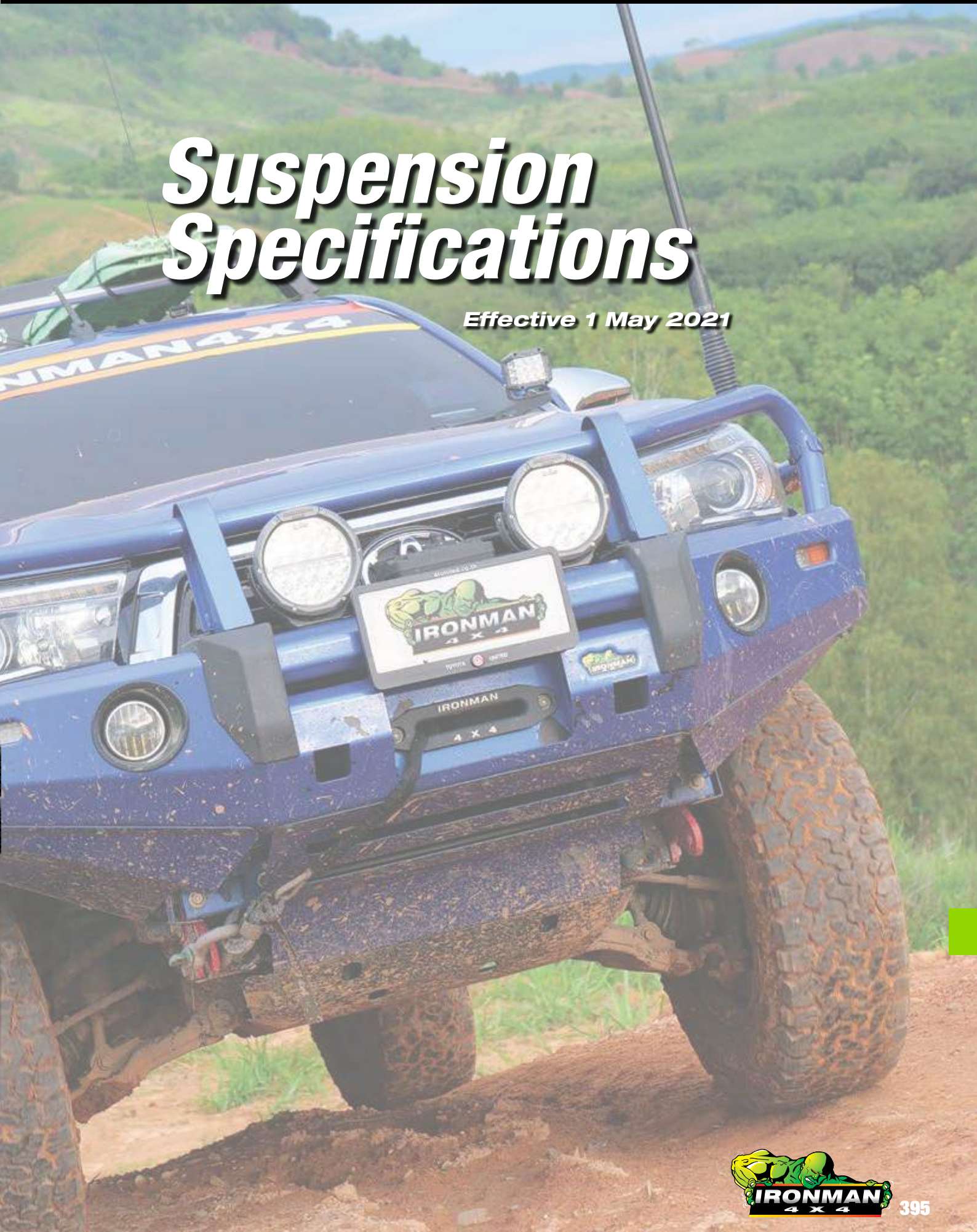

Recommended Installation Times

Average installation times are based on one experienced fitter with all the necessary tools and equipment

SUSPENSION KITS

COIL SPRINGS Front	LEAF SPRINGS Rear	3 Hours
STRUT Front	COIL SPRINGS Rear	3 Hours
STRUT Front	LEAF SPRINGS Rear	4 Hours
TORSION BAR Front	COIL SPRINGS Rear	3 Hours
TORSION BAR Front	LEAF SPRINGS Rear	4 Hours
COIL SPRINGS Front and Rear		2 Hours

LEAF SPRINGS Front and Rear	5 Hours
STRUT Front and Rear	4 Hours
LAND ROVER MODELS	3 Hours
VOLKSWAGEN AMAROK	5 Hours
MITSUBISHI PAJERO 2000 +	4 Hours
MITSUBISHI TRITON 2005 +	5 Hours

SUSPENSION COMPONENTS

COIL SPRINGS Pair	1 Hour
COIL SPRINGS Pair Independent Suspension	2 Hours
COIL SPRINGS Pair with Existing Airbags	2 Hours
LEAF SPRINGS Pair	2 Hours
LEAF SPRINGS Pair with Existing Airbags	2.5 Hours

TORSION BARS Pair	2 Hours
STRUT SHOCK ABSORBERS Pair	2 Hours
SHOCK ABSORBERS Pair	1 Hour
STEERING DAMPER	0.5 Hour
CASTER CORRECTION BUSHES	2 Hours

All times to be used as a guide only, times may vary depending on experience and equipment. Pre existing modifications or accessories may also increase installation times. Always allow extra time for unforeseen issues or rusted components. Always use Ironman 4x4 Suspension Installation Form to record ride height before and after, vehicle and owner details.

WHEEL ALIGNMENT

SOLID AXLE Wheel Alignment	0.5 Hour
--------------------------------------	-----------------

INDEPENDENT SUSPENSION Wheel Alignment	1 Hour
--	---------------

Ironman 4x4 recommend a wheel alignment be performed after installation or within 1 week, always ensure suspension is fully settled before wheel alignment.

As a minimum, toe settings will require adjustment after raising suspension. Camber and Caster settings are an important aspect and should be maintained close to manufacturers specifications.

Consideration to road crown should be given.

It is advisable to induce slightly more (positive caster) and (negative camber) on the kerb side wheel to help maintain directional stability.

As a general rule of thumb it is recommended to adjust as follows: (Unless tyre wear dictates otherwise).

Independent Front Suspension vehicles will generally result in increased toe-in when raised.

Total Toe: +1mm to -1mm.

Solid Front Axle vehicles generally only allow toe adjustment.

Total Toe +1mm to -1mm

4 Wheel Independent Suspension vehicles will require a 4 wheel alignment to ensure front and rear wheels are true to the geometric centreline of the vehicle.

Rear Total Toe: +1mm to +3.5mm (Do not set with Toe Out)

Front Total Toe: +1 to -1mm

Optimal wheel alignment settings can vary between vehicles, the above is to be used as a guide only, different ride heights may require different settings. Always monitor tyre wear and pressures and adjust accordingly.

Installation Form



SUSPENSION INSTALLATION FORM IRONMAN 4X4

Please copy and complete this form at the time of installation.
Keep in a safe place for future reference.

Always ensure you have all the correct parts before beginning installation.

Installing suspension often requires special tools and expert knowledge. All fitment should be performed by a qualified and experienced fitter. Always tighten bushed components after the vehicle is let down onto the ground at normal ride height, otherwise damage from torsional stresses can occur.

Ironman 4x4 recommends a wheel alignment after fitment of new suspension, consideration to natural spring settling should be taken into account before alignment is done. Always adhere to vehicle manufacturers torque specification when tightening fasteners.

Always grease polyurethane bushes prior to fitment, Ironman 4x4 recommends a molybdenum based grease or grease specified for polyurethane.

**If necessary, brake proportioning valve should only be adjusted and tested by a qualified brake specialist.
Further ADAS or TSS safety systems may need to be recalibrated by a qualified service technician.**

OWNER DETAILS

NAME: PHONE:

ADDRESS:

VEHICLE DETAILS

MAKE: MODEL: VIN / REG NO:

ODOMETER: ENGINE TYPE: BODY TYPE:

PRE EXISTING MODIFICATIONS OR WEIGHTED ACCESSORIES:

PART NUMBERS INSTALLED

PART # BATCH# PART # BATCH#

PART # BATCH# PART # BATCH#

PART # BATCH# PART # BATCH#

PART # BATCH# PART # BATCH#

PART # BATCH# PART # BATCH#

SUSPENSION MEASUREMENTS

VEHICLE HEIGHT
LOWER OF WHEEL RIM TO GUARD

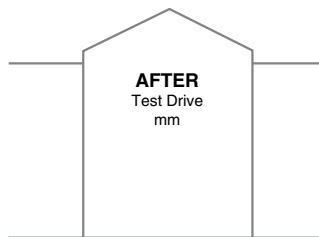
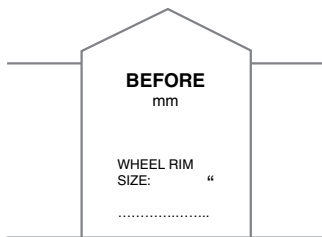

SUSPENSION MEASUREMENTS

ACTUAL MEASUREMENT OF NEW SPRINGS
PRIOR TO INSTALLATION

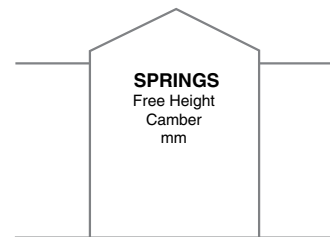

NOTES AND COMMENTS

NOTES:

.....

POST INSTALLATION INSPECTION

All fitting, fasteners and wheels have been tensioned to the correct manufacturers specifications and marked with a paint pen where appropriate.

INSTALLERS NAME: PRINT NAME

SIGNATURE:

DATE OF INSPECTION:

All measurements to be taken prior to installation, immediately after initial test drive and again at 500km check.
All vehicle height measurements to be taken from lower of wheel rim to guard unless otherwise stated. Up to 10mm height reduction in springs can be considered normal settling over time. All measurements are metric except wheel rim size.
Suspension product warranty period is 3 years or 60,000km, GVM warranty period is 2 years or 40,000km unless otherwise stated.

SIF/240920 Rev.2



Coil Springs

COIL SPRING MEASUREMENT REFERENCE

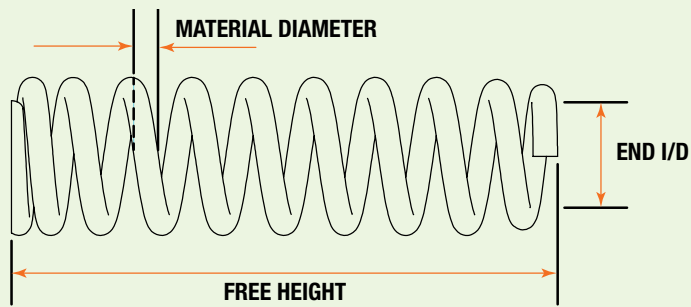

Part Number	Material	Free Height	End I/D	Spring Rate N/mm	Spring Rate lb/in
FOR001A	17	372	81	115	656
FOR001B	17.5	375	81	124	708
FOR001C	18	373	81	136	776
FOR001S	17.5	355	81	124	708
FOR003B	18	505	90/135	40-56	228-320
FOR003C	18	515/520	90/135	56	320
FOR003S	18	475	90/135	40-56	228-320
FOR005A	17.5	381	81	118	673
FOR005B	18	381	81	126	719
FOR005C	18	387	81	132	753
FOR005S	18	365	81	126	719
HOLD008B	16.4	425	104	43	246
HOLD008C	17	420	106	48	274
HOLD020A	16.5	382	66/76	100	571
HOLD020B	17	375	66/76	110	628
HOLD020C	18	370	66/76	127	725
HOLD020S	17	362	66/76	100	571
HOLD022A	15	400	66	40	228
HOLD022B	16	410	65	47	269
HOLD022C	17	415	65	58	331
HOLD022S	15	380/375	65	40	228
HOND001B	13	360/355	61/70	52	297
HOND002B	13.5	420	72/79	40	229
HYUND003B	17	407	148	33	189
IMAZ001B	16	395	102	49	280
JEEP003B	15	432/436	65/100	37	211
JEEP006B	14	380/375	62/102	32	183
JEEP007B	15	440/435	66/100	36	206
JEEP008B	16	345/335	72	35	200
JEEP012B	15	420/410	98	39	223
JEEP012C	15	440/430	98	38	217
JEEP013B	16	370/360	75	43	246
JEEP014B	16.5	375	82	78	446
JEEP014C	16.5	382	82	78	446
JEEP015B	17	323	85/115	38	217
JEEP016B	15.5	468	70/102	38	217
JEEP017B	15	460/450	73.5/103	32	183

Part Number	Material	Free Height	End I/D	Spring Rate N/mm	Spring Rate lb/in
JEEP017C	15.5	460/450	73.5/103	36	206
JEEP018A	15.5	388	52/103	40	229
JEEP018B	16	388	52/103	45	257
JEEP019B	15	500	73/103	32	183
JEEP020B	16	417	56/103	43	246
JEEP021EA	17	420	58.5/95	61	349
JEEP025B	15.5	448	65/88	57	326
JEEP025C	15.5	463	65/88	57	326
JEEP026B	20	368	55/90	114	650
JEEP026C	21	365	55/90	154	879
JEEP029A	14	443	74/102	27	154
JEEP029B	14	455/450	74/102	27	154
JEEP029C	14	475/480	74/102	27	154
JEEP030A	15	388/393	71/78	28	160
JEEP030C	16	415/420	71/78	36	206
JEEP031B	15	505	74/102	27	154
JEEP032B	16	520	65/130	29	166
JEEP032C	17	525	65/130	36	206
JEEP032D	19	520	65/130	44	251
JEEP030B	16	395/400	71/78	31	177
KIA007B	16	387	79/129	35	201
LADA001B	16	285	92	89	509
LADA002B	14	435	100	32	183
LAND005B	17	400	118	41.1	535
LAND006B	20	405	134	81	462
LAND006C	21	440	134	81.9	468
LAND007B	16	390/382	118	41	234
LAND008B	17	440	134	36.6	209
LAND009B	16	405/395	117	36	206
LAND011B	17	425/420	117	46-53	262-302
LAND011C	18	425/420	118	56-64	319-365
LAND014B	15	410/390	117	30	171
LAND019B	17	415	90	83	474
LAND019C	17	427	90	83	474
LAND020B	21	402	80/100	82	469
LAND020C	21	415	80/100	88	503
MAH003B	15	405	97	46	263

Coil Springs

Part Number	Material	Free Height	End I/D	Spring Rate N/mm	Spring Rate lb/in
MERC015B	14.5	495/485	110	28	160
MERC016B	18	445/433	140	28-44	159-251
MERC020B	15	498	111	30.2	172
MERC021B	12, 15, 16 & 18	470	140	20-40	114-228
MITS020B	17	405/400	145	34	194
MITS020C	18	420	148	39	223
MITS022B	16	410/400	145	27	154
MITS025B	17	390	124	45	257
MITS034B	16	367	140	35	200
MITS035B	14	315/305	120	40	229
MITS038B	19	323	72/93	141	806
MITS038C	19	336	72/93	141	806
MITS039A	21	330/320	113	136	777
MITS039B	21	350/340	113	136-166	777-948
MITS039C	22	335	113.5	162-196	925-1119
MITS040A	17	325	64/93	105	600
MITS040B	18	325	64/92	110	628
MITS040C	18	330	64/92	110	628
MITS040S	18	310	64/93	118	674
MITS042A	17	380	145	32	183
MITS042B	17	403	145	32	183
MITS042C	18	360	146	50	286
MITS042S	17	360	145	32	183
MITS045B	18	335	92/67	110	628
NISS007B	16	415/400	89/122	36.9	211
NISS008B	17	490/480	139	33	189
NISS009B	17	410/387	87/122	46	263
NISS009C	18	415/398	89/122	58	331
NISS010B	19	468/448	139	50	286
NISS010C	19	488/470	139	46	263
NISS018B	14	427	106	34	194
NISS020B	19	490/480	139	50	286
NISS020C	20	475/458	139	60	343
NISS020D	22	475/453	139	85	486
NISS024B	17	425/410	87/122	46	263
NISS026B	18	484/469	87/122	48	274
NISS027B	20	535/521	139	52	297
NISS027C	21	552/540	139	70	400
NISS034B	16	400	119/146.5	28	160
NISS035B	15	370	126	29	166
NISS038B	15	325	134/146	36	206
NISS039B	15	325	114/146	36	206
NISS040A	16	375	81	89	508
NISS040B	17	370	81	97	554
NISS040C	17	380	81	97	554
NISS040D	17.5	380	81	96.7	552
NISS042B	19	443	119	75	429
NISS042C	20	443	119	90	514

Part Number	Material	Free Height	End I/D	Spring Rate N/mm	Spring Rate lb/in
NISS043B	19	525/510	87/122	48	274
NISS044B	21	590/575	139	49	280
NISS044C	22/18	585/570	139/132	74	422
NISS045A	20	373	101	135	771
NISS045B	20	385	101	135	771
NISS045C	20	390	101	135	771
NISS045EA	21	385	101	154	878
NISS045EA2	21	380	100	176	105
NISS046A	21	515	119	90	514
NISS046B	21	522	119	90	514
NISS046C	21.5	528	119	99	566
NISS046EA	22	525	121	97	556
NISS046EA1	23	533	121	119	679
NISS046EA2	23	528	119	140	800
NISS058A	16	445	84/121.5	35-45	200-256
NISS058B	16	445	84/121.5	35-60	200-342
NISS058C	18	445	84/121	57	325
NISS058D	18.5	445	85/122	74	423
RAM015A	19	405	70/85	103	588
RAM015B	19	410	70/85	105	599
RAM015C	19	410	70/85	113	645
RAM016A	16	485	65/111.6	37	211
RAM016B	17	495	65/112	44	251
RAM016C	19	505	65/112	63	359
REN001B	13.5	410	99.5/117.5	30	171
REN002B	14	395	99/117	35	200
SSANG002B	16	410	116	41	234
SSANG003B	17	312	60/99	91	519
SSANG003C	17	319	60/99	93	531
SSANG004B	15	375	114.1	42	239
SSANG004C	16	375	114	50	285
SSANG006B	15	395	114.1	42	239
SSANG006C	16	395	114	50	285
SSANG010B	17	298	65/88	123	702
SUB001B	15	350	121/143	31	177
SUB002B	15.5	345/340	128	38.28	219
SUB003B	15.5	355	123/144	30	171
SUB004B	15	365	99/135	39	223
SUB005B	16	298	124/144	53	301
SUB006B	13.5	343	84	50	284
SUB014B	13	390	83.6/77.6	35	199
SUZ003B	16	280	70/80	102	582
SUZ004B	12	345	70/82	25.4	145
SUZ005B	16	290	80.5/70.5	103	589
SUZ006B	13	340	72/82	33	189
SUZ008B	11	325/320	70/82	27	154
SUZ009B	12	372	75/82.5	27	154
SUZ009C	12	387	75.5/82	27	154



Coil Springs

Part Number	Material	Free Height	End I/D	Spring Rate N/mm	Spring Rate lb/in
SUZ010B	12	340/320	75/84	30.9	176
SUZ010C	12.5	363/343	75/84	36	205
SUZ011B	12	335	75/84	30.9	176
SUZ011C	12.5	350	75/84	36	205
SUZ013B	12.5	345	62/80	33	189
SUZ015B	16	320	72/82	86	491
SUZ016B	12.5	360	62/80	33	189
SUZ017B	16	340	72/82	86	491
SUZ018B	14	360	63/96	35	200
SUZ019B	16	381	125	42	240
SUZ019C	16	395	125	42	240
SUZ020A	16.5	363	72	72	440
SUZ020B	17	368	72	88	503
SUZ020C	17	378	72	88	503
TOY012C	19	515/520	84/119	49	280
TOY013B	18	485/495	108/140	40	229
TOY013C	20	490/497	108/140	57	326
TOY013D	21	490/495	108/140	72	411
TOY017A	16	470	90	54-60	308-342
TOY017B	16	463	90	59	337
TOY017EA	18	450	90	88.9	507-619
TOY017S	16	455	90	54-60	308-342
TOY018B	14	395/380	86/100	35	200
TOY019B	16	420/405	86/125	38.2	218
TOY023B	16	395/390	103/133	31	177
TOY023C	17	375/370	103/134	38.2	218
TOY024B	17	480/485	81/116	41	234
TOY024C	17	500/505	82/117	41	234
TOY025B	18	473/483	108/139	40	229
TOY025C	19	460/475	107/139	48	274
TOY025D	22	470/478	108/140	70	400
TOY038B	16	348/357	67/76	108	617
TOY038C	17	357	67/76	133	760
TOY039A	15	398	74/114	31-36	177-205
TOY039B	15	410	74/114	31-36	177-206
TOY039C	17	385	74/114	45-51	256-291
TOY046A	16	470	86/100	50	286
TOY046B	17	463	86/100	57	325
TOY046C	17.5	465	85.5/100	60	342
TOY046D	18	455	85/100	71	405
TOY046EA	19	500	100/85	76	434
TOY046EA1	20	490	99/84	93	532
TOY048B	14	438	100	34	194
TOY048C	14.5	428	100	39	223
TOY049B	17	450	87/125	34	194
TOY049C	18	440	87/125	44	251
TOY055A	16.5	380	66/76	106	606

Part Number	Material	Free Height	End I/D	Spring Rate N/mm	Spring Rate lb/in
TOY055B	17	380	66/76	117	669
TOY055C	18	373	66/76	143	817
TOY055EA	19	365	66/76	171	975
TOY055EA1	19	365	66/76	171	975
TOY056A	16.5	400	83.5/130.5	41	234
TOY056B	17	395	83/130	49	280
TOY056C	18	392	85/129	62	354
TOY060B	20	614/622	84/119	44	251
TOY061B	21	627/637	108/140	43	246
TOY061C	22	565/572	108/140	68	388
TOY063A	19	455/445	74/89	102	583
TOY063B	19	475/465	74/89	102	583
TOY063C	19	475/485	74/89	102	583
TOY063EA	20	445/435	89/73	117	668
TOY063EA1	21	435	74/89	136	775
TOY063EA2	22	430	87/73	186	1064
TOY063S	19	425/415	74/89	113	645
TOY064A	19	440/425	108/144	47	269
TOY064B	19	470/455	108/144	47	269
TOY064C	21	465/475	108/144	65	371
TOY064D	22	465	107/144	80	456
TOY064EA	20	475/465	108/144	50	286
TOY064EA1	24	427	105/144	113	645
TOY064EA2	25	435	108/140	126	718
TOY064S	18	457/442	108/144	42	240
TOY065A	18	390	66/76	126	720
TOY065B	18	382	66/76	145	827
TOY065C	18	380	66/76	145	827
TOY067B	18	300	82/122	90	514
TOY069B	17	420	83/130	48	274
TOY070B	19.5	430	66/89	132	754
TOY070C	19.5	437	66/89	132	754
TOY070EA	22	390	63/88	189	1079
TOY072B	18	365	135/107	59	336
TOY072EA	19	380	107/135	69	393
TOY076C	18	388	140	58	331
TOY079B	17.5	525	101/86	54	308
TOY080A	15	415	114	30	171
TOY082A	15	442	94	96	548
TROL001B	15.5	390	94	58	331
TROL002B	15.5	430	102	39	223
TROL003B	15.5	395	95	52	297
TROL004B	15	435	99	38	216
VOLKS001B	17.5	330	65.5/90	119	679
VOLKS001C	18	330	65.5/90	137	783
VOLKS001D	18	335	65.5/90	137	783

Leaf Springs

LEAF SPRING MEASUREMENT REFERENCE

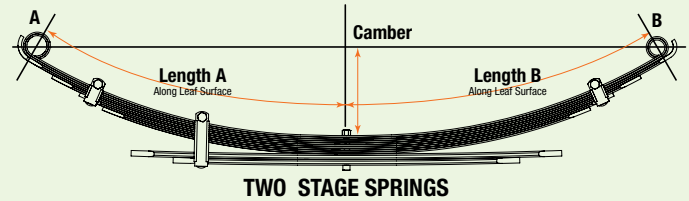
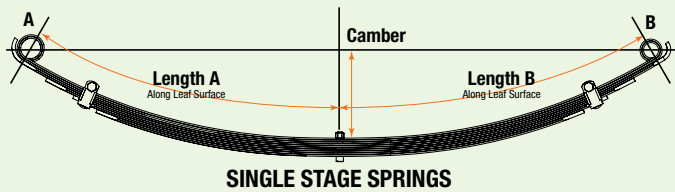

Part Number	Length A	Length B	Camber	Leaves	Width	Eye A	Eye B
FOR002A	585	735	120	5+2	60	55	32
FOR002B	585	735	130	5+2	60	55	32
FOR002C	585	735	145	6+2	60	55	32
HOLD004A	555	650	240/230	5+1	60	40	30
HOLD004B	555	650	250/240	5+1	60	40	30
HOLD004C	555	650	250/240	6+1	60	40	30
HOLD006A	608	602	205	4+1	60	40	30
HOLD006B	608	602	205	5+1	60	40	30
HOLD006C	608	602	205	6+2	60	40	30
HOLD006D	608	602	205	6+2	60	40	30
HOLD021A	607	763	145	5+2	60	40	30
HOLD021B	607	763	155	5+2	60	40	30
HOLD021C	607	763	160	6+2	60	40	30
HOLD021D	607	758	160	6+2	60	40	30
HOLD023B	650	650	175	5+2	60	40	30
HOLD023C	650	650	175	6+2	60	40	30
IMAZ002B	650	700	165	8	60	42	32
ISL6010	270	270	48	1	60		
JEEP004B	585	725	195/175	5+2	63	64.5	44.3
JMC002B	610	690	150	5+2	60	40	30
JMC002C	610	690	130	5+2	60	40	30
MAH002B	612	610	185	5+2	70	35	35
MAZDA006A	530	670	165	5+1	60	32	32
MAZDA006B	530	670	150	6+2	60	32	32
MAZDA006C	530	670	165	6+2	60	32	32
MAZDA006D	530	670	150	7+2	60	32	32
MAZDA041A	590	730	140	4+2	60	40	32
MAZDA041B	590	730	140	4+2	60	40	32
MAZDA041C	590	720	140	5+2	60	40	32
MAZDA041D	590	720	130	6+2	60	40	32
MTS018A	520	685	200	4+1	70	32	28
MTS018B	515	685	195	4+1	70	32	28
MTS018C	515	685	190	5+1	70	32	28
MTS041A	515	685	140	4+1	70	32	28

Part Number	Length A	Length B	Camber	Leaves	Width	Eye A	Eye B
MTS041B	515	685	145	4+1	70	32	28
MTS041C	515	685	155	5+1	70	32	28
MTS047A	550	775	140	5+1	60	40	28
MTS047B	550	775	140	5+1	60	40	28
MTS047C	550	775	140	5+2	60	40	28
NISS003B	560	550	185/170	6	60	22	33
NISS004B	605	835	250/235	8	60	33	33
NISS005B	560	550	185/170	6	60	40	33
NISS011C	550	550	180/170	7	70	40	35
NISS012C	595	825	217/200	7+2	70	35	35
NISS012D	600	830	240/225	7+3	70	35	35
NISS014A	565	635	145/135	4+2	60	40	33
NISS014B	565	635	130/120	4+1	60	40	33
NISS014C	565	635	130/120	5+1	60	40	33
NISS021B	650	580	200	8	60	33	40
NISS041B	670	735	195	5+1	60	40	33
NISS041C	670	730	190	6+1	60	40	33
NISS041D	670	730	180	7+2	60	40	33
NISS047B	635	715	195	7+1	60	40	33
NISS049B	700	650	230	5+1	60	40	33
NISS057B	670	605	175	5+2	60	40	33
NISS057C	670	605	175	6+2	60	40	33
SSANG005B	710	720	200	5+1	70	56	28
SSANG005C	710	720	200	6+1	70	56	28
SUZ001B	480	470	120/110	5	50	30	40
SUZ002B	510	520	175/155	4+1	50	40	30
TOY001B	510	610	160	7	70	25	25
TOY002B	510	620	180	7	70	25	25
TOY003C	660	660	230	7+3	70	30	30
TOY004B	510	610	160	7	70	35	35
TOY004C	502	603	155	8	70	35	35
TOY005C	655	675	230	7+3	70	35	35
TOY006B	555	555	150	7	70	35	35
TOY006C	555	555	175	8	70	35	35



Leaf Springs

Part Number	Length A	Length B	Camber	Leaves	Width	Eye A	Eye B
TOY006D	550	550	175	9	70	35	35
TOY007A	570	655	230/220	7	70	35	35
TOY007B	570	645	220/205	6+1	70	35	35
TOY007C	565	655	230/220	7+1	70	35	35
TOY008B	555	590	180	7	70	35	35
TOY008C	555	590	180	8	70	35	35
TOY009B	610	730	210	6+2	70	40	40
TOY009C	610	720	210	7+2	70	40	40
TOY009D	605	720	215	8+2	70	40	40
TOY009E	610	720	220	9+2	70	40	40
TOY010B	575	575	135/115	5	60	30	30
TOY010C	575	575	130/110	6	60	30	30
TOY011B	530	670	200	4+2	60	30	30
TOY011C	530	670	210	5+2	60	30	30
TOY027A	560	740	200	6+2	60	40	30
TOY027B	560	740	200	4+2	60	40	30
TOY027C	560	740	200	5+2	60	40	30
TOY034B	505	630	205	7	70	35	35
TOY044C	535	670	150	4+2	60	40	40
TOY047A	695	815	245	7+2	70	40	40
TOY047B	698	815	235	8+2	70	40	40
TOY047C	698	815	235	9+2	70	40	40
TOY047D	698	815	235	9+2	70	40	40

Part Number	Length A	Length B	Camber	Leaves	Width	Eye A	Eye B
TOY047E	698	815	250	9+2	70	40	40
TOY057A	610	690	170	6+2	60	40	30
TOY057B	610	690	190	4+2	60	40	30
TOY057C	610	690	190	5+2	60	40	30
TOY057D	610	690	200	6+2	60	40	30
TOY062B	620	785	245	7+2	70	40	40
TOY062C	620	785	245	8+2	70	40	40
TOY062D	625	785	250	10+2	70	40	40
TOY066B	705	705	185/175	5+2	60	40	40
TOY066C	705	705	185/180	6+2	60	40	40
TOY068B	590	685	200	4+2	60	40	30
TOY068C	590	685	190	6+2	60	40	30
TOY071B	800	815	200	4+2	60	40	40
TOY071C	800	815	200	5+2	60	40	40
TOY073B	655	755	130	3	70	70	60
TOY073C	655	755	130	4	70	70	60
TOY077A	700	700	170	5+2	60	40	30
TOY077B	700	700	170	5+2	60	40	30
TOY077C	700	700	170	6+2	60	40	30
TOY077D	700	700	170	6+2	60	40	30
VOLKS002B	750	760	245	5+2	70	60	46
VOLKS002C	750	760	255	6+2	70	60	46

LEAF SPRING SPARE PARTS

099	3/8" x 4" Centre Bolt
098	5/16" x 4" Centre Bolt
635	3/8" x 4" Centre Bolt - Extended Head
CLINER001	Plastic Clip Liner
AFPAD001	Plastic Anti-Friction Pad
IWEDGE04	1 Degree Wedge Kit
IWEDGE08	2 Degree Wedge Kit
IWEDGE10	3 Degree Wedge Kit
IWEDGE12	4 Degree Wedge Kit



Torsion and Sway Bars

TORSION AND SWAY BAR MEASUREMENT REFERENCE

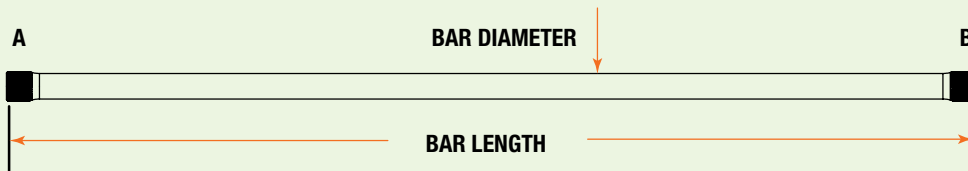

Part Number	Length	Diameter	A End Spline Count	B End Spline Count
HOLD005A	1000	26	43	43
HOLD007	1000	26	47	47
HOLD009	1220	30	47	47
HOLD010	1144	30	47	47
HYUND004	1275	29	43	43
MAZDA005	924	26	40	40
MAZDA014	1025	27	40	40
MAH001	1063	28	43	43
MITSO13	1278	26	39	40
MITSO15C	1370	28	39	40
MITSO19	1308	28	39	40

Part Number	Length	Diameter	A End Spline Count	B End Spline Count
MITSO31	1165	24	40	40
NISS013	1203	26	39	39
NISS017	1232	26	39	39
NISS025	894	26	39	39
NISS048	866	26	39	39
SSANG001	1040	26	40	40
TOY026	1063	26	43	40
TOY042	1212	27	40	40
TOY050	1160	32	46	46
TOY051	1210	32	46	46

SWAY BAR SPARE PARTS	SWAY BAR	REPLACEMENT BUSH	
To Suit Toyota Landcruiser 200 Front	ISB200F	ISBB20038R	Rubber Sway Bar Chassis Bush 38mm
To Suit Toyota Landcruiser 200 Rear	ISB200R	ISBB20033R	Rubber Sway Bar Axle Mounting Bush 33mm
		ISBB200REB	Rubber Sway Bar End Bush
To Suit Nissan Patrol Y62 Front	ISB600F	ISBB60036R	Rubber Sway Bar Chassis Bush 36mm
To Suit Nissan Patrol Y62 Rear	ISB600R	ISBB60027R	Rubber Sway Bar Axle Mounting Bush 27mm
To Suit Toyota Landcruiser 70 Front Diesel	ISB789FW	ISBB78933R	Rubber Sway Bar Chassis Bush 33mm
		ISBB789REB	Rubber Sway Bar End Bush
		ISBB789DB	Chassis Mounting D Bracket
To Suit Toyota Landcruiser 70 Front Petrol	ISB789FWP	ISBB78933R	Rubber Sway Bar Chassis Bush 33mm
		ISBB789REB	Rubber Sway Bar End Bush
		ISBB789DB	Chassis Mounting D Bracket
To Suit Toyota Landcruiser 70 Rear	ISB789RW	ISBB78930R	Rubber Sway Bar Axle Mounting Bush 30mm
		ISBB789REB	Rubber Sway Bar End Bush
		ISBB789DB	Axle Mounting D Bracket
		ISBB789RBK	Chassis Mounting Bracket Set
To Suit Toyota Hilux 2015+ Front	ISB80F	ISBB8033R	Rubber Sway Bar Chassis Bush 33mm

Shock Absorbers



SHOCK ABSORBER MEASUREMENT REFERENCE

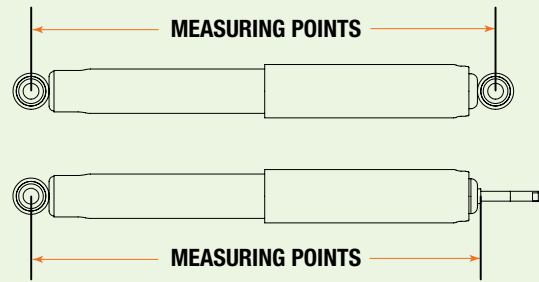

Part Number	Extended (mm)	Compressed (mm)	Upper Mount Type	Upper Replacement	Lower Mount Type	Lower Replacement
12075GR	487	296	ST1	2244K	ST1	2244K
12076GR	583	347	B1	632RF	ST1	2244K
12080GR	552	332	ST38	656RK	ST38	656RK
12081GR	631	388	B2	635RK	B2	635RK
12082GR	342	232	ST1	2244K	CB7	CB7
12083GR	505	310	STEM 57 X M14	-	CLEVIS	-
12085GR	485	298	ST1	2244K	B1	632RF
12086GR	500	313	B1	632RF	B1	632RF
12087GR	350	236	ST1	2244K	ET17	ET17
12088GR	368	245	ST1	2244K	ET113	ET113
12089GR	510	320	ST1	2244K	ET83	-
12091GR	510	310	ST38	656RK	ST38	656RK
12094GR	655	402	B2	635RK	B2	635RK
12095GR	631	382	ET104	ET104	ET69	ET69
12635GR	485	307	B1	632RF	B1	632RF
12636GR	588	357	B1	632RF	B1	632RF
12636GRP	588	362	B1	632RF	B1	632RF
12637GR	577	348	ST1	2244K	B2	635RK
12639GR	484	298	ST1	2244K	ET17	ET17
12640GR	564	343	B2	635RK	ST38	656RK
12643GR	412	261	ST6	2244AK	ET17	ET17
12644GR	510	320	ET153	-	ET36	-
12645GR	531	333	B1	632RF	ET142	-
12645GRS	520	328	B1	632RF	ET142	-
12646GR	495	310	ST1	2244K	ET113	ET113
12648GR	640	385	B2	635RK	ST1	2244K
12650GR	593	364	B2	635RK	B2	635RK
12652GR	540	333	B1	632RF	B1	632RF

Part Number	Extended (mm)	Compressed (mm)	Upper Mount Type	Upper Replacement	Lower Mount Type	Lower Replacement
12658GR	510	320	ST1	2244K	ET83	-
12661GR	535	329	ST1	2244K	B2	635RK
12665GR	565	345	ST1	2244AK	CB7	CB7
12666GR	560	348	CB20	CB20	B5	-
12667GR	381	250	ST1	2244K	ET17	ET17
12669GR	560	348	CB20	CB20	ET24	-
12670GR	562	351	B5	-	ET24	-
12671GR	627	372	ST1	2244K	B1	632RF
12682GR	618	373	ST38	656RK	B2	635RK
12682GRC	618	373	ST38-1	ST38-1	ET38	ET38
12682GRP	618	373	ST38-1	ST38-1	ET38	ET38
12683GR	615	365	ST38	656RK	ST38	656RK
12691GR	462	343	ST38	656RK	ET153	ET153
12696GR	570	347	ET161	-	ST38	656RK
12697GR	520	322	B2	635RK	ST38	656RK
12698GR	624	381	B1	632RF	B1	632RF
12710GR	564	432	STEM 95 X M12	ST710RK	ET153-1	ET153-1
12711GR	318	206	STEM 68 X M10	-	-	-
12712GR	570	357	ET19	-	ET141	-
12712LGR	700	416	ET19	-	ET141	-
12713GR	470	325	STEM 86 X M10	-	ET158	ET158
12714GR	575	351	ST1	ST714RK	ET159	-
12715GR	423	305	STEM 71 X M10	-	ET158-1	ET158-1
12716GR	389	284	STEM 85 X M12	656R	ET153-2	ET153-2
12717GR	575	352	B1	632RF	ET34	ET34
12718GR	380	265	ET159	-	ET159	-
12720GR	600	435	STEM 69 X M14	ST720RK	ET113-1	ET113-1
12721GR	607	382	STEM 28 X M14	-	CLEVIS	-

Part Number	Extended (mm)	Compressed (mm)	Upper Mount Type	Upper Replacement	Lower Mount Type	Lower Replacement
12722GR	545	343	ET83	-	ET83	-
12725GR	615	460	STEM 56 X M12	-	FORK	-
12726GR	602	365	ET69	ET69	ET69	ET69
12727GR	512	378	STEM 65 X M12	ST727RK	ET154	ET154
12728GR	608	369	B1	632RF	ET34	ET34
12729GR	550	339	B1	632RF	B1	632RF
12729GRP	550	343	B1	632RF	B1	632RF
12730GR	560	425	STEM 68 X M12	ST710RK	ET153-1	ET153-1
12731GR	540	333	ET69	ET69	ET69	ET69
12732GR	580	380	STEM 33 X M12	-	ET162	-
12735GR	830	667	STEM 35 X M12	-	CLEVIS	-
12738GR	830	667	STEM 35 X M12	-	CLEVIS	-
12740GR	452	299	STEM 81 X M12	-	ET158-2	ET158-2
12742GR	564	356	ST42	-	ET160	ET160
12743GR	600	362	ST10	ST10RK	ET38	ET38
12744GR	609	361	ST10	ST10RK	ET17	ET17
12745GR	495	359	STEM 64 X M12	ST710RK	ET153-1	ET153-1
12746GR	605	360	ST1	2244K	ET17	ET17
12747GR	625	400	STEM 45 X M14	-	CLEVIS	-
12748GR	711	450	STEM 45 X M14	-	CLEVIS	-
12749GR	530	325	ET69	ET69	B1	632RF
12750GR	562	425	STEM 68 X M12	ST710RK	ET153-3	ET153-3
12751GR	575	325	ST38	656RK	ET69	632RF
12751LGR	650	382	ST38	656RK	ET69	632RF
12752GR	617	374	CB35	CB35	ET69	632RF
12752LGR	665	396	CB35	CB35	ET69	632RF
12755GR	625	381	ET113	-	ET113	-
12756GR	432	293	ET173	-	ET173	-

Part Number	Extended (mm)	Compressed (mm)	Upper Mount Type	Upper Replacement	Lower Mount Type	Lower Replacement
12757GR	650	390	CB34	-	ET34	-
12759GR	440	277	ST1	2244K	ET17	ET17
12760GR	495	310	ET177	ET177	ET177	ET177
12764GR	440	307	STEM 70 X M12	-	ET153	ET153
12765GR	625	380	ET163	-	ET163	-
12774GR	550	336	ST6	2244AK	CB7	CB7
12775GR	575	357	ET61	-	ET65	-
12776GR	587	362	ET172	-	CB34	-
12777GR	587	362	ET172	-	ET172	-
12780GR	613	450	STEM 68 X M12	ST710RK	ET113-1	ET113-1
12781GR	650	384	ST38	ST21RK	ET38-2	ET38-2
12791GR	310	217	ST1	2244K	ET17	ET17
12795GR	447	290	ST21	ST21RK	ET153	-
12796GR	619	369	ST21	ST21RK	B2	635RK
12797GR	415	295	STEM 64 X M12	ST710RK	ET153-1	ET153-1
12804GR	535	345	CB159	-	ET38	ET38
12805GR	570	351	B1	632RF	B2	635RK
12807GR	451	344	STEM 48 X M10	-	CB160	-
12808GR	673	404	ET164	-	ET164	-
12809GR	461	354	STEM 55 X M10	-	CB160	-
12810GR	605	375	ET164	-	ET164	-
12811GR	630	390	ET113	-	ST39	ST39
12812GR	597	375	ST39	-	ET174	ET174
12823GR	478	360	STEM 28 X M10	-	ET174	ET174
12824GR	525	320	STEM 90 X M10	-	ET175	ET175
12825GR	545	330	STEM 90 X M10	-	ET175	ET175
12826GR	580	365	ET176	ET176	ET176	ET176
12827GR	496	376	STEM 65 X M12	-	ET155	ET155

Shock Absorbers



Part Number	Extended (mm)	Compressed (mm)	Upper Mount Type	Upper Replacement	Lower Mount Type	Lower Replacement
24080FE	552	332	ST38	656RK	ST38	656RK
24081FE	631	388	B2	635RK	B2	635RK
24081FEP	631	388	B2	635RK	B2	635RK
24082FE	342	230	ST1	2244K	CB7	CB7
24087FE	349	235	ST1	2244K	ET17	ET17
24088FE	368	246	ST1	2244K	ET113	ET113
24091FE	510	310	ST38	656RK	ST38	656RK
24091FEP	510	310	ST38	656RK	ST38	656RK
24091LFE	557	354	ST38	656RK	ST38	656RK
24091LFE1	597	353	ST38	656RK	ST38	656RK
24091LFEP	557	354	ST38	656RK	ST38	656RK
24094FE	658	402	B2	635RK	B2	635RK
24094LFE	718	429	B2	635RK	B2	635RK
24094LFE1	760	450	B2	635RK	B2	635RK
24094LFEC	718	429	B2	635RK	B2	635RK
24094LFEP	718	429	B2	635RK	B2	635RK
24095FE	630	385	ET104	ET104	ET69	ET69
24635FE	485	310	B1	632RF	B1	632RF
24636FE	587	361	B1	632RF	B1	632RF
24636FEP	587	361	B1	632RF	B1	632RF
24637FE	577	350	ST1	2244K	B2	635RK
24639FE	484	303	ST1	2244K	ET17	ET17
24640FE	564	343	B2	635RK	ST38	656RK
24643FE	412	266	ST6	2244AK	ET17	ET17
24644FE	510	325	ET153	-	ET36	-
24645FE	531	333	B1	632RF	ET142	-
24645FEC	531	333	B1	632RF	ET142	-
24645FES	520	328	B1	632RF	ET142	-
24646FE	495	310	ST1	2244K	ET113	ET113
24648FE	640	385	B2	635RK	ST1	2244K
24650FE	592	366	B2	635RK	B2	635RK
24650FEP	592	366	B2	635RK	B2	635RK
24652FE	540	337	B1	632RF	B1	632RF
24661FE	533	331.5	ST1	2244K	B2	635RK
24665FE	564	346	ST1	2244K	CB7	CB7
24666FE	565	346	CB20	CB20	B5	-
24667FE	382	251	ST1	2244AK	ET17	ET17
24682FE	618	373	ST38	656RK	B2	635RK
24682FEC	618	373	ST38-1	ST38-1	ET38	ET38
24682FEP	618	373	ST38-1	ST38-1	ET38	ET38
24682LFE	670	398	ST38	656RK	B2	635RK
24682LFE1	730	428	ST38	656RK	B2	635RK
24683FE	615	365	ST38	656RK	ST38	656RK
24683LFE	670	390	ST38	656RK	ST38	656RK
24683LFE1	730	420	ST38	656RK	ST38	656RK
24691FE	462	343	ST38	656RK	ET153	ET153
24696FE	570	347	ET161	-	ST38	656RK

Part Number	Extended (mm)	Compressed (mm)	Upper Mount Type	Upper Replacement	Lower Mount Type	Lower Replacement
24697FE	520	322	B2	635RK	ST38	656RK
24698FE	626	381	B1	632RF	B1	632RF
24698FEC	626	381	B1	632RF	B1	632RF
24698FEP	626	381	B1	632RF	B1	632RF
24710FE	540	408	STEM 95 X M12	ST710RK	ET153-1	ET153-1
24713FE	470	325	STEM 86 X M10	-	ET158	ET158
24715FE	423	305	STEM 71 X M10	-	ET158-1	ET158-1
24716FE	389	284	STEM 85 X M12	656R	ET153-2	ET153-2
24717FE	577	356	B1	632RF	ET34	ET34
24717FEC	577	356	B1	632RF	ET34	ET34
24717FEP	575	356	B1	632RF	ET34	ET34
24718FE	380	265	ET159	-	ET159	-
24720FE	600	435	STEM 69 X M14	ST720RK	ET113-1	ET113-1
24727FE	512	378	STEM 65 x M12	ST727RK	ET154	ET154
24728FE	608	373	B1	632RF	ET34	ET34
24728FEP	608	373	B1	632RF	ET34	ET34
24729FE	550	348	B1	632RF	B1	632RF
24729FEP	550	348	B1	632RF	B1	632RF
24730FE	560	425	STEM 68 X M12	ST710RK	ET153-1	ET153-1
24732FE	580	374	STEM 33 X M12	-	ET162	-
24740FE	452	299	STEM 81 X M12	-	ET158-2	ET158-2
24742FE	564	356	ST42	-	ET160	ET160
24743FE	600	365	ST10	ST10RK	B2	635RK
24744FE	610	365	ST10	ST10RK	ET17	ET17
24745FE	495	359	STEM 64 x M12	ST710RK	ET153-1	ET153-1
24746FE	605	366	ST1	2244K	ET17	ET17
24750FE	562	425	STEM 68 X M12	ST710RK	ET153-3	ET153-3
24776FE	587	367	ET172	-	CB34	-
24777FE	587	367	ET172	-	ET172	-
24780FE	613	450	STEM 68 x M12	ST710RK	ET113-1	ET113-1
24781FE	650	387	ST38	ST21RK	ET38-2	ET38-2
24788FE	560	341	ET113	-	ST39	ST39
24789FE	576	349	ST39	ST39	ET174	ET174
24795FE	447	290	ST21	ST21RK	ET153	-
24796FE	615	369	ST21	ST21RK	B2	635RK
24804FE	535	345	CB159	-	ET38	ET38
24805FE	570	355	B1	632RF	B2	635RK
24811FE	630	390	ET113	-	ST39	ST39
24812FE	597	375	ST39	ST39	ET174	ET174
24827FE	496	376	STEM 65 XM12	-	ET155	ET155
24840FE	635	450	STEM 31 x M14	-	CLEVIS	-
24842FE	570	375	B2	635RK	B2	635RK
24842FEC	570	375	B2	635RK	B2	635RK
24845FE	517	359	STEM 64 x M12	ST710RK	ET153-1	ET153-1
24851FE	640	456	ET180	-	ET181	-
24852FE	480	491	ET180	-	ET181	-



Part Number	Extended (mm)	Compressed (mm)	Upper Mount Type	Upper Replacement	Lower Mount Type	Lower Replacement	Seal Service Kit	Seat Insulator	Adjusting Rings
45080FE	552	358	ST38	656RK	ST38	656RK	45SK7220		
45081FE	631	400	B2	635RK	B2	635RK	45SK7220		
45081FEC	631	400	B2	635RK	B2	635RK	45SK7220		
45091FE	510	318	ST38	656RK	ST38	656RK	45SK7220		
45091FEP	510	318	ST38	656RK	ST38	656RK	45SK7220		
45091LFE	557	341	ST38	656RK	ST38	656RK	45SK7220		
45091LFE1	597	361	ST38	656RK	ST38	656RK	45SK7220		
45091LFE3	860	492	ST38	656RK	ST38	656RK	45SK7220		
45091LFEP	557	341	ST38	656RK	ST38	656RK	45SK7220		
45094FE	658	416	B2	635RK	ET38	ET38	45SK7220		
45094FEC	658	416	B2	635RK	ET38	ET38	45SK7220		
45094LFE	718	446	B2	635RK	ET38	ET38	45SK7220		
45094LFE1	760	467	B2	635RK	ET38	ET38	45SK7220		
45094LFE3	860	516	B2	635RK	ET38	ET38	45SK7220		
45095FE	630	398	ET104	ET104	ET69	ET69	45SK7220		
45095FEC	630	398	ET104	ET104	ET69	ET69	45SK7220		
45635FE	485	323	B1	632RF	B1	632RF	45SK7220		
45636FE	587	375	B1	632RF	B1	632RF	45SK7220		
45636FEC	587	375	B1	632RF	B1	632RF	45SK7220		
45637FE	577	363	ST1	2244K	B2	635R	45SK7220		
45640FE	564	357	ET38	ET38	ST38	656RK	45SK7220		
45648FE	640	395	B2	635RK	ST1	2244K	45SK7220		
45650FE	592	380	B2	635RK	B2	635RK	45SK7220		
45650FEC	592	380	B2	635RK	B2	635RK	45SK7220		
45650FEP	592	380	B2	635RK	B2	635RK	45SK7220		
45652FE	540	354	B1	632RF	B1	632RF	45SK7220		
45652FEC	540	354	B1	632RF	B1	632RF	45SK7220		
45661FE	533	343	ST1	2244K	ET38	ET38	45SK7220		
45667FE	382	257	ST1	2244K	ET17	ET17	45SK6520		
45682FE	618	383	ST38	656RK	ET38	ET38	45SK7220		
45682FEC	618	383	ST38-1	ST38-1	ET38	ET38	45SK7220		
45682FEP	618	383	ST38-1	ST38-1	ET38	ET38	45SK7220		
45682LFE	670	409	ST38	656RK	ET38	ET38	45SK7220		
45682LFE1	730	439	ST38	656RK	ET38	ET38	45SK7220		
45682LFE3	860	504	ST38	656RK	ET38	ET38	45SK7220		
45683FE	615	370	ST38	656RK	ST38	656RK	45SK7220		
45683LFE	670	397	ST38	656RK	ST38	656RK	45SK7220		
45683LFE1	730	427	ST38	656RK	ST38	656RK	45SK7220		
45691FE	462	342	ST38	656RK	ET153	ET153	45SK6520	45RSS001	45STAR001
45698FE	626	394	B1	632RF	B1	632RF	45SK7220		
45698FEC	626	394	B1	632RF	B1	632RF	45SK7220		
45710FE	540	408	STEM 95 x M12	ST710RK	ET153-1	ET153-1	45SK6520	45RSS001	45STAR001
45715FE	442	315	STEM 71 X M10	-	ET158-1	ET158-1	45SK6520	45RSS001	45STAR001
45716FE	389	283	STEM 86 x M12	656RK	ET153-2	ET153-2	45SK7220	45RSS004	45STAR002
45716LFE	402	287	STEM 86 x M12	656RK	ET153-2	ET153-2	45SK7220	45RSS004	45STAR002

Shock Absorbers



Part Number	Extended (mm)	Compressed (mm)	Upper Mount Type	Upper Replacement	Lower Mount Type	Lower Replacement	Seal Service Kit	Seat Insulator	Adjusting Rings
45717FE	572	373	B1	632RF	ET34	ET34	45SK7220		
45717FEC	572	373	B1	632RF	ET34	ET34	45SK7220		
45720FE	600	435	STEM 71 x M14	ST720RK	ET113-1	ET113-1	45SK7218	45RSS002	45TAR002
45727FE	512	378	STEM 65 x M12	ST727RK	ET154	ET154	45SK7220	45RSS005	45TAR002
45728FE	608	389	B1	632RF	ET34	ET34	45SK7220		
45728FEC	608	389	B1	632RF	ET34	ET34	45SK7220		
45729FE	445	372	B1	632RF	B1	632RF			
45729FEC	445	372	B1	632RF	B1	632RF			
45729FEP	445	372	B1	632RF	B1	632RF			
45730FE	560	425	STEM 68 X M12	ST710RK	ET153-1	ET153-1	45SK6520	45RSS001	45TAR001
45732FE	580	380	STEM 33 X M12	-	ET162	-	45SK7218		
45732FEC	580	380	STEM 33 X M12	-	ET162	-	45SK7218		
45740FE	452	302	STEM 81 x M12	-	ET158-2	ET158-2	45SK7220	45RSS003	45TAR002
45742FE	564	357	ST42	-	ET160	ET160	45SK7220		
45743FE	600	376	ST10	ST10RK	ET38	ET38	45SK7220		
45744FE	610	379	ST10	ST10RK	ET17	ET17	45SK7220		
45745FE	495	359	STEM 64 x M12	ST710RK	ET153-1	ET153-1	45SK6520	45RSS001	45TAR001
45746FE	605	397	ST1	2244K	ET17	ET17	45SK6520		
45746FEC	605	397	ST1	2244K	ET17	ET17	45SK6520		
45750FE	562	425	STEM 68 x M12	ST710RK	ET153-3	ET153-3	45SK6520	45RSS001	45TAR001
45751FE	575	361	ST38	656RK	B1	632RF	45SK7220		
45751LFE	650	399	ST38	656RK	B1	632RF	45SK7220		
45752FE	617	393	CB35	CB35	B1	632RF	45SK7220		
45752LFE	665	417	CB35	CB35	B1	632RF	45SK7220		
45780FE	613	450	STEM 68 X M12	ST710RK	ET113-1	ET113-1	45SK7218	45RSS002	45TAR002
45781FE	650	401	ST21	ST21RK	ET38-2	ET38-2	45SK7220		
45795FE	447	295	ST21	ST21RK	ET38-1	ET38-1	45SK7220		
45796FE	615	401	ST21	ST21RK	ET38	ET38	45SK7220		
45796FEP	615	401	ST21	ST21RK	ET38	ET38	45SK7220		
45802FE	755	471	ET165	-	ET165	-	45SK7220		
45802LFE	860	524	ET165	-	ET165	-	45SK7220		
45803FE	710	449	ET165	-	ET165	-	45SK7220		
45827FE	496	376	STEM 65 X M12	-	ET155	ET155	45SK7218	45RSS005	45TAR002
45851FE	640	456	ET180	-	ET181	-	45SK6520		
45851FEC	640	456	ET180	-	ET181	-	45SK6520		
45852FEC	640	498	ET180	-	ET181	-	45SK6520		
45854FE	678	446	ET153-1	-	ET153-1	-	45SK7220		
45854FEC	678	446	ET153-1	-	ET153-1	-	45SK7220		
45854FEP	678	446	ET153-1	-	ET153-1	-	45SK7220		
45855FE	542	389	STEM x 30 x M12	-	CLEVIS 72.5 x 16.5	-	45SK6520		
45855LFE	558	389	STEM x 30 x M12	-	CLEVIS 72.5 x 16.5	-	45SK6520		
45856FE	678	446	ET153-2	ET153-2	ET153-3	-	45SK7220		
45856FEC	678	446	ET153-2	ET153-2	ET153-3	-	45SK7220		
45856LFE	700	457	ET153-2	ET153-2	ET153-3	-	45SK7220		
45856LFEC	700	457	ET153-2	ET153-2	ET153-3	-	45SK7220		

Make	To Suit Model	Part No.	OEM Spring Seat Height
To Suit Ford	To Suit Ranger PX, PX II	45727FE	190mm
	To Suit Ranger PX III	45827FE	166mm
To Suit Holden	To Suit Colorado / Trailblazer	45745FE	190mm
To Suit Isuzu	To Suit D-Max	45745FE	190mm
To Suit Mazda	To Suit BT50	45727FE	190mm
To Suit Mercedes	To Suit X-Class	45716FE	105mm
To Suit Nissan	To Suit Navara D40	45716FE	105mm
	To Suit Navara NP300	45716FE	105mm
	To Suit Patrol Y62	45740FE	130mm
To Suit RAM	To Suit RAM 1500 DS	45855FE	185mm

Make	To Suit Model	Part No.	OEM Spring Seat Height
To Suit Renault	To Suit Alaskan	45716FE	105mm
To Suit Toyota	To Suit Prado 90 / 95	45691FE	163mm
	To Suit Hilux / Fortuner 2005-2014	45710FE	229mm
	To Suit Hilux / Fortuner 2015+	45730FE	224mm
	To Suit Prado 120	45710FE	214mm
	To Suit Prado 150 2009-10/2017	45750FE	214mm
	To Suit Prado 150 11/2017+	45710FE	214mm
	To Suit FJ Cruiser / Tacoma	45710FE	214mm
	To Suit Landcruiser 200	45720FE	220mm
	To Suit Tundra	45780FE	245mm with TOY063 Coil

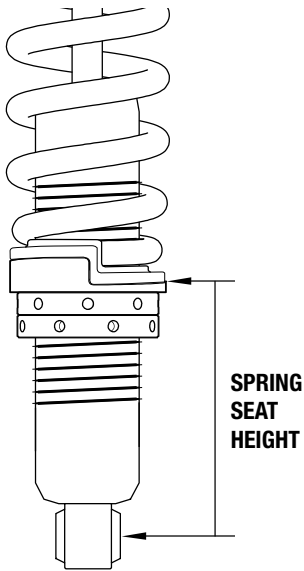

Foam Cell Pro Struts feature a threaded body for ride height adjustment. Use Ironman 4x4, P/N# ISHOCKTOOL001 wrench when making adjustments. It may be necessary to unload the spring tension before making adjustments.

When setting ride height use the OEM shock absorber as a reference for spring seat height, or refer table above.

Many independent suspension systems incorporating struts operate at a 2:1 motion ratio. For every 1mm of movement (compression or extension) at the strut, equates to 2mm movement when measured at the wheel. This MUST be considered when adjusting seat height. For example a 10mm seat height adjustment will provide 20mm change in ride height.

Independent suspension MUST maintain at least 60mm downward travel from ride height. Raising ride height too high can damage the suspension components, impair suspension operation and safety.



ISHOCKTOOL001 Multi-tool for shock absorber service and strut ride height adjustment

Steering Dampers

STEERING DAMPER MEASUREMENT REFERENCE

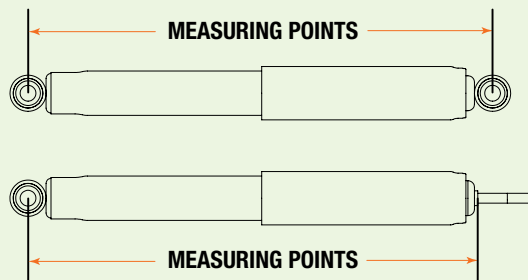

Part Number	Extended (mm)	Compressed (mm)	Upper Mount Type	Upper Replacement	Lower Mount Type	Lower Replacement
3501	550	345	B9	B9MK	B9	B9MK
3502	655	394	ET65	-	ET65	-
3511	525	310	ST1	2244K	ST1	2244K
3517	609	368	B6	-	B6	-
3521	540	340	ST1	2244K	B9	B9MK
3521S	487	293	ST1	2244K	ST1	2244K
3522	541	331	B1	632RF	B1	632RF
3523	458	322	B9	B9MK	B9	B9MK
3524	648	423	B9	B9MK	B9	B9MK
3525	748	443	B9	B9MK	B9	B9MK

Part Number	Extended (mm)	Compressed (mm)	Upper Mount Type	Upper Replacement	Lower Mount Type	Lower Replacement
3530	445	290	ET17	ET17	ET17	ET17
3532	677	439	ST1	2244K	ET57	-
3533	613	368	ET109	-	B9	B9MK
3534	577	350	ET17	ET17	B1	632RF
3536	487	292	ST1	2244K	ST1	2244K
3540	480	298	B1	632RF	ET65	-
3541	528	332	ET65	-	ET65	-
3542	622	419	ET17	-	B1	-
3543	725	520	ET65	-	ET65	-
3544	535	338	ET65	-	ET65	-

Shock Absorber Mount Types

SHOCK ABSORBER MOUNTS MEASUREMENT REFERENCES

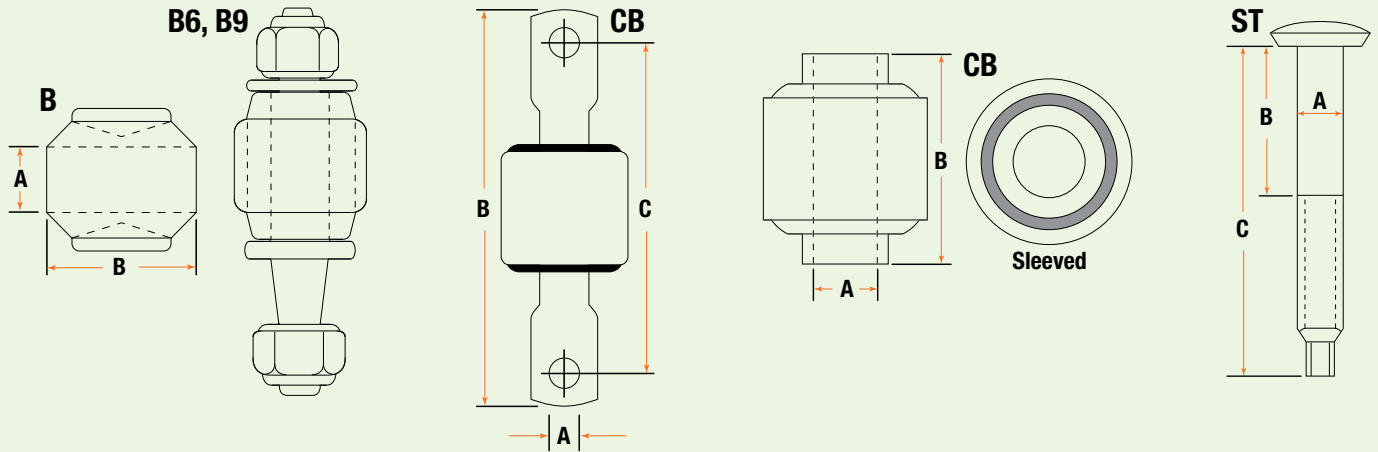

Type	A Diameter	B Length	
B1	16	36	
B2	19	43.5	
B5	15.5	33	
B6	16	36	Adaptor
B9	16	36	Adaptor
CB20	13	95	77
CB34	11	97	75
CB35	10	90	80
CB7	11.5	78	62
CB159	10	116	95.5
CB160	11.5	128	100
ET104	20	43	
ET109	10	24.1	
ET113	16	38.5	
ET113-1	16	38.5	Sleeved
ET141	12	41	
ET142	16	36.5	
ET153	14	40	Sleeved
ET153-1	14	40	Sleeved
ET153-2	14	41.5	Sleeved
ET153-3	14	41.5	Sleeved
ET154	16	38	Sleeved
ET155	20	49.5	Sleeved
ET158	14	50	Sleeved
ET158-1	14	50	Sleeved
ET158-2	14	50	Sleeved
ET159	14	48	Sleeved
ET160	14	53	Sleeved
ET161	16	70	
ET162	14	61.5	Sleeved

Type	A Diameter	B Length	
ET163	16	32.5	Sleeved
ET164	14.5	43	
ET165	20	55	
ET17	12	31.5	
ET172	12.4	43.5	
ET173	13	42.5	
ET174	12	38	Sleeved
ET175	12.2	38	Sleeved
ET176	16	38	
ET177	12	32	Sleeved
ET180	13	70	
ET181	13	40	
ET19	12	46	
ET24	12.5	36	
ET34	14	41.5	
ET36	19	44	
ET38	19	45.5	
ET38-1	14	38	
ET38-2	12	39	
ET57	10	26.1	
ET61	12	46	
ET65	12	36	Sleeved
ET69	12	40	Sleeved
ET83	12	37.5	Sleeved
ST1	10	26	60
ST10	12	39	64
ST21	17	59	84
ST38	14	43	70
ST38-1	14	43	70
ST42	Rectangle M12	44	80
ST6	11	34	65

Trim Packers

TRIM PACKER MEASUREMENT REFERENCE

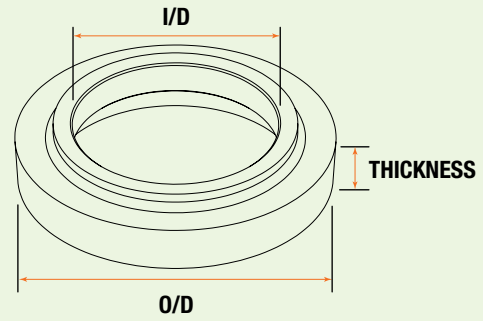

Part Number	O/D	I/D	Thickness	Material
HILFR05	63	54.5	5	Steel
HILFR05F	63	60.5	5	Steel
HILFR10	63	54.5	10	Steel
HILFR10F	63	60.5	10	Steel
HILFR15	63	54.5	15	Steel
HILFR15F	63	60.5	15	Steel
LC70F30	138	86	30	Polyurethane
LCF20	160	114.5	20	Polyurethane
LCF30	160	114.5	30	Polyurethane

Part Number	O/D	I/D	Thickness	Material
LCPR20	168	108	20	Polyurethane
LCPR25	168	108	25	Polyurethane
LCR15	187	133.5	15	Polyurethane
LCR30	187	133.5	30	Polyurethane
PATF15	172	116	15	Polyurethane
PATF30	172	116	30	Polyurethane
PATR15	180	120	15	Polyurethane
PATR30	180	120	30	Polyurethane

U-Bolts and Load Plus Helper Springs

U-BOLTS MEASUREMENT REFERENCE

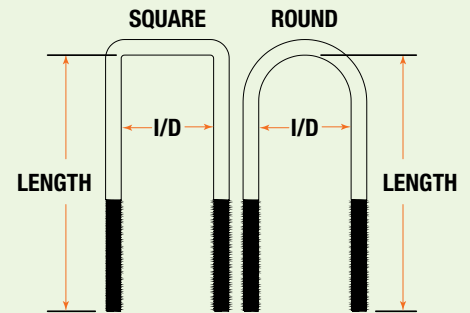

Part Number	Type	Length	I/D	Thread	Tension Nm
415UBK	Round	215	83	M14 X 1.5 X 100	125
416UBK	Round	230	83	M14 X 1.5 X 100	125
416UBKL	Round	250	83	M14 X 1.5 X 100	125
417UBK	Round	220	88	M14 X 1.5 X 80	125
436UBK	Square	230	73	M14 X 1.5 X 100	125
437UBK	Square	175	62	M14 X 1.5 X 100	125
437UBKL	Square	190	62	M14 X 1.5 X 100	125
449UBK	Square	230	83	M14 X 1.5 X 100	125
451UBK	Round	190	75	M12 X 1.5 X 75	75
452UBK	Square	120	63	M12 X 1.5 X 75	75
453UBK	Round	230	97	M14 X 1.5 X 100	125
512UBK	Round	160	70	M12 X 1.5 X 65	75
654UBK	Round	165	82	M12 X 1.5 X 75	75

Part Number	Type	Length	I/D	Thread	Tension Nm
655UBK	Round	140	70	M12 X 1.5 X 65	75
668UBK	Square	230	73	M14 X 1.5 X 100	125
669UBK	Square	230	73	M14 X 1.5 X 100	125
670UBK	Round	230	95	M14 X 1.5 X 100	125
678UBK	Square	200	62	M14 X 1.5 X 70	125
788UBK	Square	190	63	M12 X 1.25 X 65	75
1100UBK	Round	230	110	M14 X 1.5 X 100	125
1100UBKL	Round	265	110	M14 X 1.5 X 100	125
1102UBK	Square	155	72	M12 X 1.5 X 65	75
1103UBK	Round	185	72	M14 X 1.5 X 100	125
1104UBK	Round	200	83	M14 X 1.5 X 100	125
1106UBK	Square	205	92	M14 x 1.5 x 75	125

LOAD PLUS HELPER SPRINGS

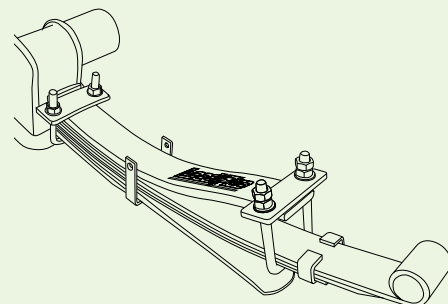

Part Number	Width	Thickness	Length	Mounting Kit	U-Bolt
LP1	60	12	425	LP3-1	LP3-2
LP2	60	12	420	LP3-1	LP3-2
LP3	60	12	442	LP3-1	LP3-2
LP4	70	12	442	LP4-1	LP4-2

Part Number	Width	Thickness	Length	Mounting Kit	U-Bolt
LP5	50	8	310	LP5-1	LP5-2
LP7	75	12	438	LP7-1	LP7-2
LP9	70	16	435	LP9-1	LP9-2

Suspension Arm Rubber Bush Kits

WITH STANDARD RADIUS ARM BUSHES

Model	Part Number	Contents	Position	Qty Per Kit
TO SUIT NISSAN PATROL Y60 GQ 1989 - On TO SUIT NISSAN PATROL Y61 GU WAGON Pre 2/2000	839RK	832RT	Radius Arm - Diff	4
		833R	Radius Arm Chassis	4
		836RT	Trailing Arm	8
		834RT	Panhard Rod - Chassis	2
		840RT	Panhard Rod - Diff	2
TO SUIT NISSAN PATROL Y61 GU WAGON 2/2000 - On	848RK	832RT	Radius Arm - Diff	4
		833R	Radius Arm Chassis	4
		836RT	Trailing Arm	8
		848RT	Panhard Rod - Chassis	2
		840RT	Panhard Rod - Diff	2
TO SUIT TOYOTA LANDCRUISER 80/105	847RK	832RT	Radius Arm - Diff	4
		846RT	Radius Arm Chassis	2
		844RT	Trailing Arm Upper	4
		843RT	Trailing Arm Lower	4
		841RT	Front Panhard Rod	2
		845RT	Rear Panhard Rod	2

WITH 2° OFFSET RADIUS ARM BUSHES

Model	Part Number	Contents	Position	Qty Per Kit
TO SUIT NISSAN PATROL Y60 GQ 1989 - On TO SUIT NISSAN PATROL Y61 GU WAGON Pre 2/2000	839CRK	1144R	Radius Arm - Diff Offset	4
		833R	Radius Arm Chassis	4
		836RT	Trailing Arm	8
		834RT	Panhard Rod - Chassis	2
		840RT	Panhard Rod - Diff	2
TO SUIT NISSAN PATROL Y61 GU WAGON 2/2000 - On	848CRK	1144R	Radius Arm - Diff Offset	4
		833R	Radius Arm Chassis	4
		836RT	Trailing Arm	8
		848RT	Panhard Rod - Chassis	2
		840RT	Panhard Rod - Diff	2
TO SUIT TOYOTA LANDCRUISER 80/105	847CRK	1144R	Radius Arm - Diff Offset	4
		846RT	Radius Arm Chassis	2
		844RT	Trailing Arm Upper	4
		843RT	Trailing Arm Lower	4
		841RT	Front Panhard Rod	2
		845RT	Rear Panhard Rod	2



STRUT COMPRESSOR

Part No. IBSC7600

Ironman 4x4 Strut Compressor

by **Branick**

Ironman 4x4 have teamed with Branick to bring you the industry leading 7600 model strut compressor. The 7600 is the top of the line strut compressor and provides a safe and efficient way to assemble and disassemble struts.

Key Features:

- *Increases workshop profitability*
- *Safer and easier than alternate methods*
- *Handles the heaviest 4WD struts*
- *Has long handles for extra torque*
- *Multi-position spring hooks*
- *Has a long compression stroke*
- *Does not require adapters*
- *Heavy duty acme thread*
- *Versatile mounting options*
- *All-steel construction*
- *Increase productivity*
- *Made in USA*



SAFER, STRONGER, SMARTER

+61 3 9532 1111
www.ironman4x4.com

FAQ / Troubleshooting

Can I assemble struts at home?

In most cases, no. Ironman 4x4 recommend strut assembly be performed only by a qualified automotive mechanic using specialised strut compressor equipment.

Assembled struts store large amounts of sprung energy. Only mechanics with necessary tools and equipment should attempt to disassemble or assemble a strut. Mishandling of strut assemblies can result in severe injury or death.

Never loosen or remove strut centre top nut until all spring energy is retained within a high quality strut compressor.

The shock absorber appears to be leaking.

Upon initial use, there may be an oily residue or a small amount of oil originating from the rod seal and surrounding parts, this is referred to as manufacturing overflow.

Oil can be trapped in the seal during assembly and released during transport or initial operation. This is considered normal and should be wiped clean prior to installation or after first use. If oil continues to appear, the shock absorber may be leaking and it should be replaced.

The shock absorber does not self-extend with gas pressure.

Ironman 4x4 Nitro Gas shock absorbers will self-extend due to pressurised nitrogen gas contained within, the rate of gas extension offers little relevance in determining the health or performance of the shock absorber.

Ironman 4x4 Foam Cell shock absorbers will NOT self-extend like a gas pressurised shock absorber as they do not contain gas pressure - A Foam Cell shock absorber will generally feel firmer to extend than it will to compress.

If a gas shock absorber fails to self-extend, this may not indicate a problem, it may simply be due to a dry or dirty piston rod, firm valving resistance or due to low gas pressure design. This does not adversely affect performance.

Avoid removing the thin film of oil from the piston rod, it is required for smooth seal operation and lubrication. A light oil may be used to rejuvenate the seal if a squeak is present.

The shock absorber appears damaged.

All Ironman 4x4 shock absorbers are twin tube construction, this means they are very resilient to damage from rocks and debris. The outer tube can tolerate dents providing no puncture exists, the shock absorber will still function as intended.

Do not allow mud or debris to accumulate for extended periods around suspension components, clean and rinse as soon as practical.

Dust shields or rubber protective boots are provided by Ironman 4x4 to protect the piston rod from rock and debris damage.

Spare parts such as bushes, boots and dust shields are often available as spare parts if required.

The lower strut bushes have perished.

This is most likely as a result of the bushes being tightened without neutralisation.

Never tighten shock absorber bushes until the vehicle is lowered to the ground.

Leave eye ring mounts finger tight ONLY, until the vehicle is lowered to the ground at normal ride height, failure to do this can damage the rubber bond due to twisting resulting in premature bush wear.

This is particularly important for load bearing lower strut bush applications.

Once the vehicle is lowered to the ground, only then tighten to specified tensions.

Can I re-use my original rubber spring bushes?

Ironman 4x4 always recommends to renew leaf spring bushes with polyurethane when new springs are fitted. The extended range of travel provided by Ironman leaf springs and longer shock absorbers can over-rotate and damage the rubber material. In all cases when a silent block press fit bush is used, it cannot be transferred to an Ironman 4x4 leaf spring.

Original two-piece rubber bushes will fit Ironman 4x4 leaf springs, however it is not recommended. When greased, polyurethane allows greater rotational freedom on the shackles pins when compared to rubber.

Does polyurethane require re-greasing?

Yes, polyurethane bushes should be re-greased as part of a regular maintenance schedule.

Ironman 4x4 recommend a Molybdenum Disulphide based grease or other grease specified for use with polyurethane.

Can I use Ironman 4x4 shock absorbers with original springs?

Yes, in all cases. (Except those specified for racing or offroad only applications such as 4" or 6" lift). Ironman 4x4 design all suspension components to be compatible with OEM suspension components.

For optimal performance, Ironman 4x4 do recommend Ironman 4x4 shock absorbers are fitted as part of an integrated suspension system comprising Ironman 4x4 springs.

Can I use Ironman 4x4 springs with original shock absorbers?

Yes, in all cases. (Except those specified for racing or offroad only applications such as 4" or 6" lift). Ironman 4x4 design all suspension components to be compatible with OEM suspension components.

For optimal performance, Ironman 4x4 do recommend Ironman 4x4 springs are fitted as part of an integrated suspension system comprising Ironman 4x4 shock absorbers.

The springs appear to be sagging.

Refer to completed installation form to measure and compare with new ride height.

Ironman 4x4 design an array of different springs to suit different load applications. It is imperative the correct spring is selected for the expected loads.

Installing a spring which is too soft for the load will result in loss of expected ride height. Installing a spring which is too strong for the load will result in excessive ride height.

To properly determine whether a spring has sagged or is under-specified, the spring must be removed from the vehicle and free height checked against the original specification found in suspension catalogue.

Depending on spring size and rate, a loss of up to 10mm due to natural steel relaxation is considered normal.

Natural settling is expected within the first 2-3 months, after which the springs are expected to maintain height.

If a spring has lost more than 10mm free height from new, they may require replacement.

FAQ / Troubleshooting

The vehicle is leaning to one side.

Refer to completed installation form to measure and compare with new ride height.

If a vehicle is leaning down on one corner, firstly ensure the vehicle is on level ground and then assess the weight distribution to ensure even placement of load and accessories.

Many vehicle models exhibit an uneven weight distribution from factory, Ironman 4x4 adjust the spring height accordingly to level the vehicle.

Check if springs are designated for Drivers Side (D/S) or Passengers Side (N/S) and ensure they are installed to the correct location.

Typically the taller coils should be fitted to the heavier side of the vehicle.

The vehicle is leaning towards front or back.

Refer to completed installation form to measure and compare with new ride height.

Typically if the vehicle is level from side to side, but down at front or back, indicates incorrect spring selection. Check springs are correctly specified to match the load and accessories.

Vehicles which feature independent suspension are generally subject to a 2:1 motion ratio, meaning that for every 1mm of movement at the spring, the ride height is affected 2mm.

This is particularly important when assessing spring settling or sag. Natural settling of 10mm at the spring will result in 20mm setting of ride height. Settling of new rubbers and bushes should also be factored as they will contribute a few additional mm.

The shock absorber feels too soft or inconsistent when compressed.

Prime the shock absorber by fully pumping it upright 2-3 times, ensuring the pressure chambers are fully purged of gas or air bubbles.

The shock absorber will generally feel firmer to extend than it will to compress.

The ride height is too high or banging over bumps.

Independent suspension operates with limited wheel travel. Ironman 4x4 design springs to increase the ride height a prescribed amount within the safe limits of the original vehicles design.

If incorrectly specified springs or additional spacers are fitted, the ride height may be excessive causing the strut to reach its upper limit "top out" during motion.

As a general rule, Ironman 4x4 recommend a MINIMUM of 60mm downward travel available in the suspension, otherwise referred to as "droop".

To establish ride height in relation to maximum height, a droop measurement will be required.

DROOP MEASUREMENT

- 1) Measure and record the vertical rim to guard distance with the vehicle on flat level ground.
- 2) Raise and support the vehicle with front or rear wheels hanging.
- 3) Measure and record the vertical rim to guard distance with the wheels fully hanging.

The difference between the two measurements is the amount of downward droop the suspension has available to it.

The minimum droop distance should be no less than 60mm fully settled.

If droop is less than 60mm, a reduction in handling performance will be experienced, possibility of damage to suspension, driveline and tyre wear can be a factor. In this case the ride height must be lowered.

There is a squeak coming from the suspension.

A squeak can originate from any number of sources or for many reasons. The most effective method to diagnose and resolve a squeak is to perform a systematic approach to locating the source. Make note of what conditions cause the squeak, ie. large bumps, small bumps, wet weather, cornering etc. Also note the type of noise whether it appears to be from a soft rubber / plastic origin or hard steel origin.

Attempt should be made to simulate the condition, such as bouncing the vehicle whilst listening to locate the source, it may be required to enlist a second person to bounce the vehicle whilst another accesses the underneath of the vehicle closely to pin point the exact location.

Typical sources for noise include:

- Dry or broken bushes
- Loose or misaligned components
- Bent or damaged components
- Steel to Steel friction
- Under-tensioned bolts

The suspension appears to be rusty.

In many cases, damage to spring or shock absorber coating is unavoidable due to impacts with stones and debris. In some instances light surface rusting may appear on exposed steel if coating becomes damaged. This will not affect the performance of the product however may be unsightly. Take care when using a high pressure washer or strong chemicals during cleaning as this can further compromise the coating leading to greater exposure.

Care should be taken during installation to ensure components are not scratched or damaged which may result in exposure of the underlying steel.

Vehicles operating in salty environments may experience further accelerated surface rusting.

There is a vibration after fitting the suspension.

This is a known issue in some vehicles after ride height has been raised. It is caused by the change in angle within the driveline, most commonly in vehicles with 2 piece driveshafts.

In many cases where vibration is a common factor, Ironman 4x4 offer a solution such as a driveline spacer kit to adjust the angles of the driveshaft. The spacer kits are used to adjust the location of the centre bearing with view to reduce the vibration to a satisfactory level.

Each vehicle can vary in severity, some may not be fully rectified after the re-alignment. In such cases axle wedges or a reduction in ride height may be required.

Can I adjust the strut seat height?

Ironman 4x4 struts feature an adjustable height spring seat. 12xxx & 24xxx series struts utilise a trim packer system, 45xxx series struts utilise a threaded strut body.

Seat height cannot be adjusted whilst in vehicle, strut must be removed from vehicle with spring tension unloaded to enable adjustment.

The purpose of this adjustment feature is to allow recalibration of ride height following the installation of heavy accessories or to compensate spring settling.

Not to be used as a variable ride height system.

An increase in seat height beyond OEM specifications may result in excessive lift and non-compliance to state or federal laws.

A minimum 60mm suspension droop must be available at all times.



Impossible is for the unwilling!



for a full range of accessories visit our website

www.ironman4x4.com



Accessories Selection and Information

Effective 1 May 2021



Features and Benefits

COMMERCIAL BULL BAR



Australian Designed and Engineered.

Styled around the contours of the vehicle.

Tested in Australia and complies to ADRs and airbag compatibility.

Designed to ensure maximum strength, protection and improved approach angle.

Winch compatible on separate winch cradle removing excess weight off the bar and reducing weight on the front suspension.

An improved level of occupant safety from animal strikes.

Made using the highest quality SPHC oil and pickled steel.

Robot welded together for ultimate strength and accuracy.

Bar comprises of the following features

A-Frame 50mm triple loop design, integrated LED parker and indicator, high lift jack points, aerial tab. Driving light mounting locations. Reinforced front centre and side wing for protection.

The Ironman 4x4 commercial bar is perfect for the customer who wants maximum protection without the option of fog lights. Perfect for the avid 4wder, daily driver or fleet buyer.

COMMERCIAL DELUXE BULL BAR



Australian Designed and Engineered.

Styled around the contours of the vehicle.

Tested in Australia and complies to ADRs and airbag compatibility

Designed to ensure maximum strength, protection and improved approach angle.

Winch compatible on separate winch cradle removing excess weight off the bar and reducing weight on the front suspension.

An improved level of occupant safety from animal strikes.

Made using the highest quality SPHC oil and pickled steel.

Robot welded together for ultimate strength and accuracy.

Bar comprises of the following features

A-Frame 50mm triple loop design, integrated LED parker and indicator, fog light and loom, high lift jack points, aerial tab. Driving light mounting locations. Reinforced front centre and side wing for protection.

The Ironman 4x4 commercial deluxe bar is perfect for the customer who wants maximum protection with the option of a fog lights. Perfect for owner wanting a more styled protective option whilst maintaining or adding fog lights.

PROTECTOR BULL BAR



Australian Designed and Engineered.

Styled around the contours of the vehicle.

Tested in Australia and complies to ADRs and airbag compatibility.

Designed to ensure maximum strength, protection and improved approach angle.

Winch compatible on separate winch cradle removing excess weight off the bar and reducing weight on the front suspension.

An improved level of occupant safety from animal strikes.

Made using the highest quality SPHC oil and pickled steel.

Robot welded together for ultimate strength and accuracy.

Bolt on 304 stainless steel loops.

Bar comprises of the following features

Bolt on triple loops 75mm centre and 50mm outer loops, integrated LED parker and indicator, fog light and loom, high lift jack points, aerial tab. Driving light mounting locations. Reinforced front centre and side wing for protection.

The Ironman 4x4 protector bar is perfect for the customer who wants maximum protection with the option of a fog lights and with the shine of stainless steel loops. Perfect for owner wanting a to match the chrome highlights on their vehicle whilst maintaining protection.

PROGUARD NO LOOP BULL BAR



Australian Designed and Engineered.

Styled around the contours of the vehicle.

Tested in Australia and complies to ADRs and airbag compatibility

Designed to ensure maximum strength, protection and improved approach angle.

Winch compatible on separate winch cradle removing excess weight off the bar and reducing weight on the front suspension.

An improved level of occupant safety from animal strikes.

Made using the highest quality SPHC oil and pickled steel.

Robot welded together for ultimate strength and accuracy.

Features no loops for a bumper replacement look.

Bar comprises of the following features

Lower bull bar section only, integrated LED parker and indicator, fog light and loom, high lift jack points, Driving light mounting locations. Reinforced front centre and side wing for protection.

The Ironman 4x4 proguard bar is perfect for the customer who wants some protection with the option of a fog lights but without the addition of full loops. Single or triple stainless-steel loops can be added for increased protection. Perfect for owner wanting a look of a bumper replacement bar but with the option to add to the bar with different loops.

Features and Benefits

PREMIUM COMMERCIAL DELUXE BULL BAR



Australian Designed and Engineered.

Styled around the contours of the vehicle.

Tested in Australia and complies to ADRs and airbag compatibility.

Designed to ensure maximum strength, protection and improved approach angle.

Winch compatible on separate winch cradle removing excess weight off the bar and reducing weight on the front suspension.

An improved level of occupant safety from animal strikes.

Made using the highest quality SPHC oil and pickled steel.

Robot welded together for ultimate strength and accuracy.

Designed for the larger 4wds.

Bar comprises of the following features

A-Frame 60mm triple loop design, integrated LED parker and indicator, metal fog light surround with fog lights and loom, high lift jack points, 3 aerial tabs. Driving light mounting locations. Reinforced front centre and side wing for protection.

The Ironman 4x4 Premium deluxe bar is perfect for the customer who wants maximum protection with the option of a fog lights. Perfect for owner of a larger 4wd wanting a more protection coverage and a larger tube size.

POLISHED ALLOY BULL BAR



Australian Designed and Engineered.

35% less weight than steel bull bar.

Styled around the contours of the vehicle.

Tested in Australia and complies to ADRs and airbag compatibility

Designed to ensure maximum strength, protection and improved approach angle.

Winch compatible on separate winch cradle removing excess weight off the bar and reducing weight on the front suspension.

An improved level of occupant safety from animal strikes.

Made using the highest quality 5052 Aluminium.

Welded together for ultimate strength and accuracy.

Bar comprises of the following features

Triple loops 75mm centre and 50mm outer loops, integrated LED parker and indicator, fog lights and loom, 2 aerial tabs. Driving light mounting locations. Reinforced front centre and side wing for protection.

The Ironman 4x4 Polished alloy bar is perfect for the customer who wants maximum protection with advantage of less weight. The Polished alloy bar weighs 35% less when compared to steel bars.

PROGUARD SINGLE OR TRIPLE LOOP



Add to the Proguard no loop bull bar for increased protection, style and for aesthetics.

75mm 304 stainless steel tubing centre loop can be added for added styling to complement any vehicle and increase protection in the centre of the vehicle.

The triple loop design is made up of 75mm centre loops with 50mm outer loops out of 304 stainless steel. The triple loops can be added for added styling to complement any vehicle and increase protection across the full front of the vehicle.

Includes

Centre loop bar and overriders.

RECOVERY POINTS



A rated recovery point is an essential accessory for any 4wd. Designed in Australia tested and approved to ensure the safest connection point on the vehicle for a recovery.

Designed using 12mm steel with elongated hole to allow a rated shackle or soft shackle to pass through, allowing the strap to be on the correct angle.

Powder coated Red for quick and easy identification with safety instructions on each point. Rated at 5000kgs, the rated recovery points can be used with an equalisation strap allowing load distribution across both points.

SIDE STEPS



Side steps provide a stronger step option that bolt to the chassis and not the body. The steel steps Allows for easy access to vehicle.

Premium Steel Construction - Made from the highest quality SPHC oil and pickled steel for maximum strength and resistance to rust.

Heavy duty black powder coated checkerplate tread is not only stylish, but practical and durable.

Newer Hybrid Design - Allows for the addition of side rails at a later point

Can be colour coded to match vehicle paint colour.

SIDE RAILS



Designed to be added to the Ironman 4x4 side step range for complete sill, door and panel protection.

Premium Steel Construction - Made from the highest quality SPHC oil and pickled steel for maximum strength and resistance to rust.

Heavy duty black powder coating is practical and durable, or can be colour coded to match vehicle paint colour. Easily attach to Ironman 4x4 hybrid side steps and most bull bars on the market.

Features and Benefits

SNORKELS

Snorkels provide cleaner, dryer and cooler air to the vehicles engine. By raising the height of the vehicles air intake, this also allows for safer water crossings. The ram head forces air into the airbox and deflects any rain, forcing the rain to the outer edges, allowing the rain to exit at the head level and not enter the airbox.



Heavy Duty Construction - Made from the highest quality LLDPE and has the highest UV rating for harsh outback environments.

3D Scanned and Designed - Ensures the snorkel complements the contour lines of your vehicle.

CANVAS SEAT COVERS

Tailored - Comfort canvas seat covers to suit most off-road vehicles



Highest quality manufacturing - Made from 12oz, 100% cotton natural fibre canvas that is water, mud and fire resistant

Cushioning Foam - Adds an extra level of - Comfort with the added extra layer of cushioning foam whilst providing an air gap to keep cooler

100% Airbag Deploy Safe - Employs the use of a special thread and controlled stitching process to ensure compliance.

Built-in - Map pockets and lumbar support control access.

WINCHES

Australian engineer, designed and tested.



Designed to suit all Ironman 4x4 Bull Bars as well as most winch compatible bull bars on the market.

9,500lb or 12,000lb options, available with synthetic rope or steel cable.

High speed balanced motor with sealed bearings and fully sealed style solenoid. Repositionable clutch handle. IP68 rated with external remote breather. Integrated anti-tamper power cut off and an all in one wireless/plug in controller with LED torch.

LED LIGHTS

Available in a range of Driving Light or Light Bar styles to suit most end user requirements.



See page 23-26 for different styles, or page 434-435 for technical specifications and product comparison.

DC TO DC BATTERY CHARGERS

Made in Australia, the 40 amp DC to DC charger is suitable for 12 volt vehicle and trailer systems. The DC to DC unit also works with standard or variable/smart alternators. 3-stage 12V booster charger. Remote charge status LED indicator. Very low standby current <3mA.



Optional start assist kit, assists to start the car when the main battery is flat and also can boost charge amperage output to 80Amp max.

ELECTRIC BRAKE CONTROLLER

Easily adjust the strength of the brakes on your trailer when towing.



Easy adjustment dashboard dial. Remote hideaway control box. Mountable at any angle. Push button override function. Dual axle capability.

Compatible with ESC, single and dual axle trailers

Alko Approved unit.

REAR TOW BARS

Australian Designed and developed to suit 4x4 vehicles with factory bumpers.



Dynamic and static testing to 3500kg. Comes complete with tow hitch, pin and 3500kg rated 50mm tow ball.

REAR PROTECTION TOW BARS

Designed for complete vehicle rear protection.



Meets ADR and Australian towing standards. Side rear quarter protection. 4mm steel construction with 8mm tow bar sub frame. Protected location for anderson and trailer plug. LED numberplate lights. Dynamic and static testing to 3500kg. Comes complete with tow hitch, pin and 3500kg rated 50mm tow ball.

ABS CANOPIES

Heavy duty 9mm smooth finish ABS Plastic construction with an in-built metal supporting frame.



Marine carpet lined. Colour coded options or can be matched to suit vehicle colour. Rear LED stop light on some models. Plug and play wiring loom. Internal clamps. Internal light and front sliding window. Lockable tinted lift up windows with gas struts. Central locking available for some models.

Features and Benefits

PINNACLE CANOPIES

Heavy duty smooth finish vinyl ester fiberglass construction with a reinforced structural frame.



Colour coded options or can be matched to suit vehicle colour. Roof rails. Internal battery operated light. Internal front sliding window. Lockable tinted lift up windows with gas struts. Central locking.

SINGLE AND TWIN DRAWER SYSTEMS

Available as a single or double drawer option. Wing kits available to suit twin drawer systems.



Complies to ADR. Comes fully assembled. 100kg rating per drawer. Galvanised steel construction lined with marine grade carpet. T-Lock lockable handles. Child seat restraint points.

LONG RANGE FUEL TANKS

Designs to suit a wide range of models, with capacities of up to 160L.



2mm aluminised steel with a black powdercoat finish. 5 day pressure tested. Internal baffles.

ICE CUBE FRIDGE / FREEZERS

SECOP Compressor. Electronically controlled. Low energy consumption. 3 year components warranty. 5 year compressor warranty. Fridge or freezer functionality (65L has both).



ROOFTOP TENTS

Premium 280gsm Ripstop poly cotton canvas.



Waterproof and breathable "Climate cover" flysheet controls temperature and reduces condensation. All openings with insect mesh and internal covers.

65mm high density luxury foam mattress. Heavy duty 1000D waterproof cover. Lightweight aluminium and insulated floor. Heavy duty YKK zips.

Add on Annex options are also available to complement this unit.

AWNINGS

Available in a range of widths and lengths. Please see page 21 for details and other add on options that are also available.



Premium 280gsm Ripstop UV50+ rated poly cotton canvas. Flexible nylon joints. Twist lock poles. Integrated LED light strip with dimmer. Reflective guy ropes. 1000D PVC cover. Room enclosure and flyscreen netting room available as an add on. Now also available are the new awning room and Awning Xtra Weathershield.

STEEL ROOF RACKS

Available in a range of styles and sizes, please see page 34 for variations.



Strong steel construction.

Spare wheel mount on Cage and Trade style racks.

Durable black powdercoated finish. Heavy duty reinforced mesh flooring. Wind noise reducing air deflector plate.

Roof rack mounting kits also available, sold separately.

ALLOY ROOF RACKS

Available in a range of styles and sizes, please see page 33 for variations.



Up to 60% lighter than steel roof racks.

Lightweight but strong alloy construction.

Durable gunmetal grey powdercoated finish. Heavy duty reinforced aluminium mesh flooring. Wind noise reducing air deflector plate.

Roof rack mounting kits also available, sold separately.

UNDERBODY PROTECTION

Safeguard against off-road damage from rocks, stumps and ground strikes. Available in IUP or UBP series.



See vehicle listings to see options available for each vehicle.

IUP Series

2.5-3mm pressed and folded steel.
Easy bolt-on installation.
Semi-gloss black powdercoated finish.

UBP Series

4mm fabricated steel.
Recessed hardware and integrated framework.
5 x impact resistance.
Airflow ventilation channels and service inspection holes.
Textured black powdercoated finish and anti-corrosion coating.



If you can dream it, you can do it!



for a full range of accessories visit our website

www.ironman4x4.com



Accessories Specifications

Effective 1 May 2021



Winches and Bull Bars

MONSTER WINCHES

Part Number	Capacity	Description	Weight
WWB9500	9500lb	With Steel Cable and Wireless Plug in Controller	N.W 42kg (90lb)
WWB12000	12000lb	With Steel Cable and Wireless Plug in Controller	N.W 44kg (98lb)
WWB9500SR	9500lb	With Synthetic Rope and Wireless Plug in Controller	N.W 28kg (62lb)
WWB12000SR	12000lb	With Synthetic Rope and Wireless Plug in Controller	N.W 29kg (64lb)

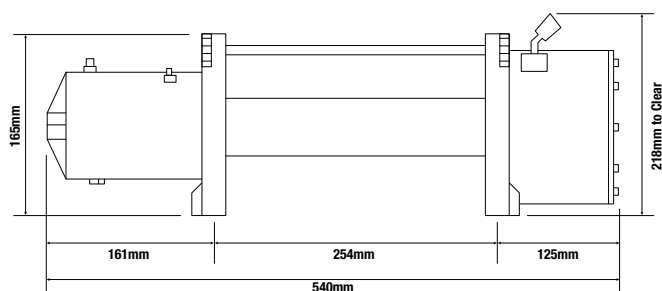

SIDE VIEW

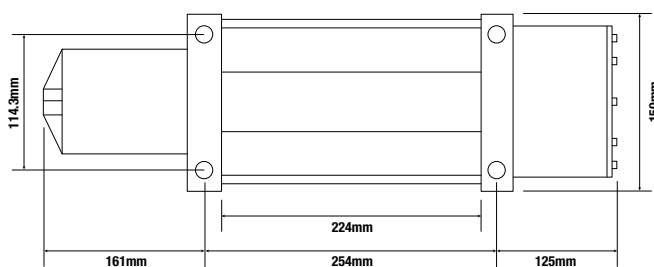

BOLTING PATTERN

BULL BARS

IMPORTANT: IRONMAN 4x4 BULL BARS CONFORM TO AUSTRALIAN STANDARDS AS47861.1/2002

- Scanned in 3D to ensure a correct and accurate fit with a stylish, but dependable design
- Ironman 4x4 bull bars are tested for ADR, Airbag compliance and compatibility with vehicle safety systems
- Made from the highest quality of SPHC oil and pickled steel (not mild steel) for maximum strength and highest resistance to rust
- Ironman 4x4 bull bars are CNC laser cut, bent and robot welded for optimum accuracy and finish
- Ironman 4x4 designed and engineered to ensure Airbag compatibility
- Winch compatible and use a unique mounting cradle to remove excess weight from the bull bar
- Black powdercoating using AKZO NOBEL powder (YN100G) allows a thicker, smoother and more durable coating
- Ironman 4x4 designed aerial mount for quick installation and removal of an aerial
- Integrated spot light or light bar mounts



360° ROBOT WELDS



FOG LIGHTS



**LED PARKER /
INDICATOR LIGHTS**



**SPOT OR LIGHT BAR
MOUNTS**



AERIAL MOUNT

Bull Bars

COMMERCIAL

BBC

- ADR 69, 73 approved
- Air bag tested and certified
- Winch compatible
- Aerial mount
- Steel construction
- A-Frame triple loop design
- Tough polyurethane bumpers
- LED parker / indicator included



COMMERCIAL DELUXE

BBCD

- ADR 69, 73 approved
- Air bag tested and certified
- Winch compatible
- Aerial mount
- Steel construction
- A-Frame triple loop design
- Tough polyurethane bumpers
- Fog lights (55W H3)
- LED parker / indicator included



PROTECTOR

BBT

- ADR 69, 73 approved
- Air bag tested and certified
- Winch compatible
- Aerial mount
- Steel construction
- Stainless steel triple loop design
- Tough polyurethane bumpers
- Fog lights (55W H3)
- LED parker / indicator included



POLISHED ALLOY

BBA

- ADR 69, 73 approved
- Air bag tested and certified
- Winch compatible
- Aerial mount
- 5mm aluminium frame
- 5mm sub frame
- 35% lighter than steel
- A-Frame triple loop design
- Tough polyurethane bumpers
- LED parker / indicator included



PREMIUM COMMERCIAL DELUXE

BBP

- ADR 69, 73 approved
- Air bag tested and certified
- 60.3mm steel tube construction
- Winch compatible
- Aerial mount
- A-Frame triple loop design
- Tough polyurethane bumpers
- Fog lights (55W H3)
- LED parker / indicator included



PROGUARD NO LOOP

BBT

- ADR 69, 73 approved
- Air bag tested and certified
- Winch compatible
- Steel construction
- Tough polyurethane bumpers
- Fog lights (55W H3)
- LED parker / indicator included
- Single or triple loop options available



Panel Protection and Recovery

Bull Bars, Rear Tow Bars, Side Steps / Rails and Recovery Points

TO SUIT VEHICLE MAKE AND MODEL	Commercial	Commercial Deluxe	Protector	Polished Alloy	Proguard No Loop ³	Premium / Special	Recovery Points	Tow Bars	Rear Step Tow Bars	Side Steps and Rails	Side Steps	Side Rails	Page
Approximate Weight	86kg	86 kg	82kg	62kg	75kg	92kg	-	30kg	69kg	53kg	40kg	13kg	
Tube Diameter	51mm	51mm	51mm	51mm	-	60.3mm	-	-	-	51/60.3mm	51/60.3mm	51/60.3mm	
To Suit Fiat Fullback 2016+	BBC050	BBCD050		BBA050	BBT050-NL		IRP050	TB050	RTB050	SSR050	SS050	SS050 RAIL	41
To Suit Ford Maverick 1988-1994 (See Nissan GQ Patrol)		BBCD010											216
To Suit Ford Ranger Raptor 2018+									RTB069				45
To Suit Ford Ranger PX Mk III 8/2018+ WITH or WITHOUT Tech Pack Adaptive Cruise Control (CC)		BBCD066*			BBT066-NL*		IRP054	TB038	RTB038	SSR054	SS054	SS054 RAIL	46
To Suit Ford Ranger PX Mk III 8/2018+ WITHOUT Tech Pack Adaptive CC With Sensor Provisions	BBC055	BBCD055					IRP054	TB038	RTB038	SSR054	SS054	SS054 RAIL	46
To Suit Ford Ranger PX Mk II 2015-7/2018 WITH or WITHOUT Tech Pack Adaptive Cruise Control (CC)		BBCD054			BBT054-NL		IRP054	TB038	RTB038	SSR054	SS054	SS054 RAIL	50
To Suit Ford Ranger PX Mk II 2015-7/2018 WITHOUT Tech Pack Adaptive CC With Sensor Provisions	BBC055	BBCD055					IRP054	TB038	RTB038	SSR054	SS054	SS054 RAIL	50
To Suit Ford Ranger PX 9/2011-2015	BBC038	BBCD038		BBA038	BBT038-NL		IRP054	TB038	RTB038	SSR054	SS054	SS054 RAIL	54
To Suit Ford Ranger PJ / PK 2007+ ²		BBCD014	BBT014							SSR002	SS008		58
To Suit Ford Everest AU II 7/2018+ WITH or WITHOUT Tech Pack Adaptive Cruise Control (CC)		BBCD066*			BBT066-NL*		IRP054			SSR055	SS055	SS055 RAIL	61
To Suit Ford Everest AU II 7/2018+ WITHOUT Tech Pack Adaptive CC With Sensor Provisions	BBC055	BBCD055					IRP054			SSR055	SS055	SS055 RAIL	61
To Suit Ford Everest 2015-6/2018 WITH or WITHOUT Tech Pack Adaptive Cruise Control (CC)		BBCD054			BBT054-NL		IRP054			SSR055	SS055	SS055 RAIL	63
To Suit Ford Everest 2015-6/2018 WITHOUT Tech Pack Adaptive CC With Sensor Provisions	BBC055	BBCD055					IRP054			SSR055	SS055	SS055 RAIL	63
To Suit Holden Trailblazer LT / LTZ 11/2017+	BBC057	BBCD057			BBT057-NL		IRP057 IRP058			SSR044	SS044	SS044 RAIL	70
To Suit Holden Colorado RG 11/2016-2020	BBC057	BBCD057			BBT057-NL		IRP057 IRP058	TB040	RTB040	SSR057	SS057	SS057 RAIL	74
To Suit Holden Colorado RG 2012-10/2016	BBC040	BBCD040					IRP058	TB040	RTB040	SSR057	SS057	SS057 RAIL	77
To Suit Holden Colorado 7 RG 2012+		BBCD044	BBT044				IRP058			SSR044	SS044	SS044 RAIL	72
To Suit Holden Colorado RC 7/2008-12/2012 ^{1,2}		BBCD027	BBT027							SSR006	SS001		81
To Suit Holden Rodeo RA7 2007-7/2008	BBC020	BBCD020	BBT020							SSR006	SS001		83
To Suit Holden Rodeo RA 2002-2006 ²		BBCD003								SSR006	SS001		85
To Suit Isuzu D-MAX 8/2019+		BBCD074			BBT074-NL		IRP074		RTB074	SSR074	SS074	SS074 RAIL	90
To Suit Isuzu D-MAX 2/2017-7/2019 (Will not fit narrow body)	BBC058	BBCD058	BBT058		BBT058-NL		IRP058	TB041	RTB041	SSR057	SS057	SS057 RAIL	93
To Suit Isuzu D-MAX 6/2012-1/2017	BBC041	BBCD041	BBT041				IRP058	TB041	RTB041	SSR057	SS057	SS057 RAIL	96
To Suit Isuzu D-MAX 2007-6/2012 ²	BBC020	BBCD020	BBT020							SSR006	SS001		100
To Suit Isuzu MU-X 3/2017+		BBCD061			BBT061-NL		IRP058			SSR044	SS044	SS044 RAIL	102
To Suit Isuzu MU-X 2014-2/2017		BBCD049	BBT049				IRP058			SSR044	SS044	SS044 RAIL	102
To Suit Jeep Gladiator JT 4/2019+	BBR077 - (Raid Full Length Bumper)			BBR077ST - (Raid Stubby Bumper)					RTB077JT		SS077JT		110
To Suit Jeep Grand Cherokee WK2 2013+		BBCD052											112
To Suit Jeep Wrangler JL (4 Door) 2018+	BBR077 - (Raid Full Length Bumper)			BBR077ST - (Raid Stubby Bumper)				TB077JL	RTB077JL		SS077JL		116
To Suit Jeep Wrangler JK 2007+	BBR077	BBCD035		BBR077ST				TB077JL					118
To Suit Land Rover Defender 2007-2016	BBC023												125
To Suit LDV T60 2017+		BBCD068*											134
To Suit Mazda BT50 6/2020		BBCD080			BBT080-NL				RTB080	SSR080	SS080	SS080 RAIL	139
To Suit Mazda BT50 2012-5/2020 ²	BBC039	BBCD039			BBT039-NL		IRP054	TB038	RTB038	SSR039	SS039		142
To Suit Mazda BT50 J97M 2006-2011 ^{1,2}	BBC024	BBCD024	BBT024							SSR007	SS009		146
To Suit Mitsubishi Pajero Sport 7/2019+		BBCD079*			BBT079-NL*		IRP059			SSR079	SS079	SS079 RAIL	154
To Suit Mitsubishi Pajero Sport 11/2016-6/2019 (GLX +GLS only)		BBCD059*			BBT059-NL*		IRP059				SS059		156
To Suit Mitsubishi Pajero NW 2011-NX	BBC045	BBCD045											158
To Suit Mitsubishi Pajero NS & NT 5/2000-2011	BBC045	BBCD045											159
To Suit Mitsubishi Triton MR (GLS Model) 11/2018+		BBCD067*			BBT067-NL*		IRP059	TB050	RTB067GLS	SSR050	SS050	SS050 RAIL	170
To Suit Mitsubishi Triton MR (Non-GLS Model) 11/2018+		BBCD067*			BBT067-NL*		IRP059	TB050	RTB067GLX	SSR050	SS050	SS050 RAIL	170
To Suit Mitsubishi Triton MQ 2015-10/2018	BBC050	BBCD050		BBA050	BBT050-NL		IRP050	TB050	RTB050	SSR050	SS050	SS050 RAIL	174
To Suit Mitsubishi Triton MN 2009-2015 ^{1,2}	BBC031	BBCD031	BBT031							SSR031	SS031		179
To Suit Mitsubishi Triton ML 2006-2009 ^{1,2}	BBC016	BBCD016	BBT016							SSR031			182
To Suit Nissan Navara NP300 2015+	BBC048	BBCD048		BBA048	BBT048-NL		IRP005	TB048	RTB048	SSR048	SS048	SS048 RAIL	188
To Suit Nissan Navara D40 ² (Does not suit 2010+ STX - Spain Build)		BBCD012	BBT012				IRP005			SSR003	SS007		191
To Suit Nissan Navara D40 V6 2010+ STX ²		BBCD042	BBT042				IRP005			SSR042	SS042		191
To Suit Nissan Navara D22 2002+ ^{1,2}		BBCD013	BBT013										194

Panel Protection and Recovery

TO SUIT VEHICLE MAKE AND MODEL	Commercial	Commercial Deluxe	Protector	Polished Alloy	Proguard No Loop ³	Premium / Special	Recovery Points	Tow Bars	Rear Step Tow Bars	Side Steps and Rails	Side Steps	Side Rails	Page
Approximate Weight	86kg	86 kg	82kg	62kg	75kg	92kg	-	30kg	69kg	53kg	40kg	13kg	
Tube Diameter	51mm	51mm	51mm	51mm	-	60.3mm	-	-	-	51/60.3mm	51/60.3mm	51/60.3mm	
To Suit Pathfinder R51 2005-2013		BBCD012	BBT012										198
To Suit Nissan Pathfinder R51 2010+		BBCD042	BBT042										198
To Suit Nissan Patrol Y62 2010-2019						BBP062							204
To Suit Nissan Patrol Y61 GU Series 4 2005+ ¹ (Coil Spring Only)			BBT011			BBP011	IRP005			SSR012/ SSRP011	SS012		206
To Suit Nissan Patrol Y61 GU Series 1-3 1998-2004 ¹ (Coil Spring Only)		BBCD009					IRP005			SSR012	SS012		207
To Suit Nissan Patrol Y60 GQ 1987-1997 ¹ (Coil Spring Only)	BBC010	BBCD010											216
To Suit Renault Alaskan 2017+ (Thai Built Only)	BBC048	BBCD048		BBA048	BBT048-NL			TB048	RTB048	SSR048	SS048	SS048 RAIL	228
To Suit SsangYong Musso Q200 / Q201 / Q205 10/2018+		BBCD071*											231
To Suit SsangYong Rexton Y400 10/2018+		BBCD071*											236
To Suit Suzuki Jimmy GJ 2019+		BBCD070*				BBS070*	IRP070						242
To Suit Suzuki Jimmy 2012-2018		BBCD063*											244
To Suit Suzuki Grand Vitara 2012+ (Diesel Manual Only)		BBCD046	BBT046										248
To Suit Toyota 4Runner Gen 5 N280 2009+		BBR078 - (Raid)							RTB078		SS078		252
To Suit Toyota FJ Cruiser 2006+		BBCD037											258
To Suit Toyota Fortuner 2020+ (facelift)		BBCD081			BBT081-NL		IRP051			SSR053	SS053	SS053 RAIL	260
To Suit Toyota Fortuner 2015-9/2020		BBCD053	BBT053		BBT053-NL		IRP051			SSR053	SS053	SS053 RAIL	260
To Suit Toyota Fortuner 2004-2015	BBC030	BBCD030	BBT030		BBT030-NL								262
To Suit Toyota Hilux 8/2020+		BBCD076 BBCD076-NB			BBT076-NL		IRP051	TB051	RTB051-SP	SSR051	SS051	SS051 RAIL	266
To Suit Toyota Hilux Revo 5/2018-7/2020	BBC065	BBCD065		BBA065	BBT065-NL		IRP051	TB051	RTB051-P	SSR051	SS051	SS051 RAIL	270
To Suit Toyota Hilux Revo 2015-4/2018	BBC051	BBCD051		BBA051	BBT051-NL		IRP051	TB051	RTB051-P	SSR051	SS051	SS051 RAIL	270
To Suit Toyota Hilux Vigo 10/2011-2015 ¹	BBC033	BBCD033	BBT033				IRP033			SSR033	SS033		274
To Suit Toyota Hilux Vigo 3/2005-9/2011 ¹	BBC002	BBCD002	BBT002				IRP033			SSR033	SS033		274
To Suit Toyota Hilux Tiger 1997-2004 IFS ¹		BBCD001											278
To Suit Toyota Landcruiser 200 Series 11/2015+	BBC056			BBA056-VX	BBT-056VX-NL*	BBP056-VX*	IRP056			SSRP056	SSP056	SSP056 RAIL	283
To Suit Toyota Landcruiser 200 Series / Lexus LX570 11/2007-1/2012						BBP025	IRP056						286
To Suit Toyota Landcruiser 200 Series / Lexus LX 570 2/2012-10/2015	BBC043		BBT043			BBP043	IRP056						286
To Suit Toyota Landcruiser 105 Series 3/1998-10/2007		BBCD005					IRP005						288
To Suit Toyota Landcruiser 100 Series IFS / Lexus LX470 3/1998-10/2007		BBC006					IRP005						291
To Suit Toyota Landcruiser 80 Series / Lexus LX 450 1990-1998 ¹		BBCD004					IRP005						293
To Suit Toyota Landcruiser 79 Series Single Cab 9/2016+ ¹	BBC019SC		BBT019SC			BBP019SC	IRP019SC			SSR019SC/ SSRP019SC	SS019SC / SSP019SC	SSR019SC RAIL/ SSRP019SC RAIL	296
To Suit Toyota Landcruiser 79 Series Single Cab 2007-8/2016 ¹	BBC019E		BBT019E			BBP019E				SSR016 / SSRP016	SS016		296
To Suit Toyota Landcruiser 79 Series Dual Cab 11/2012+ ¹	BBC019E		BBT019E			BBP019E	IRP019			SSR019 / SSRP019	SS019		299
To Suit Toyota Landcruiser 78 Series Troop Carrier 2007+ ¹	BBC019E		BBT019E			BBP019E	IRP019						303
To Suit Toyota Landcruiser 78 Series Troop Carrier 1999-2007+ ¹	BBC018	BBCD018											307
To Suit Toyota Landcruiser 76 Series 2007+ ¹	BBC019E		BBT019E			BBP019E	IRP019			SSR015 / SSRP015	SS015		311
To Suit Toyota Landcruiser 75, 78, 79 Series 1984-2007	BBC018	BBCD018											296, 307, 314
To Suit Toyota Prado 150 Series Facelift 11/2017+					BBT064-NL*	BBP064*	IRP064			SSRP064	SSP064	SSP064 RAIL	328
To Suit Toyota Prado 150 Series 10/2013-10/2017	BBC047	BBCD047		BBA047			IRP064			SSR047	SS047		331
To Suit Toyota Prado 150 Series 11/2009-10/2013	BBC029	BBCD029	BBT029				IRP064			SSR047	SS047		331
To Suit Toyota Prado 120 Series 4/2003-10/2009 ¹		BBCD008	BBT008							SSR004	SS017		334
To Suit Toyota Prado 90, 95 Series 1996-10/2002 ¹		BBCD007											336
To Suit Toyota Tacoma 2005+	BBR072								RTB072		SS072		338
To Suit Toyota Tundra 2013-2020	BBR073								RTB073		SS073		340
To Suit Volkswagen Amarok V6 / 4 Cyl 11/2016+	BBC060	BBCD060			BBT060-NL				RTB060	SSR034	SS034	SS034 RAIL	346
To Suit Volkswagen Amarok 2011-10/2016	BBC034	BBCD034	BBT034						RTB060	SSR034	SS034	SS034 RAIL	348

NOTES: ¹ Suits flared guard model. ² Suits both 2WD and 4WD models. ³ Single and triple loop options available. * Only compatible with Synthetic Rope Winch and Alloy Hawse.



Snorkels

SNORKELS

Vehicle Make	Model and Specifics	Part Number	Page
To Suit Fiat Fullback	2016+	ISNORKEL050	41
To Suit Ford Maverick	1988-1994 - (All models except 2.8L Diesel)	ISNORKEL011	216
To Suit Ford Ranger	PX III XL 8/2018+ 3.2L Diesel	ISNORKEL034	46
To Suit Ford Ranger	PX III XLT 8/2018+ 3.2L Diesel	IISNORKEL034XLT	46
To Suit Ford Ranger	PX / PX II XL 7/2011+ 2.2 and 3.2L Diesel	ISNORKEL034	50, 54
To Suit Ford Ranger	PX / PX II XLT 7/2011+ 2.2 and 3.2L Diesel	IISNORKEL034XLT	50, 54
To Suit Ford Ranger	PJ / PK 2006-2011+ - 3.0L TDi Diesel	ISNORKEL021	58
To Suit Holden Trailblazer	LT LTZ 2017+	ISNORKEL036	70
To Suit Holden Colorado / Colorado 7	RG 2012-10/2016	ISNORKEL036	72, 74, 77
To Suit Holden Colorado	RC 2008-2012	ISNORKEL028	81
To Suit Holden Rodeo	RA7 LX and LT 2007-7/2008 - (Does not fit DX Model)	ISNORKEL022	83
To Suit Isuzu D-Max	8/2019+	ISNORKEL074	90
To Suit Isuzu D-Max	6/2012 to 7/2019	ISNORKEL041	93, 96
To Suit Isuzu D-Max	2009-2012 - (Does not fit 4x2 SX Model)	ISNORKEL022	100
To Suit Isuzu MU-X	2014+	ISNORKEL041	102
To Suit Mazda BT50	11/2006-2012 - 3.0L TDi Diesel	ISNORKEL024	129
To Suit Mitsubishi MQ Triton	MQ 2015-10/2018	ISNORKEL050	174
To Suit Mitsubishi Triton	ML / MN 2006-2015	ISNORKEL020	179, 182
To Suit Nissan Navara	NP300 2015-2020 - Suits Wide and Narrow Body 2.3L Twin and Single Turbo Diesel	ISNORKEL048	188
To Suit Nissan Navara	D40 2005+ (Does not suit 2010+ STX - Spain Build Single Cab)	ISNORKEL019	191
To Suit Nissan Pathfinder	R51 2005-2013	ISNORKEL019	198
To Suit Nissan Patrol	GU Series 4 2005+	ISNORKEL013	206
To Suit Nissan Patrol	GU Series 1, 2 and 3 1998-2004	ISNORKEL015	207
To Suit Nissan Patrol	GQ 1987-1997 - (All models except 2.8L Diesel)	ISNORKEL011	216
To Suit Suzuki Jimny	GJ 2018+	ISNORKEL070	242
To Suit Toyota Fortuner	2015+	ISNORKEL053	260
To Suit Toyota Hilux	8/2020+ - 2.8L Turbo Diesel / Narrow Body Model	ISNORKEL051 / ISNORKEL076N	266
To Suit Toyota Hilux	Revo 2015-7/2020 - 2.8L Turbo Diesel	ISNORKEL051	270
To Suit Toyota Hilux	Vigo 2005-2015 - 3.0L TDi, 4.0L Petrol V6	ISNORKEL001	274
To Suit Toyota Landcruiser	200 Series 11/2015+	ISNORKEL056	283
To Suit Toyota Landcruiser	200 Series 11/2007-10/2015	ISNORKEL010	286
To Suit Toyota Landcruiser / Lexus	105 and 100 Series / LX 470 1998-2007	ISNORKEL003	288, 291
To Suit Toyota Landcruiser / Lexus	80 Series / LX 450 1990-1998	ISNORKEL004	293
To Suit Toyota Landcruiser	79 / 78 / 76 Series 2007+	ISNORKEL023	296, 299, 303, 311
To Suit Toyota Landcruiser	75, 78, 79 Series 1984-2007	ISNORKEL009	296, 307, 314
To Suit Toyota Prado	150 Series 11/2017+ 2.8L	ISNORKEL064	328
To Suit Toyota Prado	150 Series 11/2009-10/2017 3L D4D TDi / 4L Petrol V6 and 2.8L D4D TDi	ISNORKEL035	331
To Suit Toyota Prado	120 Series 2003-2009 3L D4D TDi / 4L Petrol V6	ISNORKEL006	334
To Suit Toyota Prado	90 / 95 Series 1996-2002 3.4L Petrol V6	ISNORKEL005	336
To Suit Volkswagen Amarok	2011+	ISNORKEL037	346, 348

REFER TO VEHICLE LISTING PAGES FOR SPECIFIC MODEL COMPATIBILITY / SUITABILITY

Underbody Protection

UNDERBODY PROTECTION

Vehicle Make	Model and Specifics	Standard Part No.	Premium Part No.	Page
To Suit Fiat Fullback	2016+	IUP050K	UBP050	41
To Suit Ford Ranger	PX III 8/2018+		UBP055	46
To Suit Ford Ranger	PX II 2015-7/2018	IUP014K / IUP014F	UBP054 / UBPO55	50
To Suit Ford Ranger	PX 7/2011-2015	IUP014K / IUP014F	UBP054	54
To Suit Ford Ranger	PJ / PK 2006-2011	IUP008K		58
To Suit Ford Everest	UA II 7/2018+		UBP055	61
To Suit Ford Everest	9/2015-6/2018	IUP014K	UBP054	63
To Suit Holden Colorado / Trailblazer	RG 11/2016-2020 / Trailblazer LT / LTZ 2017+		UBP057	70, 74
To Suit Holden Colorado	RG 2012-10/2016 / Colorado 7 RG 2012-2016		UBP041	72, 77
To Suit Holden Colorado	RC 2008-2012	IUP009K		81
To Suit Holden Rodeo	RA and RA7 2002-2008	IUP009K		83, 85
To Suit Isuzu D-Max	8/2019+		UBP074 / UBPO74S	90
To Suit Isuzu D-Max / MU-X	6/2012 to 7/2019 / MU-X 2014+		UBP041	93, 96, 102
To Suit Isuzu D-Max	2007-06/2012	IUP009K		100
To Suit Landrover Discovery	Series 3, 4 and Range Rover Sport 2005 to 2013	IUP016K		130
To Suit Mazda BT50	6/2020+		UBP074 / UBPO74S	139
To Suit Mazda BT50	2012-5/2020	IUP014K / IUP014F	UBP054 / UBPO55	142
To Suit Mazda BT50	2006-2011	IUP008K		146
To Suit Mitsubishi Pajero Sport	7/2019+		UBP050	154
To Suit Mitsubishi Pajero	2000-2011	IUP013K		158, 159
To Suit Mitsubishi Triton	2015+	IUP050K	UBP050	170, 174
To Suit Mitsubishi Triton	ML 2006-2009	IUP010K / IUP010F		182
To Suit Nissan Navara	NP300 2015-2020 (Series 1 / Series 2, 3 & 4)		UBP048 / UBPO48S	188
To Suit Nissan Navara	D40 2005+ (Diesel only)	IUP007K / IUP007F		191
To Suit Nissan Navara	D22 2002+ (Diesel only)	IUP006K		194
To Suit Nissan Pathfinder	R51 2005+	IUP007E		198
To Suit Nissan Patrol	GU Series 1, 2, 3 and 4 1998+ (3.0L and 4.8L only)	IUP015K		206, 207
To Suit Renault Alaskan	2017+ (Series 1 / Series 2, 3 & 4)		UBP048 / UBPO48S	228
To Suit SsangYong Musso / Rexton	Q200, Q201 & Q205 / Y400 10/2018+		UBP201SY	231, 236
To Suit Suzuki Jimny	GJ 2018+		UBP070	242
To Suit Suzuki Grand Vitara	Diesel Manual 8/2005-2015	IUP011K		248
To Suit Toyota FJ Cruiser	2006+	IUP003K	UBP047	258
To Suit Toyota Fortuner / Hilux	2015+		UBP051	260, 266, 270
To Suit Toyota Hilux	Vigo 2005-2015	IUP001K	UBP033	274
To Suit Toyota Landcruiser	200 Series 2015+		UBP056	283
To Suit Toyota Landcruiser	200 Series 11/2007-10/2015	IUP004K / IUP004F		286
To Suit Toyota Landcruiser	79 Series S/C 2007-8/2016 / 79 Series D/C 11/2012+ / 78/76 Series 2007+		UBP019 / UBPO19SC	296, 299, 303, 311
To Suit Toyota Prado	150 Series 11/2009+	IUP003K / IUP003F	UBP047	328, 331
To Suit Toyota Prado	120 Series 2003-2009	IUP002K		334
To Suit Volkswagen Amarok	2011-10/2016	IUP012K		348

REFER TO VEHICLE LISTING PAGES FOR SPECIFIC MODEL COMPATIBILITY / SUITABILITY

Roof Racks, Mount Kits and Roof Rail Extrusions

ROOF RACKS

Part Number	Type	Description	Weight	Dimensions (mm)		
STEEL			KG	L	W	H
IRRCAGE14	Cage Style	Steel Roof Rack	37kg	1400	1250	150
IRRCAGE18	Cage Style	Steel Roof Rack	46kg	1800	1250	150
IRRCAGE22	Cage Style	Steel Roof Rack	52kg	2200	1250	150
IRRTENT18	Rooftop Tent Compatible	Steel Roof Rack	37kg	1800	1250	150
IRRTENT22	Rooftop Tent Compatible	Steel Roof Rack	45kg	2200	1250	150
IRRTRADE18	Trade Style	Steel Roof Rack - Open End	42kg	1800	1250	150
IRRTRADE22	Trade Style	Steel Roof Rack - Open End	49kg	2200	1250	150
ALLOY			KG	L	W	H
IRRCAGE14-ALLOY	Cage Style	Alloy Roof Rack - Mesh Floor	17kg	1400	1250	150
IRRCAGE18-ALLOY	Cage Style	Alloy Roof Rack - Mesh Floor	22kg	1800	1250	150
IRRCAGE22-ALLOY	Cage Style	Alloy Roof Rack - Mesh Floor	27kg	2200	1250	150
IRROPEN14-ALLOY	Trade Style	Alloy Roof Rack - Mesh Floor, Open End	16kg	1400	1250	150
IRRTRADE18-ALLOY	Trade Style	Alloy Roof Rack - Mesh Floor, Open End	20kg	1800	1250	150
IRRTRADE22-ALLOY	Trade Style	Alloy Roof Rack - Mesh Floor, Open End	25kg	2200	1250	150
IRRTFLAT18-ALLOY	Flat Style	Alloy Roof Rack - Mesh Floor	18kg	1800	1250	30

MOUNTING KITS

Part Number	Feet	Description	Height
IRRFEE100	8	100mm Gutter Mount	100
IRRFEE125	8	125mm Gutter Mount	125
IRRFEE150	8	150mm Gutter Mount	150
IRRFEE210	8	210mm Gutter Mount	210
IRRFEE1LC100	8	To Suit Landcruiser 100 / 105 Series Roof Mount	Adjustable
IRRFEE1LC200	8	To Suit Landcruiser 200 Series Roof Mount	Adjustable
IRRFEE1001	6	To Suit Holden Colorado 7	Fixed
IRRFEE1PRADO150	2	To Suit Toyota Prado 150	Fixed
IRRFEE1MUX	4	To Suit Isuzu MU-X - Replaces Roof Rails	Fixed
IRRFEE1ABS14	4 (2 pieces)	ABS Canopies 010 / 011 / 012 / 013 / 014 / 015 / 019 / 020	45

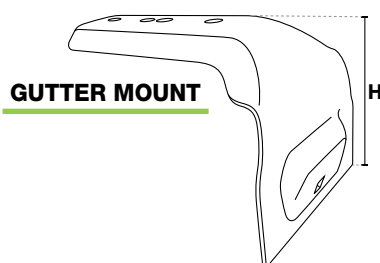
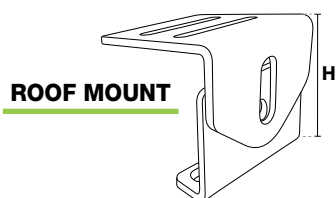

UNIVERSAL ALLOY ROOF RAIL EXTRUSION

Part Number	Pieces	Description	Length
IRREXT1085	2	Alloy Roof Rail Extrusion	1085

REFER TO VEHICLE LISTING PAGES FOR SPECIFIC MODEL COMPATIBILITY / SUITABILITY

Canopies

ABS PLASTIC CANOPIES - GENERIC LISTING (WEIGHT 80KG)

Vehicle Make	Model and Specifics	Part Number	Page
To Suit Fiat Fullback	2016+	CANOPY014*	41
To Suit Ford Ranger	PX 2011-2015* / PX II 2015-7/2018 / PX III 8/2018+ / Raptor 9/2018+	CANOPY010*	45, 47, 51, 55
To Suit Ford Ranger	PJ / PK 2006 to 2011	CANOPY004*	58
To Suit Holden Colorado	RG 2012 to 2020	CANOPY019*	74, 77
To Suit Holden Colorado / Rodeo	RC 7/2008 to 12/2012 / RA7 2007 to 7/2008 / RA 2002 to 2006	CANOPY006	81, 83, 85
To Suit Isuzu D-Max	8/2019+	CANOPY022*	90
To Suit Isuzu D-Max	6/2012 to 7/2019	CANOPY020*	93, 96
To Suit Isuzu D-Max	2007 to 6/2012	CANOPY006	100
To Suit LDV T60	2017+	CANOPY015*	134
To Suit Mazda BT50	6/2020	CANOPY022*	139
To Suit Mazda BT50	2012 to 5/2020	CANOPY010*	143
To Suit Mazda BT50	J97M 2006 to 2011	CANOPY004	146
To Suit Mitsubishi Triton	MQ 2015-10/2018 / MR 11/2018+	CANOPY014*	171, 175
To Suit Mitsubishi Triton	MN 2009 to 2015	CANOPY008*	179
To Suit Nissan Navara	NP300 2015 to 2020	CANOPY013*	188
To Suit Nissan Navara	D22 2002+	CANOPY007*	194
To Suit Renault Alaskan	2017+	CANOPY013*	228
To Suit Toyota Hilux	2015+	CANOPY015* / CANOPY017-SW	266, 270
To Suit Toyota Hilux	J Deck 3/2005 to 2015	CANOPY002*	274
To Suit Volkswagen Amarok	2011+	CANOPY021	346, 348

* Colour coded options available

PINNACLE FIBREGLASS CANOPIES - GENERIC LISTING (WEIGHT 100KG)

Vehicle Make	Model and Specifics	Part Number	Page
To Suit Fiat Fullback	2016+	CANFIBRE050*	41
To Suit Ford Ranger	PX 2011-2015* / PX II 2015-7/2018 / PX III 8/2018+ / Raptor 9/2018+	CANFIBRE054*	45, 47, 51, 55
To Suit LDV T60	2017+	CANFIBRE051*	134
To Suit Mazda BT50	2012 to 5/2020	CANFIBRE054*	143
To Suit Mitsubishi Triton	MQ 2015-10/2018 / MR 11/2018+	CANFIBRE050*	171, 175
To Suit Nissan Navara	NP300 2015 to 2020	CANFIBRE048*	188
To Suit Renault Alaskan	2017+	CANFIBRE048*	228
To Suit Toyota Hilux	2015+	CANFIBRE051*	227, 271

* Colour coded options available

TRADESTYLE FIBREGLASS CANOPY - (WEIGHT 90KG)

Vehicle Make	Model and Specifics	Part Number	Page
To Suit Toyota Hilux	To Suit Vigo 2005-2015 Color Coded Toyota White	CANFIBRE001	274

SUPERLOCK KIT MUST BE USED TO SECURE CANOPIES TO VEHICLES FITTED WITH IRONMAN 4X4 TUB LINER



LED Driving Lights and Upgrades

LED DRIVING LIGHTS

Operating Voltage: 12-24V DC

IMEGATOM

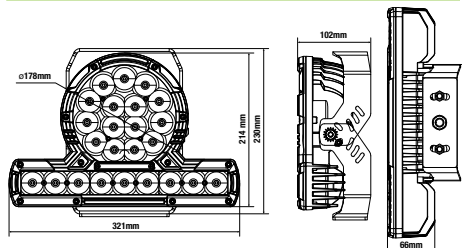

Operating Voltage: 9-30V DC

ILED5X7

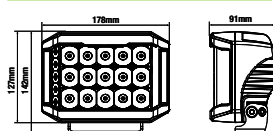

ILEDBLAST2C

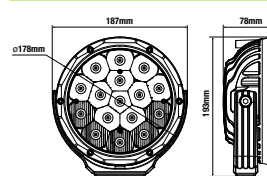

ILEDBLAST2S

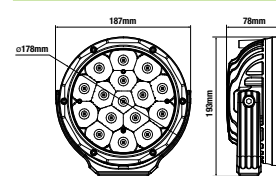

ILED7M

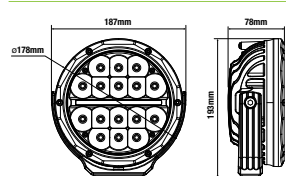

ILED9M

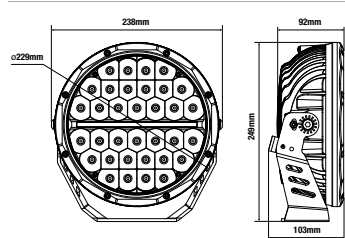

ILED7C

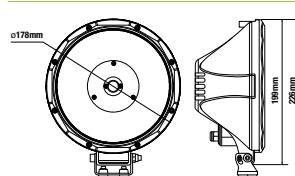

ILED9C

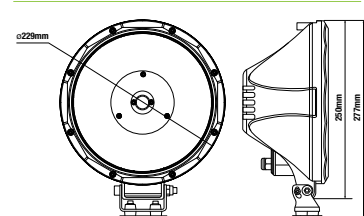

LED WORK AND UNIVERSAL LIGHTS

Operating Voltage: 12-24V DC

ILEDWL10 / ILEDWL10FA

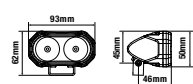

ILEDUNI3

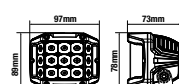

ILEDUNI5

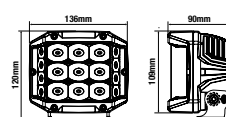

ILED20B SERIES

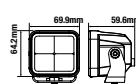

ILED80B SERIES

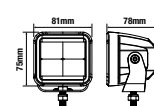

9430

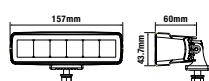

IRL120B

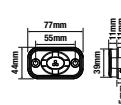

ILEDCOSMO

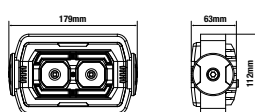

ILED5B

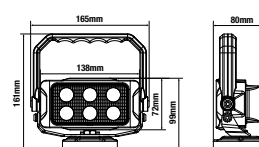

BULL BAR UPGRADE LED LIGHTS

BBPART031

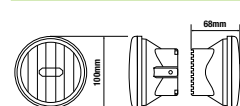

Operating Voltage: 9-32V DC

BBPART002

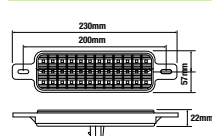

Operating Voltage: 12V DC

LED Work Lights and Light Bars

NEW SINGLE ROW - SLIM
Operating Voltage: 12-24V DC

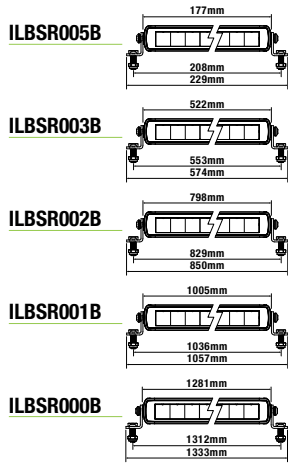

NEW SINGLE ROW - WIDE
Operating Voltage: 12-24V DC

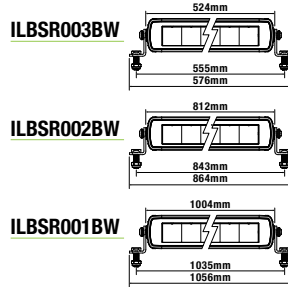

NEW DUAL ROW
Operating Voltage: 12-24V DC

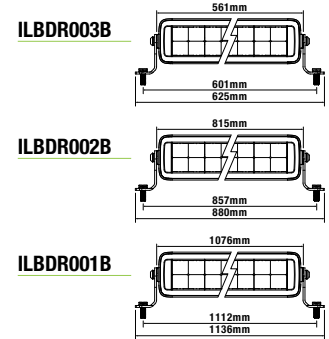

LED LIGHT BARS - STRAIGHT
Operating Voltage: 12-24V DC

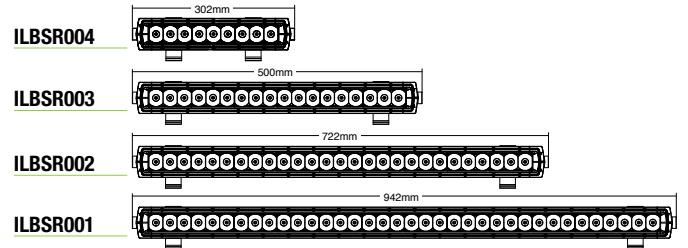
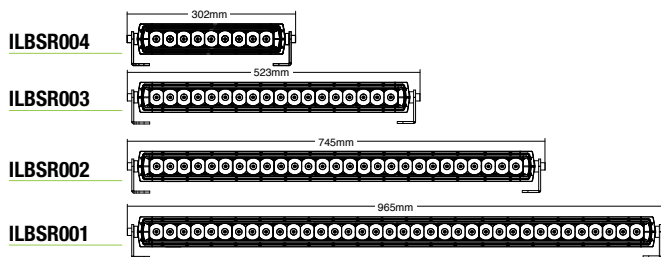

LED LIGHT BARS - CURVED
Operating Voltage: 12-24V DC

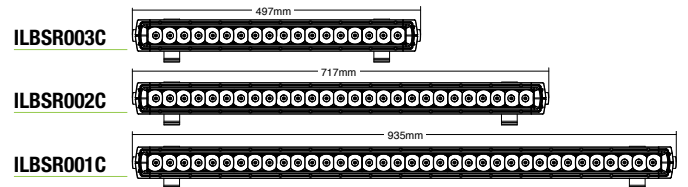
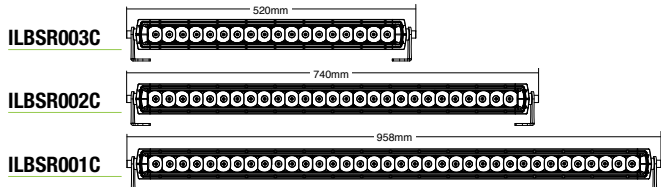

LED LIGHT BARS - MODULAR
Operating Voltage: 12-24V DC

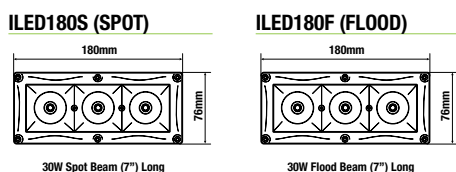

MODULAR COMBINATIONS

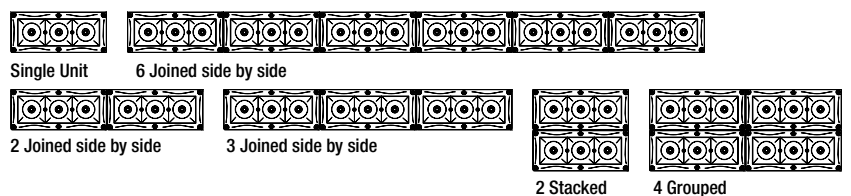

Fridges and Fridge Troubleshooting

FRIDGE ERROR CODES

Code	Error Type - Refer to User Manual for further information	Possible solution
E1	Battery protection stop auto cut-off (Battery too low or adjust protection setting)	Set battery protection to lower setting
E2	Fan fault (Check clearance around the fan)	Check for fan obstructions
E3	Compressor motor starter error (Low voltage power supply)	Check available voltage of 12/24V power supply, check all connections between battery and fridge, check condition of plug in lead
E4	Compressor motor running speed error (Overloaded motor cannot maintain 1850 times / min which is the lowest speed)	Return to place of purchase for assessment
E5	Compressor has over heated (Check clearance around the fan)	Check for sufficient air flow clearance around fridge
ER1	Control panel and temperature probe fault	Replacement of control panel or temperature probe

Unit will not turn on

- Check power supply ie. Battery voltage (See Battery Protection table on Page 5 of User Handbook)
- Check all connections between battery and fridge
- Check condition of fuse
- Check that the unit is turned on

Poor refrigeration performance

- Too much food has been placed inside refrigerator
- Temperature of food placed in fridge is too high
- The door is not closed properly
- Door seal is broken

Poor cooling

- Make sure adequate ventilation room is left around unit (See General Notes Page 4 of User Handbook)
- Ambient temperature is extremely high
- Temperature is not set correctly

Contents of fridge are freezing

- Temperature setting is too low

Noise

- Unit is not on a flat or level surface
- Check for vibrations in surrounding objects

Sound of water from inside of unit

- This is normal due to flow of refrigerant

FRIDGE FAQ's

- Q.** Where can I find a list of the fault codes? **A.** See User Handbook (or above)
- Q.** Why is my fridge freezing everything? **A.** Temperature is set to degrees Fahrenheit, reset to degrees Celsius
- Q.** My fridge will not turn on? **A.** Hold On/Off button until the display illuminates
- Q.** My fridge isn't staying on? **A.** Check the battery protection setting, and ensure it is set correctly by referring to your User Handbook

ICE CUBE FRIDGE / FREEZERS

30L ICECUBE FRIDGE / FREEZER - IFRIDGE30SP

Overall Dimensions	590(L) (650mm with handle) x 380(H) x 340mm(W)
Weight	18kg (35lb)
Temperature Range / Regulation	+10 °C to -18 °C
Average Power Consumption	40 Watt

40L ICECUBE FRIDGE / FREEZER - IFRIDGE40SP

Overall Dimensions	590(L) (650mm with handle) x 440(H) x 350mm(W)
Weight	20kg (37lb)
Temperature Range / Regulation	+10 °C to -18 °C
Average Power Consumption	40 Watt

50L ICECUBE FRIDGE / FREEZER - IFRIDGE50SP

Overall Dimensions	590(L) (650mm with handle) x 520(H) x 350mm(W)
Weight	22kg (41lb)
Temperature Range / Regulation	+10 °C to -18 °C
Average Power Consumption	40 Watt

65L ICECUBE FRIDGE / FREEZER - IFRIDGE65SP

Overall Dimensions	820(L) x 495(H) x 490mm(W)
Weight	33kg (66lb)
Temperature Range / Regulation	+10 °C to -18 °C
Average Power Consumption	55 Watt

74L ICECUBE FRIDGE / FREEZER - IFRIDGE74SP

Overall Dimensions	820(L) x 495(H) x 490mm(W)
Weight	32kg (66lb)
Temperature Range / Regulation	+10 °C to -18 °C
Average Power Consumption	55 Watt



Fridges, Slides and Drawer Systems

CONFIGURATIONS

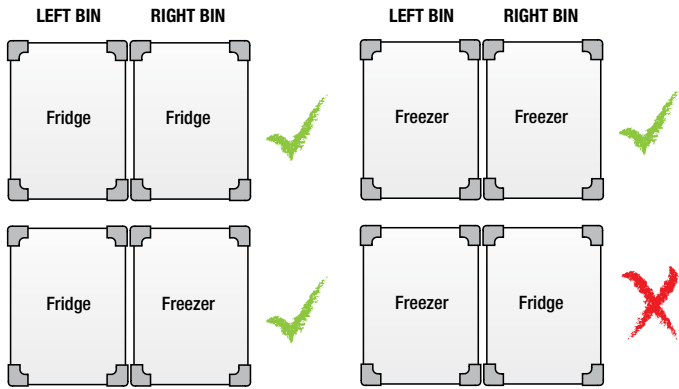

MEASUREMENTS

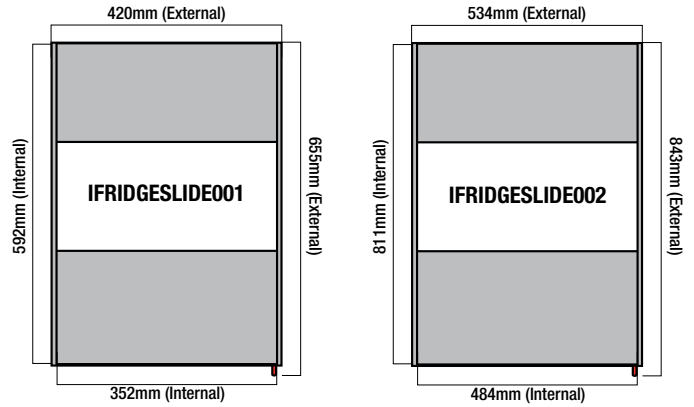

LOCKSAFE DRAWER SYSTEMS

900mm Drawer System	Weight	Length (mm)	Height (mm)	Width (mm)
TWIN - Cabinet specifications including drawers*	63kg	900	275	970
TWIN - Drawer specifications		840	206	425
SINGLE - Cabinet specifications including drawers*	34kg	900	275	490
SINGLE - Drawer specifications		840	206	425

1000mm Drawer System	Weight	Length (mm)	Height (mm)	Width (mm)
TWIN - Cabinet specifications including drawers*	76kg	1000	275	1020
TWIN - Drawer specifications		940	206	450
SINGLE - Cabinet specifications including drawers*	39kg	1000	275	510
SINGLE - Drawer specifications		940	206	425

1300mm Drawer System	Weight	Length (mm)	Height (mm)	Width (mm)
TWIN - Cabinet specifications including drawers*	89kg	1300	275	970
TWIN - Drawer specifications		1240	206	425
SINGLE - Cabinet specifications including drawers*	46kg	1300	275	490
SINGLE - Drawer specifications		1240	206	425

* Top of timber to underside of fixing ribs

TWIN DRAWERS

SINGLE DRAWERS

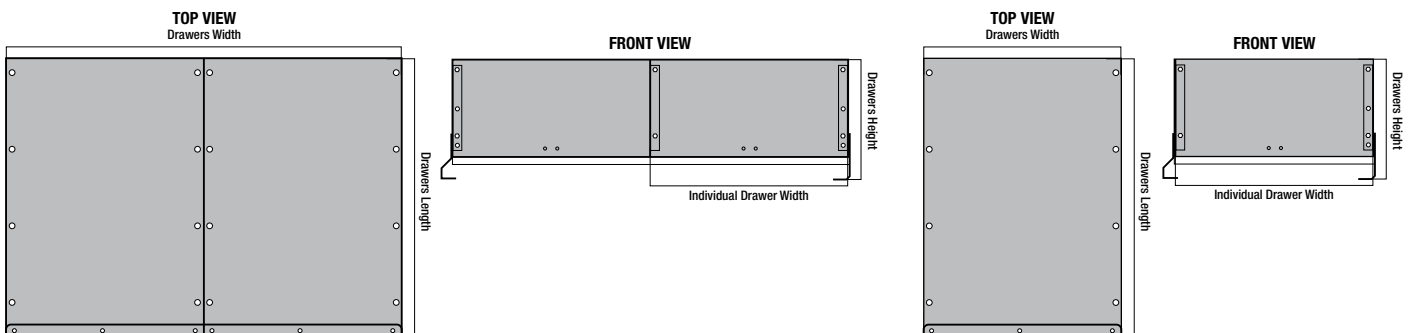

• All drawers extend 950mm from rear of unit. For an absolute overall width of each cabinet, add 26mm to the widths given above. Basic cabinet height is 238mm with 12mm carpeted ply on top and 20mm high fixing ribs under, giving an overall height of 270mm

REFER TO VEHICLE LISTING PAGES FOR SPECIFIC MODEL COMPATIBILITY / SUITABILITY

Roof Top Tent and Camping Swags

LUXURY ROOF TOP TENT - (WEIGHT 62KG)

OPEN

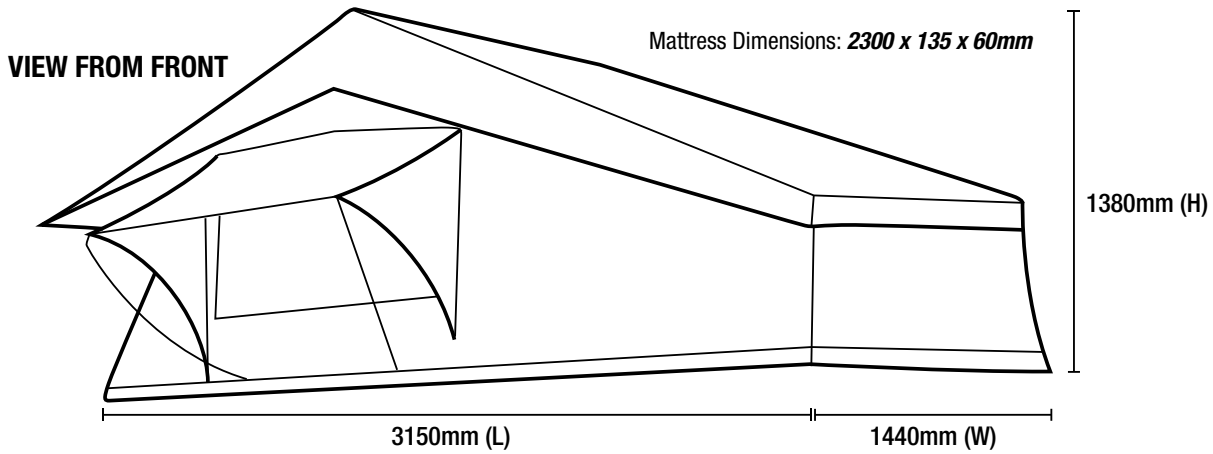

CLOSED

VIEW FROM PASSENGER SIDE

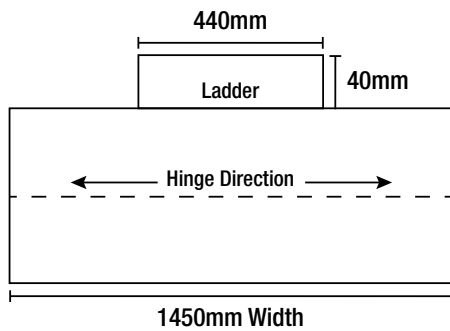

VIEW FROM FRONT

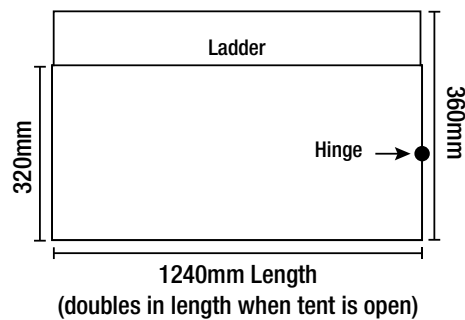

CAMPING SWAGS

SINGLE SWAG

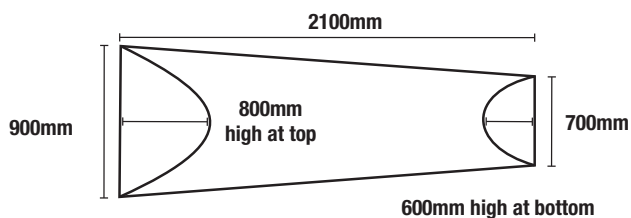

DOUBLE SWAG

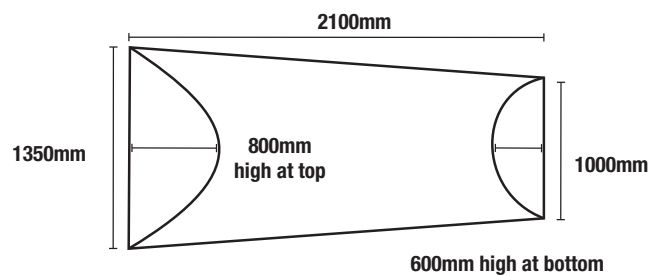

Quick Reference Index



Product Codes

Part Number	Page
343LH	325, 327
343RH	325, 327
344	325
345	325
346	325, 327
347	325
348LH	315, 319, 320, 322, 324, 326
348RH	315, 319, 320, 322, 324, 326
351	315, 319, 320, 321, 322, 324, 326
353LH	136, 215, 217, 315, 319, 321, 322, 324
353RH	136, 215, 217, 315, 319, 321, 322, 324
354	315, 319
355K	223
384	280, 281
385	256, 280, 281
386	256, 280, 281
386-1	59, 60, 147, 149, 279
386-2	80, 82, 84, 86, 99, 101, 256, 280, 281
386-3	121, 275, 277
387-1	43, 48, 52, 56, 75, 78, 82, 84, 86, 91, 94, 97, 101, 121, 134, 140, 144, 173, 177, 181, 183, 185, 186, 268, 272, 275, 277, 279
415UBK	60, 86, 149, 265, 277, 318, 319, 321, 322, 324, 325, 326, 327, 347, 349
416UBK	224, 298, 300, 304, 308, 312, 315
416UBKL	298, 300, 304, 308
417UBK	48, 52, 56, 59, 80, 82, 84, 99, 101, 144, 147
436UBK	217, 315, 319, 320, 322
437UBK	43, 173, 177, 192, 193, 256, 275, 279, 280, 281, 339
437UBKL	43, 75, 78, 91, 94, 97, 121, 134, 140, 173, 177, 192, 193, 268, 272, 275, 279
449UBK	324
45RSS001	407, 408
45RSS002	408
45RSS003	408
45RSS004	407
45RSS005	408
45SK6520	407, 408
45SK7218	408
45SK7220	407, 408
45TAR001	407, 408
45TAR002	407, 408
451UBK	67, 68, 87, 105, 106, 163, 165, 168, 185, 186, 187, 222, 223

Part Number	Page
452UBK	222, 223
453UBK	222, 223
470	222, 223
512UBK	109
632RF	404, 405, 406, 407, 408, 410
635R	407
635RK	404, 405, 406, 407
654UBK	197, 247
655UBK	247
656R	404, 406
656RK	404, 405, 406, 407, 408
664	222, 223
665	222
667	215, 217
669UBK	217
670UBK	217
678UBK	75, 78, 91, 94, 97, 140, 280, 281, 341, 344, 345
704TUK	190
704UK	195, 196
713UK	325, 327
714UK	325
715STUK	168
715TUK	163, 181, 183, 185, 186
715UK	165, 187
718UK	217
719UK	136, 215, 217, 315, 319, 320, 321, 322, 324, 326
720UK	315
721UK	223
722UK	222, 223
724UK	222
728TUK	82, 84, 101
728UK	80, 86, 87, 99
728UKL	265
732UK	280, 281
733UK	256, 280, 281
734UK	247
747UK	67, 68, 105, 106
756UK	60, 149
758UK	279
759UK	59, 147
762UK	109
767UK	121, 268, 272, 275, 277
769UK	192, 193, 224
769UKL	197
770UK	75, 78, 91, 94, 97, 134, 140
788UBK	195, 196
791	67, 68, 87, 105, 106
792	67, 68, 87, 105, 106
794	60, 149
795	163, 165, 168, 181, 183, 185, 186, 187
796	163, 165, 168, 187
797	195, 196
797-1	192, 193, 224
797-2	197

Part Number	Page
797-3	190
798	195, 196, 197
832RT	414
833R	414
833WT	208, 212, 215, 218, 220
834RT	414
836RT	414
839CRK	209, 213, 219, 221
839RK	209, 213, 219, 221
840RT	414
841RT	414
843RT	414
844RT	414
845RT	414
846RT	414
847CRK	290, 295
847RK	290, 295
848CRK	209
848RK	209
848RT	414
1002K	215, 218, 220
1084UK	304, 308
1085UK	298, 300, 312
1100UBK	215
1100UBKL	215
1102UBK	181, 183
1103UBK	136
1104UBK	190
1105UBK	234
1106UBK	264
1141	298, 300, 304, 308, 312, 318
1141-1	312, 318
1142	298, 300, 304, 308, 312, 318
1144	289, 294, 297, 300, 304, 308, 312, 318
1144R	414
1144RK	208, 212, 215, 218, 220, 289, 294, 297, 300, 304, 308, 312, 318
1144SK	208, 212, 215, 218, 220, 289, 294, 297, 300, 304, 308, 312, 318
1145SK	126, 127, 128, 129, 133
1146RK	243, 245, 246
1147	48, 52, 56, 144
1148	75, 78, 94, 97, 134
1149	136
1150	341
1151UK	277
1152K	91, 94, 97, 140
1153UK	234
1154UK	264
1155	268, 272
1156	91, 140
1185UK	318
1188UK	344, 345

Part Number	Page
1189	344, 345
1190UK	347, 349
1191UK	339
1192K	261, 263, 268, 272, 339
1193UK	48, 52, 56, 144
1194K	48, 52, 56, 144
1196UK	341
1197K	341
1198K	253, 259, 263, 275, 329, 332, 334
1199	43, 173, 177
1200UK	43, 173, 177
1201K	43, 173, 177
1202K	113
1203K	52, 56, 144
1204K	153, 189, 229
1205K	43, 173, 177
1207K	134
1208K	134
1209K	253, 259, 329, 332, 339
1210K	261, 268, 272
1211K	243
1213K	268, 272
1214K	48, 62
1215K	238, 240, 241
1216K	238, 241
1217K	341
1218ADK	253, 329, 332, 335
1218R	259, 329, 332, 335
1219R	243
1220K	253, 329, 332, 335
2244AK	404
2244AK	404, 405, 406
2244K	404, 405, 406, 407, 408, 410
3501	208
3502	132
3511	129, 133, 208, 212, 215
3517	162, 163, 164, 165, 185, 186, 187
3521	280, 281
3521S	245
3522	217, 222, 223
3523	324, 325, 326, 327
3524	289, 294, 297, 308, 315, 316, 317, 319, 320, 322
3525	297, 300, 308, 312, 318
3530	247
3532	126, 127, 128
3533	255, 256, 279
3534	218, 220
3536	218, 220
3540	109, 115, 119, 120
3541	119
3542	243
3543	111, 117
3544	111, 117
12075GR	222, 223



Product Codes

Part Number	Page
12076GR	222, 223
12080GR	126, 127, 128, 129, 133
12081GR	268, 272, 275, 279, 315, 318
12081GRC	268, 272, 275, 279, 315, 318
12082GR	164, 165, 186, 187
12083GR	250, 251
12085GR	247
12086GR	247
12087GR	67, 68, 87, 89, 105, 106, 136, 137, 162, 163, 167, 168, 185, 196
12088GR	255, 256, 279
12089GR	250, 251
12091GR	208, 212, 215, 218, 220, 297, 300, 304, 308, 312, 317, 318
12094GR	209, 213, 218, 220, 297, 300, 304, 308, 312
12094GRC	297, 300, 304, 308, 312
12095GR	48, 52, 56, 59, 60, 144, 147, 149
12095GRC	48, 52, 56, 59, 60, 144, 147, 149
12635GR	324, 325, 326, 327
12635GRC	324, 325, 326, 327
12636GR	68, 75, 78, 80, 82, 84, 86, 87, 94, 97, 99, 101, 106, 134, 163, 165, 168, 181, 183, 186, 187, 195, 196, 203, 281, 322, 324, 325, 326, 327
12636GRC	68, 75, 78, 80, 82, 84, 86, 87, 94, 97, 99, 101, 106, 134, 163, 165, 168, 181, 183, 186, 187, 195, 196, 203, 281, 322, 324, 325, 326, 327
12636GRP	75, 78, 80, 82, 84, 86, 87, 94, 97, 99, 101, 134, 163, 165, 168, 181, 183, 186, 187, 195, 196, 203, 281, 322, 324, 325, 326, 327
12637GR	89, 255, 315, 319, 320, 322
12637GRC	89, 255, 315, 319, 320, 322
12637GRS	345
12639GR	280, 281
12639GRC	280, 281
12639GRS	317
12640GR	126, 127, 128, 129, 133
12643GR	66, 86, 104
12644GR	66, 69, 104
12645GR	164, 167
12645GRC	164, 167
12645GRS	155, 157, 166
12646GR	162
12648GR	215, 217
12650GR	121, 256, 275, 277, 280, 317, 319, 321

Part Number	Page
12650GRC	121, 256, 275, 277, 280, 319, 321
12652GR	344
12658GR	250, 251
12661GR	217, 254, 337
12661GRS	235
12665GR	109, 115, 120
12666GR	109
12667GR	59, 60, 69, 82, 84, 101, 147, 149, 169, 203, 235, 265
12669GR	120
12670GR	115
12671GR	67, 105, 169
12682GR	259, 289, 294
12682GRC	253, 259, 329, 332, 335
12682GRP	253, 259, 329, 332, 335
12683GR	289, 294
12691GR	254, 337
12696GR	316
12697GR	316
12698GR	91, 140, 169, 185, 190, 197, 344, 345
12698GRC	91, 140, 185, 190, 197
12698GRP	91, 140, 185
12710GR	65, 121, 253, 259, 263, 275, 329, 334, 339
12711GR	107, 108
12712GR	107, 108
12713GR	160
12714GR	160
12715GR	42, 155, 157, 166, 172, 176, 180, 183
12716GR	153, 189, 190, 192, 193, 199, 201, 224, 229
12717GR	192, 193, 224
12718GR	199, 201
12720GR	284, 287
12721GR	249
12722GR	249
12725GR	347, 349
12726GR	347, 349
12727GR	52, 56, 64, 144
12728GR	153, 189, 229
12729GR	43, 173, 177
12729GRC	43, 173, 177
12729GRP	43, 173, 177
12730GR	261, 268, 272
12731GR	136
12732GR	62, 64
12735GR	113
12738GR LH/RH	113
12740GR	205
12742GR	205
12743GR	261, 263
12743GRC	261, 263
12744GR	339

Part Number	Page
12745GR	71, 73, 75, 78, 94, 97, 103, 134
12746GR	71, 73, 103
12746GRC	71, 73, 103
12747GR	40, 230
12748GR	40, 230
12749GR	136, 137
12750GR	332
12751GR	119
12751LGR	119
12752GR	119
12752LGR	119
12755GR	342
12759GR	243, 245
12760GR	243, 245
12764GR LH	277
12764GR RH	277
12765GR	343
12774GR	114
12775GR	114
12776GR	132
12777GR	132
12791GR	195, 197
12795GR	292
12796GR	284, 287, 292
12797GR	80, 99
12804GR	65
12805GR	265
12805GRC	265
12811GR	150
12812GR	150
12823GR	232, 233, 234, 237
12824GR	232
12825GR	233
12826GR	234
12827GR	48, 62
12828GR	237
12845GR	91, 140
12851GR	111, 117
12851GRC	111, 117
12852GR	117
12852GRC	117
24080FE	126, 127, 128, 129, 133
24081FE	268, 272, 275, 279, 315, 318
24081FEC	268, 272, 275, 279, 315, 318
24081FEP	268, 272, 275, 279, 315, 318
24082FE	164, 165, 186, 187
24087FE	67, 68, 87, 89, 105, 106, 162, 163, 167, 168, 185, 196
24088FE	255, 256, 279
24091FE	208, 212, 215, 218, 220, 297, 300, 304, 308, 312, 317, 318
24091FEP	208, 212, 218, 220

Part Number	Page
24091LFE	208, 212, 218, 220
24091LFE1	208, 212, 218, 220
24094FE	209, 213, 218, 220, 297, 300, 304, 308, 312
24094FEC	297, 300, 304, 308, 312
24094FEP	209, 213, 218, 220, 297, 300, 304, 308, 312
24094LFE	209, 213, 218, 220, 297, 300, 304, 308, 312
24094LFE1	209, 213, 218, 220
24094LFEC	297, 300, 304, 308, 312
24094LFEP	209, 213, 218, 220, 297, 300, 304, 308, 312
24095FE	48, 52, 56, 59, 60, 144, 147, 149
24095FEC	48, 52, 56, 59, 60, 144, 147, 149
24095FEP	48, 52, 56, 60, 144, 147, 149
24635FE	324, 325, 326, 327
24635FEC	324, 325, 326, 327
24636FE	68, 75, 78, 80, 82, 84, 86, 87, 94, 97, 99, 101, 106, 134, 163, 165, 168, 181, 183, 186, 187, 196, 203, 281, 322, 324, 325, 326, 327
24636FEC	68, 75, 78, 80, 82, 84, 86, 87, 94, 97, 99, 101, 106, 134, 163, 165, 168, 181, 183, 186, 187, 196, 203, 281, 322, 324, 325, 326, 327
24636FEP	75, 78, 80, 82, 84, 86, 87, 94, 97, 99, 101, 134, 163, 165, 168, 181, 183, 186, 187, 196, 203, 281, 322, 324, 325, 326, 327
24637FE	255, 315, 319, 320, 322
24637FEC	255, 315, 319, 320, 322
24637FES	345
24639FE	280, 281
24639FES	317
24640FE	126, 127, 128, 129, 133
24643FE	66, 104
24644FE	66, 69, 104
24645FE	164, 167
24645FEC	164, 167
24645FES	155, 157, 166
24646FE	162
24648FE	215, 217
24650FE	121, 256, 275, 277, 280, 317, 319, 321
24650FEC	121, 256, 275, 277, 280, 319, 321
24650FEP	121, 256, 277, 280, 319, 321
24652FE	344
24661FE	217, 254, 337
24661FES	235
24665FE	109, 115, 120

Product Codes

Part Number	Page
24666FE	109
24667FE	59, 60, 69, 82, 84, 101, 147, 149, 169, 203, 235, 265
24682FE	259, 289, 294
24682FEC	253, 259, 329, 332, 335
24682FEP	253, 259, 329, 332, 335
24682LFE	289, 294
24682LFE1	289, 294
24683FE	289, 294
24683LFE	289, 294
24683LFE1	289, 294
24691FE	254, 337
24696FE	316
24697FE	316
24698FE	91, 140, 185, 190, 197, 344, 345
24698FEC	91, 140, 185, 190, 197
24698FEP	91, 140, 185, 190, 197
24710FE	65, 121, 253, 259, 263, 275, 329, 334, 339
24713FE	160
24715FE	42, 155, 157, 166, 172, 176, 180, 183
24716FE	153, 189, 190, 192, 193, 199, 201, 224, 229
24717FE	192, 193, 224
24717FEP	192, 193, 224
24718FE	199, 201
24720FE	284, 287
24727FE	52, 56, 64, 144
24728FE	153, 189, 229
24728FEP	153, 189, 229
24729FE	43, 173, 177
24729FEC	43, 173, 177
24729FEP	43, 173, 177
24730FE	261, 268, 272
24732FE	62, 64
24740FE	205
24742FE	205
24743FE	261, 263
24743FEC	261, 263
24744FE	339
24745FE	71, 73, 75, 78, 94, 97, 103, 134
24746FE	71, 73, 103
24746FEC	71, 73, 103
24750FE	332
24776FE	132
24777FE	132
24780FE	341
24781FE	341
24788FE	151
24789FE	151
24795FE	292
24796FE	284, 287, 292
24804FE	65
24805FE	265

Part Number	Page
24811FE	150
24812FE	150
24827FE	48, 62
24840FE LH	264
24840FE RH	264
24842FE	264
24842FEC	264
24845FE	91, 140
45080FE	126, 127, 128, 129, 133
45081FE	268, 272, 275, 315, 318
45081FEC	268, 272, 275, 315, 318
45081FEP	268, 272, 275, 315, 318
45091FE	208, 212, 215, 218, 220, 297, 300, 304, 308, 312, 318
45091FEP	208, 212, 215, 218, 220, 297, 300, 304, 308, 312, 318
45091LFE	208, 212, 218, 220
45091LFE1	208, 212, 218, 220
45091LFEP	208, 212, 218, 220
45094FE	209, 213, 218, 220, 297, 300, 304, 308, 312
45094FEC	297, 300, 304, 308, 312
45094FEP	209, 213, 218, 220, 297, 300, 304, 308, 312
45094LFE	209, 213, 218, 220, 297, 300, 304, 308, 312
45094LFE1	209, 213, 218, 220
45094LFEC	297, 300, 304, 308, 312
45094LFEP	209, 213, 218, 220, 297, 300, 304, 308, 312
45095FE	48, 52, 56, 59, 60, 144, 147, 149
45095FEC	48, 52, 56, 59, 60, 144, 147, 149
45095FEP	48, 52, 56, 60, 144, 147, 149
45635FE	324, 325, 326, 327
45636FE	75, 78, 94, 97, 134, 181, 183, 322, 324, 325, 326, 327
45636FEC	75, 78, 94, 97, 134, 181, 183, 322, 324, 325, 326, 327
45636FEP	75, 78, 94, 97, 134, 181, 183, 322, 324, 325, 326, 327
45637FE	315, 319, 320, 322
45637FEC	315, 319, 320, 322
45640FE	126, 127, 128, 129, 133
45648FE	215, 217
45650FE	121, 275, 319, 321
45650FEC	121, 275, 319, 321
45650FEP	121, 319, 321
45661FE	217, 254, 337
45667FE	59, 60, 147, 149
45682FE	259, 289, 294

Part Number	Page
45682FEC	253, 259, 329, 332, 335
45682FEP	253, 259, 329, 332, 335
45682LFE	289, 294
45682LFE1	289, 294
45683FE	289, 294
45683LFE	289, 294
45683LFE1	289, 294
45691FE	254, 337
45698FE	91, 140, 190
45698FEC	91, 140, 190
45698FEP	91, 140, 190
45710FE	121, 253, 259, 263, 275, 329, 334, 339
45715FE	42, 155, 157, 172, 176, 180, 183
45716FE	153, 189, 190, 192, 193, 199, 201, 224, 229
45716LFE	189, 190, 192, 193, 199, 201, 224, 229
45717FE	192, 193, 224
45717FEP	192, 193, 224
45720FE	284, 287
45727FE	52, 56, 64, 144
45728FE	153, 189, 229
45728FEC	153, 189, 229
45728FEP	153, 189, 229
45729FE	43, 173, 177
45729FEC	43, 173, 177
45729FEP	43, 173, 177
45730FE	261, 268, 272
45732FE	62, 64
45740FE	205
45742FE	205
45743FE	261, 263
45743FEC	261, 263
45744FE	339
45745FE	71, 73, 75, 78, 94, 97, 103, 134
45746FE	71, 73, 103
45746FEC	71, 73, 103
45750FE	332
45751FE	119
45751LFE	119
45752FE	119
45752LFE	119
45780FE	341
45781FE	341
45795FE	292
45796FE	284, 287, 292
45796FEP	284, 287, 292
45802FE	152
45803FE	152
45827FE	48, 62
45845FE	91, 140
45851FE	111, 117
45851FEC	111, 117
45852FE	117
45852FEC	117

Part Number	Page
45854FE	111
45854FEC	111
45855FE	227
45855LFE	227
45856FE	227
45856FEC	227
45856LFE	227
45856LFEC	227
12830007GR LH	238
12830007GR RH	238
12831009GR LH	240
12831009GR RH	240
12832008GR	238
12833009GR LH	240
12833009GR RH	240
12834010GR	240
12834014GR	240
12835011GR LH	241
12835011GR RH	241
12836012GR	241
ADL001	289, 294
ADL001L	289, 294
ADL003	212, 215, 218, 220
ADL005	208
ADL070	297, 300, 304
ADL106	280, 281
ATR001	289, 294
ATR003	212, 215, 218, 220
ATR005	208
ATR070	297, 300, 304
B9MK	410
BB030-SL	262
BB030-TL	262
BB038-SL	54
BB038-TL	54
BB039-SL	142
BB039-TL	142
BB048-SL	188, 228
BB048-TL	188, 228
BB050-SL	41, 174
BB050-TL	41, 174
BB051-SL	270
BB051-TL	270
BB053-SL	260
BB053-TL	260
BB054-SL	50, 63
BB054-TL	50, 63
BB056-SL	283
BB056-TL	283
BB057-SL	70, 74
BB057-TL	70, 74
BB058-SL	93
BB058-TL	93
BB059-EXCEED KIT	156
BB059-SL	156
BB059-TL	156
BB060-SL	346
BB060-TL	346

Product Codes

Part Number	Page
BB061-SL	102
BB061-TL	102
BB064-SL	328
BB064-TL	328
BB065-SL	270
BB065-TL	270
BB066-SL	46, 61
BB066-TL	46, 61
BB067-SL	170
BB067-TL	170
BB074-SL	90
BB074-TL	90
BB076-SL	266
BB076-TL	266
BB079-SL	154
BB079-TL	154
BB080-SL	139
BB080-TL	139
BB081-SL	260
BB081-TL	260
BBA038	54
BBA047	331
BBA048	188, 228
BBA050	41, 174
BBA051	270
BBA056-VX	283
BBA065	270
BBC002	274
BBC016	182
BBC018	296, 307, 314
BBC019E	296, 299, 303, 311
BBC019SC	296
BBC020	83, 100
BBC023	125
BBC024	146
BBC029	331
BBC030	262
BBC031	179
BBC033	274
BBC034	348
BBC038	54
BBC039	142
BBC040	77
BBC041	96
BBC043	286
BBC045	158, 159
BBC047	331
BBC048	188, 228
BBC050	41, 174
BBC051	270
BBC055	46, 50, 61, 63
BBC056	283
BBC057	70, 74
BBC058	93
BBC060	346
BBC065	270
BBC065-NB	270
BBCD001	278

Part Number	Page
BBCD002	274
BBCD003	85
BBCD004	293
BBCD005	288
BBCD006	291
BBCD007	336
BBCD008	334
BBCD009	207
BBCD010	216
BBCD012	191, 198
BBCD013	194
BBCD014	58
BBCD016	182
BBCD018	296, 307, 314
BBCD020	83, 100
BBCD024	146
BBCD027	81
BBCD029	331
BBCD030	262
BBCD031	179
BBCD033	274
BBCD034	348
BBCD035	118
BBCD037	258
BBCD038	54
BBCD039	142
BBCD040	77
BBCD041	96
BBCD042	191, 198
BBCD044	72
BBCD045	158, 159
BBCD046	248
BBCD047	331
BBCD048	188, 228
BBCD049	102
BBCD050	41
BBCD051	174, 270
BBCD052	112
BBCD053	260
BBCD054	50, 63
BBCD055	46, 50, 61, 63
BBCD057	70, 74
BBCD058	93
BBCD059	156
BBCD060	346
BBCD061	102
BBCD063	244
BBCD065	270
BBCD066	46, 61
BBCD067	170
BBCD068	134
BBCD070	242
BBCD071	231, 236
BBCD074	90
BBCD076	266
BBCD076-NB	266
BBCD079	154
BBCD080	139

Part Number	Page
BBCD081	260
BBF011	206
BBF019E	296, 299, 303, 311
BBF019SC	296
BBF025	286
BBF043	286
BBF056-VX	283
BBF062	204
BBF064	328
BBPART002	23, 352
BBPART006	352
BBPART008	352
BBPART009	352
BBPART009 L/H	352
BBPART009 R/H	352
BBPART010	352
BBPART011	352
BBPART012	352
BBPART013	352
BBPART014	352
BBPART015	352
BBPART017	352
BBPART018	356
BBPART019	352
BBPART020	352
BBPART021	352
BBPART022	352
BBPART022-LH	352
BBPART022-RH	352
BBPART023	352
BBPART024	352
BBPART025	352
BBPART026	352
BBPART031	23, 352
BBPARTLOOP001	352
BBPARTLOOP002	352
BBPARTLOOP003	352
BBPARTLOOP004	352
BBPARTLOOP005	352
BBPARTLOOP007	352
BBPARTLOOP008	352
BBPARTLOOP009	352
BBPARTLOOP010	352
BBPARTLOOP011	352
BBPARTLOOP012	352
BBPARTLOOP013	352
BBPARTLOOP014	352
BBPARTLOOP016	352
BBPARTLOOP019	352
BBPARTLOOP020	352
BBPARTLOOP024	352
BBPARTLOOP025	352
BBPARTLOOP027	352
BBPARTLOOP029	352
BBPARTLOOP031	352
BBPARTLOOP033	352
BBPARTLOOP034	352
BBPARTLOOP037	352

Part Number	Page
BBPARTLOOP038	352
BBPARTLOOP039	352
BBPARTLOOP040	352
BBPARTLOOP041	352
BBPARTLOOP042	352
BBPARTLOOP043	352
BBPARTLOOP044	352
BBPARTLOOP045	352
BBPARTLOOP047	353
BBPARTLOOP048	353
BBPARTLOOP049	353
BBPARTLOOP050	353
BBPARTLOOP051	353
BBPARTLOOP054	353
BBPARTLOOP056	353
BBPARTLOOP057	353
BBPARTLOOP058	353
BBR072	338
BBR073	340
BBR077	110, 116, 118
BBR077ST	110, 116, 118
BBR078	252
BBS070	242
BBT002	274
BBT008	334
BBT011	206
BBT012	191, 198
BBT013	194
BBT014	58
BBT016	182
BBT019E	296, 299, 303, 311
BBT019SC	296
BBT020	83, 100
BBT024	146
BBT027	81
BBT029	331
BBT030	262
BBT030-NL	262
BBT031	179
BBT033	274
BBT034	348
BBT038-NL	54
BBT039-NL	142
BBT041	96
BBT042	191, 198
BBT043	286
BBT044	72
BBT046	248
BBT048-NL	188, 228
BBT049	102
BBT050-NL	41, 174
BBT051-NL	270
BBT053	260
BBT053-NL	260
BBT054-NL	50, 63
BBT056VX-NL	283
BBT057-NL	70, 74
BBT058	93



Product Codes

Part Number	Page
BBT058-NL	93
BBT059-NL	156
BBT060-NL	346
BBT061-NL	102
BBT064-NL	328
BBT065-NL	270
BBT066-NL	46, 61
BBT067-NL	170
BBT074-NL	90
BBT076-NL	266
BBT079-NL	154
BBT080-NL	139
BBT081-NL	260
BHOSE001	289, 294
BHOSE002	289, 290, 294
BHOSE003	208, 212, 215, 218, 220
BHOSE004	209, 213, 219, 221
BHOSE005	208, 212
BHOSE009	243
CAN001	37
BRACKET100	292
CANFIBRE001	274
CANFIBRE048-BS	188, 228
CANFIBRE048-CB	188, 228
CANFIBRE048-HG	188, 228
CANFIBRE048-P	188, 228
CANFIBRE048-PW	188, 228
CANFIBRE048-SG	188, 228
CANFIBRE048-WINDOW	356
CANFIBRE048-WP	188, 228
CANFIBRE050-BM	41, 171, 175
CANFIBRE050-GG	171
CANFIBRE050-IB	41, 171, 175
CANFIBRE050-P	41, 171, 175
CANFIBRE050-SS	41, 171, 175
CANFIBRE050-TG	41, 175
CANFIBRE050-WINDOW	356
CANFIBRE050-WS	41, 171, 175
CANFIBRE051-AB	267, 271
CANFIBRE051-DG	267, 271
CANFIBRE051-P	134, 267, 271
CANFIBRE051-SM	267, 271
CANFIBRE051-SW	267, 271
CANFIBRE051-WINDOW	356
CANFIBRE054-AW	45, 47, 51, 55
CANFIBRE054-BL	45, 47, 51, 55
CANFIBRE054-FW	45, 47, 51, 55, 143
CANFIBRE054-IS	45, 47, 51, 55, 143
CANFIBRE054-M	45, 47, 51, 55, 143
CANFIBRE054-P	45, 47, 51, 55, 143
CANFIBRE054-SB	45, 47, 51, 55, 143
CANFIBRE054-WB	45, 47, 51, 55, 143
CANFIBRE054-WINDOW	356

Part Number	Page
CANFIBRE057-WINDOW	356
CANFIBRESPARE001	355
CANFIBRESPARE002	355
CANFIBRESPARE006	355
CANFIBRESPARE007	355
CANFIBRESPARE010	355
CANFIBRESPARE011	355
CANFIBRESPARE012	355
CANFIBRESPARE013	355
CANFIBRESPARE014	355
CANFIBRESPARE015	355
CANFIBRESPARE016	355
CANFIBRESPARE019	356
CANFIBRESPARE020	356
CANFIBRESPARE021	356
CANFIBRESPARE022	356
CANFIBRESPARE023	356
CANFIBRESPARE024	356
CANFIBRESPARE025	356
CANFIBRESPARE026	356
CANFIBRESPARE027	356
CANFIBRESPARE028	356
CANFIBRESPARE029	356
CANFIBRESPARE030	356
CANFIBRESPARE031	356
CANFIBRESPARE032	356
CANFIBRESPARE033	356
CANFIBRESPARE034	356
CANFIBRESPARE035	356
CANFIBRESPARE036	356
CANFIBRESPARE037	356
CANFIBRESPARE038	356
CANFIBRESPARE039	356
CANOPY002A	274
CANOPY002-P	274
CANOPY003-WINDOW	355
CANOPY004-P	58, 146
CANOPY004-W	58, 146
CANOPY004-WINDOW	355
CANOPY005-WINDOW	355
CANOPY006-P	81, 83, 85, 100
CANOPY006-WINDOW	355
CANOPY007-P	194
CANOPY007-WINDOW	355
CANOPY008-BM	179
CANOPY008-P	179
CANOPY008-WINDOW	355
CANOPY009-WINDOW	355
CANOPY010-AB	45, 47, 51, 55, 143
CANOPY010-AM	45, 47, 55, 143
CANOPY010-AW	45, 47, 51, 55, 143
CANOPY010-BL	45, 47, 51, 55, 143
CANOPY010-BRACKET	45, 47, 51, 55, 143
CANOPY010-CL-WINDOW	355
CANOPY010-CW	45, 47, 51, 55, 143

Part Number	Page
CANOPY010-FW	45, 47, 51, 55, 143
CANOPY010-G	45, 47, 51, 55, 143
CANOPY010-IS	45, 47, 51, 55, 143
CANOPY010-M	45, 47, 51, 55, 143
CANOPY010-MG	45, 47, 51, 55, 143
CANOPY010-P	45, 47, 51, 55, 143
CANOPY010-S	45, 47, 51, 55, 143
CANOPY010-SB	45, 47, 51, 55, 143
CANOPY010-TR	45, 47, 51, 55, 143
CANOPY010-WB	45, 47, 51, 55, 143
CANOPY010-WINDOW	355
CANOPY011-WINDOW	355
CANOPY012-WINDOW	355
CANOPY013-BS	188, 228
CANOPY013-CB	188, 228
CANOPY013-PW	188, 228
CANOPY013-SG	188, 228
CANOPY013-WP	188, 228
CANOPY014-BM	41, 171, 175
CANOPY014-CL-WINDOW	355
CANOPY014-EG	41, 171, 175
CANOPY014-GG	171
CANOPY014-IB	41, 171, 175
CANOPY014-P	41, 171, 175
CANOPY014-RS	41, 171, 175
CANOPY014-SS	41, 171, 175
CANOPY014-TG	41, 175
CANOPY014-WINDOW	355
CANOPY014-WS	41, 171, 175
CANOPY015-AB	266, 271
CANOPY015-BM	266, 271
CANOPY015-CL-WINDOW	355
CANOPY015-DG	266, 271
CANOPY015-P	134, 266, 271
CANOPY015-SW	266, 271
CANOPY015-WINDOW	355
CANOPY017-SW	271
CANOPY017-WINDOW	355
CANOPY018-B	143
CANOPY018-TF	143
CANOPY019-CL-WINDOW	355
CANOPY019-B	77
CANOPY019-BS	77
CANOPY019-G	74
CANOPY019-MB	74
CANOPY019-NS	74
CANOPY019-P	74, 77
CANOPY019-PB	74
CANOPY019-R	74
CANOPY019-S	77
CANOPY019-SW	74
CANOPY019-SW	77
CANOPY020-B	93
CANOPY020-CB	93

Part Number	Page
CANOPY020-CL-WINDOW	355
CANOPY020-GG	93
CANOPY020-P	93, 96
CANOPY020-SW	93, 96
CANOPY021-P	346, 348
CANOPY021-W	346, 348
CANOPY022-P	90, 139
CANOPY022-W	90, 139
CANOPY MOUNT KIT 014	354
CANOPY MOUNT KIT 015	354
CANOPYSPARE001	354
CANOPYSPARE002	354
CANOPYSPARE003	354
CANOPYSPARE004	354
CANOPYSPARE005	354
CANOPYSPARE006	354
CANOPYSPARE007	354
CANOPYSPARE008	354
CANOPYSPARE009	354
CANOPYSPARE010	354
CANOPYSPARE012	354
CANOPYSPARE013	354
CANOPYSPARE014	354
CANOPYSPARE015	354
CANOPYSPARE016	354
CANOPYSPARE017	354
CANOPYSPARE018	354
CANOPYSPARE019	354
CANOPYSPARE020	354
CANOPYSPARE021	354
CANOPYSPARE022	354
CANOPYSPARE023	354
CANOPYSPARE024	354
CANOPYSPARE025	354
CANOPYSPARE026	354
CANOPYSPARE027	354
CANOPYSPARE028	354
CANOPYSPARE029	354
CANOPYSPARE031	354
CANOPYSPARE032	354
CANOPYSPARE033	354
CANOPYSPARE034	354
CANOPYSPARE035	354
CANOPYSPARE036	354
CANOPYSPARE037	354
CANOPYSPARE038	354
CANOPYSPARE039	354
CANOPYSPARE040	354
CANOPYSPARE041	354
CANOPYSPARE042	354
CANOPYSPARE043	354
CANOPYSPARE044	354
CANOPYSPARE045	354
CANOPYSPARE046	354
CANOPYSPARE047	354

Product Codes

Part Number	Page
CANOPYSPARE048	355
CANOPYSPARE049	355
CANOPYSPARE050	355
CANOPYSPARE051	355
CANOPYSPARE052	355
CANOPYSPARE053	355
CANOPYSPARE054	355
CANOPYSPARE055	355
CANOPYSPARE056	355
CANOPYSPARE057	355
CANOPYSPARE058	355
CANOPYSPARE059	355
CANOPYSPARE060	355
CANOPYSPARE061	355
CANOPYSPARE062	355
CANOPYSPARE063	355
CANOPYSPARE064	355
CANOPYSPARE066	355
CANOPYSPARE068	355
CANOPYSPARE069	355
CANOPYSPARE070	355
CANOPYSPARE071	355
CANOPYSPARE072	355
CANOPYSPARE073	355
CANOPYSPARE074	355
CANOPYSPARE075	355
CANOPYSPARE076	355
CANOPYSPARE077	355
CANOPYSPARE078	355
CAP001	37
CB7	404, 405, 406
CB20	404, 406
CB35	405, 408
CPLATE001	289, 294
CPLATE003	208, 212, 215, 218, 220
DB140	27
DB270	27
DBLOOM	27
DB MONITOR	27
DBOX001	289, 294
DBOX003	208, 212, 215, 218, 220
DHOSE350	89
DVD001	37
DVD002	37
DVD003	37
DVD004	37
DVD005	37
DVD006	37
DVD007	37
DVD008	37
DVD009	37
ET17	404, 405, 406, 407, 408, 410
ET34	404, 405, 406, 408
ET38	404, 405, 406, 407, 408
ET38-1	408
ET38-2	405, 406, 408
ET69	404, 405, 406, 407

Part Number	Page
ET104	404, 406, 407
ET113	404, 406
ET113-1	404, 405, 406, 408
ET153	404, 406, 407
ET153-1	404, 405, 406, 407, 408
ET153-2	404, 406, 407, 408
ET153-3	405, 406, 408
ET154	405, 406, 408
ET155	405, 406, 408
ET158	404, 406
ET158-1	404, 406, 407
ET158-2	405, 406, 408
ET160	405, 406, 408
ET174	405, 406
ET175	405
ET176	405
ET177	405
FOR001A	52, 56, 64, 144
FOR001AKF	53, 57, 145
FOR001AKG	53, 57, 145
FOR001AKP	53, 57, 145
FOR001B	52, 56, 64, 144
FOR001BKF	53, 57, 145
FOR001BKFGVM1	365
FOR001BKG	53, 57, 145
FOR001BKP	53, 57, 145
FOR001BKPGVM1	365
FOR001C	52, 56, 144
FOR001CKF	53, 57, 145
FOR001CKFGVM1	365
FOR001CKG	53, 57, 145
FOR001CKP	53, 57, 145
FOR001CKPGVM1	365
FOR001S	52, 56, 64, 144
FOR002A	48, 52, 56, 144
FOR002B	48, 52, 56, 144
FOR002C	48, 52, 56, 144
FOR003B	62, 64
FOR003BKF	64
FOR003BKF1	62
FOR003BKG	64
FOR003BKG1	62
FOR003BKP	64
FOR003BKP1	62
FOR003C	62, 64
FOR003CKF	64
FOR003CKF1	62
FOR003CKG	64
FOR003CKG1	62
FOR003CKP	64
FOR003CKP1	62
FOR005A	48, 62
FOR005AKF	49
FOR005AKG	49
FOR005AKP	49
FOR005B	48, 62
FOR005BKF	49
FOR005BKFGVM	364

Part Number	Page
FOR005BKFGVM1	364
FOR005BKG	49
FOR005BKP	49
FOR005BKPGVM	364
FOR005BKPGVM1	364
FOR005C	48
FOR005CKF	49
FOR005CKFGVM	364
FOR005CKFGVM1	364
FOR005CKG	49
FOR005CKP	49
FOR005CKPGVM	364
FOR005CKPGVM1	364
FOR005S	48, 62
HILFR05	107, 108, 277, 347, 349
HILFR05F	48, 62, 341
HILFR05 / HILFR05F	42, 52, 56, 64, 65, 71, 73, 75, 78, 80, 91, 94, 97, 99, 103, 121, 134, 140, 144, 153, 155, 157, 166, 172, 176, 180, 183, 189, 190, 192, 193, 199, 201, 205, 224, 229, 253, 254, 259, 261, 263, 268, 272, 275, 284, 287, 329, 332, 334, 337, 339
HILFR10	107, 108, 277, 347, 349
HILFR10F	48, 62, 341
HILFR10 / HILFR10F	42, 52, 56, 64, 65, 71, 73, 75, 78, 80, 91, 94, 97, 99, 103, 121, 134, 140, 144, 153, 155, 157, 166, 172, 176, 180, 183, 189, 190, 192, 193, 199, 201, 205, 224, 229, 253, 254, 259, 261, 263, 268, 272, 275, 284, 287, 329, 332, 334, 337, 339
HILFR15	107, 108, 277, 347, 349
HILFR15F	48, 62, 341
HILFR15 / HILFR15F	42, 52, 56, 64, 65, 71, 73, 75, 78, 80, 91, 94, 97, 99, 103, 121, 134, 140, 144, 153, 155, 157, 166, 172, 176, 180, 183, 189, 190, 192, 193, 199, 201, 205, 224, 229, 253, 254, 259, 261, 263, 268, 272, 275, 284, 287, 329, 332, 334, 337, 339
HOLD004BD/S	67, 68, 86, 87, 105, 106
HOLD004BKF1	87
HOLD004BKG1	87
HOLD004BKG2	86
HOLD004BN/S	67, 68, 86, 87, 105, 106
HOLD004CD/S	67, 68, 86, 87, 105, 106
HOLD004CKF1	87
HOLD004CKG1	87
HOLD004CKG2	86
HOLD004CN/S	67, 68, 86, 87, 105, 106
HOLD005A	67, 86, 105
HOLD005BKF	68, 106
HOLD005BKG	68, 106
HOLD005CKF	68, 106

Part Number	Page
HOLD005CKG	68, 106
HOLD006B	82, 84, 101
HOLD006BKF	82, 84, 101
HOLD006BKG	82, 84, 101
HOLD006C	82, 84, 101
HOLD006CKF	82, 84, 101
HOLD006CKG	82, 84, 101
HOLD006D	82, 84, 101
HOLD006DKF	82, 84, 101
HOLD006DKG	82, 84, 101
HOLD007	67, 105
HOLD007BKF	67, 105
HOLD007BKG	67, 105
HOLD007CKF	67, 105
HOLD007CKG	67, 105
HOLD008B	66, 69, 103, 104, 203
HOLD008BKF	66, 104
HOLD008BKF1	69
HOLD008BKG	66, 104
HOLD008BKG1	69
HOLD008C	66, 69, 103, 104
HOLD008CKF	66, 104
HOLD008CKF1	69
HOLD008CKG	66, 104
HOLD008CKG1	69
HOLD009	66, 69, 104
HOLD010	82, 84, 101
HOLD020A	71, 73, 75, 78, 91, 94, 97, 103, 134, 140
HOLD020B	71, 73, 75, 78, 91, 94, 97, 103, 134, 140
HOLD020BKF	103
HOLD020BKG	103
HOLD020BKP	103
HOLD020C	71, 73, 78, 91, 97, 103, 140
HOLD020CKF	103
HOLD020CKG	103
HOLD020CKP	103
HOLD020S	71, 73, 78, 91, 97, 103, 140
HOLD021A	75, 78, 91, 94, 97, 134, 140
HOLD021AKF	79, 98
HOLD021AKF1	76, 95
HOLD021AKF2	135
HOLD021AKF3	92, 141
HOLD021AKG	79, 98
HOLD021AKG1	76, 95
HOLD021AKG2	135
HOLD021AKG3	92, 141
HOLD021AKP	79, 98
HOLD021AKP1	76, 95
HOLD021AKP2	135
HOLD021AKP3	92, 141
HOLD021B	75, 78, 91, 94, 97, 134, 140
HOLD021BKF	79, 98
HOLD021BKF1	76, 95
HOLD021BKF2	135
HOLD021BKF3	92, 141
HOLD021BKG	79, 98



Product Codes

Part Number	Page
HOLD021BKG1	76, 95
HOLD021BKG2	135
HOLD021BKG3	92, 141
HOLD021BKP	79, 98
HOLD021BKP1	76, 95
HOLD021BKP2	135
HOLD021BKP3	92, 141
HOLD021C	75, 78, 91, 94, 97, 134, 140
HOLD021CKF	79, 98
HOLD021CKF1	76, 95
HOLD021CKF1GVM1	368
HOLD021CKF2	135
HOLD021CKF2GVM1	366
HOLD021CKF3	92, 141
HOLD021CKF3GVM	367, 369
HOLD021CKF3GVM1	367, 369
HOLD021CKFGVM1	366
HOLD021CKG	79, 98
HOLD021CKG1	76, 95
HOLD021CKG2	135
HOLD021CKG3	92, 141
HOLD021CKP	79, 98
HOLD021CKP1	76, 95
HOLD021CKP1GVM1	368
HOLD021CKP2	135
HOLD021CKP2GVM1	366
HOLD021CKP3	92, 141
HOLD021CKP3GVM	367, 369
HOLD021CKP3GVM1	367, 369
HOLD021CKPGVM1	366
HOLD021D	75, 78, 91, 94, 97, 134, 140
HOLD021DKF	79, 98
HOLD021DKF1	76, 95
HOLD021DKF1GVM1	368
HOLD021DKF2	135
HOLD021DKF2GVM1	366
HOLD021DKF3	92, 141
HOLD021DKF3GVM	367, 369
HOLD021DKF3GVM1	367, 369
HOLD021DKFGVM1	366
HOLD021DKG	79, 98
HOLD021DKG1	76, 95
HOLD021DKG2	135
HOLD021DKG3	92, 141
HOLD021DKP	79, 98
HOLD021DKP1	76, 95
HOLD021DKP1GVM1	368
HOLD021DKP2	135
HOLD021DKP2GVM1	366
HOLD021DKP3	92, 141
HOLD021DKP3GVM	367, 369
HOLD021DKP3GVM1	367, 369
HOLD021DKPGVM1	366
HOLD022A	71, 73
HOLD022AKF	71, 73
HOLD022AKG	71, 73
HOLD022AKP	71, 73
HOLD022B	71, 73

Part Number	Page
HOLD022BKF	71, 73
HOLD022BKG	71, 73
HOLD022BKP	71, 73
HOLD022C	71, 73
HOLD022CKF	71, 73
HOLD022CKG	71, 73
HOLD022CKP	71, 73
HOLD022S	71, 73
HOLD022SKF	71, 73
HOLD022SKG	71, 73
HOLD022SKP	71, 73
HOLD023B	80, 99
HOLD023BKG	80, 99
HOLD023C	80, 99
HOLD023CKG	80, 99
HYUND003B	89
HYUND003BKG	89
HYUND004	89
IAIRFRESHBOX	37
IALK001	27
IALK001	35
IAPKIT	27
IAREALED001	18
IAP001	192, 193
IAWNING1.4M	21
IAWNING2.5M	21
IAWNING2.5MROOM	21
IAWNING2.5MWALL	21
IAWNING2M	21
IAWNING2MROOM	21
IAWNING2MWALL	21
IAWNINGQR	21
IAWNINGQR HOOK	21
IAWNINGPART001	356
IAWNINGPART002	356
IAWNINGPART003	356
IAWNINGPART004	356
IAWNINGPART005	356
IAWNINGPART006	356
IAWNINGPART007	356
IAWNINGPART008	356
IAWNINGPART009	356
IAWNINGPART010	356
IAWNINGSPARE001	356
IAWNINGSPARE002	356
IAWNINGSPARE003	356
IAWNINGSPARE004	356
IAWNINGSPARE005	356
IAWNINGSPARE006	18, 356
IAWNINGSPARE007	356
IAWNINGSPARE008	356
IAWNINGSPARE009	21, 356
IAWNINGSPARE010	356
IAWNINGSPARE011	356
IAWNINGSPARE012	356
IAWNINGSPARE013	356
IAWNINGSPARE014	356
IAXE001	17

Part Number	Page
IAXE002	17
IBATISO	35
IBLOCK	11
IBOOK001	37
IBOTTLE001	37
IBOTTLE002	37
IBOW	11
IBTBAGS	16
IBTRAY050	41, 170, 174
IBTRAY054	45, 46, 50, 54, 142
IBTRAY056	283
IBTRAY057	74
IBTRAY064	328, 331
IBTRAYTUB	27
IBUSHTOILET	16
ICAMBER12	40, 225, 230, 250, 251
ICAMBER14	161, 202, 239, 249
ICARGOBAG001	16
ICARGOBAG001	32
ICHAIRHA004	15
ICHAIRL003	15
ICHAIRMS	15
ICHAIRSA005	15
ICOMPRESSOR003	12
ICOMPRESSOR004	12
ICOMPRESSOR AIR LINE	358
ICR003	209, 213, 219, 221
ICSC011F	206
ICSC011F3/4	206
ICSC011R	206
ICSC019F	296, 299, 303, 311
ICSC019F3/4	296, 299, 303
ICSC019R	299, 311
ICSC019SCF	296
ICSC031F	179, 182
ICSC031R	179, 182
ICSC033F	274
ICSC033R	274
ICSC038F	55, 143
ICSC038R	55, 143
ICSC040F	70, 72, 74, 77, 93, 96, 102
ICSC040R	74, 77, 93, 96
ICSC042F	191
ICSC042R	191
ICSC043F	283, 286
ICSC043R	283, 286
ICSC047F	328, 331
ICSC047R	328, 331
ICSC048F	188
ICSC048MYR	188
ICSC048R	188
ICSC049R	70, 72, 102
ICSC050F	171, 175
ICSC050R	171, 175
ICSC051F	267, 271
ICSC051R	267, 271
ICSC053F	260

Part Number	Page
ICSC053R	260
ICSC054F	47, 51, 61, 63, 143
ICSC054R	61, 63
ICSC055R	45, 47, 51, 143
ICSC059F	154, 156
ICSC059R	154, 156
ICSC060F	346, 348
ICSC060R	346, 348
ICSC069F	45
ICSC070F	242
ICSC070R	242
ICSC074F	90, 139
ICSC074R	90, 139
ICSCLOAD	88
IDBM001	27
IDCDC40	27
IDCDCSA	27
IDCDCSOLAR	27
IDD100	292
IDIFFBRE	12, 41, 45, 47, 51, 55, 58, 61, 63, 70, 72, 74, 77, 81, 83, 85, 90, 93, 96, 100, 102, 110, 112, 118, 125, 130, 134, 139, 143, 146, 154, 156, 158, 159, 171, 175, 179, 182, 188, 191, 194, 198, 204, 206, 207, 216, 228, 231, 236, 242, 244, 248, 252, 258, 260, 262, 267, 271, 274, 278, 283, 286, 288, 291, 293, 296, 299, 303, 307, 311, 314, 320, 328, 331, 334, 336, 338, 340, 346, 348
IDM009	243
IDOC003	209, 213, 219, 221
IDRAG	11
IDUFBAG001	16
IDUFBAG001	32
IEBC001	27
IENSUITE	21
IEX019DPF	299
IEX039	142
IEX048	188, 228
IEX051	266, 270
IEX054	46, 50, 142
IEX056	283
IEX057	74
IEX058	93
IEX060	346
IEX064	328, 331
IEX067	41, 170, 174
IEX069	45
IEXH4075	241, 358
IEXHAUST002	311
IEXHAUST006	206, 207
IEXHAUST007	54, 142
IEXHAUST009	303
IEXHAUST010	291
IEXHAUST011	194
IEXHAUST012	191



Product Codes

Part Number	Page
IEXHAUST013	299
IEXHAUST014	58, 146
IEXHAUST015	58, 146
IEXHAUST016	96
IEXHAUST017	77
IEXHAUST018	179
IEXHAUST019	179
IFAK001	17, 35
IFAK002	17
IFIRE EXTINGUISHER	35
IFRIDGE30	22
IFRIDGE30 BAG	22
IFRIDGE40	22
IFRIDGE40 BAG	22
IFRIDGE50	22
IFRIDGE50 BAG	22
IFRIDGE65	22
IFRIDGE 65 74 BAG	22
IFRIDGE74	22
IFRIDGESLIDE001	22
IFRIDGESLIDE001	28
IFRIDGESLIDE002	22
IFRIDGESLIDE002	28
IFRIDGESPARE001	357
IFRIDGESPARE002	357
IFRIDGESPARE003	357
IFRIDGESPARE004	357
IFRIDGESPARE005	357
IFRIDGESPARE006	357
IFRIDGESPARE007	357
IFRIDGESPARE008	357
IFRIDGESPARE009	357
IFRIDGESPARE010	357
IFRIDGESPARE011	357
IFRIDGESPARE012	357
IFRIDGESPARE013	357
IFRIDGESPARE014	357
IFRIDGESPARE015	357
IFRIDGESPARE016	357
IFRIDGESPARE017	357
IFRIDGESPARE018	357
IFRIDGESPARE019	357
IFRIDGESPARE020	357
IFRIDGESPARE021	357
IFRIDGESPARE022	357
IFRIDGESPARE023	357
IFRIDGESPARE024	357
IFRIDGESPARE025	357
IFRIDGESPARE026	357
IFRIDGESPARE027	357
IFRIDGESPARE028	357
IFRIDGESTAND001	22
IFRIDGE STRAPS	22
IFT-MUDFLAP	35
IGLOVES	11
IHCLEAN	17
IHCLEANBOX	17
IHEADLAMP002	18

Part Number	Page
IHDIBULB	354
IHIGHLIFT001	13
IHIGHLIFT002	13
IHIGHLIFT003	13
IHIGHLIFT004	13
IHOOK BOW	11
IHVFLAG	13
IHVFLAG	35
ILANTERN001	18
ILANTERN002	18
ILANTERN003	18
ILBDR001B	24
ILBDR001BM	24
ILBDR002B	24, 338, 340
ILBDR002BM	24, 338, 340
ILBSR000B	24
ILBSR001	25
ILBSR001B	24
ILBSR001BW	24
ILBSR001C	25
ILBSR002	25
ILBSR002B	24
ILBSR002BW	24
ILBSR002C	25
ILBSR003	25
ILBSR003B	24, 110, 116, 118
ILBSR003BW	24, 252
ILBSR003C	25
ILBSR004	25
ILBSR005B	24
ILC7AMBER	25
ILC7BLACK	25
ILC7BLUE	25
ILC7CLEAR	25
ILC9AMBER	25
ILC9BLACK	25
ILC9BLUE	25
ILC9CLEAR	25
ILCB7AMBER	25
ILCB7BLACK	25
ILCB7BLUE	25
ILCB7CLEAR	25
ILED20B	110, 116, 252, 338, 340
ILED20BA	110, 116, 252, 338, 340
ILED20BF	110, 116, 252, 338, 340
ILED20BFA	110, 116, 252, 338, 340
ILED20BFR	110, 116, 252, 338, 340
ILED80B	110, 116, 118, 338, 340
ILED5X7	23
ILED7C	23
ILED7M	23
ILED80BA	110, 116, 118, 338, 340
ILED80BF	110, 116, 118, 338, 340
ILED80BFA	110, 116, 118, 338, 340
ILED9C	23
ILED9M	23
ILED20B	26
ILED20BA	26

Part Number	Page
ILED20BF	26
ILED20BFA	26
ILED20BFR	26
ILED80B	26
ILED80BA	26
ILED80BF	26
ILED80BFA	26
ILED180F	25
ILED180S	25
ILEDBLAST2C	23
ILEDBLAST2S	23
ILEDBLASTMOUNT	354
ILEDCOMETMOUNT	354
ILEDCOSMO	26
ILEDDIMMER	18
ILEDSB	26
ILEDSTRIP	18
ILEDUNI3	26
ILEDUNIS	26
ILEDWL10	26, 338, 340
ILEDWL10FA	26, 338, 340
ILEDWLC	18
ILWA001	27
ILWA001	35
IMALLET	17
IMAZ001B	344, 345
IMAZ001BKF	344
IMAZ001BKF1	345
IMAZ001BKG	344
IMAZ001BKG1	345
IMAZ002B	344, 345
IMC001	30
IMC002	30
IMC003	30
IMC004	30
IMC005	30
IMC006	30
IMCAPRIBN06	36
IMCAPRIBN07	36
IMCAPRIBN08	36
IMCAPRIBN09	36
IMCAPRIBN10	36
IMCOOPBN05	36
IMCOOPBN06	36
IMCOOPBN07	36
IMCOOPBN08	36
IMCOOPBN09	36
IMCOOPBN10	36
IMEGATOM	23
IMTS001M2XL	36
IMTS001M3XL	36
IMTS001M5XL	36
IMTS001ML	36
IMTS001MM	36
IMTS001MS	36
IMTS001MXL	36
IMTS001WL	36
IMTS001WM	36

Part Number	Page
IMTS001WS	36
IMTS001WXL	36
IMTS002M2XL	36
IMTS002M3XL	36
IMTS002M5XL	36
IMTS002ML	36
IMTS002MM	36
IMTS002MS	36
IMTS002MXL	36
INUMBPLATE	37
INUMBPLATESLIM	37
IPL048	188
IPL050	174
IPL056	283
IPL057	70, 74, 77
IPL058	93, 96, 102
IPL060	346, 348
IPL066	46, 50, 54, 61, 63
IPL067	170
IPL070	242
IPL074	90, 139
IPL077	110, 116
IQFSTEP	16
IRECKIT001 BAG	11
IRECKIT002 BAG	11
IRECKIT003	10
IRECKIT004	10
IREVERSECAM001	35
IRL120B	26
IRLB200	32
IRLB250	32
IRLB350	32
IRLB500	32
IRLB600	32
IROOFTENT002	20
IROOFTENT003	20
IROOFTENT ANNEX	20
IROOFTENT TENT	20
IROOFTENTSPARE001	357
IROOFTENTSPARE002	357
IROOFTENTSPARE003	357
IROOFTENTSPARE004	357
IROOFTENTSPARE005	357
IROOFTENTSPARE006	357
IROOFTENTSPARE007	357
IROOFTENTSPARE008	357
IROOFTENTSPARE010	357
IROOFTENTSPARE011	357
IROOFTENTSPARE012	357
IROOFTENTSPARE013	357
IROOFTENTSPARE014	357
IROOFTENTSPARE015	357
IROOFTENTSPARE016	357
IROOFTENTSPARE017	357
IROOFTENTSPARE018	357
IROOFTENTSPARE019	357
IROOFTENTSPARE020	357

Product Codes

Part Number	Page
IRP005	188, 191, 206, 207, 288, 291, 293
IRP019	296, 299, 303, 311
IRP019SC	296
IRP033	274
IRP050	41, 174
IRP051	260, 266, 270
IRP054	46, 50, 54, 61, 63, 142
IRP056	283, 286
IRP057	70, 74
IRP058	70, 72, 74, 77, 93, 96, 102
IRP059	154, 156, 170
IRP064	328, 331
IRP070	242
IRP074	90
IRRCAGE14	34, 125, 206, 207, 216, 293, 299, 303, 307, 311, 320
IRRCAGE14-ALLOY	33, 125, 206, 207, 216, 242, 293, 299, 303, 307, 311, 320
IRRCAGE18	34, 70, 72, 102, 125, 206, 207, 216, 283, 286, 288, 291, 293, 299, 303, 307, 311, 320, 328, 331, 334, 336
IRRCAGE18-ALLOY	33, 70, 72, 102, 125, 206, 207, 216, 283, 286, 288, 291, 293, 299, 303, 307, 311, 320, 328, 331, 334, 336
IRRCAGE22	34, 125, 206, 207, 216, 286, 293, 303, 307, 311, 320
IRRCAGE22-ALLOY	33, 125, 206, 207, 216, 286, 293, 303, 307, 311, 320
IRRCROSSBAR001	33, 356
IRREXT1085	33
IRRFEET001	34, 70, 72
IRRFEET100	34, 206, 207, 242
IRRFEET150	34
IRRFEET125	34, 206, 207, 216, 293, 299, 311, 320, 336
IRRFEET210	34, 125, 216, 303, 307
IRRFEETABS14	34, 45, 47, 51, 55, 74, 77, 90, 93, 96, 139, 143, 171, 175, 188, 266, 271
IRRFEETLC100	34, 288, 291
IRRFEETLC200	34, 283, 286, 334
IRRFEETMUX	34, 102
IRRFEETPRADO150	34, 328, 331
IRROPEN14-ALLOY	33, 125, 206, 207, 216, 242, 299, 303, 307, 320
IRRTENT18	34, 70, 72, 102, 125, 206, 207, 216, 283, 286, 288, 291, 293, 299, 303, 307, 311, 320, 328, 331, 334, 336

Part Number	Page
IRRTENT22	34, 125, 206, 207, 216, 286, 293, 303, 307, 311, 320
IRRTFLAT18-ALLOY	33, 70, 72, 102, 125, 206, 207, 216, 283, 286, 288, 291, 293, 299, 303, 307, 311, 320, 328, 331, 334, 336
IRRTRADE18	34, 70, 72, 102, 125, 206, 207, 216, 283, 286, 288, 291, 293, 299, 303, 307, 311, 320, 328, 331, 334, 336
IRRTRADE18-ALLOY	33, 70, 72, 102, 125, 206, 207, 216, 283, 286, 288, 291, 293, 299, 303, 307, 311, 320, 328, 331, 334, 336
IRRTRADE22	34, 125, 206, 207, 216, 286, 293, 303, 307, 311, 320
IRRTRADE22-ALLOY	33, 125, 206, 207, 216, 286, 293, 303, 307, 311, 320
IRRWHEELCLAMP	34, 356
IRWB001	13
ISAFETYTRI	35
ISB80F	268, 272
ISB200F	284, 287
ISB200R	284, 287
ISB600F	205
ISB600R	205
ISB789F	297, 304, 308
ISB789FW	297, 300, 304, 308, 312
ISB789FWP	297, 300, 304, 308, 312
ISB789RW	298, 300, 304, 308, 312
ISD900	28, 130, 311, 328, 331, 334, 336
ISD1000	28, 125, 206, 207, 216, 283, 286, 288, 291, 293, 320
ISD1300	28, 41, 45, 46, 50, 54, 58, 74, 77, 81, 83, 85, 90, 93, 96, 100, 139, 142, 146, 170, 174, 179, 182, 188, 191, 194, 228, 266, 270, 274, 278, 303, 307, 314, 346, 348
ISEAT COVER	13
ISL6010	43, 48, 52, 56, 59, 60, 67, 68, 75, 78, 80, 82, 84, 86, 87, 91, 94, 97, 99, 101, 105, 106, 121, 134, 140, 144, 147, 149, 173, 177, 190, 192, 193, 195, 196, 197, 222, 223, 224, 256, 265, 268, 272, 275, 277, 279, 280, 281, 339
ISHOVEL001	17
ISHOWER002	16
ISNATCH005	11
ISNATCH006	11
ISNATCHROPE	11

Part Number	Page
ISNORKEL001	274
ISNORKEL003	288, 291
ISNORKEL 3.5" HAT	358
ISNORKEL 3" HAT	358
ISNORKEL004	293
ISNORKEL 4" HAT	358
ISNORKEL005	336
ISNORKEL006	334
ISNORKEL009	296, 307, 314
ISNORKEL010	286
ISNORKEL011	216
ISNORKEL013	206
ISNORKEL015	207
ISNORKEL019	191, 198
ISNORKEL020	179, 182
ISNORKEL021	58
ISNORKEL022	83, 100
ISNORKEL023	296, 299, 303, 311
ISNORKEL024	146
ISNORKEL028	81
ISNORKEL034	46, 50, 54
ISNORKEL034XLT	46, 50, 54
ISNORKEL035	331
ISNORKEL036	70, 72, 74, 77
ISNORKEL037	346, 348
ISNORKEL041	93, 96, 102
ISNORKEL048	188
ISNORKEL050	41, 174
ISNORKEL051	266, 270
ISNORKEL053	260
ISNORKEL056	283
ISNORKEL064	328
ISNORKEL070	242
ISNORKEL074	90
ISNORKEL076N	266
ISNORKELSPARE001	358
ISNORKELSPARE002	358
ISOFSHA001	11
ISOFSHA002	11
ISOLAR120	19
ISOLAR200	19
ISPEEDY	12
ISST001	65, 121, 253, 254, 259, 261, 263, 268, 272, 275, 329, 332, 334, 339
ISST004	284, 287
ISST005	341
ISST007	153, 189, 190, 192, 193, 199, 201, 224, 229
ISST010	42, 155, 157, 166, 172, 176, 180, 183
ISST014	52, 56, 64, 144
ISST017	71, 73, 75, 78, 91, 94, 97, 103, 134, 140
ISST052	113
ISST055	48, 62
ISST075	227
ISWAG001	15

Part Number	Page
ISWAG002	15
ISWAGBAG	15
ISWAGPART001	357
ISWAGPART002	357
ISWAGSPARE001	357
ISWAGSPARE002	357
ITB001	31
ITB002	31
ITB003	31
ITB004	31
ITB005	31
ITB006	31
ITB007	31
ITB009	31
ITBL038	54
ITBL039	54, 142
ITBL040	74, 77
ITBL041	90, 93, 96, 139
ITBL048	188, 228
ITBL050	41, 174
ITBL051	266, 270
ITBL054	46, 50
ITBL060	346, 348
ITBL067	170
ITD900	28, 130, 311, 328, 331, 334, 336
ITD1000	28, 125, 206, 207, 216, 283, 286, 288, 291, 293, 320
ITD1300	28, 41, 45, 46, 50, 54, 58, 74, 77, 81, 83, 85, 90, 93, 96, 100, 139, 142, 146, 170, 174, 179, 182, 188, 191, 194, 228, 266, 270, 274, 278, 303, 307, 314, 346, 348
ITDFK064	328, 331
ITDW004	336
ITDW009	311
ITDW011	206, 207
ITDW012	206, 207
ITDW013	320
ITDW015	293
ITDW016	293
ITDW017	291
ITDW018	288, 291
ITDW019	291
ITDW020	283, 286
ITDW022	303
ITDW023	278
ITDW024	274
ITDW025	194
ITDW026	194
ITDW028	191
ITDW029	191
ITDW031	182
ITDW032	179
ITDW037	45, 46, 50, 54, 142
ITDW038	74, 77, 93, 96

Product Codes

Part Number	Page
ITDW040	348
ITDW048	188, 228
ITDW050	41, 170, 174
ITDW051	266, 270
ITDW060	346
ITDW064	328, 331
ITDW074	90, 139
ITENTBAG001	20
ITENTBAG001	32
ITENTFAN002	18
ITENTLIGHT002	18
ITOILET12	16
ITOILETA+B	16
ITOW	11
ITRACK305	13
ITRACK305	28
ITRACK610	13
ITRACK610	28
ITRACKRING	13
ITRACKRING	28
ITREDS1100	13
ITREE	11
ITSS021	94, 97
ITYRE001	12
ITYRE002	12
ITYRE003	12
ITYRE004	12
ITYRE005	12
ITYRE006	12
ITYRE007	12
ITYRE008	12
IUP001K	274
IUP002K	334
IUP003F	328, 331
IUP003K	258, 328, 331
IUP004F	286
IUP004K	286
IUP006K	194
IUP007E	198
IUP007F	191
IUP007K	191
IUP008K	58, 146
IUP009K	81, 83, 85, 100
IUP010F	182
IUP010K	182
IUP011K	248
IUP012K	348
IUP013K	158, 159
IUP014F	50, 54, 142
IUP014K	50, 54, 63, 142
IUP015K	206, 207
IUP016K	130
IUP050K	41, 170, 174
IWC6T	35
IWFT001	22
IWHL001	27
IWHL002	27
IWHL003	27

Part Number	Page
IWHL004	27
IWINCHEXT	11
IWT001	29
IWT002	29
IWT003	29
IWT004	29
IWT005	29
IWT006	29
IWT007	29
IWT008	29
IWTHOSE	29
JEEP003B	115, 120
JEEP003BKF	109
JEEP003BKG	109
JEEP004BD/S	109
JEEP004BN/S	109
JEEP006B	115
JEEP006BKG	115
JEEP006CKG	115
JEEP007B	120
JEEP007BKG	120
JEEP008B	120
JEEP012B	114
JEEP012BKG	114
JEEP012C	114
JEEP013B	114
JEEP013C	114
JEEP014B	108
JEEP014BKG	108
JEEP014BKG1	108
JEEP014C	108
JEEP015B	108
JEEP016B	109, 115
JEEP017AKG	119
JEEP017AKP	119
JEEP017B	119
JEEP017BKG	119
JEEP017BKP	119
JEEP017C	119
JEEP018A	119
JEEP018B	119
JEEP019B	119
JEEP019BKGL	119
JEEP019BKPL	119
JEEP020B	119
JEEP025B	113
JEEP025BKG	113
JEEP025C	113
JEEP025CKG	113
JEEP026B	113
JEEP026C	113
JEEP029A	117
JEEP029B	117
JEEP029C	117
JEEP030A	117
JEEP030AKG	117
JEEP030AKP	117
JEEP030B	117

Part Number	Page
JEEP030BKG	117
JEEP030BKP	117
JEEP030C	117
JEEP030CKG	117
JEEP030CKP	117
JEEP031B	111
JEEP032B	111
JEEP032BKP	111
JEEP032C	111
JEEP032CKP	111
JEEP032D	111
JEEP032DKP	111
JKBKITL	119
JMC002B	121
JMC002BKF	121
JMC002BKG	121
JMC002BKP	121
JMC002C	121
JMC002CKF	121
JMC002CKG	121
JMC002CKP	121
KEY001	37
KEY002	37
KIA006B	122
KIA007B	122
LADA001B	123
LADA002B	123
LAND005BKF	126
LAND005BKG	126
LAND005BKP	126
LAND006B	126, 127
LAND006BKF	126
LAND006BKG	126
LAND006BKP	126
LAND006C	126, 127
LAND006CKF	126
LAND006CKG	126
LAND006CKP	126
LAND007B	126, 127, 129, 133
LAND007BKF	127
LAND007BKG	127
LAND007BKP	127
LAND007CKF	127
LAND007CKG	127
LAND007CKP	127
LAND008B	126
LAND009B	126, 127, 128, 129, 132, 133
LAND009BKF	128, 129, 133
LAND009BKG	128, 129, 133
LAND009BKP	128, 129, 133
LAND009CKF	128, 129, 133
LAND009CKG	128, 129, 133
LAND009CKP	128, 129, 133
LAND011B	128, 129, 132, 133
LAND011C	128, 129, 132, 133
LAND014B	126, 127, 132
LAND014BKF	132

Part Number	Page
LAND014BKG	132
LAND014CKF	132
LAND014CKG	132
LAND019B	131
LAND019C	131
LAND020B	131
LAND020C	131
LC70F30	297, 300, 304, 308, 312, 318
LCF20	254, 289, 294, 337
LCF30	254, 289, 294, 337
LCPR20	253, 329, 332
LCPR25	253, 329, 332
LCR15	290, 295
LCR30	290, 295
LP2	121, 134, 190, 192, 193, 197, 224, 256, 268, 272, 275, 277, 279, 280, 281
LP3	43, 48, 52, 56, 59, 60, 67, 68, 86, 87, 105, 106, 144, 147, 149, 173, 177, 195, 196, 222, 223, 265, 339, 341
LP3-1	413
LP3-2	413
LP4	136, 163, 165, 168, 181, 183, 185, 186, 187, 215, 217, 312, 315, 319, 321, 322, 324, 325, 326, 327, 347, 349
LP4-1	413
LP4-2	413
LP5	247
LP5-1	413
LP5-2	413
LP7-1	413
LP7-2	413
LP9	298, 300, 304, 308
LP9-1	413
LP9-2	413
LR12V10W	74
LR12V21W	90, 170, 352
LTA001	290, 294
LTA003	209, 213, 219, 221, 292
LTA200	284, 287
MAH001	136, 137
MAH002B	136
MAH002BKG	136
MAH003B	137
MAH003BKG	137
MAZDA005	59, 60, 68, 87, 106, 147, 149
MAZDA006A	60, 149
MAZDA006AKF	60, 149
MAZDA006AKG	60, 149
MAZDA006AKP	60, 149
MAZDA006B	60, 149
MAZDA006BKF	60, 149
MAZDA006BKG	60, 149
MAZDA006BKP	60, 149



Product Codes

Part Number	Page
MAZDA006C	60, 149
MAZDA006CKF	60, 149
MAZDA006CKG	60, 149
MAZDA006CKP	60, 149
MAZDA006D	60, 149
MAZDA006DKF	60, 149
MAZDA006DKG	60, 149
MAZDA006DKP	60, 149
MAZDA014	59, 147
MAZDA041A	59, 147
MAZDA041AKF	59, 147
MAZDA041AKG	59, 147
MAZDA041AKP	59, 147
MAZDA041B	59, 147
MAZDA041BKF	59, 147
MAZDA041BKG	59, 147
MAZDA041BKP	59, 147
MAZDA041C	59, 147
MAZDA041CKF	59, 147
MAZDA041CKG	59, 147
MAZDA041CKP	59, 147
MAZDA041D	59, 147
MAZDA041DKF	59, 147
MAZDA041DKG	59, 147
MAZDA041DKP	59, 147
MERC015B	151
MERC015BKF	151
MERC016B	151
MERC020B	150
MERC021B	150
MERC021BKF	150
MERC021BKG	150
MINING001	35
MINING005	35
MINING008	35
MITSO13	162, 163, 164, 165, 187
MITSO15BKF	186
MITSO15BKF1	185
MITSO15BKG	186
MITSO15BKG1	185
MITSO15C	185, 186
MITSO15CKF	186
MITSO15CKF1	185
MITSO15CKG	186
MITSO15CKG1	185
MITSO18B	163, 165, 168, 185, 186, 187
MITSO18BKF	168
MITSO18BKF1	165, 187
MITSO18BKF2	163
MITSO18BKG	168
MITSO18BKG1	165, 187
MITSO18BKG2	163
MITSO18C	163, 165, 168, 185, 186, 187
MITSO18CKF	168
MITSO18CKF1	165, 187
MITSO18CKF2	163

Part Number	Page
MITSO18CKG	168
MITSO18CKG1	165, 187
MITSO18CKG2	163
MITSO19	162, 163, 164, 165, 167, 168
MITSO20B	155, 157, 162, 164, 167
MITSO20BKF	167
MITSO20BKF1	164
MITSO20BKF2	162
MITSO20BKG	167
MITSO20BKG1	164
MITSO20BKG2	162
MITSO20C	162, 164, 167
MITSO20CKF	167
MITSO20CKF1	164
MITSO20CKF2	162
MITSO20CKG	167
MITSO20CKG1	164
MITSO20CKG2	162
MITSO22B	162, 164, 167
MITSO22BKF	167
MITSO22BKF1	164
MITSO22BKF2	162
MITSO22BKG	167
MITSO22BKG1	164
MITSO22BKG2	162
MITSO25B	169
MITSO31	169
MITSO31BKG	169
MITSO31BKG1	169
MITSO34B	161
MITSO35B	161
MITSO38AKG	160
MITSO38B	160
MITSO38BKG	160
MITSO38C	160
MITSO38CKG	160
MITSO38CKG1	160
MITSO38CKG2	160
MITSO39A	160
MITSO39B	160
MITSO39C	160
MITSO40A	42, 166, 172, 176, 180, 183
MITSO40B	42, 155, 157, 166, 172, 176, 180, 183
MITSO40C	42, 155, 157, 166, 172, 176, 180, 183
MITSO40S	42, 166, 172, 176, 180, 183
MITSO41A	181, 183
MITSO41AKF	181, 184
MITSO41AKG	181, 184
MITSO41B	181, 183
MITSO41BKF	181, 184
MITSO41BKG	181, 184
MITSO41BKP	181, 184
MITSO41C	181, 183
MITSO41CKF	181, 184
MITSO41CKG	181, 184

Part Number	Page
MITSO41CKP	181, 184
MITSO42A	155, 157, 166
MITSO42AKF	166
MITSO42AKG	166
MITSO42B	155, 157, 166
MITSO42BKF	166
MITSO42BKF1	155, 157
MITSO42BKG	166
MITSO42BKG1	155, 157
MITSO42C	155, 157, 166
MITSO42CKF	166
MITSO42CKF1	155, 157
MITSO42CKG	166
MITSO42CKG1	155, 157
MITSO42S	166
MITSO42SKF	166
MITSO42SKG	166
MITSO45B	42, 155, 157, 172, 176, 180, 183
MITSO45C	42, 155, 157, 172, 176, 180, 183
MITSO47A	43, 173, 177
MITSO47AKF	43, 173, 177
MITSO47AKG	43, 173, 177
MITSO47B	43, 173, 177
MITSO47BKF	43, 173, 177
MITSO47BKG	43, 173, 177
MITSO47BKP	43, 173, 177
MITSO47C	43, 173, 177
MITSO47CKF	43, 173, 177
MITSO47CKG	43, 173, 177
MITSO47CKP	43, 173, 177
NAVR20	153, 189, 229
NISS003BD/S	223
NISS003BKG	223
NISS003BN/S	223
NISS004BD/S	222, 223
NISS004BN/S	222, 223
NISS005BD/S	222
NISS005BKG	222
NISS005BN/S	222
NISS007B	220
NISS007BKF	221
NISS007BKG	221
NISS007BKP	221
NISS008B	221
NISS009B	218, 220
NISS009BKF	219, 221
NISS009BKF1	221
NISS009BKG	219, 221
NISS009BKG1	221
NISS009BKP	219, 221
NISS009BKP1	221
NISS009C	208, 212, 215, 218
NISS009CKF	219
NISS009CKG	219
NISS009CKP	219
NISS010B	219, 221

Part Number	Page
NISS010C	209, 219, 221
NISS011CD/S	217
NISS011CKF	217
NISS011CKG	217
NISS011CKP	217
NISS011CN/S	217
NISS011DKF	217
NISS011DKG	217
NISS011DKP	217
NISS012CD/S	215, 217
NISS012CN/S	215, 217
NISS012DD/S	215, 217
NISS012DN/S	215, 217
NISS013	196
NISS014AD/S	195, 196
NISS014AKF	196
NISS014AKG	196
NISS014AN/S	195, 196
NISS014BD/S	195, 196
NISS014BKF	196
NISS014BKG	196
NISS014BN/S	195, 196
NISS014CD/S	195, 196
NISS014CKF	196
NISS014CKG	196
NISS014CN/S	195, 196
NISS017	203
NISS018B	203
NISS018BKF	203
NISS018BKG	203
NISS018CKF	203
NISS018CKG	203
NISS020B	213
NISS020C	209, 213, 219
NISS020CKF	219
NISS020CKG	219
NISS020CKP	219
NISS020D	209, 213, 219
NISS024B	208, 212, 215
NISS024CKF	210
NISS024CKG	210
NISS024CKP	210
NISS024DKF	219
NISS024DKG	219
NISS024DKP	219
NISS025	195
NISS025AKG	195
NISS025BKG	195
NISS025CKG	195
NISS026B	208, 212, 218, 220
NISS026BKF	210, 214, 219, 221
NISS026BKF1	210
NISS026BKF1L	210
NISS026BKFL	210, 214, 219, 221
NISS026BKP	210, 214, 219, 221
NISS026BKP1	210
NISS026BKP1L	210
NISS026BKPL	210, 214, 219, 221



Product Codes

Part Number	Page
NISS026CKF	210, 214, 219
NISS026CKF1	210
NISS026CKFL	214, 219
NISS026CKP	210, 214, 219
NISS026CKP1	210
NISS026CKPL	214, 219
NISS027B	209, 213, 219, 221
NISS027C	209, 213, 219
NISS034B	202
NISS035B	202
NISS036CKF	215
NISS036CKG	215
NISS036CKP	215
NISS036DKF	215
NISS036DKG	215
NISS036DKP	215
NISS037BKF	214
NISS037BKG	214
NISS037BKP	214
NISS037CKF	210, 214
NISS037CKG	210, 214
NISS037CKP	210, 214
NISS037DKF	210, 214
NISS037DKG	210, 214
NISS037DKP	210, 214
NISS038B	225
NISS039B	225
NISS040A	153, 189, 190, 229
NISS040B	153, 189, 190, 193, 201, 224, 229
NISS040C	153, 188, 189, 190, 192, 193, 199, 201, 224, 229
NISS040D	153, 189, 190, 192, 199, 229
NISS041B	192, 193
NISS041BKF	193
NISS041BKF1	192
NISS041BKG	193
NISS041BKG1	192
NISS041BKP	193
NISS041BKP1	192
NISS041C	192, 193
NISS041CKF	193
NISS041CKF1	192
NISS041CKG	193
NISS041CKG1	192
NISS041CKP	193
NISS041CKP1	192
NISS041D	192, 193
NISS041DKF	193
NISS041DKF1	192
NISS041DKG	193
NISS041DKG1	192
NISS041DKP	193
NISS041DKP1	192
NISS042B	199, 201
NISS042BKF	201
NISS042BKF1	199

Part Number	Page
NISS042BKG	201
NISS042BKG1	199
NISS042C	199, 201
NISS042CKF	201
NISS042CKF1	199
NISS042CKG	201
NISS042CKG1	199
NISS043B	208, 212, 218, 220
NISS043BKF	210, 214, 219, 221
NISS043BKF1	210
NISS043BKF1L	210
NISS043BKFL	210, 214, 219, 221
NISS043BKP	210, 214, 219, 221
NISS043BKP1	210
NISS043BKP1L	210
NISS043BKPL	210, 214, 219, 221
NISS043CKF	210, 214, 219
NISS043CKF1	210
NISS043CKFL	214, 219
NISS043CKP	210, 214, 219
NISS043CKP1	210
NISS043CKPL	214, 219
NISS044B	209, 213, 219, 221
NISS044C	209, 213, 219
NISS045A	205
NISS045AKF	205
NISS045AKG	205
NISS045AKP	205
NISS045B	205
NISS045BKF	205
NISS045BKG	205
NISS045BKP	205
NISS045C	205
NISS045CKF	205
NISS045CKG	205
NISS045CKP	205
NISS046A	205
NISS046B	205
NISS046C	205
NISS047B	224
NISS047BKF	224
NISS047BKG	224
NISS047BKP	224
NISS048	197
NISS049B	197
NISS049BKG	197
NISS057B	190
NISS057BKF	190
NISS057BKG	190
NISS057BKP	190
NISS057C	190
NISS057CKF	190
NISS057CKG	190
NISS057CKP	190
NISS058A	153, 189, 229
NISS058B	153, 189, 229
NISS058BKF	153, 189, 229
NISS058BKG	153, 189, 229

Part Number	Page
NISS058BKP	153, 189, 229
NISS058C	153, 189, 229
NISS058CKF	153, 189, 229
NISS058CKG	153, 189, 229
NISS058CKP	153, 189, 229
NISS058D	153, 189, 229
NISS058DKF	153, 189, 229
NISS058DKG	153, 189, 229
NISS058DKP	153, 189, 229
PANHARDO01	289, 294
PANHARDO02	290, 294
PANHARDO03	208, 212, 215, 218, 220
PANHARDO04	209, 213, 219, 221
PANHARDO05	208
PANHARDO06	209
PANHARDO07	289, 294
PANHARDO08	208, 212, 215, 218, 220
PANHARDO09	208
PANHARDO10	119
PANHARDO11	119
PANHARDO13	297, 300, 304, 308, 312
PANHARDO13L	297, 300, 304, 308, 312
PANHARDO15	253, 259, 329, 332, 335
PANHARDO15-KDSS	329, 332, 335
PANHARDO16	284, 287
PANHARDO17	243
PANHARDO17L	243
PANHARDO18	243
PATF15	208, 212, 215, 218, 220
PATF30	208, 212, 215, 218, 220
PATR15	209, 213, 219, 221
PATR30	209, 213, 219, 221
PBC055	48, 62
RAMO15A	227
RAMO15B	227
RAMO15C	227
RAMO16A	227
RAMO16AKP	227
RAMO16B	227
RAMO16BKP	227
RAMO16BKP1	227
RAMO16C	227
RAMO16CKP	227
RAMO16CKP1	227
RENO01B	40, 230
RENO01BKG	40, 230
RENO02B	40, 230
RTB038	46, 50, 54, 142
RTB040	74, 77
RTB041	93, 96
RTB048	188, 228
RTB050	41, 174
RTB051	270
RTB051-P	270
RTB051-SP	266
RTB060	346, 348
RTB067GLS	170
RTB067GLX	170

Part Number	Page
RTB069	45
RTB072	338
RTB073	340
RTB074	90
RTB077JL	116
RTB077JT	110
RTB078	252
RTB080	139
RTBPLATE001	46, 50, 54, 142, 266, 270
RTBPLATE002	74, 77, 93, 96
RTBPLATE048	188, 228
RTBPLATE050	41, 170, 174
RTBSPARE002	354
RTBSPARE003	354
RTBSPARE004	354
RWC077JL	116
SBEXT001	289, 294, 297, 300, 304, 308, 312, 318
SBEXT002	290, 295
SBEXT003	208, 209, 212, 213, 218, 219, 220, 221
SBEXT004	209, 213
SBEXT005	290, 295
SBEXT006	208, 209, 212, 213, 215, 218, 219, 220, 221, 253, 259, 329, 332, 335
SBEXT007	209, 213
SBEXT008	119
SBEXT075	227
SS001	81, 83, 85, 100
SS007	191
SS008	58
SS009	146
SS012	206, 207
SS015	311
SS016	296
SS017	334
SS019	299
SS019SC	296
SS019SC RAIL	296
SS031	179
SS033	274
SS034	346, 348
SS034 RAIL	346, 348
SS039	142
SS042	191
SS044	70, 72, 102
SS044 RAIL	70, 72, 102
SS047	331
SS048	188, 228
SS048 RAIL	188, 228
SS050	41, 170, 174
SS050 RAIL	41, 170, 174
SS051	266, 270
SS051 RAIL	266, 270
SS053	260
SS053 RAIL	260
SS054	46, 50, 54

Product Codes

Part Number	Page
SS054 RAIL	46, 50, 54
SS055	61, 63
SS055 RAIL	61, 63
SS057	74, 77, 93, 96
SS057 RAIL	74, 77, 93, 96
SS059	156
SS072	338
SS073	340
SS074	90
SS074 RAIL	90
SS077JL	116
SS077JT	110
SS078	252
SS079	154
SS080	139
SS080 RAIL	139
SSANG001	235
SSANG002B	235
SSANG002BKF	235
SSANG002BKG	235
SSANG003B	232, 233, 234, 237
SSANG003C	232, 233, 234, 237
SSANG004B	232
SSANG004BKG	232
SSANG004C	232
SSANG004CKG	232
SSANG005B	234
SSANG005BKG	234
SSANG005C	234
SSANG005CKG	234
SSANG006B	233
SSANG006BKG	233
SSANG006C	233
SSANG006CKG	233
SSANG010B	237
SSANG010BKG	237
SSP019SC	296
SSP019SC RAIL	296
SSP056	283
SSP056 RAIL	283
SSP064	328
SSP064 RAIL	328
SSR002	58
SSR003	191
SSR004	334
SSR006	81, 83, 85, 100
SSR007	146
SSR012	206, 207
SSR015	311
SSR016	296
SSR019	299
SSR019SC	296
SSR031	179, 182
SSR033	274
SSR034	346, 348
SSR039	142
SSR042	191
SSR044	70, 72, 102

Part Number	Page
SSR047	331
SSR048	188, 228
SSR050	41, 170, 174
SSR051	266, 270
SSR053	260
SSR054	46, 50, 54
SSR055	61, 63
SSR057	74, 77, 93, 96
SSR074	90
SSR080	139
SSRP011	206
SSRP015	311
SSRP016	296
SSRP019	299
SSRP019SC	296
SSRP056	283
SSRP064	328
ST10RK	405, 406, 408
ST21RK	405, 406, 408
ST38-1	404, 406, 407
ST39	405, 406
ST710RK	405, 406, 407, 408
ST714RK	404
ST720RK	404, 406, 408
ST727RK	405, 406, 408
SUB001B	239
SUB002B	239
SUB003B	239
SUB004B	239
SUB005B	239
SUB006B	239
SUB007BKG	238
SUB009BKG	240
SUB009BKG1	240
SUB011BKG	241
SUZ001BD/S	247
SUZ001BKG	247
SUZ001BN/S	247
SUZ002B	247
SUZ002BD/S	247
SUZ003B	251
SUZ003BKG	251
SUZ004B	251
SUZ005B	250, 251
SUZ005BKG	251
SUZ006B	251
SUZ007B	246
SUZ008B	246
SUZ009B	243, 245
SUZ009BKG	245
SUZ009C	243
SUZ010B	243, 245
SUZ010BKG	243
SUZ010BKGGM	370
SUZ010BKGGM1	370
SUZ010C	243
SUZ010CKG	243
SUZ010CKGGM	370

Part Number	Page
SUZ010CKGGM1	370
SUZ011B	243, 245
SUZ011C	243
SUZ013B	250
SUZ013BKG	250
SUZ015B	250
SUZ016B	250
SUZ016BKG	250
SUZ017B	250
SUZ018B	250
SUZ018BKG	250
SUZ019AKG	249
SUZ019B	249
SUZ019BKG	249
SUZ019C	249
SUZ019CKG	249
SUZ020A	249
SUZ020B	249
SUZ020C	249
TANK001	311
TANK002	274
TANK003	191
TANK004	41, 170, 174, 179, 182
TANK005	179, 182
TANK006	58, 146
TANK007	46, 50, 54, 142
TANK048	188, 228
TANK051	266, 270
TANK057	74, 77, 93, 96
TB038	46, 50, 54, 142
TB040	74, 77
TB041	93, 96
TB048	188, 228
TB050	41, 170, 174
TB051	266, 270
TB077JL	116
TOY001B	325, 327
TOY001BKF	327
TOY001BKG	327
TOY001BKP	327
TOY002B	327
TOY003BKF	325
TOY003BKG	325
TOY003BKP	325
TOY003C	325
TOY004B	324, 326
TOY004BKF	326
TOY004BKG	326
TOY004BKP	326
TOY004C	324, 326
TOY005BKF	324
TOY005BKG	324
TOY005BKP	324
TOY005C	324
TOY006AKF	323
TOY006AKF1	323
TOY006AKF2	321
TOY006AKF3	321

Part Number	Page
TOY006AKG	323
TOY006AKG1	323
TOY006AKG2	321
TOY006AKG3	321
TOY006AKP	323
TOY006AKP1	323
TOY006AKP2	321
TOY006AKP3	321
TOY006B	320, 322
TOY006BKF1	323
TOY006BKF2	321
TOY006BKG1	323
TOY006BKG2	321
TOY006BKP1	323
TOY006BKP2	321
TOY006C	320, 322
TOY006CKF1	323
TOY006CKF2	321
TOY006CKG1	323
TOY006CKG2	321
TOY006CKP1	323
TOY006CKP2	321
TOY006D	320, 322
TOY007AD/S	318, 321, 322
TOY007AN/S	319, 321, 322
TOY007BD/S	318, 321, 322
TOY007BKF1	323
TOY007BKF2	321
TOY007BKG1	323
TOY007BKG2	321
TOY007BKP1	323
TOY007BKP2	321
TOY007BN/S	319, 321, 322
TOY007CD/S	318, 321, 322
TOY007CKF1	323
TOY007CKF2	321
TOY007CKG1	323
TOY007CKG2	321
TOY007CKP1	323
TOY007CKP2	321
TOY007CN/S	321, 322
TOY008B	315, 319
TOY008BKF	315
TOY008BKG	315
TOY008BKP	315
TOY008C	315
TOY008CKF	315
TOY008CKG	315
TOY008CKP	315
TOY009B	315
TOY009C	315
TOY009D	315
TOY009DKF	315
TOY009DKG	315
TOY009DKP	315
TOY009E	315
TOY009EFK	315
TOY009EKG	315



Product Codes

Part Number	Page
TOY009EKP	315
TOY010BD/S	280, 281
TOY010BKF1	281
TOY010BKF2	280
TOY010BKG1	281
TOY010BKG2	280
TOY010BN/S	280, 281
TOY010CD/S	280, 281
TOY010CKF1	281
TOY010CKF2	280
TOY010CKG1	281
TOY010CKG2	280
TOY010CN/S	280, 281
TOY011B	256, 280, 281
TOY011BKF	256
TOY011BKG	256
TOY011C	256, 280, 281
TOY011CKF	256
TOY011CKG	256
TOY012C	289, 294
TOY012CKF1	290, 295
TOY012CKF1L	290, 295
TOY012CKF2	290, 295
TOY012CKF2L	290, 295
TOY012CKP1	290, 295
TOY012CKP1L	290, 295
TOY012CKP2	290, 295
TOY012CKP2L	290, 295
TOY013B	289
TOY013B	292
TOY013B	294
TOY013C	289, 294
TOY013D	289, 294
TOY016AKF	319
TOY016AKG	319
TOY016AKP	319
TOY016BKF	319
TOY016BKG	319
TOY016BKP	319
TOY017A	261, 263
TOY017AKF	263
TOY017AKF1	261
TOY017AKG	263
TOY017AKG1	261
TOY017AKP	263
TOY017AKP1	261
TOY017B	261, 263
TOY017BKF	263
TOY017BKF1	261
TOY017BKG	263
TOY017BKG1	261
TOY017BKP	263
TOY017BKP1	261
TOY017S	261, 263
TOY017SKF	263
TOY017SKG	263
TOY017SKP	263
TOY018B	317

Part Number	Page
TOY018BKF	317
TOY018BKG	317
TOY019B	317
TOY023B	255
TOY023BKF	255
TOY023BKG	255
TOY023C	255
TOY023CKF	255
TOY023CKG	255
TOY024B	289, 294
TOY024BKF	290, 295
TOY024BKG	290, 295
TOY024BKP	290, 295
TOY024C	289, 294
TOY024CKF	290, 295
TOY024CKG	290, 295
TOY024CKP	290, 295
TOY024DKF	290, 295
TOY024DKG	290, 295
TOY024DKP	290, 295
TOY025B	289, 294
TOY025C	289, 292, 294
TOY025D	289, 292, 294
TOY026	255, 256, 279
TOY027A	279
TOY027AKF	279
TOY027AKG	279
TOY027B	279
TOY027BKF	279
TOY027BKG	279
TOY027C	279
TOY027CKF	279
TOY027CKG	279
TOY034B	326
TOY038AKF	254, 337
TOY038AKF1	337
TOY038AKG	254, 337
TOY038AKG1	337
TOY038AKP	254, 337
TOY038AKP1	337
TOY038B	80, 99, 254, 263, 337
TOY038BKF	254, 337
TOY038BKF1	254, 337
TOY038BKG	254, 337
TOY038BKG1	254, 337
TOY038BKP	254, 337
TOY038BKP1	254, 337
TOY038C	80, 99, 121, 254, 337
TOY038CKF	337
TOY038CKF1	337
TOY038CKG	337
TOY038CKG1	337
TOY038CKP	337
TOY038CKP1	337
TOY039A	254, 337
TOY039B	254, 337
TOY039C	254, 337
TOY042	265

Part Number	Page
TOY044C	265
TOY044CKG	265
TOY046A	297, 300, 304, 308, 312, 318
TOY046AKF	305, 309
TOY046AKF1	298
TOY046AKG	305, 309
TOY046AKG1	298
TOY046AKP	305, 309
TOY046AKP1	298
TOY046B	297, 300, 304, 308, 312, 318
TOY046BKF	305, 309
TOY046BKF1	298, 301
TOY046BKG	305, 309
TOY046BKG1	298, 301
TOY046BKP	305, 309
TOY046BKP1	298, 301
TOY046C	297, 300, 304, 308, 312, 318
TOY046CKF	305, 309
TOY046CKF1	298, 301
TOY046CKG	305, 309
TOY046CKG1	298, 301
TOY046CKP	305, 309
TOY046CKP1	298, 301
TOY046DKF	305, 309
TOY046DKF1	298, 301
TOY046DKG	305, 309
TOY046DKG1	298, 301
TOY046DKP	305, 309
TOY046DKP1	298, 301
TOY046EKF	305, 309
TOY046EKF1	298, 301
TOY046EKP	305, 309
TOY046EKP1	298, 301
TOY047A	297, 304, 308
TOY047B	297, 300, 304, 308
TOY047C	297, 300, 304, 308
TOY047CKFGVM	374, 375, 376
TOY047CKFGVM1	374, 375, 376
TOY047CKPGVM	374, 375, 376
TOY047CKPGVM1	374, 375, 376
TOY047D	297, 300, 304, 308
TOY047DKFGVM	374, 375, 376
TOY047DKFGVM1	374, 375, 376
TOY047DKPGVM	374, 375, 376
TOY047DKPGVM1	374, 375, 376
TOY047E	297, 300, 304, 308
TOY047EKFGVM	374, 375, 376
TOY047EKFGVM1	374, 375, 376
TOY047EKPGVM	374, 375, 376
TOY047EKPGVM1	374, 375, 376
TOY048B	316
TOY048BKF	316
TOY048BKG	316
TOY048C	316
TOY048CKF	316

Part Number	Page
TOY048CKG	316
TOY049B	316
TOY049C	316
TOY050	292
TOY050BKF	292
TOY050BKG	292
TOY050BKP	292
TOY050CKF	292
TOY050CKG	292
TOY050CKP	292
TOY050DKF	292
TOY050DKG	292
TOY050DKP	292
TOY051	292
TOY051BKF	292
TOY051BKG	292
TOY051BKP	292
TOY051CKF	292
TOY051CKG	292
TOY051CKP	292
TOY051DKF	292
TOY051DKG	292
TOY051DKP	292
TOY055A	121, 259, 261, 263, 268, 272, 275, 334
TOY055AKF	253, 259, 335
TOY055AKF1	335
TOY055AKG	253, 259, 335
TOY055AKG1	335
TOY055AKP	253, 259, 335
TOY055AKP1	335
TOY055B	253, 259, 261, 263, 268, 272, 275, 334
TOY055BKF	253, 259, 335
TOY055BKF1	335
TOY055BKG	253, 259, 335
TOY055BKG1	335
TOY055BKP	253, 259, 335
TOY055BKP1	335
TOY055C	65, 259, 268, 272, 275, 334
TOY055CKF	253, 259, 335
TOY055CKF1	335
TOY055CKG	253, 259, 335
TOY055CKG1	335
TOY055CKP	253, 259, 335
TOY055CKP1	335
TOY056A	65, 253, 259, 332, 335
TOY056AKF	65
TOY056AKG	65
TOY056B	65, 253, 259, 329, 332, 335
TOY056BKF	65
TOY056BKG	65
TOY056C	65, 253, 329, 332, 335
TOY056CKF	65
TOY056CKG	65
TOY057A	275
TOY057AKF	276
TOY057AKG	276

Product Codes

Part Number	Page
WINCH BLANKET	10, 353
WWB001	353
WWB002	353
WWB003	353
WWB003B	353
WWB004	353
WWB004B	353
WWB005	353
WWB006	353
WWB007	353
WWB008	353
WWB009	353
WWB010	353
WWB011	353

Part Number	Page
WWB012	353
WWB013	353
WWB014	353
WWB015	353
WWB016	353
WWB017	353
WWB018	353
WWB019	353
WWB020	353
WWB021	353
WWB022	353
WWB023	353
WWB024	353
WWB025	353

Part Number	Page
WWB026	353
WWB9500	10
WWB9500SR	10
WWB12000	10
WWB12000SR	10
WWWBRAKE	353
WWWCABLE 12	353
WWWCABLE 95	353
WWWCARTON12	353
WWWCARTON95	353
WWWCLUTCH	353
WWWDRUM	353
WWWDRUMBUSH	353

Part Number	Page
WWWENDPLATE GBOX	353
WWWENDPLATE MOTOR	353
WWWFAIRLEAD	353
WWWHAWSE	10
WWWMOTOR12	353
WWWMOTOR95	353
WWWORING	353
WWWREMOTE WIRELESS	353
WWWROPE001	10
WWWTAG12	353
WWWTAG95	353

Notes



Notes



Terms and Conditions

1. Interpretation

In these Terms and Conditions of Sale ("Terms"), "Goods" means the Goods the subject of the Contract; IRONMAN 4X4 Pty. Ltd. means the entity selling the Goods; "Buyer" means the entity purchasing the Goods; "Contract" means each contract between IRONMAN 4X4 Pty. Ltd. and the Buyer for the sale and purchase of the Goods and "order" includes "offer".

2. Terms and Conditions

The only Terms of the Contract are those agreed to in writing by IRONMAN 4X4 Pty. Ltd. These Terms (to the extent they are not inconsistent with Terms agreed to in writing by IRONMAN 4X4 Pty. Ltd.) and those which are implied or imposed by law (including the Trade Practices Act 1974) to the extent that it is not lawful or possible to exclude them. All other Terms, Conditions and Warranties are expressly excluded. If a conflict arises between the Terms of any order made by the Buyer and these Terms, these Terms will prevail. An agreement to deliver the Goods in instalments is taken to be a separate Contract for each instalment. These Terms and each Contract including them are governed by the laws of New South Wales, and IRONMAN 4X4 Pty. Ltd. and the Buyer submit to the jurisdiction of the courts of that State. If a Term is held to be unenforceable, the remaining Terms will apply.

3. Quotations and Orders

Any quotation made by IRONMAN 4X4 Pty. Ltd. will not be construed or operate as an offer or obligation to sell. IRONMAN 4X4 Pty. Ltd. reserves the right to accept or reject in its absolute discretion any order received by it. The Buyer will not be entitled to cancel or refuse delivery of, or payment for, any order made by it which has been accepted by IRONMAN 4X4 Pty. Ltd.

4. Price

The price payable to IRONMAN 4X4 Pty. Ltd. by the Buyer for the Goods will be the price agreed; failing which it will be the price prevailing at the date the Goods are dispatched by IRONMAN 4X4 Pty. Ltd. for delivery to the Buyer. Prices are payable in Australian currency and exclusive of delivery costs, taxes, duties and other imposts which, if changeable, are payable by the Buyer. Prices quoted in any IRONMAN 4X4 Pty. Ltd. Price List are suggested prices only and may be changed by IRONMAN 4X4 Pty. Ltd. without notice.

5. Payment

The Buyer must pay cash for the Goods on delivery or, at IRONMAN 4X4 Pty. Ltd.'s absolute discretion, strictly within 30 days of delivery. IRONMAN 4X4 Pty. Ltd. will appropriate payments first to outstanding interest and then to outstanding accounts in the date order rendered.

6. Overdue Amounts

If Buyer fails to pay all or part of any amount to IRONMAN 4X4 Pty. Ltd. when due, interest will be payable on that amount from its due date until it is paid in full at a rate equivalent to 2% per annum above the overdraft rate from time to time charged to IRONMAN 4X4 Pty. Ltd. by its principal banker.

7. Delivery

IRONMAN 4X4 Pty. Ltd. will make all reasonable efforts to deliver the Goods on the dates agreed, to the place or carrier designated by the Buyer. IRONMAN 4X4 Pty. Ltd. has the right to make delivery in instalments and to deliver those Goods available for delivery. The Buyer has no right to terminate the Contract because of a delay in delivery.

8. Warranty

IRONMAN 4X4 Pty. Ltd. warrants that its products are manufactured to S.A.E. - Society of Automotive Engineers - specifications for the particular product. IRONMAN 4X4 Pty. Ltd. further warrants that all products sold hereunder are free from defects in material and workmanship.

IRONMAN 4X4 Pty. Ltd. will, at its sole option, repair or replace any products supplied by it which are found to be defective in either materials or workmanship providing that IRONMAN 4X4 Pty. Ltd. is actually notified in writing from the Buyer of the alleged defect within ninety (90) days from the date of invoice. Any claim not made within this period shall conclusively be deemed waived by the Buyer. Repair or replacement is preconditioned on the examination of the Goods by IRONMAN 4X4 Pty. Ltd. and, if requested by IRONMAN 4X4 Pty. Ltd. return of the Goods to IRONMAN 4X4 Pty. Ltd.

No products are to be returned to IRONMAN 4X4 Pty. Ltd. without its written consent, according to procedures outlined in this manual, and the receipt by the Buyer of specific shipping instructions. IRONMAN 4X4 Pty. Ltd. shall not be liable for any expense incurred by the Buyer in order to remedy any defect in its products. IRONMAN 4X4 Pty. Ltd. shall not be liable for any consequential, special, indirect or contingent damage, or expense arising directly or indirectly from any defect in its products or from use of any products. This warranty does not apply to (1) Goods bought for industrial, mining or agricultural use, (2) Goods bought for resupply or resale, (3) Goods no longer required by the Buyer, (4) Goods incorrectly chosen by the Buyer; or (5) Goods modified or altered by the Buyer (including changing colour).

Except as set forth herein, and except as to title, it is expressly agreed (A) that there is no warranty or merchantability or fitness for a particular purpose, nor other warranty express, implied or statutory nor any affirmation of fact, or promises by IRONMAN 4X4 Pty. Ltd. with reference to the goods which extends beyond the specifications, agreed upon by IRONMAN 4X4 Pty. Ltd. and the Buyer and (b) that the Buyer if any, mutually acknowledges that it is purchasing the goods solely on the basis of the commitments of IRONMAN 4X4 Pty. Ltd. expressly set forth herein. No person is authorised to change or add to any of IRONMAN 4X4 Pty. Ltd.'s obligations under this warranty. In no event shall IRONMAN 4X4 Pty. Ltd. be liable for anticipated profits or for incidental or consequential damages.

The Buyer agrees to indemnify and hold IRONMAN 4X4 Pty. Ltd. harmless from and against any loss, injury or damage, to person or property, that extends beyond the warranties set forth above, whether the claims against IRONMAN 4X4 Pty. Ltd. or the damages are incidental or consequential.

1 Year Warranty - Accessories / Mining Accessories / Underbody Protection

2 Year Warranty - Premium Underbody Protection / GVM Upgrades / Load Plus

3 Year Components Warranty - Ice Cube Fridge/Freezers

3 Year 60,000km Warranty - Suspension

5 Year Warranty - Monster Winches, Snorkel

5 Year Compressor Warranty - Ice Cube Fridge/Freezers

Lifetime Limited Warranty - TREDs

IRONMAN 4X4 Pty. Ltd. warrants the original buyer, only when purchased new via authorised IRONMAN 4X4 Pty. Ltd. resellers and distributors, from date of sale.

Product is warranted against defects in material or workmanship that cause the product to perform below the specified limits set by IRONMAN 4X4 Pty. Ltd., to the extent that IRONMAN 4X4 Pty. Ltd. will repair or replace any parts which are found to be defective.

All warranty claims must be submitted via original purchasing store or chain, unless otherwise arranged.

Proof of original purchase must be presented upon request.

Products may require to be returned to IRONMAN 4X4 Pty. Ltd. for assessment or repair. Postage and removal costs involved are not the responsibility of IRONMAN 4X4 Pty. Ltd., and may only be considered upon discretion by IRONMAN 4X4 Pty. Ltd. in the event of such claim being verified.

The warranty does NOT apply where, 1) acts of neglect or misuse are evident, 2) product has been modified, 3) vehicles which are modified or not the recommended vehicle of use, 4) used in racing or competition conditions without the prior consent of IRONMAN 4X4 Pty. Ltd., 5) used beyond the expectations of the original vehicle manufacturer.



Product Codes

Before installation of any product, please ensure you have received the correct parts for your application.

Ordering of the correct parts is the responsibility of the Buyer. Return of a product in an unused condition will attract a 15% restock fee, where IRONMAN 4X4 Pty. Ltd. is not at fault.

Return of used or soiled product, 1) outside warranty period, 2) without fault, will result in refusal of your claim and be returned at the Buyer's expense.

Damage to products through fitment error is not covered under warranty.

9. Damage

The Buyer acknowledges that the Goods leaving IRONMAN 4X4 Pty. Ltd's premises are adequately packed. Claims for damage in transit must be made against the carrier and, while IRONMAN 4X4 Pty. Ltd. will not accept liability for any damage, details of any claim must be promptly advised to IRONMAN 4X4 Pty. Ltd. Prior to acknowledging delivery to the carrier, the Buyer must ensure that the complete consignment has been received as specified in the carrier's note. Any shortage or visible damage to outer packaging must be endorsed on the carrier's note. Any shortages and/or damages must be reported to IRONMAN 4X4 Pty. Ltd. within 72 hours or receipt.

10. Title

10.1 Title to the Goods will not pass to the Buyer until the earlier of:

- (a) IRONMAN 4X4 Pty. Ltd. being paid in full under all Contracts; or
- (b) the sale by the Buyer of the Goods in its ordinary course of business (in which case the Buyer must keep an accurate account of each sale, hold the proceeds of each sale separate from the Buyer's own money and pay IRONMAN 4X4 Pty. Ltd. in full from the proceeds of the purchase price of each sale, despite that the payment is not otherwise due).

10.2 Until title to the Goods passes to the Buyer, the Buyer must:

- (a) hold the Goods as bailed for IRONMAN 4X4 Pty. Ltd. and keep them in good order and condition;
- (b) not remove any markings placed by IRONMAN 4X4 Pty. Ltd. and ensure that the Goods can be readily identified and distinguished from other property in the Buyer's possession; and
- (c) deliver the Goods to IRONMAN 4X4 Pty. Ltd. immediately upon demand and, for this purpose, IRONMAN 4X4 Pty. Ltd. is authorised to enter at any time any premises on which the Goods may be located (the costs incidental to which will be borne by the Buyer).

11. Risk

Risk in the Goods (including insurance responsibility) passes to the Buyer on delivery of the Goods to the place or carrier designated by the Buyer or, if sooner, possession of the Goods passes to the Buyer or its agent.

12. Implied Terms, Limitation of Liability and Buyers Indemnity

12.1 Subject to Clause 2, IRONMAN 4X4 Pty. Ltd's liability for any breach of a condition or warranty imposed or implied by law in respect of any Goods or services which are not of a kind ordinarily acquired for personal, domestic or household use or consumption (provided that this provision does not apply if the Buyer establishes that it is not fair or reasonable for IRONMAN 4X4 Pty. Ltd. to rely on it) will be limited to:

- (a) in the case of Goods supplied, any one or more of the following (as IRONMAN 4X4 Pty. Ltd. may determine):
 - (i) replacement of the Goods or the supply of equivalent goods; (ii) repair of the Goods;
 - (iii) payment of the cost of replacing the Goods or of acquiring or obtaining equivalent goods; or

(iv) payment of the cost of having the Goods repaired; and

(b) in the case of services supplied, any one of the following (as IRONMAN 4X4 Pty. Ltd. may determine);

(i) supplying the services again; or (ii) payment of the costs of having the services supplied again.

12.2 Subject to these Terms, IRONMAN 4X4 Pty. Ltd. will not be liable for any loss, damage, expense or injury of any kind or nature suffered or incurred by the Buyer or any other person, arising out of or in connection with, the Contract (including, without limitation, liability due to negligence or wilful default of IRONMAN 4X4 Pty. Ltd. and any delay in delivery) or any error (whether negligent or not) in information supplied to the Buyer in connection with its subject matter or the use, possession or delivery of the Goods or the exercise by IRONMAN 4X4 Pty. Ltd. of its rights under Clause 16 and the Buyer will indemnify IRONMAN 4X4 Pty. Ltd. in relation to any such loss, damage, expense or injury.

13. Claims

Any claim made by the Buyer must be in writing and contain the particulars specified in the IRONMAN 4X4 Pty. Ltd's 'Application for Exchange or Credit' or 'Applications for Warranty' and be received by IRONMAN 4X4 Pty. Ltd. within 14 days after delivery of the Goods. Subject to the Contract, no claim for credit will be recognised where (1) the Goods are made to special order or the Buyer's specifications or drawings, (2) are no longer required by the Buyer, (3) are returned without the particulars required by this Clause, (4) the Buyer has modified or altered the Goods (including changing colour) or (5) if the IRONMAN 4X4 Pty. Ltd. Catalogue stipulates that return will not be accepted. If the Buyer insists on returning the Goods, it must pay IRONMAN 4X4 Pty. Ltd. a handling fee equal to 40% of the price of the Goods.

14. Force Majeure

Despite any other Term or condition of the Contract, IRONMAN 4X4 Pty. Ltd. will not be liable for any loss, damage, expense or injury of any kind or nature suffered or incurred by the Buyer or any other person, arising out of or in connection with any delay in delivery, or failure to perform any other term or condition of the Contract where that delay or failure is caused by an act of God, fire, labour dispute, civil commotion, intervention of a Government, inability to obtain labour, materials or manufacturing facilities, accidents, interruptions of or delay in transportation or any other cause beyond IRONMAN 4X4 Pty. Ltd's reasonable control

15. Errors or Omissions

IRONMAN 4X4 Pty. Ltd. has the right to correct any clerical errors or omissions, whether in computation or otherwise in any quotation, acknowledgment or document forming part of a Contract.

16. Breach by Buyer

If the Buyer breaches a Contract or IRONMAN 4X4 Pty. Ltd. is not satisfied of a Buyer's ability to pay or otherwise comply with each Contract, IRONMAN 4X4 Pty. Ltd. may by notice to the Buyer, but without compensation, terminate every Contract, suspend or cease deliveries under all Contracts, set-off all deposits against amounts due and made all amounts then outstanding by the Buyer to IRONMAN 4X4 Pty. Ltd. immediately due and payable.

17. Waiver

IRONMAN 4X4 Pty. Ltd's right under the Contract are cumulative and in addition to any other rights. No delay or failure by IRONMAN 4X4 Pty. Ltd. to enforce any right is a waiver of that right. Any waiver by IRONMAN 4X4 Pty. Ltd. of any term or breach of the Contract is not to be taken as a continuing waiver or a waiver of any subsequent breach.



4WD AND TOURING GEAR PRODUCT

ACCESSORIES AND SUSPENSION PRODUCT BY VEHICLE

ACCESSORY SPARE PARTS

PRODUCT INSTALL TIME GUIDE

GVM UPGRADES

SUSPENSION SELECTION AND INFORMATION

SUSPENSION TECHNICAL SPECIFICATIONS

ACCESSORY SELECTION AND INFORMATION

ACCESSORY TECHNICAL SPECIFICATIONS

PRODUCT CODE QUICK REFERENCE

VICTORIA
2-8 Bessemer Drive,
Dandenong South, VIC 3175

NEW SOUTH WALES
22 Yilen Close,
Beresfield, NSW 2322

QUEENSLAND
160 Robinson Road East,
Geebung, QLD 4034

SOUTH AUSTRALIA
36 Millers Road,
Wingfield, SA 5013

WESTERN AUSTRALIA
Cnr Baile Road and Craft Street,
Canning Vale, WA 6155

TO CONTACT IRONMAN 4X4
CALL 1300 731 137 OR VISIT US AT:
www.ironman4x4.com

 Find us on Facebook
facebook.com/Ironman4x4au

